



holder, 3-way, plastic, minimum order quantity 5 or a multiple thereof





product brand name	SIRIUS ACT
product designation	Holders
product type designation	3SU1
manufacturer's article number	
• of the supplied holder	3SU1500-0AA10-0AA0
Actuator	
design of the actuating element	3-way without module
number of contact modules	0
Holder	
material of the holder	Plastic
Display	
number of LED modules	0
General technical data	
product function positive opening	No
product component	
• diode	No
• lamp transformer	No
• light source	No
• series resistor	No
insulation voltage rated value	500 V
degree of pollution	3
surge voltage resistance rated value	6 kV
shock resistance	
• acc. to IEC 60068-2-27	Sinusoidal half-wave 50g / 11 ms
• for railway applications acc. to DIN EN 61373	Category 1, Class B
vibration resistance	
• acc. to IEC 60068-2-6	10 ... 500 Hz: 5g
• for railway applications acc. to DIN EN 61373	Category 1, Class B
mechanical service life (switching cycles) typical	10
reference code acc. to IEC 81346-2	U
Auxiliary circuit	
number of NC contacts for auxiliary contacts	0
number of NO contacts for auxiliary contacts	0
Connections/ Terminals	
tightening torque of the screws in the bracket	1 ... 1.2 N·m
Ambient conditions	
• ambient temperature during operation	-25 ... +70 °C

• ambient temperature during storage	-40 ... +80 °C
environmental category during operation acc. to IEC 60721	3M6, 3S2, 3B2, 3C3, 3K6 (with relative air humidity of 10 ... 95 %, no condensation in operation permitted)
Installation/ mounting/ dimensions	
fastening method	without
• of modules and accessories	Front plate mounting
height	40 mm
width	30 mm
shape of the installation opening	round
installation width	30 mm
installation depth	30.1 mm

Certificates/ approvals

General Product Approval	Declaration of Conformity	Test Certificates
  	 EG-Konf.	Miscellaneous Type Test Certificates/Test Report

Marine / Shipping other

    	Confirmation
---	------------------------------

Further information

- Information- and Downloadcenter (Catalogs, Brochures,...)
<https://www.siemens.com/ic10>
- Industry Mall (Online ordering system)
<https://mall.industry.siemens.com/mall/en/en/Catalog/product?mlfb=3SU1500-0AA10-0AA0>
- Cax online generator
<http://support.automation.siemens.com/WW/CAXorder/default.aspx?lang=en&mlfb=3SU1500-0AA10-0AA0>
- Service&Support (Manuals, Certificates, Characteristics, FAQs,...)
<https://support.industry.siemens.com/cs/ww/en/ps/3SU1500-0AA10-0AA0>
- Image database (product images, 2D dimension drawings, 3D models, device circuit diagrams, EPLAN macros, ...)
http://www.automation.siemens.com/bilddb/cax_de.aspx?mlfb=3SU1500-0AA10-0AA0&lang=en

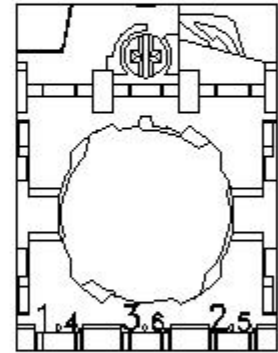
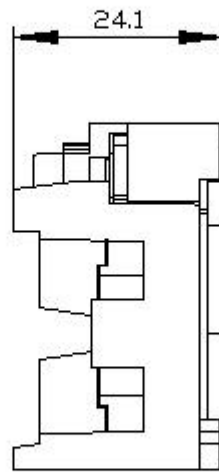
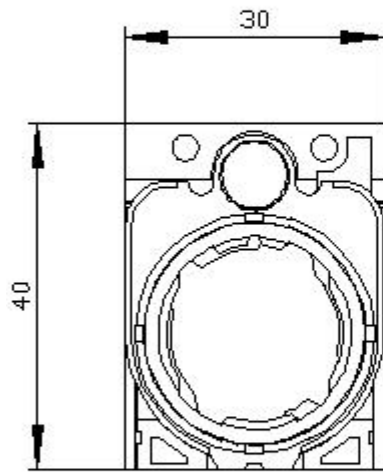

last modified:

12/10/2020 