

Ordering Information

Tuning Fork Switch..... 8110-	
Package Selection	<input type="checkbox"/> <input type="checkbox"/> <input type="checkbox"/> <input type="checkbox"/> <input type="checkbox"/> <input type="checkbox"/>
Switch with FET (P-channel) output:	S P
Switch with FET (N-channel) output:	S N
Switch and junction box	
with FET (P-channel) output:	J P
Switch and junction box	
with FET (N-channel) output:	J N
Switch and 14 - 36 VDC controller	
with 6 Amp relay output:	D R
Switch and 240/120 VAC controller	
with 12 Amp relay output:	A R
Switch with relay output	
60 VAC/VDC, 1 Amp.:	S R
Mounting Thread Selection	<input type="checkbox"/> <input type="checkbox"/> <input type="checkbox"/> <input type="checkbox"/> <input type="checkbox"/> <input type="checkbox"/>
Long probe with 3/4" G mounting threads	L M
Long probe with 3/4" NPT mounting threads	L N
Material Selection	<input type="checkbox"/> <input type="checkbox"/> <input type="checkbox"/> <input type="checkbox"/> <input type="checkbox"/> <input type="checkbox"/>
PP/Ryton probe body and cable:	P
Gasket Selection	<input type="checkbox"/> <input type="checkbox"/> <input type="checkbox"/> <input type="checkbox"/> <input type="checkbox"/> <input type="checkbox"/>
Viton Gasket (M version only)	V
EPDM gasket (M version only):	E
No gasket (SN, SM & LN versions):	O
Complete Order Code 8110-	<input type="checkbox"/> <input type="checkbox"/> <input type="checkbox"/> <input type="checkbox"/> <input type="checkbox"/> <input type="checkbox"/>

bürkert
Easy Fluid Control Systems

Tuning Fork Sensor 8110 Series Owner's Manual



©1998 Bürkert
All rights reserved.
428657-Ind*1/Avr01

SAFETY PRECAUTIONS

Step One

About this Manual:

PLEASE READ THE ENTIRE MANUAL PRIOR TO INSTALLING different models of Tuning Fork sensors from Bürkert, all in the 8110 series. Please refer to the part number located on the sensor label to verify the exact model which you have purchased.

User's Responsibility for Safety:

Bürkert manufactures a wide range of liquid level sensors and technologies. While each of these sensors is designed to operate in a wide variety of applications, it is the user's responsibility to select a sensor model that is appropriate for the application, install it properly, perform tests of the installed system, and maintain all components. The failure to do so could result in property damage or serious injury.

Proper Installation and Handling:

Use a proper sealant with all installations. Never over-tighten the sensor within the fitting, beyond a maximum of 9 N•m torque. Always check for leaks prior to system start-up.

Material Compatibility:

The 8110 series sensor is available in one wetted material version. The bodies of models 8110-SNLM-PO and 8110-SPLM-PO are made of PP (Polypropylene) with the forks made of Ryton (40% glass filled). Make sure that the model which you have selected is compatible between application liquids. To determine the chemical compatibility between the sensor and its application liquids, refer to the Compass Corrosion Guide, available from Compass Publications (619-589-9636).

Temperature and Pressure:

The 8110 series sensor is designed for use in application temperatures up to 90°C, and for use at pressures up to 10 bar (150 psi) @ 25°C, derated @ 0.13 bar (1.67 psi) per °C, above 25°C.

Wiring and Electrical:

The supply voltage used to power the 8110 series sensor should never exceed a maximum of 36 volts DC. Electrical wiring of the sensor should be performed in accordance with all applicable national, state, and local codes.

Flammable, Explosive and Hazardous Applications:

The 8110 series sensor should not be used within flammable or explosive applications. In hazardous applications, use redundant measurement and control points, each having a different sensing technology.

WARNING

Do not squeeze the forks together. Doing so could damage or break the sensor and void the warranty.

INSTALLATION

Step Three

Through Wall Installation:

Bürkert's 8110 series sensors may be installed through the top, side or bottom of a tank wall. The sensor has male threads on either side of a wrench flat. This enables the user to select the sensor's mounting orientation, installed outside of the tank in, or inside of the tank out.

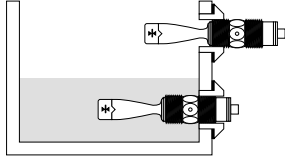

Smart Trak™ Installation:

Bürkert's Smart Trak mounting system is an in-tank fitting which enables users to install up to four Bürkert sensors of any technology, to any depth, along the entire length of a track. Smart Trak may be installed through the top wall of any tank using a standard 2" G tank adapter. If no tank top is available, Bürkert's side mount bracket, 417075 enables Smart Trak to be installed directly to the side wall of a tank.

Switch Pak™ Installation:

Bürkert's Switch Pak mounting system is an in-tank fitting which enables users to install one Bürkert sensor, of any technology to a specified depth. The Bürkert sensor may be installed onto the adapter at the end of the Switch Pak. Switch Pak may be installed through the top wall of any tank using a standard 2" G tank adapter.

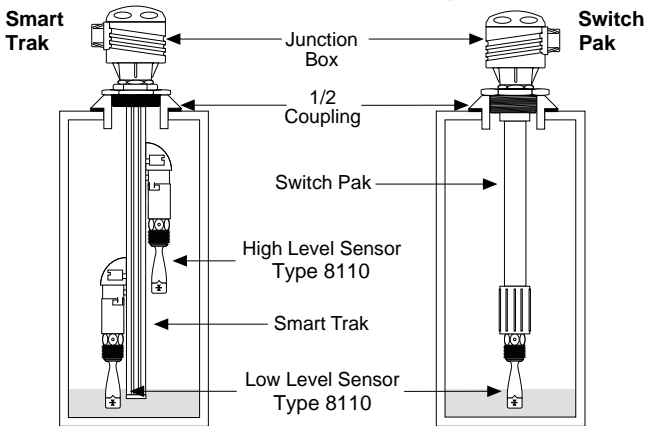

ORIENTATION

Step Four

When installing the 8110, make sure that the forks do not touch the walls of the tank. Consider possible build up along the inner tank wall.

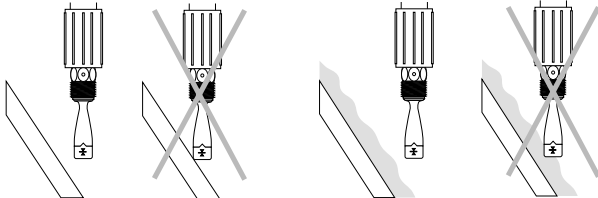

Higher viscosity liquids may build up inside of a flange and cause the 8110 to fail wet.

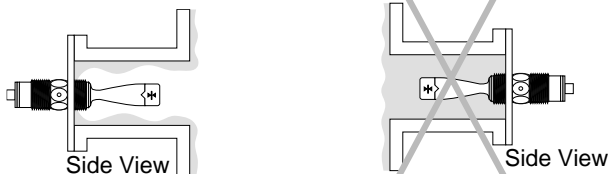

ORIENTATION (follow)

If installing the tuning fork within a pipe, make sure the forks allow the liquid to flow between them and not around them.

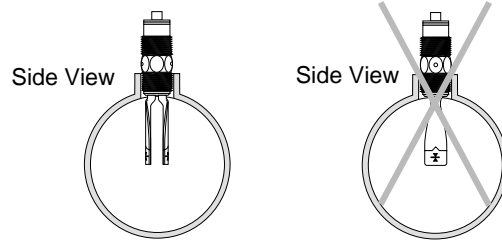

When installing the 8110 horizontally, make sure that the forks orientation is vertical and **not** horizontal.

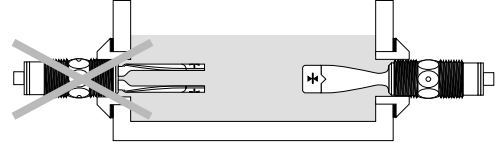

ELECTRICAL

Step Five

Supply Voltage: The supply voltage to the 8110 series sensor should never exceed a maximum of 36 VDC. Bürkert controllers have a built-in 13.5 VDC power supply which provides power to all of Bürkert's electrically powered sensors. Alternative controllers and power supplies, with a minimum output of 12 VDC up to a maximum output of 36 VDC, may also be used with the 8110 series sensor.

Cable Length: Determine the length of cable required between the 8110 series sensor and its point of termination. Allow enough slack to ensure the easy installation, removal and/or maintenance of the sensor. The cable length may be extended up to a maximum of 300 m, using a well-insulated, 20 gauge shielded wire.

Wire Stripping: Using a 10 gauge wire stripper, carefully remove the outer layer of insulation from the last 1-1/4" of the sensor's cable. Unwrap and discard the exposed foil shield from around the signal wires, leaving the drain wire attached if desired. With a 20 gauge wire stripper, remove the last 1/4" of the colored insulation from the signal wires.

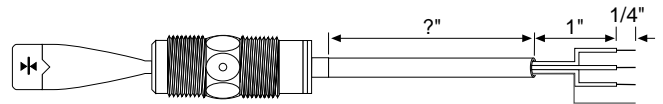

Signal Outputs (Current sensing): The standard method used by Bürkert controllers; this method uses only two wires (Red and Black). The sensor draws 8 mA when it is dry, and 19 mA when wet. NC/NO status must be set by the controller. **The White wire is not used.**

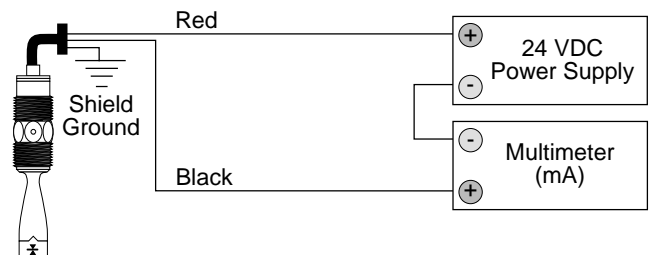

ELECTRICAL (follow)

Signal Outputs (FET switching): Allows the sensor to switch a small DC load on or off directly, using all three wires. Model 8110-SNLM-PO is an NPN type switch, which toggles the negative side of the load; model 8110-SPLM-PO is a PNP type switch for applications where the switch must be on the positive side of the load. In both FET models, the NO/NC status is set by the polarity of the voltage feeding the Red and Black wires, and the White wire connects to the load.

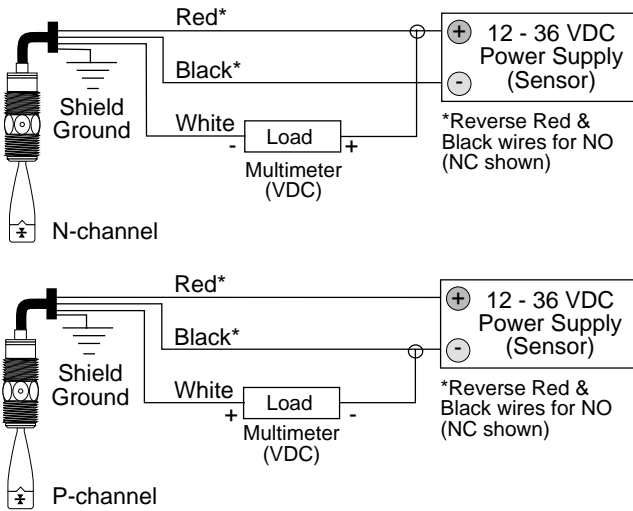

WIRING

Wiring direct to a load, NC operation

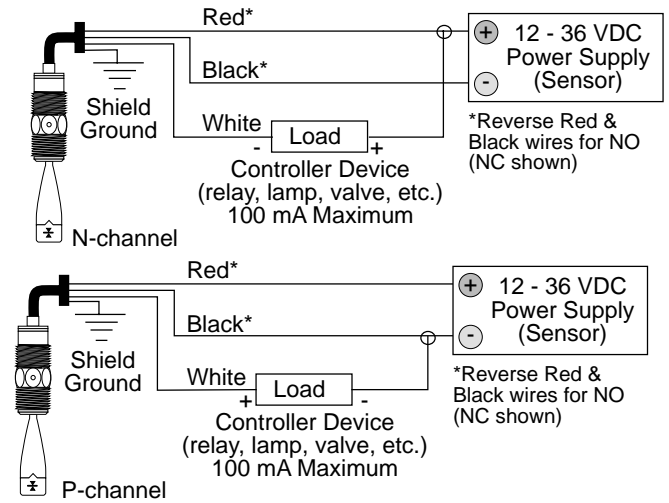

Wiring direct to load, Normally Open operation: 8110-SNLM-PO and 8110-SPLM-PO (FET outputs only):

This is the same as the wiring for Normally Closed operation, except the polarity of the Red and Black connections to the sensor is reversed. *The other connections remain the same; the sensor and device power supplies remain tied in the same polarity as before.* This method will turn the load on when the sensor is wet.

SIGNAL OUTPUT (RELAY SWITCHING):

Wiring direct to a load (Normally open operation):

1. Connect the red to the (+) terminal of a 12-36VDC power supply and the black to the (-) terminal.
2. Connect the white wire directly to the device.
3. Connect the green wire to the HOT/(+) of the devices power supply.
4. Connect the Neutral/(-) of the devices power supply to the other side of the load.

This method will turn the device on when the sensor is wet and turn the device off when the sensor is dry.

Wiring direct to a load (Normally closed operation):

This is the same as the wiring for normally open operation, except the polarity of the red and black connections to the sensor is reversed. Connect the red wire to the (-) terminal of its supply, and the black wire to the (+) terminal. Other connections remain the same; the relay and the device power supplies remain the same polarity as before.

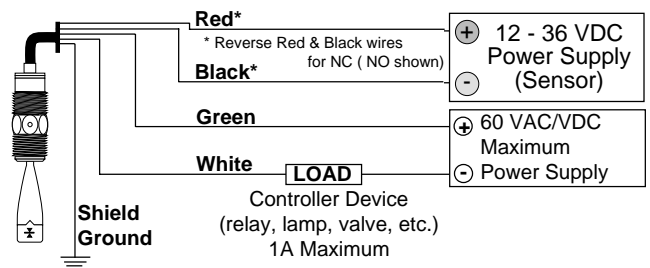

Wiring to a Bürkert relay controller:

The relay output version of the level switch will still interface with Bürkert's compact and remote relay controllers. Connect the red to (+), black to (-) and do not use the white or green wires.

Initialization Sequence: When powering up the 8110, the start-up procedure requires the switch to cycle through a wet condition for 1/2 second in order to determine an initial resonance.

WIRING

Step Six

Wiring to a Bürkert Controller 4 or 20 mA Signal Output

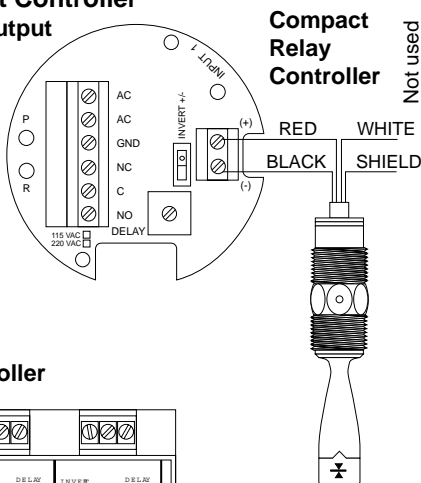

Remote Relay Controller

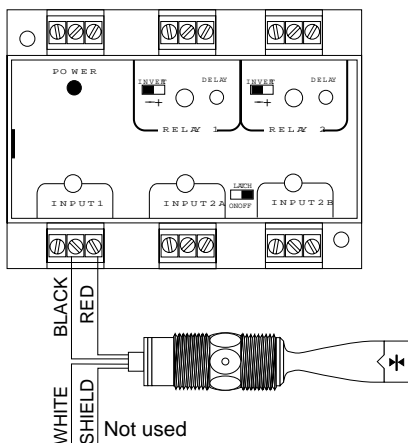

SPECIFICATIONS

Step Two

Accuracy:	± 2 mm in water
Repeatability:	± 1 mm in water
Frequency:	500 Hz (dry)
Supply voltage:	12-36 VDC
Consumption:	Dry: 8 mA Wet: 19 mA
Relay rating:	60VAC/VDC, 1 Amp. maximum
Relay polarity:	Normally open (dry) if power is wired (+) to red and (-) to black. Normally closed (dry) if power is wired (-) to red and (+) to black.
FET switch voltage:	36 VDC max.
FET switch current:	100 mA max.
FET switch output:	Selectable NO or NC states
Temperature range:	F: -40° to 194 ° C: -40° to 90°
Pressure range:	10 bar (150 psi) @ 25°C., derated @ 0,113 bar (1.667 psi) per °C. above 25° C.
Probe material:	PP/Ryton® (40% glass filled)
Probe rating:	NEMA 6 / IP68
Mounting threads:	3/4" BSP
Cable type:	2,5 m, 3-wire, 22 gauge with ground, shield & PP jacket

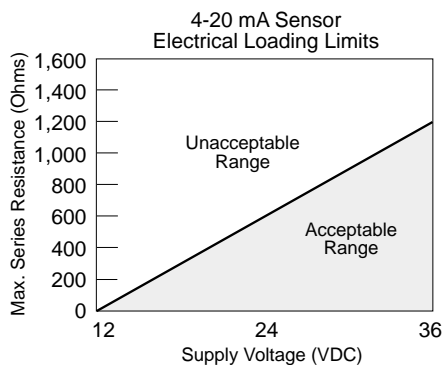
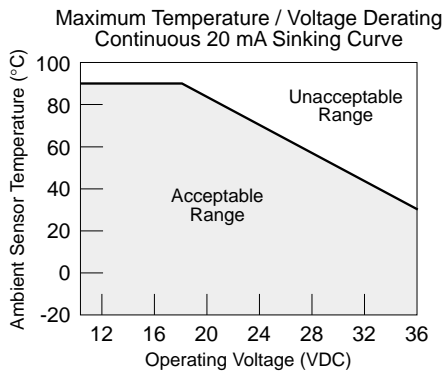
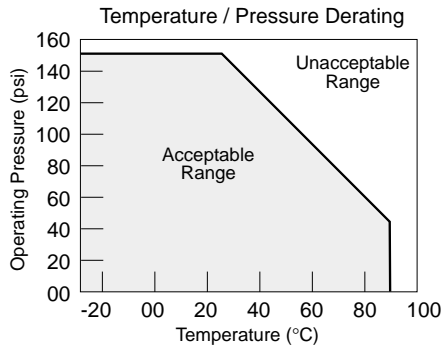

Dimensions

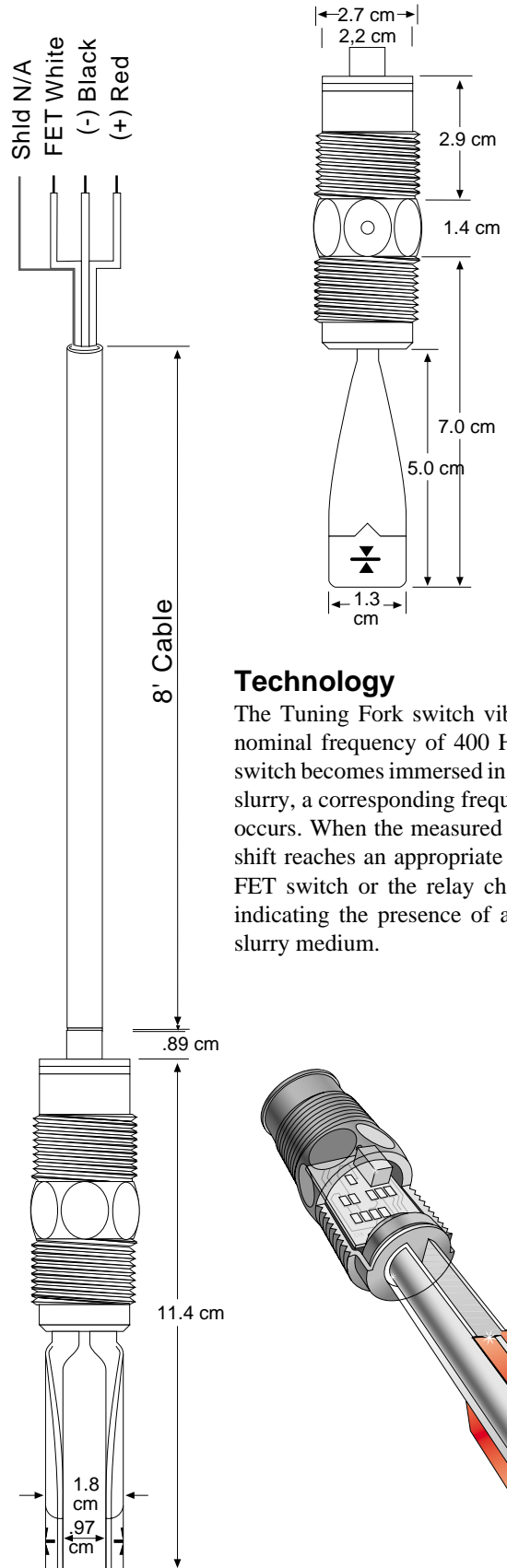

Technology

The Tuning Fork switch vibrates at a nominal frequency of 400 Hz. As the switch becomes immersed in a liquid or slurry, a corresponding frequency shift occurs. When the measured frequency shift reaches an appropriate value, the FET switch or the relay change state indicating the presence of a liquid or slurry medium.

