



Beta

2021

GENERAL PROGRAMME

EN



THE HISTORY OF ITALIAN TOOLS

- 1923 ● Alessandro Ciceri founded "Alessandro Ciceri & Figli", to manufacture iron and steel casts.
- 1939 ● The trademark Beta was registered and the Company became involved mainly in manufacturing professional tools.
- 1960 ● Beta Utensili employed two hundred people, exported their products and stood out as an up-and-coming manufacturer of professional tools.
- 1969 ● The revolutionary orange sheet metal "Tank" trolley was developed; from that moment orange would result in a unique style for the trademark Beta.
- 1971 ● Beta Utensili entered the motor racing world, with a view to testing and developing their products.
- 1975 ● The Company scored their first Formula 1 victory with the orange **March-Beta Utensili** driven by Vittorio Brambilla, who won the Austrian Grand Prix in Zeltweg, in the pouring rain.
- 1980 ● Beta Utensili further penetrated the main European markets, progressively establishing branches in France, Britain, Holland, Spain, Poland and Hungary.
- 1995 ● It took the Company no more than 8 months to have their Quality System certified in accordance with the ISO 9001 standards.
- 2000 ● The launch of the new Beta Utensili catalogue testified to ongoing growth. The range of available products was doubled, and the over 10,000 coded items were divided into 22 product families.
- 2002 ● Beta Utensili's range was further expanded, being supplemented with safety footwear as well as with work and free-time wear, namely the "Beta Work" range.
- 2009 ● Beta further expanded their markets, establishing Beta China.
- 2012 ● Beta Brazil was founded.
- 2016 ● Beta introduces a new modular workshop equipment combination system.
- 2018 ● **BMC** BM S.p.A - leader in the production and sales of crimping terminals and electric connection systems - becomes part of the Beta Group.
- 2019 ● Beta Utensili took over **Abra Beta S.p.A**, a market leader in the production of resin bond reinforced abrasives for grinding and cutting all types of materials and shaft-mounted wheels.
- 2020 ● Beta Utensili took over the leading manufacturer of flexible abrasives, **Elpa Abrasivi S.r.l.**, thereby creating a national skills centre and successfully entering the abrasives market with a new, comprehensive range of professional items. The **Beta Tools USA** branch was established, as a major step towards expansion in the North American market.
- 2021 ● Ongoing growth has translated into the current product range – distributed worldwide –, which exceeds **15,000 coded items**, designed to satisfy the most demanding professionals' requirements.



1939 Forging department



1950 Galvanising department 1955 Shearing department 1960 Shipping warehouse



1969 Tank trolley

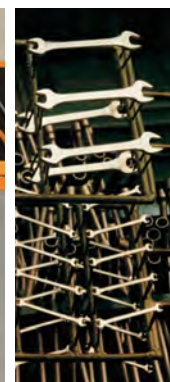

1975 Chrome finishing



1974 Vittorio Brambilla



1980 Engineering department



2002 "BetaWork"



2016 Workshop equipment RSC55



2020 Jorge Navarro



1939



1950



1960



1970



1980



Beta GROUP



8 production
units



More than
800 staff

11
Subsidiaries
9 Beta - 2 BM

Active in more than
100 countries
worldwide with over
250 importers



BETA UTENSILI S.p.A. - 20845 Sovico (MB)
Via A. Volta, 18 - Tel. 039.2077.1 - Fax 039.2010742
www.beta-tools.com

Robur Wire rope accessories:
67039 Sulmona (AQ) Zona industriale - C.da S. Nicola
Tel. 0864.2504.1 - Fax 0864.253132
www.roburitaly.com - info@roburitaly.com

RESEARCH AND DEVELOPMENT



42

Our epoch-making wrench 42 has a new shape. A **stylish, slim** shape enhanced by a slender profile, lighter to the touch. The **strength, resilience and ergonomic design** of the Beta wrench reach even higher values, to provide users with the best possible tool. The manufacturing process is carried out in our **factories in Sovico and Sulmona**, on the basis of state-of-the-art automation technology and the best trained workers.

POWERFUL

Torque values more than doubled compared to the requirements to be satisfied under ISO 1711.

RESILIENT

Remarkable strength: in case of improper use, the wrench buckles, without breaking suddenly and dangerously.

ERGONOMIC

The offset ring has a 15 degree angle to protect the hand. The shape is obtained from a die; it is not bent later.



CAUTION! The new shape of wrench 42 is **perfectly compatible** with all the containers and trays of our epoch-making wrench 42

Beta **EVOR** the evolution of the screwdriver!

The **ergonomic design** fits the palm of the hand perfectly. The large contact surface makes it possible to transmit **maximum force** with minimum effort.

New thermoplastic rubber makes each use – including heavy-duty ones – even more **comfortable**.

The **precision area** allows the screwdriver to be quickly rotated between the fingers.

Beta's tried-and-tested blades ensure unique **elasticity, hardness and wear resistance**, for top-end professional tools.



The brand-new hole on the handle allows the screwdriver to **hang for easy storage**.

The style and size of the tip is printed on the **round cap** for quick identification.



EVOR

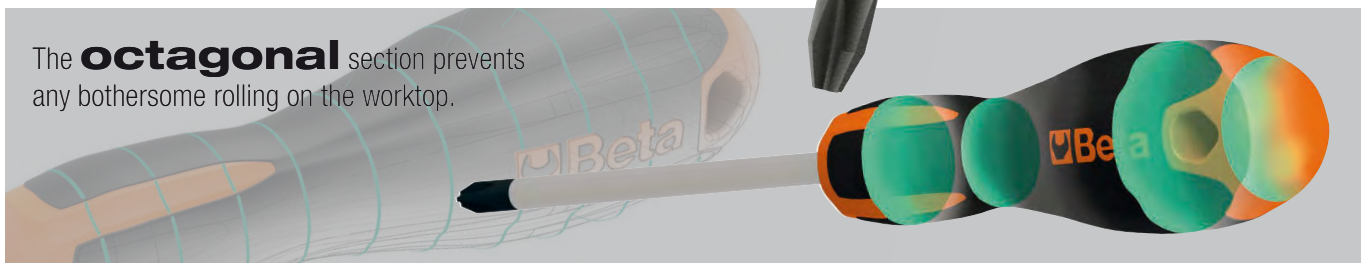

The **octagonal** section prevents any bothersome rolling on the worktop.

RESEARCH AND DEVELOPMENT



1150 HIGH CUTTING POWER

The decentralized pin increases the lever effect, thereby reducing effort, for **powerful cutting capacity**. The thin profile is the name for a safe hold, even in very small spaces.

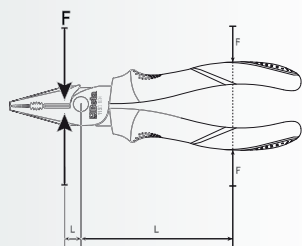

Our range of pliers can now boast **a new finish**, specially developed for industrial maintenance professionals. As well as providing high performance, it also offers a sound alternative to chrome-plated finish thanks to its excellent **quality/price ratio**.



COLOR CODE

A new range of tools for quick identification of what you need!

One colour, one size

One colour, one tip style



Beta CHEMICALS

MADE IN ITALY

Tightening a bolt is not always enough to guarantee secure tightening. Cleaning, lubrication and sealing are also necessary!

One hundred percent Italian production, first-rate raw materials and ongoing innovation of the manufacturing cycles have allowed us to develop top-end high-performance products.

Discover the new **Beta Chemicals** range in the dedicated section.



Beta ABRASIVES

MADE IN ITALY

The new **Beta Abrasives** product family is the name for a comprehensive range of hard and flexible abrasives and an outstanding technical service for professionals, as the result of the manufacturing skills contributed by the market leading companies, **AbraBeta** and **Elpa**.

CERTIFIED QUALITY

In 2018 Beta roller cabs were awarded prestigious **Tüv** certification, after passing severe tests according to protocol EK5/TA5.

Protocol EK5/TA5 deals with 31 well-defined building characteristics, stringent static tests and dynamic behaviour tests. Other tests determine resistance to high and low temperatures, the service life of markings over time and corrosion resistance.

Credit for this achievement is due to the expert design, accurate manufacture and stringent tests Beta relies on for its roller cabs, which has allowed their quality to be acknowledged by end users.



CONTROL AND QUALITY

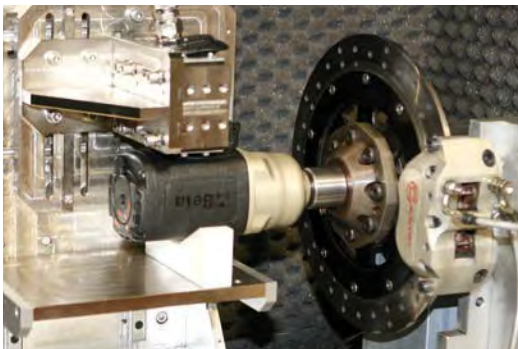
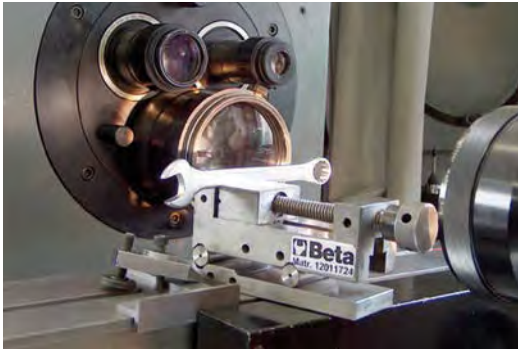

At Beta, quality has a simple, concrete meaning: “that which fully satisfies the needs and expectations of the professional users who rely on our products as an irreplaceable working instrument”. Tools are not only designed and manufactured correctly to fulfil a need, but they must guarantee repeat performances consistently over time.

At Beta, quality goes beyond a merely attentive industrial and sales policy, to permeate every company division, driving us all to achieve increasingly ambitious goals in terms of customer satisfaction. Beta has built its history on this very concept.

**Beta quality,
our most
concrete proof**

**The quality of Beta tools
is a synergy
of age-old techniques
and new technologies.**



Since 1995 our production processes have complied with the ISO 9001 Quality System standards



WORK ORGANIZATION

5S is a workplace organization method of Japanese origin. The name is derived from the western transcription of 5 Japanese words: **seiri, seiton, seiso, seiketsu and shitsuke.**

Following the 5 steps identified by the words allows a systematic, repeatable method to be implemented with a view to optimized working standards and enhanced operating performance.



SEIRI

SORT

Remove all unnecessary items from the workplace; only keep the items you need.



SEITON

SET IN ORDER

Put everything into its proper place: a place for everything and everything in its place.



SEISO

SHINE

Keep the workplace clean and tidy.



SEIKETSU

STANDARDIZE

Establish consistent work practices to keep rationalizing resources and spaces, determining a standard to implement.



SHITSUKE

SUSTAIN

Support and spread this mindset and behaviour across the organization.



BENEFITS



Reduced time loss and improved cost-effectiveness



Enhanced quality and productivity



Fewer work accidents



Greater efficiency



BEFORE



AFTER

EFFECTIVE PRESENCE

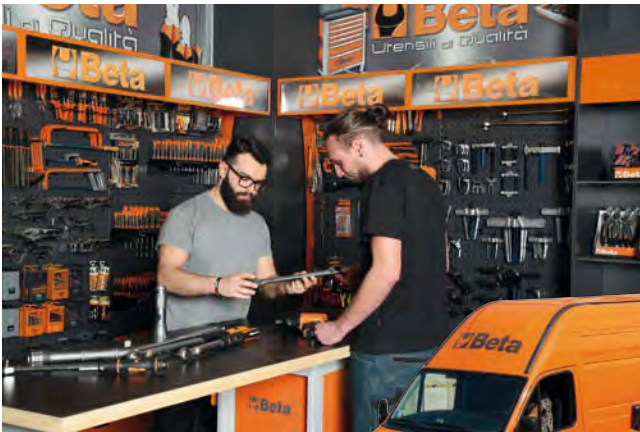

**Demonstration
unit
2020**

RANGE AND ITEMS

Over 15,000 items

The dynamism of the Company has, over the years, helped it to effectively update its product range to promptly respond to the challenges of the global market.

Today the Beta Utensili range comprises over 15,000 items divided into 30 product families, making it one of the most qualified names in the tool market.

Beta produces tools for professional mechanics, from industrial maintenance to car repairs, and for all those whose hobbies are much more than a simple pastime.

30

families

Each professional
need finds
an effective solution

Applications



Automotive



Energy



Industry



Oil & Gas



Aeronautics

www.beta-tools.com

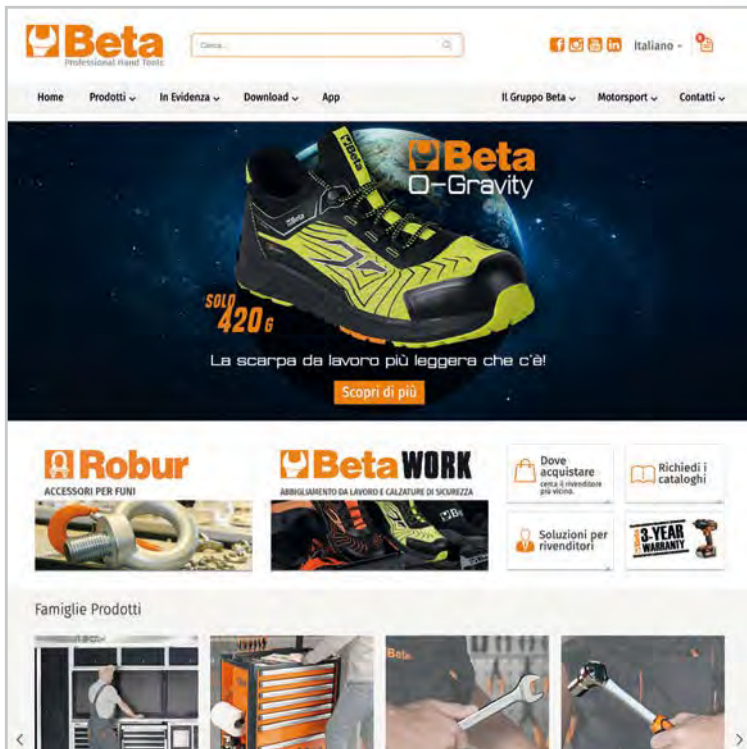

An “easy” and complete website where you can find our updated catalogues, latest news, promotions and all our technical product information (manuals, spare parts and demo videos, which can also be found on YouTube)



Beta supplies different store display solutions to offer customers a “turnkey” service.



A specific app of all the Beta catalogues for IOS and Android.



Autopromotec 2019

WORLDWIDE DISTRIBUTION



Active in over
100 countries
worldwide

**Beta's
far-reaching
distribution
network**
serves
professional users
across the world.

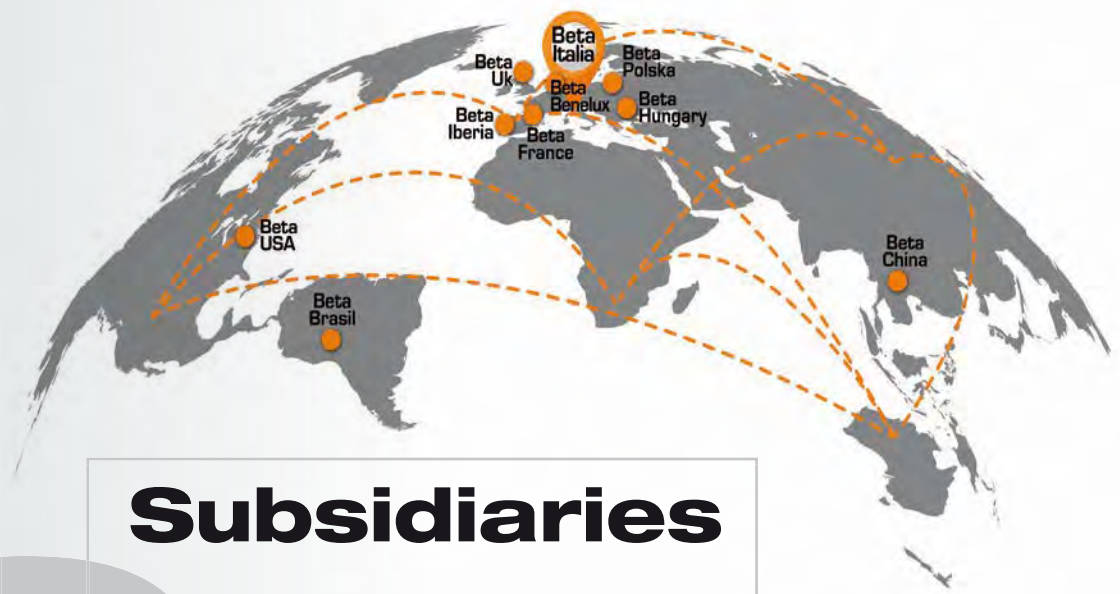

Subsidiaries



Beta China



Beta France



Beta Iberia



Beta Polska



Beta USA



Beta Brasil



Beta Benelux



Beta UK



Beta Hungary



LOGISTICS



**16,000 m²
surface area**



15.000
coded items
and over **27.000**
loading units



**Quick, prompt
and complete
deliveries**



INDEX

WORKSHOP EQUIPMENT **RSC55**



☐ 374+397

RSC55

WORKSHOP EQUIPMENT **C45**



☐ 398+409

CONTAINERS AND ASSORTMENTS



☐ 313+371



☐ 410+497

WRENCHES



☐ 24+30



☐ 36+39



☐ 110+114

SOCKETS AND ACCESSORIES



☐ 73+79



☐ 86+110

TORQUE WRENCHES AND MULTIPLIERS



☐ 63-64



☐ 65+72

SCREWDRIVERS, MALE-END WRENCHES AND BITS



PLIERS AND NIPPERS

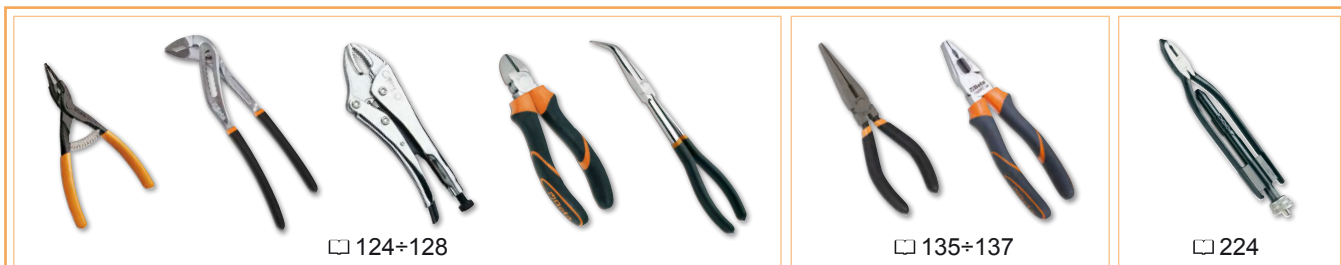

HAMMERS AND CHISELS



DRILLING AND THREADING TOOLS

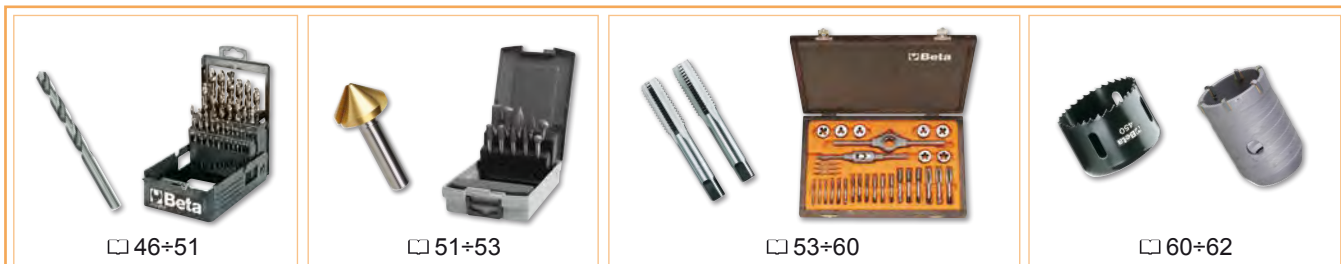

PULLERS



MEASURING AND MARKING TOOLS



CUTTING AND GENERAL MAINTENANCE TOOLS



□ 120



□ 129÷133



□ 149-150



□ 175-176



□ 199



□ 209÷217



□ 225÷239

PLUMBING TOOLS



□ 39÷45

ELECTRONICS AND MICROMECHANICS



□ 122-123



□ 137÷139



□ 142÷144



□ 228-229

ELECTROTECHNICS



□ 132÷134



□ 143



□ 199÷202



□ 221÷225

1000V INSULATED TOOLS



□ 261÷267

STAINLESS STEEL



Beta
INOX
STAINLESS STEEL

□ 275+279

SPARKPROOF TOOLS



□ 280+288

VEHICLE REPAIR



□ 114+122



□ 161+189



□ 150+156



□ 221+225



□ 239+251

MOTORCYCLE TOOLS



□ 252+256

BICYCLE TOOLS



Beta
bike tools

□ 257+260

BATTERY TOOLS

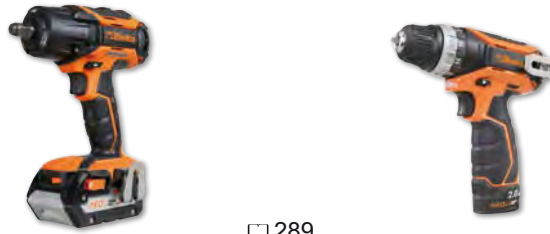

□ 289

PNEUMATIC TOOLS AND ACCESSORIES



□ 290+312

TETHERED TOOLS



□ 268+274

CHEMICAL PRODUCTS

 **Beta**
CHEMICALS



□ 498+502

ABRASIVE TOOLS

 **Beta**
ABRASIVES



□ 503+519

PRODUCTS UNDER THE BRAND NAME BM

 **BM**
GROUP



□ 520+525

ROBUR WIRE ROPE ACCESSORIES



 **Robur**

☐ 592+628

SAFETY FOOTWEAR (AND TECHNICAL SOCKS)





☐ 553+576

WORKWEAR





☐ 577+591

DISPLAY UNITS FOR SALES POINTS





☐ 540+552

BLISTER PACK RANGE



☐ 526+539

BETA COLLECTION







☐ 629+639

KEY READING

item number ----- 42NEW
combination wrenches

tool profile ----- 

in blister pack ----- 

motorcycle tools ----- 

bicycle tools ----- 

size ----- 
 DIN 3113 UNI-ISO 7738

mm	L mm	S1 mm	code number
5,5	95	3,4	5 000421005
6	95	3,4	5 000421006
7	105	3,6	5 000421007
8	116	3,9	5 000421008
9	127	4,2	5 000421009
10	137	4,5	5 000421010
11	148	4,8	5 000421011
12	158	5,1	5 000421012
13	169	5,6	5 000421013
14	180	5,7	5 000421014
15	190	6,0	5 000421015
16	201	6,3	5 000421016
17	212	6,8	5 000421017
18	222	7,0	5 000421018
19	233	7,5	5 000421019

n.° of tools per box -----

n.° of tools per set ----- 

type of packaging -----

set content ----- 42NEW/B9
6-7-8-10-11-13-14-17-19 mm 1 000421064

code number -----

new item 2021 -----

Most used symbols

Sets

Symbol	Description	Example
B	= in plastic wallet	42NEW/B9
BV	= empty wallet	42NEW/BV9
C	= in case	900/C11
D	= in hanging pack	1293/D6
S	= in box	42NEW/S17
SP	= with display	42NEW/SP25
SPV	= empty display	42NEW/SPV7
SC	= with compact support	96/SC9
SCV	= compact support, empty	96/SCV

Assortments

Symbol	Description	Example
AS	= with tools in inches	5915VU/AS
E	= Electronics/Electrotechnics	5980ET/A
I	= Plumbing	5980ID
MT	= Earth-moving	5902MT
U	= Universal	5915VU/3
SBK	= Motorcycle Repairs	5940SBK
VG	= Automotive	5904VG/5T
VI	= Industry	5902VI

Sockets

Symbol	Description	Example
A	= hexagon profile	910A
B	= bi-hex profile	910B
ES	= grooved profile	920ES
FTX	= for TORX® screws	910FTX

Example

Most used symbols

PT	= for 5-star head screws	910PT
X	= reversible ratchet in cases	920A/C12X

Screwdrivers and bits

LP	= for slotted head screws	920LP
PE	= for hexagon screws	920PE
PH	= for cross head PHILLIPS® screws	920PH
PZ	= for cross head POZIDRIV® - SUPADRIV® screws	1299PZ
RTX	= for TAMPER RESISTANT TORX® screws	1298RTX
SP	= for SPANNER screws	861SP
TRW	= for TRI-WING® screws	861TRW
TQS	= for TORQ-SET® screws	861TQS
TX	= for TORX® head screws	920TX
XZN	= for XZN® screws	920XZN

Miscellaneous

AS	= sizes in inches	42AS
BA	= spark-proof tools	42BA
BM	= bi-material handle	1150BM
C	= empty metal container	C25
HS	= tethered tools	42HS
INOX	= tools made of stainless steel	42 INOX
L	= long series	952L
MQ	= 1000V insulated tools	1150MQ
MP	= bright finish	42MP
R	= spare part	338R

The pictures are given by way of example.

Beta Utensili reserve the right to update and enhance their product range without notice.



Beta RECOMMENDS using the tools correctly and complying with personal protection standards.



30 drift punches



Ø mm	L mm		
2	125	10	000300020
3	125	10	000300030
4	150	10	000300040
5	150	10	000300050
6	150	10	000300060

31 pin punches



Ø mm	L mm	L1 mm		
2	110	22	10	000310002
3	128	35	10	000310003
4	146	45	10	000310004
5	164	55	10	000310005
6	182	65	5	000310006
8	200	80	5	000310008
10	220	95	5	000310010



31/B6



31/SP6

31/B6	2-3-4-5-6-8 mm	1	000310020
42/BV6		1	000420051
31/SP6	2-3-4-5-6-8 mm	1	000310030
31/SPV		1	000310031

31BM pin punches with handles



Ø mm	L mm	L1 mm		
2	168	42	2	000310402
3	180	52	2	000310403
4	191	62	2	000310404
5	200	72	2	000310405
6	221	82	2	000310406
8	235	94	2	000310408



31BM/D6	2-3-4-5-6-8 mm	1	000310420
---------	----------------	---	-----------

31L pin punches, long series



Ø mm	L mm	L1 mm		
4	175	80	5	000310104
5	175	80	5	000310105
6	175	80	5	000310106

31SE punches for spring pins



Ø mm	D mm	L mm	L1 mm		
4	2,4	175	80	5	000310204
5	3,0	175	80	5	000310205
6	3,6	175	80	5	000310206



31/B6-LSE		1	000310320
31L: 4-5-6 mm			
31SE: 4-5-6 mm			
55/BV6		1	000550151

32 centre punches



Ø mm	L mm	L1 mm		
3	100	44	10	000320100
4	125	52	10	000320125
5	150	62	10	000320150

32AU automatic centre punches

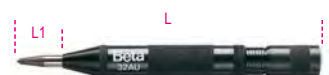

Ø mm	L mm	L1 mm		
3	150	23	2	000320160

32AUR spare tip for automatic centre punch



Ø mm			
3		5	000320170

34 flat chisels



L mm	A mm	L1 mm		
125	14,5	45	5	000340001
150	17,0	58	5	000340002
175	21,5	68	5	000340003

35 flat chisels, ribbed type



L mm	A mm		
100	14,5	5	000350001
125	17,0	5	000350002
150	20,5	5	000350003
200	23,0	5	000350004
250	28,5	2	000350005
300	34,0	2	000350006

35PM flat chisels, ribbed type with hand guards



L mm	A mm		
200	23,0	2	000350014
250	28,5	2	000350015
300	34,0	2	000350016

35PMR spare hand guards



L mm			
200		1	000350024
250		1	000350025
300		1	000350026

36

cape chisels



L mm	A mm	L1 mm	
125	4	44	5 000360001
150	6	53	5 000360002

37

cape chisels, ribbed type



L mm	A mm	L1 mm	
150	6	45	5 000370001
200	8	55	3 000370002

37PM

cape chisel, ribbed type with hand guard



L mm	A mm	
200	8	2 000370012

37PMR

spare hand guard



L mm	
200	1 000370022



38/B6	1 000380006
30: 2-3 mm	
32: 4 mm	
34: 125-150 mm	
36: 150 mm	
42/BV6	1 000420051
38/SP6	1 000380009
30: 2-3 mm	
32: 4 mm	
34: 125-150 mm	
36: 150 mm	
38/SPV	1 000380019

42NEW

combination wrenches



DIN 3113 UNI-ISO 7738

mm	L mm	S1 mm	
5,5	95	3,4	5 000421005
6	95	3,4	5 000421006
7	105	3,6	5 000421007
8	116	3,9	5 000421008
9	127	4,2	5 000421009
10	137	4,5	5 000421010
11	148	4,8	5 000421011
12	158	5,1	5 000421012
13	169	5,6	5 000421013
14	180	5,7	5 000421014
15	190	6,0	5 000421015
16	201	6,3	5 000421016
17	212	6,8	5 000421017
18	222	7,0	5 000421018
19	233	7,5	5 000421019
20	243	7,7	3 000421020
21	254	7,9	3 000421021
22	264	8,3	3 000421022
23	275	8,5	3 000421023
24	285	8,7	3 000421024
25	296	8,7	2 000421025
26	307	8,9	2 000421026
27	317	9,1	2 000421027
28	328	9,3	2 000421028
29	338	9,5	2 000421029
30	349	9,7	2 000421030
32	370	10,1	2 000421032
34	391	10,5	1 000421034
35	412	10,7	1 000421035
36	412	10,7	1 000421036
38	433	11,3	1 000421038
41	465	12,0	1 000421041



42NEW/B9	1 000421064
6-7-8-10-11-13-14-17-19 mm	
42/BV9	1 000420056



42NEW/S14	1 000421067
6-7-8-10-11-12-13-14	
-15-16-17-19-22-24 mm	
42NEW/S17	1 000421065
6-7-8-9-10-11-12-13-14-15	
16-17-18-19-20-21-22 mm	
42NEW/S15	1 000421066
6-7-8-10-11-12-13-14	
17-19-22-24-27-30-32 mm	
42NEW/S17X	1 000421068
6-7-8-10-11-12-13-14-	
15-16-17-19-21-22-	
24-27-30 mm	
42NEW/S26	1 000421070
6-7-8-9-10-11-12-13-14	
15-16-17-18-19-20-21	
22-23-24-25-26-27-28	
29-30-32 mm	

set of 9 combination wrenches with compact support



42NEW/SC9I	1 000421087
8-10-11-12-13-14-15-17-19 mm	
42/SCV9I	1 000420103
42NEW/SC9E	1 000421088
8-10-11-12-13-16-17-18-19 mm	
42/SCV9E	1 000420104



42NEW/SP25	1 000421085
6-7-8-9-10-11-12-13-14	
15-16-17-18-19-20-21	
22-23-24-25-26-27-28	
30-32 mm	
42/SPV2	1 000420090

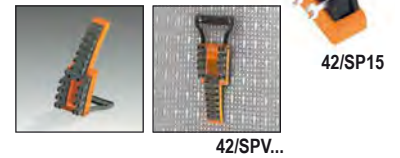

42NEW/SP15	1 000421078
6-7-8-9-10-11-12-13-14-15	
16-17-19-22-24 mm	
42/SPV7	1 000420097
42: 8-10-11-13-14-17-19 mm	
55: 6x7-8x9-10x11-12x13	
14x15-16x17-18x19 mm	
42/SPV11	1 000420100
42MP: 8-9-10-11-12-13	
14-15-16-17-19 mm	
142-142SN: 8-9-10-11-12-13	
14-15-16-17-19 mm	
42/SPV15	1 000420102
42: 6-7-8-9-10-11-12-13-14	
15-16-17-19-22-24 mm	

42

combination wrenches,
open and offset ring ends

**SUBJECT TO
AVAILABILITY**



DIN 3113 UNI-ISO 7738

mm	L mm	S1 mm		
5,5x5,5	95	3,4	5	000420005
6x6	95	3,4	5	000420006
7x7	105	3,6	5	000420007
8x8	116	3,9	5	000420008
9x9	127	4,2	5	000420009
10x10	137	4,5	5	000420010
11x11	148	4,8	5	000420011
12x12	158	5,1	5	000420012
13x13	169	5,4	5	000420013
14x14	180	5,7	5	000420014
15x15	190	6,0	5	000420015
16x16	201	6,3	5	000420016
17x17	212	6,7	5	000420017
18x18	222	7,0	5	000420018
19x19	233	7,3	5	000420019
20x20	243	7,6	3	000420020
21x21	254	7,9	3	000420021
22x22	264	8,1	3	000420022
23x23	275	8,3	3	000420023
24x24	285	8,5	3	000420024
25x25	296	8,7	2	000420025
26x26	307	8,9	2	000420026
27x27	317	9,1	2	000420027
28x28	328	9,3	2	000420028
29x29	338	9,5	2	000420029
30x30	349	9,7	2	000420030
32x32	370	10,1	2	000420032
34x34	391	10,5	1	000420034
35x35	412	10,7	1	000420035
36x36	412	10,9	1	000420036
38x38	433	11,3	1	000420038
41x41	465	12,0	1	000420041

42AS

combination wrenches,
open and offset ring ends



mm	L mm		
1/4x1/4	95	2	000420106
9/32x9/32	106	2	000420107
5/16x5/16	116	2	000420108
3/8x3/8	137	2	000420110
7/16x7/16	148	2	000420111
1/2x1/2	169	2	000420113
9/16x9/16	180	2	000420114
19/32x19/32	191	2	000420115
5/8x5/8	201	2	000420116
11/16x11/16	212	2	000420117
3/4x3/4	233	2	000420119
13/16x13/16	254	2	000420121
7/8x7/8	264	2	000420122
15/16x15/16	285	2	000420124
1x1	296	2	000420125
1.1/16x1.1/16	317	2	000420127
1.1/8x1.1/8	338	2	000420129
1.1/4x1.1/4	370	2	000420132
1.5/16x1.5/16	391	1	000420133
1.3/8x1.3/8	412	1	000420135
1.7/16x1.7/16	412	1	000420136
1.1/2x1.1/2	433	1	000420138



42AS/B9	1	000420155
1/4-5/16-3/8-7/16-1/2		
9/16-5/8-11/16-3/4		



42AS/13	1	000420163
1/4-5/16-3/8-7/16-1/2-9/16-5/8		
11/16-3/4-13/16-7/8-15/16-1		
42AS/16	1	000420166
1/4-5/16-3/8-7/16-1/2-9/16-5/8		
11/16-3/4-13/16-7/8-15/16-1-1.1/16-1.1/8-1.1/4		
42AS/17	1	000420168
1/4-9/32-5/16-3/8-7/16-1/2-		
9/16-19/32-5/8-11/16-3/4-		
13/16-7/8-15/16-1-1.1/16-1.1/8		

42MP

combination wrenches, open and offset
ring ends, bright chrome-plated



DIN 3113 UNI-ISO 7738

mm	L mm		
6x6	95	5	000420606
7x7	105	5	000420607
8x8	116	5	000420608
9x9	127	5	000420609
10x10	137	5	000420610
11x11	148	5	000420611
12x12	158	5	000420612
13x13	169	5	000420613
14x14	180	5	000420614
15x15	190	5	000420615
16x16	201	5	000420616
17x17	212	5	000420617
18x18	222	5	000420618
19x19	233	5	000420619
20x20	243	3	000420620
21x21	254	3	000420621
22x22	264	3	000420622
24x24	285	3	000420624
27x27	317	3	000420627
30x30	349	3	000420630
32x32	370	3	000420632



42MP/B9	1	000420651
6-7-8-10-11-13-14-17-19 mm		
42/BV9	1	000420056



42MP/S17	1	000420652
6-7-8-9-10-11-12-13-14-15		
16-17-18-19-20-21-22 mm		
42MP/S21	1	000420653
6-7-8-9-10-11-12-13-14		
15-16-17-18-19-20-21-22		
24-27-30-32 mm		

42LMP

combination wrenches, open and offset
ring ends, long series, bright chrome-plated



mm	L mm		
8x8	148	2	000420508
9x9	167	2	000420509
10x10	172	2	000420510
11x11	186	2	000420511
12x12	197	2	000420512
13x13	207	2	000420513
14x14	223	2	000420514
15x15	233	2	000420515
16x16	243	2	000420516
17x17	261	2	000420517
18x18	270	2	000420518
19x19	280	2	000420519
21x21	301	2	000420521
22x22	318	2	000420522
24x24	338	2	000420524
27x27	376	2	000420527
30x30	394	2	000420530
32x32	435	2	000420532



42LMP/S14	1	000420551
8-9-10-11-12-13-14		
15-16-17-18-19-21-22 mm		
42LMP/S18	1	000420552
8-9-10-11-12-13-14		
15-16-17-18-19-21-22		
24-27-30-32 mm		



42SLIM

combination wrenches with thin open ends



DIN 3113 UNI-ISO 7738

mm	L mm	S1 mm		
8x8	116	3,4	5	000420408
10x10	137	3,8	5	000420410
11x11	148	3,8	5	000420411
12x12	158	4,2	5	000420412
13x13	169	4,4	5	000420413
14x14	180	4,6	5	000420414
15x15	190	4,7	5	000420415
16x16	201	4,7	5	000420416
17x17	212	5,1	5	000420417
18x18	222	5,1	5	000420418
19x19	233	5,6	5	000420419



42SLIM/B8I	10-11-12-13-14-15-17-19 mm	1	000420468
42SLIM/B8E	10-11-12-13-16-17-18-19 mm	1	000420469
42SLIM/S11	8-10-11-12-13-14-15-16-17-18-19 mm	1	000420471

45

combination wrenches, open and offset ring ends, heavy series



DIN 3113 UNI-ISO 7738

mm	L mm		
46x46	500	1	000450046
50x50	540	1	000450050
55x55	560	1	000450055
60x60	600	1	000450060
65x65	675	1	000450065
70x70	675	1	000450070
75x75	720	1	000450075
80x80	720	1	000450080

52

single open end wrenches



UNI 6733 DIN 3114

mm	L mm		
10	119	5	000520010
11	119	5	000520011
12	119	5	000520012
13	145	5	000520013
14	145	5	000520014
15	145	5	000520015
16	159	5	000520016
17	159	5	000520017
18	159	5	000520018
19	175	5	000520019
20	175	5	000520020
21	175	5	000520021
22	196	2	000520022
23	196	2	000520023
24	196	2	000520024
25	215	2	000520025
26	215	2	000520026
27	215	2	000520027
28	240	2	000520028
30	240	2	000520030
32	270	2	000520032
34	270	1	000520034
35	295	1	000520035
36	295	1	000520036
38	295	1	000520038
40	335	1	000520040
41	335	1	000520041
42	335	1	000520042
45	370	1	000520045
46	370	1	000520046
48	370	1	000520048
50	415	1	000520050
52	415	1	000520052
55	415	1	000520055
60	490	1	000520060
65	490	1	000520065
70	490	1	000520070

53

single open end wrenches DIN 894



mm	L mm		
36	317	1	000530036
38	320	1	000530038
41	342	1	000530041
46	396	1	000530046
50	412	1	000530050
55	457	1	000530055
60	492	1	000530060
65	528	1	000530065
70	572	1	000530070
75	608	1	000530075
80	645	1	000530080
85	690	1	000530085
90	690	1	000530090
95	847	1	000530095
100	847	1	000530100
105	1000	1	000530105
110	1000	1	000530110
115	1000	1	000530115
120	1000	1	000530120
125	1000	1	000530125
130	1000	1	000530130
135	1000	1	000530135

55

double open end wrenches



UNI-ISO 10102 DIN 3110

mm	L mm		
4x5	101	5	000550003
5x5,5	101	5	000550006
5,5x7	120	5	000550009
6x7	120	5	000550012
7x8	140	5	000550018
8x9	140	5	000550021
8x10	140	5	000550024
10x11	155	5	000550030
10x12	155	5	000550033
10x13	170	5	000550035
12x13	170	5	000550042
12x14	170	5	000550045
13x14	185	5	000550047
13x17	189	5	000550051
14x15	185	5	000550054
14x17	189	5	000550057
16x17	202	5	000550060
17x19	220	2	000550063
18x19	220	2	000550066
19x22	236	2	000550069
20x22	236	2	000550075
21x23	245	2	000550078
22x24	245	2	000550081
24x26	262	2	000550087
24x27	262	2	000550090
25x28	272	2	000550096
27x29	284	2	000550099
27x30	284	2	000550102
27x32	297	2	000550105
30x32	297	2	000550108
32x36	325	1	000550114
34x36	325	1	000550117
35x38	375	1	000550120
36x41	375	1	000550123
41x46	425	1	000550129
46x50	475	1	000550132
50x55	500	1	000550135
55x60	500	1	000550138



55/B8	6x7-8x9-10x11-12x13-14x15-16x17-18x19-20x22 mm	1	000550158
55/BV8		1	000550159
55/B12	6x7-8x9-10x11-12x13-14x15-16x17-18x19-20x22-21x23-24x26-25x28-30x32 mm	1	000550162
55/BV12		1	000550163

Beta

Beta



55/S8 6x7-8x9-10x11-12x13 14x15-16x17-18x19 20x22 mm	1	000550174
55/S12 6x7-8x9-10x11-12x13 14x15-16x17-18x19 20x22-21x23-24x26 25x28-30x32 mm	1	000550178
55/S12X 6x7-8x9-10x11-12x13 14x15-16x17-18x19 20x22-21x23-24x27 25x28-30x32 mm	1	000550179
55/S13 6x7-8x9-10x11-12x13 14x15-16x17-18x19 20x22-21x23-24x26 25x28-27x29-30x32 mm	1	000550182



55AS/5 5/16x11/32-3/8x7/16 1/2x9/16-5/8x11/16 3/4x7/8	1	000550290
55AS/8 1/4x9/32-5/16x11/32-3/8x7/16- 1/2x9/16-9/16x5/8-5/8x11/16- 11/16x13/16-3/4x7/8	1	000550296
55AS/12 1/4x9/32-5/16x11/32-3/8x7/16-1 /2x9/16-9/16x5/8-5/8x11/16- 11/16x13/16-25/32x13/16-3/4x7/8- 15/16x1-1x1.1/8-1.1/16x1.1/4	1	000550298

55MP

double open end wrenches,
bright chrome-plated



UNI-ISO 10102 DIN 3110

mm	L mm		
6x7	120	2	000550603
8x9	140	2	000550606
10x11	155	2	000550609
12x13	170	2	000550612
14x15	185	2	000550615
16x17	202	2	000550618
18x19	220	2	000550621
20x22	236	2	000550624
21x23	245	2	000550627
24x26	262	1	000550630
25x28	272	1	000550633
27x29	284	1	000550636
30x32	297	1	000550639



55MP/S8 6x7-8x9-10x11-12x13 14x15-16x17-18x19 20x22 mm	1	000550650
55MP/S13 6x7-8x9-10x11-12x13 14x15-16x17-18x19 20x22-21x23-24x26 25x28-27x29-30x32 mm	1	000550651
55MP/S12 6x7-8x9-10x11-12x13-14x15- 16x17-18x19-20x22-21x23-24x26- 25x28-30x32 mm	1	000550653



58

open end slogging wrenches



DIN 133

mm	L mm		
24	177	1	000580024
27	180	1	000580027
30	190	1	000580030
32	190	1	000580032
34	200	1	000580034
36	215	1	000580036
41	235	1	000580041
46	255	1	000580046
50	275	1	000580050
55	300	1	000580055
60	320	1	000580060
65	342	1	000580065
70	375	1	000580070
75	375	1	000580075
80	408	1	000580080
85	408	1	000580085
90	445	1	000580090
95	445	1	000580095
100	485	1	000580100
105	485	1	000580105
110	510	1	000580110
115	510	1	000580115
120	545	1	000580120
125	545	1	000580125
130	575	1	000580130
135	575	1	000580135
*140	575	1	000580140
*145	640	1	000580145
*150	640	1	000580150
*155	640	1	000580155
*160	640	1	000580160
*165	715	1	000580165
*170	715	1	000580170
*175	715	1	000580175
*180	715	1	000580180
*185	715	1	000580185
*190	800	1	000580190
*195	800	1	000580195
*200	800	1	000580200
*210	800	1	000580210
*220	800	1	000580220
*230	800	1	000580230

55AS

double open end wrenches



mm	L mm		
1/4x9/32	120	2	000550203
1/4x5/16	120	2	000550206
5/16x11/32	140	2	000550209
5/16x3/8	140	2	000550212
3/8x7/16	155	2	000550215
7/16x1/2	170	2	000550218
1/2x9/16	170	2	000550221
9/16x5/8	185	2	000550224
19/32x11/16	189	2	000550227
5/8x11/16	202	2	000550230
5/8x3/4	202	2	000550233
11/16x13/16	220	2	000550242
3/4x7/8	236	2	000550245
25/32x13/16	236	2	000550244
7/8x15/16	245	2	000550251
15/16x1	262	1	000550257
1x1.1/8	272	1	000550259
1.1/16x1.1/4	284	1	000550267
1.1/8x1.5/16	297	1	000550266
1.5/16x1.1/2	325	1	000550269
1.3/8x1.1/2	375	1	000550272
1.7/16x1.5/8	375	1	000550275

73

small double open end wrenches



UNI 6737

mm	L mm		
4x4	78	5	000730040
4,5x4,5	78	5	000730045
5x5	78	5	000730050
5,5x5,5	86	5	000730055
6x6	86	5	000730060
7x7	86	5	000730070
8x8	97	5	000730080
9x9	97	5	000730090
10x10	108	5	000730100
11x11	108	5	000730110
12x12	124	5	000730120
13x13	124	5	000730130
14x14	124	5	000730140



73/B13	1 000730200
4-4,5-5-5,5-6-7-8-9	
10-11-12-13-14 mm	
73/BV	1 000730201



73/S13	1 000730210
4-4,5-5-5,5-6-7-8-9	
10-11-12-13-14 mm	

78 ring slogging wrenches



DIN 7444

mm	L mm	
24	162	1 000780024
27	180	1 000780027
30	190	1 000780030
32	190	1 000780032
34	200	1 000780034
36	205	1 000780036
41	225	1 000780041
46	235	1 000780046
50	250	1 000780050
55	265	1 000780055
60	275	1 000780060
65	295	1 000780065
70	325	1 000780070
75	325	1 000780075
80	350	1 000780080
85	350	1 000780085
90	390	1 000780090
95	390	1 000780095
100	420	1 000780100
105	420	1 000780105
110	450	1 000780110
115	450	1 000780115
120	490	1 000780120
125	480	1 000780125
130	520	1 000780130
135	520	1 000780135
*140	520	1 000780140
*145	580	1 000780145
*150	580	1 000780150
*155	580	1 000780155
*160	650	1 000780160
*165	650	1 000780165
*170	650	1 000780170
*175	650	1 000780175
*180	650	1 000780180
*185	695	1 000780185
*190	695	1 000780190
*195	695	1 000780195
*200	695	1 000780200
*210	740	1 000780210
*215	740	1 000780215
*220	740	1 000780220
*230	740	1 000780230

78AS ring slogging wrenches



"	L mm	
*1.1/16	180	1 000780327
*1.1/8	190	1 000780329
*1.3/16	190	1 000780330
*1.1/4	197	1 000780332
*1.5/16	197	1 000780333
*1.3/8	223	1 000780335
*1.7/16	223	1 000780336
*1.1/2	223	1 000780338
*1.5/8	223	1 000780341
*1.11/16	225	1 000780343
*1.13/16	240	1 000780346
*1.7/8	250	1 000780348
*2	250	1 000780350
*2.1/16	250	1 000780352
*2.3/16	275	1 000780355
*2.3/8	270	1 000780360
*2.9/16	302	1 000780365
*2.3/4	350	1 000780370
*2.15/16	350	1 000780375
*3.1/8	354	1 000780380

80 double swivel end socket wrenches



mm	L mm	
6x7	170	3 000800006
8x9	176	3 000800008
8x10	179	3 000800009
10x11	182	3 000800010
12x13	228	3 000800012
14x15	232	3 000800014
13x17	231	3 000800015
16x17	234	2 000800016
18x19	285	2 000800018
19x22	287	2 000800019
20x22	289	2 000800020
21x23	289	2 000800021
24x27	405	2 000800024
30x32	413	2 000800030



80/S8	1 000800051
6x7-8x9-10x11-12x13-14x15	
16x17-18x19-20x22 mm	
80/S11	1 000800056
6x7-8x9-10x11-12x13	
14x15-16x17-18x19-20x22	
21x23-24x27-30x32 mm	

83 half-moon ring wrenches



ISO 3318

mm	L mm	
8x10	126	3 000830008
10x12	137	3 000830010
11x13	138	3 000830011
14x17	183	3 000830014
15x17	184	2 000830015
16x18	196	2 000830016
19x22	231	2 000830019



83/S3	1 000830081
11x13-14x17-19x22 mm	
83/S5	1 000830085
10x12-11x13-15x17	
16x18-19x22 mm	

83AS half-moon ring wrenches



"	L mm	
7/16x1/2	138	2 000830111
9/16x5/8	183	2 000830114
3/4x7/8	230	2 000830119



83AS/3	1 000830181
7/16x1/2-9/16x5/8	
3/4x7/8	

88 double ended flat ring wrenches, extra-long series



mm	L mm	
8x10	235	2 000880008
12x14	330	2 000880012
13x15	330	2 000880013
16x18	405	2 000880016
17x19	405	2 000880017
21x23	435	2 000880021
22x24	435	2 000880022



88/S7
8x10-12x14-13x15-16x18-
17x19-21x23-22x24 mm

1 000880107

90

double ended deep offset ring wrenches



DIN 838 ISO 10104

Ø mm	L mm		
6x7	165	5	000900006
8x9	180	5	000900012
8x10	180	5	000900015
10x11	195	5	000900018
10x12	195	5	000900021
11x13	215	5	000900024
12x13	215	5	000900027
12x14	215	5	000900030
14x15	230	5	000900033
14x17	250	5	000900036
16x17	250	5	000900039
17x19	265	5	000900042
18x19	265	5	000900045
19x22	285	3	000900048
20x22	285	3	000900051
21x23	305	2	000900057
22x24	305	2	000900060
24x26	325	2	000900063
24x27	325	2	000900067
25x28	340	2	000900070
27x29	355	2	000900073
27x30	355	2	000900076
27x32	375	2	000900078
30x32	375	2	000900080
32x36	395	1	000900088
34x36	415	1	000900089
35x38	415	1	000900091
36x41	435	1	000900094
41x46	460	1	000900097
46x50	500	1	000900100



90/B8
6x7-8x9-10x11-12x13
14x15-16x17-18x19
20x22 mm

1 000900154

90/BV8 1 000900155



90/S8
6x7-8x9-10x11-12x13
14x15-16x17-18x19
20x22 mm

1 000900162

90/S12
6x7-8x9-10x11-12x13
14x15-16x17-18x19
20x22-21x23-24x26
25x28-30x32 mm

1 000900166

90/S12X
6x7-8x9-10x11-12x13
14x15-16x17-18x19
20x22-21x23-24x27
25x28-30x32 mm

1 000900167

90/S13
6x7-8x9-10x11-12x13
14x15-16x17-18x19
20x22-21x23-24x26
25x28-27x29-30x32 mm

1 000900170



90/SP13
6x7-8x9-10x11-12x13
14x15-16x17-18x19
20x22-21x23-24x26
25x28-27x29-30x32 mm

1 000900174

55/SPV 1 000550190



90AS

double ended deep offset ring wrenches



Ø mm	L mm		
1/4x5/16	165	2	000900203
5/16x11/32	180	2	000900206
5/16x3/8	180	2	000900209
3/8x7/16	195	2	000900212
7/16x1/2	215	2	000900215
1/2x9/16	230	2	000900218
9/16x5/8	230	2	000900221
19/32x11/16	250	2	000900222
5/8x11/16	250	2	000900224
5/8x3/4	265	2	000900227
11/16x3/4	265	1	000900230
11/16x13/16	265	1	000900233
3/4x25/32	265	1	000900235
3/4x7/8	285	1	000900237
13/16x7/8	285	1	000900240
7/8x15/16	305	1	000900243
15/16x1	325	1	000900252
1.1/16x1.1/4	375	1	000900258
1.1/8x1.5/16	375	1	000900261



90AS/8
1/4x5/16-5/16x11/32
3/8x7/16-1/2x9/16
5/8x11/16-11/16x3/4
13/16x7/8-15/16x1

1 000900298

90AS/10
1/4x5/16-5/16x11/32
3/8x7/16-1/2x9/16
5/8x11/16-11/16x3/4
13/16x7/8-15/16x1
1.1/16x1.1/4-1.1/8x1.5/16

1 000900300

91

heavy duty offset ring wrenches



Ø mm	Ø mm		
24	38	1	000910024
27	41	1	000910027
30	48	1	000910030
32	49	1	000910032
36	54	1	000910036
41	62	1	000910041
46	69	1	000910046
50	76	1	000910050
55	81	1	000910055
60	90	1	000910060
65	98	1	000910065
70	105	1	000910070
75	110	1	000910075
80	125	1	000910080
85	125	1	000910085
90	140	1	000910090
95	140	1	000910095
100	143	1	000910100
105	146	1	000910105

92

tubes for item 91



L mm	91 mm	Ø mm		
92/1	460	24÷30	19	1 000920010
92/2	610	32÷41	22	1 000920020
92/3	760	46÷55	25	1 000920030
92/4	860	60÷105	30	1 000920040

93

double-ended offset ring wrench for scaffolding bolts



Ø mm	L mm		
21x22	310	3	000930021

93C

ratcheting double-ended offset ring wrenches for scaffolding bolts



mm	L mm		
17x19	310	1	000930117
19x22	310	1	000930119
19x24	310	1	000930120
21x22	365	1	000930121
36x38	445	1	000930136

94

flare nut open ring wrenches



DIN 3118

mm	L mm		
8x10	140	2	000940008
9x11	153	2	000940009
10x11	153	2	000940010
11x13	175	2	000940011
12x14	175	2	000940012
13x15	175	2	000940013
14x15	175	2	000940014
14x17	195	2	000940015
17x19	212	2	000940017
19x22	228	2	000940019
22x24	242	2	000940022
24x27	260	2	000940024
30x32	300	2	000940030
36x41	320	1	000940036



94/S6 1 000940050

8x10-10x11-11x13-12x14
17x19-19x22 mm

94/S10 1 000940052

8x10-9x11-10x11-11x13
12x14-17x19-19x22
22x24-24x27-30x32 mm

95

double ended flat ring wrenches



DIN 837 ISO 10103

mm	L mm		
6x7	120	3	000950161
8x9	135	3	000950162
10x11	150	3	000950163
12x13	165	3	000950164
14x15	185	3	000950165
16x17	210	3	000950166
17x19	225	3	000950167
18x19	225	2	000950168
20x22	240	2	000950169
21x23	255	2	000950170
24x26	270	2	000950171
25x28	285	2	000950172
27x29	315	2	000950173
30x32	335	2	000950174



95/S8 1 000950177

6x7-8x9-10x11-12x13
14x15-16x17-18x19
20x22 mm

95/S13 1 000950179

6x7-8x9-10x11-12x13
14x15-16x17-18x19
20x22-21x23-24x26
25x28-27x29-30x32 mm

95FTX

double-ended straight wrenches, for Torx® head screws



	L mm		
E6xE8	115	2	000950306
E10xE12	143	2	000950310
E14xE18	177	2	000950314
E20xE24	224	2	000950320



95FTX/S4 1 000950325

E6xE8-E10xE12
E14xE18-E20xE24

96

offset hexagon key wrenches chrome-plated



ISO 2936

mm	L mm	L1 mm		
0,9	35	8	20	000960013
1,3	39	10	20	000960014
1,5	45	15	20	000960015
2	50	17	20	000960020
2,5	57	20	20	000960025
3	64	22	20	000960030
3,5	68	25	20	000960035
4	72	28	20	000960040
4,5	78	30	20	000960045
5	83	32	20	000960050
5,5	88	35	20	000960055
6	94	37	20	000960060
7	99	40	10	000960070
8	105	43	10	000960080
9	111	46	10	000960090
10	119	49	10	000960100
11	126	52	10	000960110
12	134	56	10	000960120
13	142	62	10	000960130
14	151	69	10	000960140
16	165	75	5	000960160
17	174	79	5	000960170
19	196	88	5	000960190

mm	L mm	L1 mm		
22	216	100	3	000960220
24	242	112	1	000960240
27	271	125	1	000960270
30	309	140	1	000960300
32	341	155	1	000960312
36	385	174	1	000960316



96/ST6 3 000960370

2,5-3-4-5-6-8 mm



96/BGS7 1 000960367

1,5-2-2,5-3-4-5-6 mm



96/BG7 1 000960368

2,5-3-4-5-6-8-10 mm



96/B8 5 000960386

2-2,5-3-4-5-6-8-10 mm

96/B10 5 000960380

1,5-2-2,5-3-4-5-6-8-10-12 mm

96N/BV 1 000960651



96/SC9 1 000960374

1,5-2-2,5-3-4-5-6-8-10 mm

96/SCV 1 000960985

Beta
Quality Tools



96/SC12
2-2,5-3-3,5-4-4,5-5
6-7-8-9-10 mm

1 000960395

96/SCV12
1 000960975

96N
offset hexagon key wrenches,
burnished



ISO 2936

mm	L mm	L1 mm		
0,9	32	10	20	000960409
1,3	44	12	20	000960413
1,5	46	15	20	000960415
2	51	17	20	000960420
2,5	57	20	20	000960425
3	64	22	20	000960430
3,5	68	25	20	000960435
4	72	28	20	000960440
4,5	78	30	20	000960445
5	83	32	20	000960450
6	94	37	20	000960460
7	99	40	10	000960470
8	105	43	10	000960480
9	111	46	10	000960490
10	119	49	10	000960500
11	126	52	10	000960510
12	134	56	10	000960520
13	142	62	10	000960530
14	151	69	10	000960540
16	165	72	5	000960560
17	174	79	5	000960570
19	194	88	5	000960590
22	216	99	1	000960592
24	242	111	1	000960594



96N/ST6
2,5-3-4-5-6-8 mm

3 000960640



96N/G7
2,5-3-4-5-6-8-10 mm

96N/G7A
1,5-2-2,5-3-4-5-6 mm

3 000960645

3 000960643



96N/B10
1,5-2-2,5-3-4-5-6
8-10-12 mm

96N/BV
1 000960651

5 000960650



96N/SC9
1,5-2-2,5-3-4-5-6-8-10 mm

96N/SCV
1 000960986

1 000960644



96N/SC12
2-2,5-3-3,5-4-4,5-5
6-7-8-9-10 mm

96N/SCV12
1 000960976

1 000960661

96C/AS
offset hexagon key wrenches,
chrome-plated



"	L mm	L1 mm	g		
1/16	46	16	1,01	20	000961702
3/32	53	19	2,70	20	000961706
1/8	60	22	5,33	20	000961710
5/32	67	25	9,33	20	000961714
3/16	74	28	14,87	20	000961716
7/32	81	32	22,00	20	000961718
1/4	89	35	31,40	20	000961720
5/16	103	40	56,16	10	000961724
3/8	117	45	91,31	10	000961728



96C-AS/SC9
1/16-3/32-1/8-5/32-3/16-
7/32-1/4-5/16-3/8

1 000961753

96AS
offset hexagon key wrenches,
burnished



"	L mm	L1 mm		
1/30 (0,035")	44	14	20	000960698
1/20 (0,050")	44	15	20	000960701
1/16	46	16	20	000960702
5/64	50	18	20	000960704
3/32	53	19	20	000960706
7/64	57	21	20	000960708
1/8	60	22	20	000960710
9/64	64	24	20	000960712
5/32	68	25	20	000960714
3/16	75	29	20	000960716
7/32	82	32	20	000960718
1/4	89	35	20	000960720
5/16	103	40	10	000960724
3/8	117	44	10	000960728
7/16	132	49	10	000960730
1/2	149	54	10	000960732
9/16	151	69	2	000960734
5/8	165	72	1	000960736
3/4	194	88	1	000960738



96AS/SC9
1/16-3/32-1/8-5/32-3/16
7/32-1/4-5/16-3/8

96AS/SCV
1 000960744

1 000960743



96AS/T7
3/32-1/8-5/32
3/16-7/32-1/4-5/16

3 000960740



96AS/G7
3/32-1/8-5/32
3/16-1/4-5/16-3/8

3 000960745



96AS/BG7
1/16-3/32-1/8-5/32-3/16
1/4-5/16-3/8

1 000960747



96AS/B11 1 000960749
 1/20-1/16-5/64-3/32
 1/8-5/32-3/16-7/32
 1/4-5/16-3/8
96N/BV 1 000960651

96LC
 offset hexagon key wrenches,
 long series, chrome-plated



ISO 2936

mm	L mm	L1 mm		
2	101	17	20	000960320
2,5	113	20	20	000960321
3	127	22	20	000960322
3,5	138	25	20	000960323
4	142	28	20	000960324
4,5	154	28	20	000960325
5	163	32	20	000960326
6	184	37	20	000960327
7	194	40	10	000960328
8	205	43	10	000960329
9	216	46	10	000960330
10	231	49	10	000960331
12	259	56	10	000960332



96LC/SC8 1 000960334
 2-2,5-3-4-5-6-8-10 mm
96LC/SCV 1 000960983



96LC/SC12 1 000960337
 2-2,5-3-3,5-4-4,5-5-
 6-7-8-9-10 mm
96LC/SCV12 1 000960977



96L
 offset hexagon key wrenches,
 long series, burnished



ISO 2936

mm	L mm	L1 mm		
2	99	15	20	000960820
2,5	110	17	20	000960825
3	124	19	20	000960830
3,5	135	21	20	000960835
4	138	24	20	000960840
4,5	150	25	20	000960845
5	158	27	20	000960850
6	178	31	20	000960860
7	187	33	10	000960870
8	197	35	10	000960880
9	207	37	10	000960890
10	221	39	10	000960900
12	247	44	10	000960920



96L/SC8 1 000960924
 2-2,5-3-4-5-6-8-10 mm
96L/SCV 1 000960987



96L/SC12 1 000960929
 2-2,5-3-3,5-4-4,5-5-
 6-7-8-9-10 mm
96L/SCV12 1 000960978

96BP-CL
 ball head offset hexagon key wrenches,
 chrome-plated,
 coloured



mm	L mm	L1 mm		
1,5	91	16	5	000961600
2	102	17	5	000961601
2,5	113	21	5	000961602
3	128	23	5	000961603
4	143	28	5	000961604
5	163	33	5	000961605
6	185	37	5	000961606
8	206	43	2	000961608
10	231	50	2	000961610



96BP-CL/SC9 1 000961619
 1,5-2-2,5-3-4-5-6-8-10 mm
96BP-CL/SCV 1 000961629

96BPC
 ball head offset hexagon key wrenches
 chrome-plated



mm	L mm	L1 mm		
1,5	79	13	10	000960340
2	84	15	10	000960341
2,5	89	17	10	000960342
3	99	19	10	000960343
4	108	24	10	000960344
5	126	27	10	000960345
6	148	31	10	000960346
7	157	33	5	000960353
8	168	35	5	000960347
10	187	39	5	000960348
12	220	55	5	000960352



96BPC/SC9 1 000960354
 1,5-2-2,5-3-4-5-6-8-10 mm
96BPC/SCV 1 000960984

96BP
 ball head offset hexagon key wrenches
 burnished

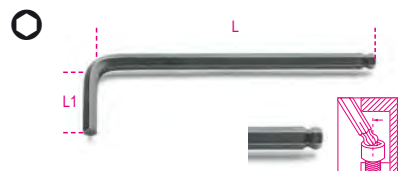

mm	L mm	L1 mm		
1,5	79	13	10	000960960
2	84	15	10	000960961
2,5	89	17	10	000960962
3	99	19	10	000960963
4	108	24	10	000960965
5	126	27	10	000960967
6	148	31	10	000960968
8	168	35	5	000960970
10	187	39	5	000960972
12	220	55	5	000960973



96BP/SC9	1	000960974
1,5-2-2,5-3-4-5-6-8-10 mm		
96BP/SCV	1	000960988

96LBP

ball head offset hexagon key wrenches, extra-long model



mm	L mm	L1 mm		
1,5	90	15	5	000961340
2	100	17	5	000961341
2,5	112	20	5	000961342
3	127	22	5	000961343
4	144	27	5	000961344
5	163	32	5	000961345
6	184	37	5	000961346
8	204	44	2	000961348
10	230	49	2	000961350



96LBP/SC9	1	000961354
1,5-2-2,5-3-4-5-6-8-10 mm		
96LBP/SCV	1	000961984

96BP/AS

ball head offset hexagon wrenches, burnished



"	L mm	L1 mm		
3/32	89	17	10	000960989
1/8	98	18	10	000960990
5/32	108	24	10	000960991
3/16	126	26	10	000960992
7/32	139	28	10	000960993
1/4	152	31	10	000960994
5/16	168	34	5	000960995
3/8	190	39	5	000960996



96BP-AS/SC9	1	000961000
1/16-3/32-1/8-5/32-3/16		
7/32-1/4-5/16-3/8		
96BP-AS/SCV	1	000961001



96BP-AS/8	1	000960997
3/32-1/8-5/32-3/16-7/32		
1/4-5/16-3/8		
96BP-AS/BV	1	000960998

96BPA

ball head offset hexagon key wrenches, 110°, extra-short side model



mm	L mm	L1 mm		
1,5	71	9	5	000961960
2	86	11	5	000961961
2,5	96	13	5	000961962
3	104	15	5	000961963
4	116	17	5	000961964
5	132	19	5	000961965
6	155	21	5	000961966
8	176	24	2	000961968
10	200	27	2	000961970



96BPA/SC9	1	000961974
1,5-2-2,5-3-4-5-6-8-10 mm		
96BPA/SCV	1	000961988



96T

offset hexagon key wrenches, with high torque handles



mm	L mm	L1 mm		
2	139	52	5	000960934
2,5	153	55	5	000960935
3	153	55	5	000960936
3,5	179	70	5	000960937
4	179	70	5	000960938
4,5	200	84	5	000960939
5	200	84	5	000960940
6	221	103	5	000960941
7	236	106	3	000960942
8	255	117	3	000960943
10	285	132	3	000960945



96T/S6	1	000960952
2-2,5-3-4-5-6 mm		
96T/S8	1	000960933
2-2,5-3-4-5-6-8-10 mm		
96T/S11	1	000960951
2-2,5-3-3,5-4-4,5-5-6-7-8-10 mm		



96T/SP11	1	000960957
2-2,5-3-3,5-4-4,5-5		
6-7-8-10 mm		
96T/SPV	1	000960958
96T/S11		
97TTX/S11		

96T/AS

offset hexagon key wrenches,
with high torque handles



"	L mm	L1 mm	
3/32	153	55	2 000960669
7/64	153	55	2 000960670
1/8	179	70	2 000960671
9/64	179	70	2 000960672
5/32	200	84	2 000960673
3/16	200	84	2 000960674
7/32	221	103	2 000960675
1/4	236	106	2 000960676
5/16	255	117	2 000960678
3/8	285	132	2 000960680



96T/AS8
3/32-7/64-1/8-5/32-3/16-
1/4-5/16-3/8 1 000960682

96T/AS10
3/32-7/64-1/8-9/64-5/32
3/16-7/32-1/4-5/16-3/8 1 000960683

96TBP

ball head offset hexagon key wrenches
with high torque handles



mm	L mm	L1 mm	
2,5	153	55	3 000960685
3	153	55	3 000960686
4	179	70	3 000960687
5	200	84	3 000960688
6	221	103	3 000960689
8	255	117	2 000960690
10	285	132	2 000960692



96TBP/S6
2,5-3-4-5-6-8 mm 1 000960694

97TX

offset key wrenches,
for Torx® head screws



	L mm	L1 mm	
T6	42	16	5 000970006
T7	48	16	5 000970007
T8	48	16	5 000970008
T9	48	16	5 000970009
T10	51	17	5 000970010
T15	54	18	5 000970015
T20	57	19	5 000970020
T25	60	20	5 000970025
T27	64	21	5 000970027
T30	70	24	5 000970030
T40	76	26	5 000970040
T45	83	29	5 000970045
T50	95	32	5 000970050
T55	108	35	5 000970055
T60	120	38	5 000970060



97TX/ST8
T9-T10-T15-T20-T25
T27-T30-T40 1 000970640



97TX/G8
T9-T10-T15-T20-T25
T27-T30-T40 1 000970645



97TX/BG8
T9-T10-T15-T20-T25-T27-T30-T40 1 000970368



97TX/SC8
T9-T10-T15-T20-T25
T27-T30-T40 1 000970064

97TX/SCV
1 000970985



97TX/B13
T6-T7-T8-T9-T10-T15-T20
T25-T27-T30-T40-T45-T50
96N/BV 1 000970650
1 000960651

97BTX

ball head offset key wrenches,
for Torx(R) head screws

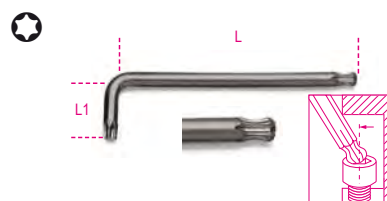

	L mm	L1 mm	
T9	80	16	5 000970109
T10	86	17	5 000970110
T15	90	18	5 000970115
T20	95	19	5 000970120
T25	100	20	5 000970125
T27	105	21	5 000970127
T30	114	24	5 000970130
T40	124	26	5 000970140
T45	133	28	5 000970145
T50	152	32	3 000970150
T55	164	35	3 000970155



97BTX/SC8
T9-T10-T15-T20-T25-T27-T30-T40 1 000970164

97BTX/SCV
1 000970983



97BTX/B8
T9-T10-T15-T20-T25
T27-T30-T40 1 000970159

96N/BV
1 000960651



97BTX-C

ball head offset key wrenches, for Torx® head screws, coloured



	L mm	L1 mm			
T9	80	16		5	000971609
T10	86	17		5	000971610
T15	90	18		5	000971615
T20	95	19		5	000971620
T25	100	20		5	000971625
T27	105	21		5	000971627
T30	114	24		5	000971630
T40	124	26		5	000971640



97BTX-C/SC8	1	000971658
T9-T10-T15-T20-T25-T27-T30-T40		
97BTX-C/SCV	1	000971659

97BTXL

ball head offset key wrenches, long model, for Torx® head screws

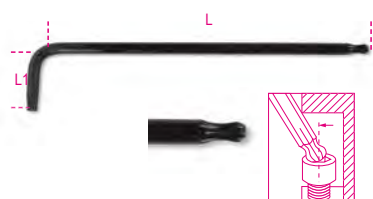

	L mm	L1 mm			
T9	80	15		3	000970309
T10	86	17		3	000970310
T15	100	18		3	000970315
T20	110	19		3	000970320
T25	126	20		3	000970325
T27	140	24		3	000970327
T30	160	28		3	000970330
T40	176	32		3	000970340



97BTXL/SC8	1	000970364
T9-T10-T15-T20-T25-T27-T30-T40		
97BTXL/SCV	1	000970982

97RTX

offset key wrenches for Tamper Resistant Torx® head screws



	L mm	L1 mm			
T6	40	15		5	000970206
T7	45	15		5	000970207
T8	50	16		5	000970208
T9	56	16		5	000970209
T10	62	17		5	000970210
T15	72	17		5	000970215
T20	83	18		5	000970220
T25	90	18		5	000970225
T27	100	20		5	000970227
T30	105	24		5	000970230
T40	112	26		5	000970240
T45	118	26		5	000970245
T50	122	28		3	000970250
T55	128	30		3	000970255



97RTX/SC8	1	000970263
T9-T10-T15-T20-T25-T27-T30-T40		
97RTX/SCV	1	000970984



97RTX/B8	1	000970260
T9-T10-T15-T20-T25-T27-T30-T40		
96N/BV	1	000960651

97TTX

offset key wrenches with handles for Torx® head screws

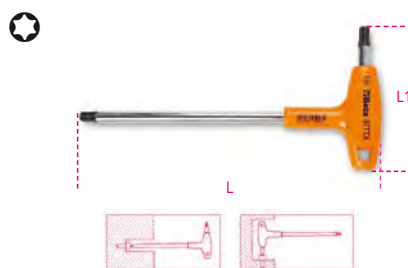

	L mm	L1 mm			
T6	130	52		3	000970706
T7	130	52		3	000970707
T8	139	52		3	000970708
T9	139	52		3	000970709
T10	179	70		3	000970710
T15	179	70		3	000970715
T20	179	70		3	000970720
T25	179	70		3	000970725

	L mm	L1 mm			
T27	200	84		3	000970727
T30	200	84		3	000970730
T40	221	103		3	000970740
T45	236	106		2	000970745
T50	255	117		2	000970750



97TTX/S6	1	000970791
T10-T15-T20-T25-T30-T40		
97TTX/S8	1	000970808
T8-T10-T15-T20-T25-T27-T30-T40		
97TTX/S11	1	000970800
T8-T9-T10-T15-T20-T25-T27-T30-T40-T45-T50		
97TTX/S13	1	000970813
T6-T7-T8-T9-T10-T15-T20-T25-T27-T30-T40-T45-T50		



97TTX/SP11	1	000970840
T8-T9-T10-T15-T20-T25-T27-T30-T40-T45-T50		
96T/SPV	1	000960958
96T/S11		
97TTX/S11		

98XZN

offset key wrenches with XZN® profile



DIN 65253

	L mm	L1 mm			
M5	83	25		5	000980005
M6	89	30		5	000980006
M8	97	32		5	000980008
M10	106	35		5	000980010
M12	116	37		5	000980012
M14	118	45		5	000980014
M16	125	45		5	000980016



98XZN/B5	1	000980650
M5-M6-M8-M10-M12		
96N/BV	1	000960651

99

hook wrenches with square noses, for ring nuts UNI/ISO 2982, 2983



UNI 6752

mm	A mm		
12-14	1,5	3	000990012
16-18-20	1,8	3	000990016
22-25-28	1,8	3	000990022
30-32	2,1	3	000990030
34-36-38	2,4	3	000990034
40-42	2,4	3	000990040
45-50	2,5	3	000990045
52-55-58	2,5	3	000990052
62-65	3,1	3	000990062
68-70-75	3,1	3	000990068
80-85-90	3,8	2	000990080
92-95	4,3	2	000990092
98-100	4,3	2	000990098
105-110-115	4,4	1	000990105
120-125-130	4,9	1	000990120
135-145	6,0	1	000990135
155-165	6,0	1	000990155

99SQ

hook wrenches with square noses for ring nuts



mm	B mm		
15-35	2,7	2	000990215
35-50	3,5	2	000990235
50-80	4,7	2	000990250
80-120	6,2	2	000990280
120-180	7,8	2	000990290

99ST

hook wrenches with round noses for ring nuts



mm	Ø mm	B mm		
15-35	3,0	2,5	2	000990315
35-50	4,0	4,5	2	000990335
50-80	5,0	5,0	2	000990350
80-120	6,0	7,0	2	000990380
120-180	8,0	9,0	2	000990390

99 VN/...

spare nose for item 99ST

	mm		
99ST VN/15	15-35	1	000990295
99ST VN/35	35-50	1	000990296
99ST VN/50	50-80	1	000990297
99ST VN/80	80-120	1	000990298
99ST VN/120	120-180	1	000990299

100

round pin wrench for ring nuts with front holes



mm	L mm	Ø min-max mm		
4,9-5,9	250	18÷100	1	001000001
6,9-7,9				

100/KIT

spare pins for item 100



100/KIT	1	001000010	

111

adjustable wrenches with scales, chrome-plated

- Right-hand rotation of pin
- With mm and inch scale



DIN 3117 ISO 6787

L mm	L" mm	A max mm		
100	4	15	3	001110010
150	6	24	3	001110015
200	8	28	3	001110020
250	10	34	3	001110025
300	12	35	3	001110030
380	15	45	3	001110038
450	18	54	2	001110045
600	24	62	1	001110060

111N

adjustable wrenches with scales, phosphatized

- Left-hand rotation of pin
- With mm and inch scale



DIN 3117 ISO 6787

L mm	L" mm	A max mm		
100	4	15	3	001110210
150	6	24	3	001110215
200	8	28	3	001110220
250	10	34	3	001110225
300	12	35	3	001110230
380	15	45	3	001110238
450	18	54	2	001110245

111G

adjustable wrenches with scales chrome-plated

- Right-hand rotation of pin
- Mm and inch scale
- Ergonomic handle



DIN 3117 ISO 6787

L mm	L" mm	A max mm		
200	8	28	3	001110620
250	10	34	3	001110625
300	12	35	2	001110630

120

ratchet opening single ended bi-hex wrenches

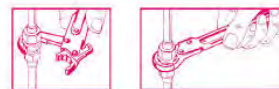

mm	L mm		
10	135	1	001200010
11	135	1	001200011
12	135	1	001200012
13	135	1	001200013
14	135	1	001200014
17	185	1	001200017
19	185	1	001200019
22	230	1	001200022
24	230	1	001200024
27	230	1	001200027
30	320	1	001200030
32	320	1	001200032



120/B6	10-11-13	1	001200050
	17-19-22 mm		
120/BV		1	001200051

123E1/4

bit holder adaptor, 1/4", for 10 mm ratcheting wrenches



mm	L mm		
10	20,6	1	001230010

123Q1/4

quick release adaptor, 1/4", for 10 mm ratcheting wrenches



Ø	L		
mm	mm		
10	17,5	1	001230310

123Q3/8

quick release adaptor, 3/8", for 13 mm ratcheting wrenches



Ø	L		
mm	mm		
13	22,5	1	001230313

123Q1/2

quick release adaptor, 1/2", for 19 mm ratcheting wrenches

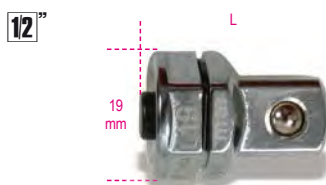

Ø	L		
mm	mm		
19	30,5	1	001230319

123/K4

kit with 4 adapters for ratchet wrenches:
1 bit adapter
3 quick release adapters



123/K4	1	001230504
--------	---	-----------

141

ratcheting combination wrenches, straight series



ISO 21982:2020

Ø	L		
mm	mm		
8x8	136	3	001410008
9x9	143	3	001410009
10x10	160	3	001410010
11x11	168	3	001410011
12x12	174	3	001410012
13x13	180	3	001410013
14x14	193	2	001410014
15x15	200	2	001410015
16x16	216	2	001410016
17x17	233	2	001410017
18x18	239	2	001410018
19x19	250	2	001410019



141/B6	1	001410066
--------	---	-----------



141/S12	1	001410072
---------	---	-----------

142

reversible ratcheting combination wrenches



ISO 21982:2020

Ø	L		
mm	mm		
6x6	136	3	001420006
7x7	136	3	001420007
8x8	136	3	001420008
9x9	143	3	001420009
10x10	159	3	001420010
11x11	168	3	001420011
12x12	174	3	001420012
13x13	180	3	001420013
14x14	190	2	001420014
15x15	200	2	001420015
16x16	216	2	001420016
17x17	233	2	001420017
18x18	239	2	001420018
19x19	248	2	001420019
21x21	285	1	001420021
22x22	285	1	001420022
24x24	325	1	001420024
27x27	355	1	001420027
30x30	420	1	001420030
32x32	420	1	001420032
34x34	482	1	001420034
36x36	482	1	001420036
38x38	482	1	001420038



142/B6	1	001420066
8-10-13-14-17-19 mm		
142/BV6	1	001420076
142/B9	1	001420069
8-10-11-12-13-14-15-17-19 mm		
142/BV9	1	001420079



142/S15	1	001420074
6-7-8-9-10-11-12-13		
14-15-16-17-18-19-22 mm		
142/S17	1	001420068
6-7-8-10-11-12-13-14-15-		
16-17-18-19-21-22-24-27 mm		
142/S19	1	001420075
6-7-8-9-10-11-12		
13-14-15-16-17-18		
19-22-24-27-30-32 mm		

142/SC9I-E

set of 9 reversible ratcheting combination wrenches, with compact support



142/SC9I	1	001420087
8-10-11-12-13-14-15-17-19 mm		
142/SCV9I	1	001420103
142/SC9E	1	001420088
8-10-11-12-13-16-17-18-19 mm		
142/SCV9E	1	001420104

Beta

Beta

142MC

reversible ratcheting combination wrenches, coloured



mm	L mm			
8x8	136		3	001422008
10x10	159		3	001422010
11x11	168		3	001422011
12x12	174		3	001422012
13x13	180		3	001422013
14x14	190		2	001422014
15x15	200		2	001422015
16x16	216		2	001422016
17x17	233		2	001422017
18x18	239		2	001422018
19x19	248		2	001422019



142MC/SC9I	1	001422087
8-10-11-12-13-14-15-17-19 mm		
142MC/SC9E	1	001422088
8-10-11-12-13-16-17-18-19 mm		

142AS

reversible ratcheting combination wrenches



mm	L mm			
5/16x5/16	136		2	001420308
3/8x3/8	159		2	001420310
7/16x7/16	168		2	001420311
1/2x1/2	180		2	001420313
9/16x9/16	190		2	001420314
5/8x5/8	216		2	001420316
11/16x11/16	233		2	001420317
3/4x3/4	248		2	001420319



142AS /8	1	001420330
5/16-3/8-7/16-1/2		
9/16-5/8-11/16-3/4		

142C

ratcheting combination wrenches, straight short series



ISO 21982:2020

mm	L mm			
8x8	88		2	001420108
9x9	96		2	001420109
10x10	96		2	001420110
11x11	100		2	001420111
12x12	104		2	001420112
13x13	108		2	001420113
14x14	114		2	001420114
15x15	118		2	001420115
16x16	122		2	001420116
17x17	128		2	001420117
18x18	132		2	001420118
19x19	138		2	001420119



142C/A12	1	001420175
8-9-10-11-12-13-14		
15-16-17-18-19 mm		

142SN

swivel end ratcheting combination wrenches



ISO 21982:2020

mm	L mm			
7x7	136		2	001420207
8x8	136		2	001420208
9x9	143		2	001420209
10x10	160		2	001420210
11x11	168		2	001420211
12x12	174		2	001420212
13x13	180		2	001420213
14x14	193		2	001420214
15x15	200		2	001420215
16x16	216		2	001420216
17x17	233		2	001420217
18x18	239		2	001420218
19x19	250		2	001420219
22x22	285		1	001420222
24x24	325		1	001420224



142SN/S13	1	001420263
7-8-9-10-11-12-13-14		
15-16-17-18-19 mm		

186

self-locking wrench with automatic take-up device for hexagons, 8 to 32 mm

Ideal for hexagon, Spline, square and Torx® head screws, including damaged screws.



L mm			
260	1	001860008	

187

swivelling, openable wrenches



mm	L mm			
8x9	125		1	001870008
10x11	155		1	001870010
12x13	175		1	001870012
14x15	205		1	001870014
16x17	235		1	001870016



187/B5	1	001870050
8x9-10x11-12x13		
14x15-16x17 mm		

188

ratcheting flat bi-hex ring wrenches for free alternator pulleys



mm	L mm			
10	240		2	001880010
15	322		2	001880015

192

reversible ratcheting double-ended flat bi-hex ring wrenches, 4 in 1



mm	L mm			
8x10/12x13	160		1	001920008
16x17/18x19	230		1	001920016



192/S2
8x10/12x13 mm
16x17/18x19 mm
1 001920070

194
reversible ratcheting wrench
for bits



1/4x5/16 L mm
128 2 001940006

195
ratcheting double-ended flat bi-hex ring
wrenches



ISO 21982:2020

mm	L mm	
8x10	128	2 001950010
12x13	170	2 001950013
14x15	190	2 001950015
16x18	230	2 001950018
17x19	230	2 001950019



195/B5
8x10-12x13-14x15
16x18-17x19 mm
1 001950066

195/BV5
1 001950070

195AS
ratcheting double-ended flat bi-hex ring
wrenches



mm	L mm	
5/16x3/8	128	2 001950606
7/16x1/2	170	2 001950611
9/16x5/8	190	2 001950614
11/16x3/4	230	2 001950617



195AS/B4
5/16x3/8 - 7/16x1/2 -
9/16x5/8 - 11/16x3/4
1 001950654

195FTX/BV4
1 001950520

195P
reversible ratcheting double-ended offset
bi-hex ring wrenches, bent at 15°



ISO 21982:2020

mm	L mm	
8x10	128	2 001950210
12x13	170	2 001950213
14x15	190	2 001950215
16x18	230	2 001950218
17x19	230	2 001950219



195P/B5
8x10-12x13-14x15
16x18-17x19 mm
1 001950266

195/BV5
1 001950070

310
polywelder for PE, PP, PVC
and PVDF pipes and fittings

CE



230V-650 Watt
50 Hz=60Hz
Schuko (CEE 7/7)

	Ø mm	
310/1	16÷50	1 003100001
310/2	16÷63	1 003100002

310B
forms for polywelder item 310



Ø mm	
16	1 003100016
20	1 003100020
25	1 003100025
32	1 003100032
40	1 003100040
50	1 003100050
63	1 003100063

310/C4
polywelder with assortment of 3 forms



310/C4
310/1+310B: Ø 20-25-32
1 003100104
410x260x82 mm - 4,8 kg

310/C8
polywelder with assortment of 7 forms



310/C8
310/2+310B: Ø 16-20-25
32-40-50-63
1 003100108
440x270x120 mm - 7,7 kg

311
heating plates for manual straight
and slanted welding of PE, PP, PVC
and PVDF pipes

CE



230V
50 Hz=60Hz
Schuko (CEE 7/7)

	Ø mm	Watt	
311/1	120	300	1 003110001
311/2	190	900	1 003110002

330
pipe cutters for steel gas pipes

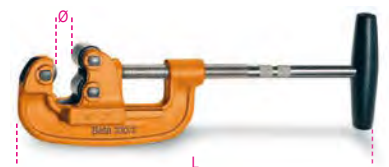

	Ø mm - "	L mm	
330/2	10÷60 1/8"÷ 2"	380	1 003300002
330/4	60÷115 2"÷ 4"	585	1 003300004



330R/A

spare cutters for item 330 wheels for steel pipes



	Ø mm	S mm		
330R/A2	32	7	1	003300012
330R/A4	42	9	1	003300014

330R/I

spare cutter wheel for item 330 for stainless steel pipes



	Ø mm	S mm		
330R/I2	32	7	1	003300024
330R/I4	32	9	1	003300034

331L

ratcheting pipe cutter for copper and light alloy pipes



	Ø mm - "	L mm		
8÷29		180	1	003310008
5/16"÷1"1/8				

331LR/L

spare knife for pipe cutter 331L

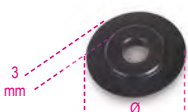

	Ø mm			
331LR/L	18	1	003310058	

332

mini pipe cutter for copper and light alloy pipes



	Ø mm - "	L mm		
3÷16		59	2	003320001
1/8"÷5/8"				

334

pipe cutter for copper and light alloy pipes



	Ø mm - "	L mm		
3÷30		150	1	003340001
1/8"÷1"1/8				

334R

spare cutter wheel for items 332 and 334 for copper and light alloy pipes



	Ø mm			
334R	18	1	003340021	

334R/I

spare cutter wheel for items 332 and 334 for stainless steel pipes



	Ø mm			
334R/I	18	1	003340023	

336

telescopic pipe cutter for copper and light alloy pipes



	Ø mm - "	L mm		
6÷38		160	1	003360001
1/4"÷1"1/2				

338

telescopic pipe cutter, fast advance for copper, light alloys and plastic pipes



	Ø mm - "	L mm		
6÷67		290	1	003380001
1/4"÷2"5/8				

338R

spare cutter wheel for items 331L, 336 and 338 for copper and light alloy pipes



	Ø mm			
338R	18,5	1	003380022	

338R/I

spare cutter wheel for items 336 and 338 for stainless steel pipes



	Ø mm			
338R/I	21,8	1	003380023	

338RP

spare cutter wheel for items 336 and 338 for plastic pipes



	Ø mm			
338RP	21,9	1	003380025	

339A

telescopic pipe cutter, fast advance for plastic pipes



	Ø mm - "	L mm		
50÷127		345	1	003390011
2"÷5"				

339A/R

spare cutter wheels for item 339A



	Ø mm			
339A/R	42	1	003390061	

340

multilayer pipe cutting pliers,
max. \varnothing 26 mm
PTFE-coated blade
4 support rollers making it easier to rotate pipe during cutting jobs
system for cutting corrugated pipes built into handle
lightweight magnesium body



\varnothing max	L		
mm	mm	1	003400001
26			

340RL

spare blade for item 340



340RL	1	003400010
-------	---	-----------

341

pipe cutting pliers for plastic pipes



\varnothing	L		
mm	mm	1	003410001
0÷25	190		

341RL

spare blade for item 341



341RL	1	003410010
-------	---	-----------

341B

ratchet-type shears for plastic pipes



\varnothing	L		
mm	mm	1	003410051
0÷35	195		

341B/RM

spare spring for item 341B

341B/RM	1	003410061
---------	---	-----------

341B/RL

spare blade for item 341B



341B/RL	1	003410060
---------	---	-----------

342

Ratchet-type shears for plastic pipes



\varnothing	L		
mm - "	mm	1	003420030
0÷42	200		
1"5/8			

342MOL

spare spring for item 342

342MOL	1	003420033
--------	---	-----------

342RL

spare blade for item 342



342RL	1	003420032
-------	---	-----------

342A

ratchet-type shears for plastic pipes



\varnothing	L		
mm - "	mm	1	003420101
0÷50	270		
2"			

342A/MOL

spare spring for item 342A

342A/MOL	1	003420111
----------	---	-----------

342A/RL

spare blade for item 342A



342A/RL	1	003420110
---------	---	-----------

342P

ratchet-type shears for plastic pipes, made from magnesium alloy



\varnothing	L		
mm - "	mm	1	003420121
0÷50	260		
2"			

342P/RL

spare blade for item 342P



342P/RL	1	003420130
---------	---	-----------

345

pipe reamer metal body

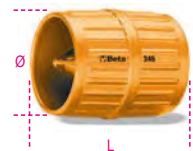

\varnothing	L		
mm - "	mm	5	003450001
3÷42	58		
1/8"÷1"5/8			



345U

pipe reamer for stainless steel, steel, copper and light alloys



\varnothing mm - " 4÷36
 L mm 60
 1 003450050

345C

multilayer pipe gauge



\varnothing mm 16-20-26-32
 1 003450032

345SB

deburrer with revolving replacement blade



L mm 150
 5 003450010

345SB/R

spare blade for item 345SB



345SB/R 3 003450015

349

tube flaring tool with clutch, for copper and light alloy pipes



\varnothing mm - " 6-8-10-12-14-15-16-18
 (1/8-3/16-1/4-5/16
 3/8-1/2-5/8-3/4)
 1 003490001

270x200x50 mm - 2,7 kg

349/SMM

metric slide for item 349



\varnothing mm 6-8-10-12-14-15-16-18
 1 003490011

349/SMAS

inch slide for item 349



\varnothing mm 1/8-3/16-1/4-5/16
 3/8-1/2-5/8-3/4
 1 003490012

350

tube flaring tool for copper and light alloy pipes



\varnothing mm 4-4,75-6-8
 L mm 175
 A mm 104
 10-12-14
 1 003500001

351C

pipe cutter and tube flaring tool



351C 1 003510010

334 \varnothing 3÷30 mm (1/8"÷1"1/8)
 350 \varnothing 4÷14 mm
 351P \varnothing 4-4,75-6-8-10-12-14 mm

225x150x45 mm - 1,6 kg

351P

inserts for tube flaring tool item 350



\varnothing mm 351P 4 4
 3 003510101
 351P 4,75 4,75
 3 003510102
 351P 6 6
 3 003510103
 351P 8 8
 3 003510104
 351P 10 10
 3 003510105
 351P 12 12
 3 003510106
 351P 14 14
 3 003510107

352U

adjustable tube flaring tool for copper and light alloy pipes

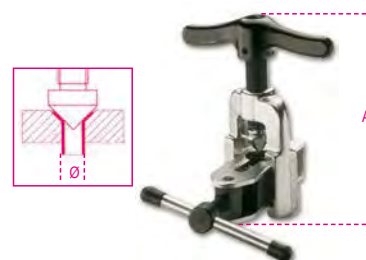

\varnothing mm - " 5÷16
 A mm 130
 3/16÷5/8
 1 003520101

352C/U

pipe cutter, deburrer and adjustable tube flaring tool



352C/U 1 003520110

334 \varnothing 3÷30 mm (1/8"÷1"1/8)

345SB

352U \varnothing 5÷16 mm (3/16"÷5/8")

335x145x60 mm - 2120 g

353N

tube expanding pliers, with interchangeable forms



L mm 380
 1 003530201

353NM

forms for tube expanding pliers item 353N



Ø mm	A mm		
10	7	1	003530210
12	10	1	003530212
14	10	1	003530214
16	12	1	003530216
18	12	1	003530218
22	13	1	003530222

353N/C6

tube expanding pliers item 353N with forms item 353NM



353N/C6 1 003530300

353N
353NM Ø 10-12-14-16-18-22 mm
420x185x60 mm - 2,2 kg

355

combination spud wrench, five steps

12"



Ø "	L mm		
3/8"-1/2"	90	2	003550001
3/4"-1"			

357F3

three-vial spirit level

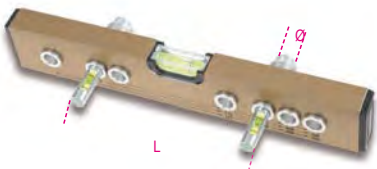

Ø "	L mm		
3/8" / 1/2"	90=220	1	003570100

357R/F3

spare vial for item 357F3



357R/F3 1 003570101

358

tools for chamfering plastic pipes



	Ø mm		
358/1	16÷110	1	003580001
358/2	40÷250	1	003580002

358RL

spare blade for items 358/1 and 358/2



358RL 1 003580011

359

universal drain wrench



Ø "	L mm	A mm		
1"-1 1/4"	160	140	1	003590001

359CH

drain adaptor, cross-shape for item 359



Ø "	L mm		
1 1/2"	74	1	003590005

360

pipe wrenches, Stillson pattern



L mm	Ø max "	Ø max mm		
250	1" gas	34	1	003600025
350	1 1/2" gas	49	1	003600035
450	2" gas	60	1	003600045
600	2 1/2" gas	76	1	003600060
900	3 1/2" gas	102	1	003600090

360R/...

spare parts kit for item 360 with moving jaw and ring nut.

360R250	1	003600225
360R350	1	003600235
360R450	1	003600245
360R600	1	003600260
360R900	1	003600290

362

heavy duty pipe wrenches



L mm	Ø max "	Ø max mm		
200	1" gas	34	1	003620020
250	1 1/2" gas	49	1	003620025
300	2" gas	60	1	003620030
350	2" gas	60	1	003620035
450	2 1/2" gas	76	1	003620045
600	3" gas	90	1	003620060
900	5" gas	140	1	003620090

362R/...

spare parts kit for item 362 with: fixed jaw, moving jaw; ring nut; lockpin.

362R 200	1	003620220
362R 250	1	003620225
362R 300	1	003620230
362R 350	1	003620235
362R 450	1	003620245
362R 600	1	003620260
362R 900	1	003620290

363

heavy duty pipe wrenches
made from light alloy



L mm	Ø max "	Ø max mm		
350	2" gas	60	1	003630035
450	2 1/2" gas	76	1	003630045
600	3" gas	90	1	003630060
900	5" gas	140	1	003630090
1200	6" gas	165	1	003630120

363R/...

spare parts kit for item 363
with: fixed jaw; moving jaw; ring nut; lockpin.

363R 350	1	003630235
363R 450	1	003630245
363R 600	1	003630260
363R 900	1	003630290
363R 1200	1	003630320

365

heavy duty pipe wrenches,
offset pattern made from light alloy



L mm	Ø max "	Ø max mm		
350	2" gas	60	1	003650035
450	2 1/2" gas	76	1	003650045

365R/...

spare parts kit for item 365
with: fixed jaw; moving jaw; ring nut; lockpin.

365R 350	1	003650235
365R 450	1	003650245

366

pipe wrenches, light pattern



L mm	Ø max "	Ø max mm		
175	1" gas	34	1	003660017
225	1 1/2" gas	49	1	003660022
275	2" gas	60	1	003660027
300	2 1/2" gas	76	1	003660030
350	3" gas	90	1	003660035

374

pipe wrenches,
Swedish pattern, 45° slim jaws



DIN 5234

L mm	Ø max "	Ø max mm		
240	1/2" gas	21	1	003740024
320	1" gas	34	1	003740032
410	1 1/2" gas	49	1	003740041
550	2" gas	60	1	003740055
630	3" gas	90	1	003740063

375

pipe wrench, Swedish pattern,
45° flat jaws



DIN 5234

L mm	Ø max "	Ø max mm		
320	1" gas	34	1	003750032
410	1 1/2" gas	49	1	003750041
550	2" gas	60	1	003750055

376

pipe wrenches,
Swedish pattern, 90° flat jaws



DIN 5234

L mm	Ø max "	Ø max mm		
320	1" gas	34	1	003760032
410	1 1/2" gas	49	1	003760041
550	2" gas	60	1	003760055
630	3" gas	90	1	003760063

378

pipe wrenches,
Swedish pattern, 45° slim jaws



DIN 5234

L mm	Ø max "	Ø max mm		
250	1/2" gas	21	1	003780025
320	1" gas	34	1	003780032
410	1 1/2" gas	49	1	003780041
550	2" gas	60	1	003780055
650	3" gas	90	1	003780065

374R/...

complete spare parts kit for items 374 - 375 -
376 - 378
with ring nut and ring nut stop

374R 240	1	003740724
x 374/240-378/250		
374R 320	1	003740732
x 374/320-376/320-378/320		
374R 410	1	003740741
x 374/410-375/410-376/410-378/410		
374R 550	1	003740755
x 374/550-376/550-378/550		
374R 630	1	003740763
x 374/630-378/650		

383

reversible strip pipe wrenches



	Ø max "	Ø max mm	L mm		
383/1	3" gas	90	300	1	003830001
383/2	8" gas	220	300	1	003830002

383R

spare strips for item 383



	S mm		
383R/1	27	1	003830010
383R/2	27	1	003830015

384

reversible chain pipe wrench



	Ø max "	Ø max mm	L mm		
4" gas		115	300	1	003840032

384RC

spare chain for item 384



384RC	1	003840033
-------	---	-----------

386A

heavy duty reversible chain pipe wrenches



	∅ max	L mm		
386A/3	4" gas 115 mm	900	1	003860003
386A/4	6" gas 168 mm	900	1	003860004
386A/5	8" gas 220 mm	1100	1	003860005
386A/6	12" gas 324 mm	1300	1	003860006

386A/RC

spare chains for item 386A



386A/3/RC	1	003860013
386A/4/RC	1	003860014
386A/5/RC	1	003860015
386A/6/RC	1	003860016

388

pipe benders for thin walled copper, light alloy and mild steel pipes

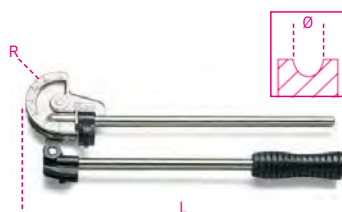

∅ mm	L mm	R mm		
6	305	18,0	1	003880006
8	315	23,5	1	003880008
10	350	31,0	1	003880010
12	360	31,0	1	003880012
14	455	46,5	1	003880014
15	465	46,5	1	003880015
16	465	46,5	1	003880016

388A

pipe bending pliers for thin walled copper and light alloy pipes



	∅ mm	L mm		
388A/1	6-8-10 mm	220	1	003880051
388A/2	1/4"-5/16"-3/8"	220	1	003880055

388C/C8

pipe bender with 7 forms for thin walled copper and light alloy pipes



	∅ mm		
388C/C8	10-12-14-16 18-20-22	1	003880200

400x330x110 mm - 3,6 kg

392C

adjustable drain tap pliers



∅ mm	L mm		
25÷65	260	1	003920100

392RG/C

spare jaw protectors for item 392C, pair



392RG/C	1	003920101
---------	---	-----------

393

water tap wrench



L mm		
270	1	003930001

395

hinged water tap wrench



∅ mm	L mm		
15÷32 mm 5/8"÷1"1/4	240	1	003950001

395T

telescopic hinged water tap wrench



∅ mm	L mm		
10÷32 mm 3/8"÷1"1/4	250÷430	1	003950100

399

pivoting clamp vices

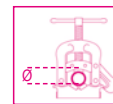

∅ mm	L min mm		
10÷60 mm 1/8"÷2"	220	1	003990005
10÷89 mm 1/8"÷3"	290	1	003990010

399R/...

spare kit for item 399 composed of two lower jaws and one upper jaw



399RG1/8-2"	1	003990105
399RG1/8-3"	1	003990110



410

twist drills with cylindrical shanks, short series HSS, rolled

R ≤ 650 N/mm²
HV ~ 750÷820



DIN 338 ISO 235

Ø mm	L mm	L1 mm	
0,50	22	6	10 004100030
1,00	34	12	10 004100040
1,25	38	16	10 004100043
1,50	40	18	10 004100046
1,75	46	22	10 004100049
2,00	49	24	10 004100052
2,25	53	27	10 004100055
2,50	57	30	10 004100058
2,75	61	33	10 004100061
3,00	61	33	10 004100064
3,20	65	36	10 004100066
3,25	65	36	10 004100067
3,50	70	39	10 004100070
3,75	70	39	10 004100073
4,00	75	43	10 004100076
4,20	75	43	10 004100078
4,25	75	43	10 004100079
4,50	80	47	10 004100082
4,75	80	47	10 004100085
5,00	86	52	10 004100088
5,25	86	52	10 004100091
5,50	93	57	10 004100094
5,75	93	57	10 004100097
6,00	93	57	10 004100100
6,25	101	63	10 004100103
6,50	101	63	10 004100106
6,75	109	69	10 004100109
7,00	109	69	10 004100112
7,50	109	69	10 004100118
8,00	117	75	10 004100124
8,50	117	75	10 004100130
9,00	125	81	5 004100136
9,50	125	81	5 004100142
10,00	133	87	5 004100148
10,50	133	87	5 004100172
11,00	142	94	5 004100184
11,50	142	94	5 004100196
12,00	151	101	5 004100210
12,50	151	101	5 004100222
13,00	151	101	5 004100234
14,00	160	108	5 004100242
15,00	169	114	5 004100250
16,00	178	120	5 004100258
17,00	184	125	3 004100262
18,00	191	130	3 004100266
19,00	198	135	3 004100270
20,00	205	140	3 004100274



410/SP19	1 004100419
Ø 1÷10 x 0,5 mm	
410/SPV1	1 004100420
410/SP25	1 004100425
Ø 1÷13 x 0,5 mm	
410/SPV2	1 004100426



410/SEL19
Ø 1÷10 x 0,5 mm

1 004100418

410MIX/SEL19

set of 13 twist drills, item 410, and 6 twist drills with hard metal insets



410MIX/SEL19

1 004100417



Ø 1 - 1,5 - 2 - 2,5 - 3 - 3,5 - 4
4,5 - 5 - 5,5 - 6 - 8 - 10 mm

Ø 4 - 5 - 6 - 8 - 9 - 10 mm

410A

twist drills with cylindrical shanks, short series, HSS, rolled, with small tang

R ≤ 650 N/mm²
HV ~ 750÷820



DIN 338 ISO 235

Ø mm	L mm	L1 mm	
13,50	160	108	5 004100281
14,00	160	108	5 004100283
14,50	169	114	5 004100285
15,00	169	114	5 004100287
15,50	178	120	5 004100289
16,00	178	120	5 004100291
16,50	184	125	3 004100292
17,00	184	125	3 004100293
17,50	191	130	3 004100294
18,00	191	130	3 004100295
18,50	198	135	3 004100296
19,00	198	135	3 004100297
19,50	205	140	3 004100298
20,00	205	140	3 004100299

410AS

twist drills with cylindrical shanks, short series, HSS, rolled, in inches

R ≤ 650 N/mm²
HV ~ 750÷820



ANSI B94

Ø "	L mm	L1 mm	
1/16	48	22	10 004100371
5/64	51	25	10 004100372
3/32	57	32	10 004100373
7/64	67	38	10 004100374
1/8	70	41	10 004100375
9/64	73	44	10 004100376
5/32	79	51	10 004100377
11/64	83	54	10 004100378
3/16	89	59	10 004100379
13/64	92	62	10 004100380
7/32	95	64	10 004100381
15/64	98	67	10 004100382
1/4	102	70	10 004100383
17/64	105	73	10 004100384
9/32	108	75	10 004100385
19/64	111	78	10 004100386
5/16	114	81	10 004100387
21/64	117	84	10 004100388
11/32	121	87	5 004100389
23/64	124	89	5 004100390
3/8	127	92	5 004100391



410AS/SP21

Ø 1/16-5/64-3/32-7/64
1/8-9/64-5/32-11/64-3/16
13/64-7/32-15/64-1/4
17/64-9/32-19/64-5/16
21/64-11/32-23/64-3/8

410AS/SPV1

1 004100429

1 004100430



410AS/SEL21

Ø 1/16-5/64-3/32-7/64
1/8-9/64-5/32-11/64-3/16
13/64-7/32-15/64-1/4
17/64-9/32-19/64-5/16
21/64-11/32-23/64-3/8

1 004100433

Beta

412

twist drills with cylindrical shanks,
short series HSS entirely ground glossy
finishing

R ≤ 800 N/mm²
HV ~ 750+820



DIN 338 ISO 235

Ø mm	L mm	L1 mm		
0,50	22	6	10	004120030
1,00	34	12	10	004120040
1,25	38	16	10	004120043
1,50	40	18	10	004120046
1,75	46	22	10	004120049
2,00	49	24	10	004120052
2,25	53	27	10	004120055
2,50	57	30	10	004120058
2,75	61	33	10	004120061
3,00	61	33	10	004120064
3,25	65	36	10	004120067
3,50	70	39	10	004120070
3,75	70	39	10	004120073
4,00	75	43	10	004120076
4,25	75	43	10	004120079
4,50	80	47	10	004120082
4,75	80	47	10	004120085
5,00	86	52	10	004120088
5,25	86	52	10	004120091
5,50	93	57	10	004120094
5,75	93	57	10	004120097
6,00	93	57	10	004120100
6,25	101	63	10	004120103
6,50	101	63	10	004120106
6,75	109	69	10	004120109
7,00	109	69	10	004120112
7,25	109	69	5	004120115
7,50	109	69	5	004120118
7,75	117	75	5	004120121
8,00	117	75	5	004120124
8,25	117	75	5	004120127
8,50	117	75	5	004120130
8,75	125	81	5	004120133
9,00	125	81	5	004120136
9,25	125	81	5	004120139
9,50	125	81	5	004120142
9,75	133	87	5	004120145
10,00	133	87	5	004120148
10,25	133	87	5	004120149
10,50	133	87	5	004120150
10,75	142	94	5	004120151
11,00	142	94	5	004120152
11,25	142	94	5	004120153
11,50	142	94	5	004120154
11,75	142	94	5	004120155
12,00	151	101	5	004120156
12,25	151	101	5	004120157
12,50	151	101	5	004120158
12,75	151	101	5	004120159
13,00	151	101	5	004120160



412/SP19	1	004120419
Ø 1÷10 x 0,5 mm		
412/SPV1	1	004120420
412/SP25	1	004120425
Ø 1÷13 x 0,5 mm		
412/SPV2	1	004120426
412/SP49	1	004120449
Ø 1÷13 x 0,25 mm		
412/SPV4	1	004120451

Beta

Quality Tools

412/C150



412/C150 1 004120450

412	Ø 3 mm	n.
	Ø 1 - 1,5 - 2 - 2,5 - 3 - 3,5 - 4 - 4,5 - 5 mm	10
	Ø 5,5 - 6 - 6,5 - 7 - 7,5 - 8 - 8,5 - 9 - 9,5 - 10 mm	5

365x230x47 mm - 3,3 kg



412/SP91 1 004120452

Ø 1÷10 x 0,10 mm

412A

twist drills with cylindrical shanks,
short series, HSS,
entirely ground, burnished,
with small tang

R ≤ 800 N/mm²
HV ~ 750+820



DIN 338 ISO 235

Ø mm	L mm	L1 mm		
13,50	160	108	3	004120202
14,00	160	108	3	004120204
14,50	169	114	3	004120206
15,00	169	114	3	004120208
15,50	178	120	3	004120210
16,00	178	120	3	004120212
16,50	184	125	1	004120213
17,00	184	125	1	004120214
17,50	191	130	1	004120215
18,00	191	130	1	004120216
18,50	198	135	1	004120217
19,00	198	135	1	004120218
19,50	205	140	1	004120219
20,00	205	140	1	004120220

412C

twist drills with cylindrical shanks,
extra-short series, HSS,
entirely ground, burnished

R ≤ 800 N/mm²
HV ~ 750+820



DIN 1897 ISO 235

Ø mm	L mm	L1 mm		
3,00	46	16	10	004120288
3,25	49	18	10	004120289
3,50	52	20	10	004120290
4,00	55	22	10	004120292
4,50	58	24	10	004120294
5,00	62	26	10	004120296
5,50	66	28	10	004120298
6,00	66	28	10	004120300
6,5	70	31	10	004120301
7,00	74	34	10	004120302
7,5	74	34	5	004120303
8,00	79	37	5	004120304

412L

twist drills with cylindrical shanks,
long series, HSS entirely ground
burnished

R ≤ 800 N/mm²
HV ~ 750+820



DIN 340

Ø mm	L mm	L1 mm		
2,00	85	56	10	004120232
2,50	95	62	10	004120234
3,00	100	66	10	004120236
3,50	112	73	10	004120238
4,00	119	78	10	004120240
4,50	126	82	10	004120242
5,00	132	87	10	004120244
5,50	139	91	10	004120246
6,00	139	91	10	004120248
6,50	148	97	5	004120250
7,00	156	102	5	004120252
8,00	165	109	5	004120256
9,00	175	115	5	004120260
10,00	184	121	5	004120264

Beta

412XL

twist drills with cylindrical shanks,
extra-long series, HSS,
entirely ground

R ≤ 800 N/mm²
HV ~ 750-820



DIN 1869/1

Ø mm	L mm	L1 mm		
3,00	150	100	1	004120520
3,50	165	115	1	004120522
4,00	175	120	1	004120524
4,50	185	125	1	004120526
5,00	195	135	1	004120528
5,50	205	140	1	004120530
6,00	205	140	1	004120532
6,50	215	150	1	004120534
7,00	225	155	1	004120536
7,50	225	155	1	004120538
8,00	240	165	1	004120540
8,50	240	165	1	004120542
9,00	250	175	1	004120544
9,50	250	175	1	004120546
10,00	265	185	1	004120548
10,50	265	185	1	004120550
11,00	280	195	1	004120552
12,00	295	205	1	004120556
13,00	295	205	1	004120560

414

twist drills with cylindrical shanks,
short series, HSS-TiN entirely ground

R ≤ 900 N/mm²
HV 0,05 ~ 2500



DIN 338 ISO 235

Ø mm	L mm	L1 mm		
1,00	34	12	10	004140040
1,25	38	16	10	004140042
1,50	40	18	10	004140046
1,75	46	22	10	004140048
2,00	49	24	10	004140052
2,25	53	27	10	004140054
2,50	57	30	10	004140058
2,75	61	33	10	004140060
3,00	61	33	10	004140064
3,25	65	36	10	004140066
3,50	70	39	10	004140070
3,75	70	39	10	004140072
4,00	75	43	10	004140076
4,25	75	43	10	004140078
4,50	80	47	10	004140082
4,75	80	47	10	004140084
5,00	86	52	10	004140088
5,25	86	52	10	004140090
5,50	93	57	10	004140094
5,75	93	57	10	004140096
6,00	93	57	10	004140100
6,25	101	63	10	004140102
6,50	101	63	10	004140106
6,75	109	69	10	004140108
7,00	109	69	10	004140112
7,25	109	69	5	004140114
7,50	109	69	5	004140118
7,75	117	75	5	004140120
8,00	117	75	5	004140124
8,25	117	75	5	004140125
8,50	117	75	5	004140130
8,75	125	81	5	004140132
9,00	125	81	5	004140136
9,25	125	81	5	004140138
9,50	125	81	5	004140142
9,75	133	87	5	004140144

Ø mm	L mm	L1 mm		
10,00	133	87	5	004140148
10,50	133	87	5	004140150
11,00	142	94	5	004140152
11,50	142	94	5	004140154
12,00	151	101	5	004140156
12,50	151	101	5	004140158
13,00	151	101	5	004140160



414/SP19	Ø 1÷10 x 0,5 mm	1	004140419
414/SPV1		1	004140420
414/SP25	Ø 1÷13 x 0,5 mm	1	004140425
414/SPV2		1	004140426
414/SP49	Ø 1÷13 x 0,25 mm	1	004140429
414/SPV4		1	004140430

414/C116



414/C116		1	004140450
414	Ø 1 - 1,5 - 2 - 2,5 - 3 - 3,5 - 4 - 4,5 - 5 mm	n.	10
	Ø 5,5 - 6 - 6,5 - 7 - 7,5 - 8 mm		3
	Ø 8,5 - 9 - 9,5 - 10 mm		2
☞ 365x230x47 mm - 2,7 Kg			

415

twist drills with cylindrical shanks,
short series, HSS-CO 8%
entirely ground

R ≤ 1400 N/mm²
HV ~ 850-920



DIN 338 ISO 235

Ø mm	L mm	L1 mm		
0,50	22	6	10	004150029
1,00	34	12	10	004150040
1,25	38	16	10	004150043
1,50	40	18	10	004150046
1,75	46	22	10	004150049
2,00	49	24	10	004150052
2,25	53	27	10	004150055

Ø mm	L mm	L1 mm		
2,50	57	30	10	004150058
2,75	61	33	10	004150061
3,00	61	33	10	004150064
3,25	65	36	10	004150067
3,50	70	39	10	004150070
3,75	70	39	10	004150073
4,00	75	43	10	004150076
4,25	75	43	10	004150079
4,50	80	47	10	004150082
4,75	80	47	10	004150085
5,00	86	52	10	004150088
5,25	86	52	10	004150091
5,50	93	57	10	004150094
5,75	93	57	10	004150097
6,00	93	57	10	004150100
6,25	101	63	10	004150103
6,50	101	63	10	004150106
6,75	109	69	10	004150109
7,00	109	69	10	004150112
7,25	109	69	5	004150115
7,50	109	69	5	004150118
7,75	117	75	5	004150121
8,00	117	75	5	004150124
8,25	117	75	5	004150127
8,50	117	75	5	004150130
8,75	125	81	5	004150133
9,00	125	81	5	004150136
9,25	125	81	5	004150139
9,50	125	81	5	004150142
9,75	133	87	5	004150145
10,00	133	87	5	004150148
10,25	133	87	5	004150149
10,50	133	87	5	004150150
10,75	142	94	5	004150151
11,00	142	94	5	004150152
11,25	142	94	5	004150153
11,50	142	94	5	004150154
11,75	142	94	5	004150155
12,00	151	101	5	004150156
12,25	151	101	5	004150157
12,50	151	101	5	004150158
12,75	151	101	5	004150159
13,00	151	101	5	004150160
14,00	160	108	3	004150164
15,00	169	114	3	004150168
16,00	178	120	3	004150172
17,00	186	125	1	004150174
18,00	194	130	1	004150176
19,00	202	135	1	004150178
20,00	210	140	1	004150180



415/SP19	Ø 1÷10 x 0,5 mm	1	004150419
415/SPV1		1	004150420
415/SP25	Ø 1÷13 x 0,5 mm	1	004150425
415/SPV2		1	004150426
415/SP49	Ø 1÷13 x 0,25 mm	1	004150431
415/SPV4		1	004150432



415/C116



415/C116		1	004150450	
415	Ø 1 - 1,5 - 2 - 2,5 - 3 - 3,5 - 4 - 4,5 - 5 mm			n.
	Ø 5,5 - 6 - 6,5 - 7 - 7,5 - 8 mm			10
	Ø 8,5 - 9 - 9,5 - 10 mm			3
				2
	365x230x47 mm - 2,7 kg			



415/SP91		1	004150460
Ø 1=10 x 0,10 mm			

415CO

twist drills with cylindrical shanks, short series, HSS-CO 5%, entirely ground
 $R \leq 1200 \text{ N/mm}^2$
 $HV \sim 800+860$



DIN 338 ISO 235

Ø mm	L mm	L1 mm	
1,00	34	12	10 004150310
1,50	40	18	10 004150312
2,00	49	24	10 004150314
2,50	57	30	10 004150316
3,00	61	33	10 004150320
3,50	70	39	10 004150322
4,00	75	43	10 004150324
4,50	80	47	10 004150326
5,00	86	52	10 004150328
5,50	93	57	10 004150330
6,00	93	57	10 004150332
6,50	101	63	10 004150334
7,00	109	69	10 004150336
7,50	109	69	5 004150338
8,00	117	75	5 004150340
8,50	117	75	5 004150342
9,00	125	81	5 004150344
9,50	125	81	5 004150346
10,00	133	87	5 004150348
10,50	133	87	5 004150350
11,00	142	94	5 004150352
11,50	142	94	5 004150354
12,00	151	101	5 004150356
12,50	151	101	5 004150358
13,00	151	101	5 004150360

415CO-A

twist drills with cylindrical shanks, short series, HSS-CO 5%, entirely ground
 $R \leq 1200 \text{ N/mm}^2$
 $HV \sim 800+860$



DIN 338

Ø mm	L mm	L1 mm	
14,00	160	108	3 004150364
15,00	169	114	3 004150366
16,00	178	120	3 004150368
17,00	184	125	1 004150370
18,00	191	130	1 004150372
19,00	198	135	1 004150374
20,00	205	140	1 004150376



DIN 338

415CO/SP19		1	004150421
Ø 1=10 x 0,5 mm			
415/SPV1		1	004150420

415C

twist drills with cylindrical shanks, extra-short series, HSS-CO 5%, entirely ground
 $R \leq 1200 \text{ N/mm}^2$
 $HV \sim 800+860$



DIN 1897 ISO 235

Ø mm	L mm	L1 mm	
3,00	46	16	10 004150288
3,25	49	18	10 004150289
3,50	52	20	10 004150290
4,00	55	22	10 004150292
4,50	58	24	10 004150294
5,00	62	26	10 004150296
5,50	66	28	10 004150298
6,00	66	28	10 004150300
6,50	70	31	10 004150301
7,00	74	34	10 004150302
7,50	74	34	5 004150303
8,00	79	37	5 004150304



415L

twist drills with cylindrical shanks, long series, HSS-CO 5%, entirely ground
 $R \leq 1200 \text{ N/mm}^2$
 $HV \sim 800+860$



DIN 340

Ø mm	L mm	L1 mm	
3,00	100	66	10 004150236
3,50	112	73	10 004150238
4,00	119	78	10 004150240
4,50	126	82	10 004150242
5,00	132	87	10 004150244
5,50	139	91	10 004150246
6,00	139	91	10 004150248
6,50	148	97	5 004150250
7,00	156	102	5 004150252
8,00	165	109	5 004150256
9,00	175	115	5 004150260
10,00	184	121	5 004150264

416

drill with cylindrical shank, specially ground, with two cutter pairs

$R \leq 900 \text{ N/mm}^2$
 $HV \sim 820+850$

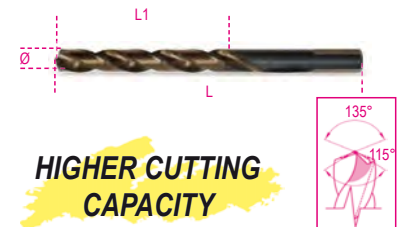

DIN 338

Ø mm	L mm	L1 mm	
1,00	34	12	10 004160010
1,50	40	18	10 004160015
2,00	49	24	10 004160020
2,50	57	30	10 004160025
3,00	61	33	10 004160030
3,50	70	39	10 004160035
4,00	75	43	10 004160040
4,50	80	47	10 004160045
5,00	86	52	10 004160050
5,50	93	57	10 004160055
6,00	93	57	10 004160060
6,50	101	63	10 004160065
7,00	109	69	10 004160070
7,50	109	69	5 004160075
8,00	117	75	5 004160080
8,50	117	75	5 004160085
9,00	125	81	5 004160090
9,50	125	81	5 004160095
10,00	133	87	5 004160100

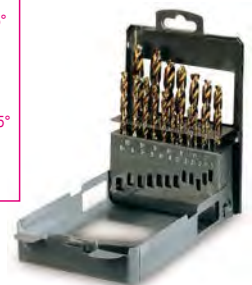
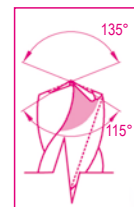

416/SP19		1	004160419
Ø 1=10 x 0,5 mm			

417

helical cylindrical masonry drill bits, short series, made from milled steel with hard metal plates



DIN 8039

Ø mm	L mm		
3	70	10	004170003
4	75	10	004170004
5	85	10	004170005
5L	150	5	004170105
6	100	10	004170007
6L	150	5	004170106
7	120	10	004170009
8	120	10	004170010
8L	200	5	004170113
9	120	10	004170011
10	120	10	004170012
10L	200	5	004170120
12	150	10	004170014
12L	200	5	004170125
14	150	5	004170016
16	150	5	004170018



417/SP8
Ø 3-4-5-6-8-9-10-12 mm

1 004170100

419

hammer drill bits with milled shanks and hard metal plates
HVA~ 1650

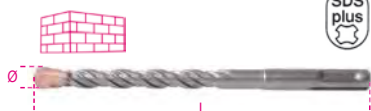

DIN 8039

Ø mm	L mm		
4	110	10	004190002
5	110	10	004190004
5	160	10	004190006
6	110	10	004190012
6	160	10	004190014
6	210	10	004190016
7	160	10	004190028
8	110	10	004190030
8	160	10	004190032
8	210	10	004190034
8	260	10	004190036
8	310	10	004190038
8	460	10	004190042
9	160	5	004190044
10	160	5	004190050
10	210	5	004190052
10	260	5	004190054
10	310	5	004190056

Ø mm	L mm		
10	460	5	004190060
12	160	5	004190064
12	210	5	004190066
12	260	5	004190068
12	460	5	004190074
14	160	3	004190086
14	260	3	004190090
14	310	3	004190092
14	460	3	004190096
16	210	3	004190112
16	250	3	004190114
16	300	3	004190116
16	450	3	004190120
18	250	1	004190124
20	310	1	004190128

419T

hammer drill bits with milled shanks, 4 spirals and 4 cutters

HVA~ 1650



Ø mm	L mm		
5	110	5	004190604
5	160	5	004190606
6	110	5	004190612
6	160	5	004190614
6	210	5	004190616
7	160	5	004190628
8	110	5	004190630
8	160	5	004190632
8	210	5	004190634
8	260	5	004190636
8	310	5	004190638
9	160	3	004190644
10	160	3	004190650
10	210	3	004190652
10	260	3	004190654
10	310	3	004190656
10	460	3	004190660
12	160	3	004190664
12	210	3	004190666
12	260	3	004190668
12	460	3	004190674
14	160	2	004190686
14	260	2	004190690
14	310	2	004190692
14	460	2	004190696
16	210	2	004190712
16	260	2	004190714
16	310	2	004190716
16	460	2	004190720
18	260	1	004190724
20	310	1	004190728

420A

subland twist drills with independent spirals, for screw holes, 90°, HSS, for through holes



DIN 8374

M	Ø mm	D mm	L1 mm		
3	3,4	6	9,00	1	004200003
4	4,5	8	11,00	1	004200004
5	5,5	10	13,00	1	004200005
6	6,6	11	15,00	1	004200006
8	9	15	19,00	1	004200008
10	11	18	23,00	1	004200010

420B

subland twist drills with independent spirals for screw holes, 180°, HSS, for through holes

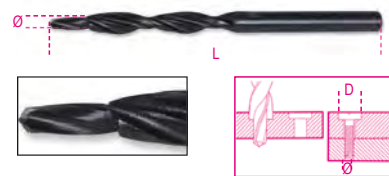

DIN 8376

M	Ø mm	D mm	L1 mm		
3	3,2	6	9,00	1	004200053
4	4,3	8	11,00	1	004200054
5	5,3	10	13,00	1	004200055
6	6,4	11,5	15,00	1	004200056
8	8,4	15	19,00	1	004200058
10	10,5	19	23,00	1	004200060

421

countersinks with guide pins, fine grade, made of HSS

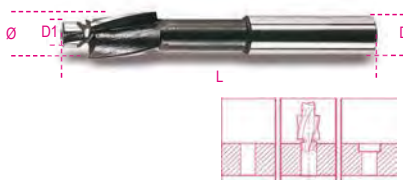

DIN 373

M	L mm	Ø mm	D1 mm	D mm		
3	71	6	3,2	5	1	004210003
4	71	8	4,3	5	1	004210004
5	80	10	5,3	8	1	004210005
6	80	11	6,4	8	1	004210006
8	100	15	8,4	12,5	1	004210008
10	100	18	10,5	12,5	1	004210010
12	100	20	13,0	12,5	1	004210012



421/SP6
M 3-4-5-6-8-10

1 004210019

421/SPV

1 004210020

422

ground centre drill bits,
60° countersink angle,
made of HSS

• For quick, safe centre holes



DIN 333/A

Ø mm	D mm	L mm		
1,60	4,0	35,5	1	004220116
2,50	6,3	45,0	1	004220125
3,15	8,0	50,0	1	004220131

423

special end mills for welding
HSS ground



Ø mm	L mm		
6	66	5	004230006
7	74	5	004230007
8	79	5	004230008
10	89	5	004230010

423A

special mills for spot welding,
HSS ground



DIN 1412/E

Ø mm	L mm		
6,5	40	1	004230015
8,0	40	1	004230020

424

conical drill bits, HSS

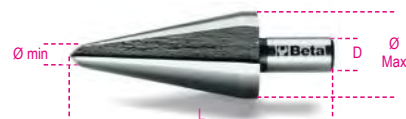

	L mm	Ø mm	D mm		
424/1	58	3÷14	6	2	004240001
424/2	63	6÷20	8	2	004240002
424/3	60	16÷30	10	2	004240003
424/4	80	3÷22	8	1	004240004
424/5	102	3÷31	10	1	004240005
424/6	86	26÷40	13	1	004240006
424/7	89	36÷50	13	1	004240007
424/8	90	40÷61	13	1	004240008



424/SP3

424/1+424/2+424/3

Ø 3÷30 mm

424/SPV

1 004240019

1 004240020

425

stepped drills, HSS



	L mm	Ø mm	S mm	D mm		
425/1	70	4÷12	1	6	2	004250010
425/2	55	4÷12	2	6	2	004250012
425/3	85	4÷20	2	10	2	004250015
425/4	85	12÷20	1	10	1	004250016
425/5	97	20÷30	1	10	1	004250017
425/6	75	4÷30	2	10	1	004250020
425/7	97	30÷40	1	13	1	004250025
425/8	100	40÷50	1	13	1	004250029



425/SP3

425/1+425/3+425/6

Ø 4÷30 mm

425/SPV

1 004250030

1 004250035

426

countersinking cutters
with three cutters,
HSS



DIN 335-C

GR	Ø mm	L mm	Ø1 mm		
1	4,3	44	4	3	004260001
2	5,3	44	4	3	004260002
3	6,3	44	5	3	004260003
4	7,3	44	6	3	004260004
5	8,3	50	6	3	004260005
6	9,4	50	6	3	004260006
7	10,4	54	6	3	004260007
8	12,4	54	8	3	004260008
9	15,0	56	10	3	004260009
10	16,5	60	10	3	004260010

GR	Ø mm	L mm	Ø1 mm		
11	20,5	63	10	3	004260011
12	25,0	66	10	3	004260012
13	28,0	71	12	3	004260013
14	31,0	71	12	3	004260014



DIN 335-C

426/SP6

GR 3-5-7-8-10-11

Ø 6,3÷20,5 mm

426/SPV

1 004260030

1 004260035

426T

countersinking cutters
with three cutters,
HSS + TiN



DIN 335-C

GR	Ø mm	L mm	Ø1 mm		
1	4,3	44	4	3	004260061
2	5,3	44	4	3	004260062
3	6,3	44	5	3	004260063
4	7,3	44	6	3	004260064
5	8,3	50	6	3	004260065
6	9,4	50	6	3	004260066
7	10,4	54	6	3	004260067
8	12,4	54	8	3	004260068
9	15,0	56	10	3	004260069
10	16,5	60	10	3	004260070
11	20,5	63	10	3	004260071
12	25,0	66	10	3	004260072
13	28,0	71	12	3	004260073
14	31,0	71	12	3	004260074



DIN 335-C

426T/SP6

GR 3-5-7-8-10-11

Ø 6,3÷20,5 mm

426/SPV

1 004260080

1 004260035

426SB

countersinking cutters, HSS



	GR	Ø mm	D mm	L mm		
426/SB1	1	2+5	6	45	1	004260101
426/SB2	2	5+10	8	48	1	004260102
426/SB3	3	10+15	10	65	1	004260103
426/SB4	4	15+20	12	85	1	004260104
426/SB5	5	20+25	15	102	1	004260105
426/SB6	6	25+30	15	115	1	004260106



426SB/SP4	1	004260130
426/SB1-426/SB2		
426/SB3-426/SB4		
Ø 2÷20 mm		
426SB/SPV1	1	004260135

426MD-3/CP3

mini rotary cutters made from hard metal

• Smooth cross cut with chip breaker



426MD-3/CT3

mini rotary cutters made from hard metal

• Smooth cross cut with chip breaker



426MD-3/F3

mini rotary cutters made from hard metal

• Smooth cross cut with chip breaker



426MD-3/FA3

mini rotary cutters made from hard metal

• Smooth cross cut with chip breaker



426MD-3/OG3

mini rotary cutters made from hard metal

• Smooth cross cut with chip breaker



426MD-3/OV3

mini rotary cutters made from hard metal

• Smooth cross cut with chip breaker



426MD-3/S3

mini rotary cutters made from hard metal

• Smooth cross cut with chip breaker



426MD-3/T3

mini rotary cutters made from hard metal

• Smooth cross cut with chip breaker



426MD-3/TA3

mini rotary cutters made from hard metal

• Smooth cross cut with chip breaker



426MD-3/A9	1	004260349
426MD-3/OV3 - 426MD-3/CP3		
426MD-3/CT3 - 426MD-3/F3		
426MD-3/TA3 - 426MD-3/T3		
426MD-3/OG3 - 426MD-3/S3		
426MD-3/FA3		

426MD/CP

rotary files, made from hard metal

cross cut HM6

L mm	Ø mm		
50	6	1	004260532
63	8	1	004260512
63	9,5	1	004260542
69	12	1	004260522
69	16	1	004260552

426MD/CT

rotary files, made from hard metal

cross cut HM6

L mm	Ø mm		
50	6	1	004260533
63	8	1	004260513
63	9,5	1	004260543
69	12	1	004260523
69	16	1	004260553

426MD/F

rotary files, made from hard metal

cross cut HM6

L mm	Ø mm		
50	6	1	004260534
63	8	1	004260514
63	9,5	1	004260544
69	12	1	004260524
69	16	1	004260554

426MD/FA

rotary files, made from hard metal

cross cut HM6

L mm	Ø mm		
50	6	1	004260539
63	8	1	004260519
63	9,5	1	004260549
69	12	1	004260529
69	16	1	004260559

426MD/OG

rotary files, made from hard metal

cross cut HM6



L mm	Ø mm		
50	6	1	004260537
63	8	1	004260517
70	10	1	004260547
76	12	1	004260527
81	16	1	004260557



426MD/OV

rotary files, made from hard metal

cross cut HM6



L mm	Ø mm		
50	6	1	004260531
61	9,5	1	004260541
67	12	1	004260521
69	16	1	004260551

426MD/S

rotary files, made from hard metal

cross cut HM6



L mm	Ø mm		
50	6	1	004260538
51	8	1	004260518
53	9,5	1	004260548
56	12	1	004260528
59	16	1	004260558

426MD/T

rotary files, made from hard metal

cross cut HM6



L mm	Ø mm		
50	6	1	004260536
63	8	1	004260516
63	9,5	1	004260546
69	12	1	004260526
70	16	1	004260556

426MD/TA

rotary files, made from hard metal

cross cut HM6



L mm	Ø mm		
50	6	1	004260535
67	8	1	004260515
72	9,5	1	004260545
73	12	1	004260525
78	16	1	004260555

426MD/SP10	1	004260510
426MD/CP-426MD/CT-426MD/F		
426MD/T-426MD/S		
Ø 8-12 mm		

427

morse taper extractors



DIN 317

GR	L mm	A mm		
0	92	13	3	004270000
1-2	140	19	3	004270002
3	190	25	3	004270003
4	225	30	3	004270004
5-6	260	35	3	004270006

428FP

machine taps for clearance holes,
coarse pitch threads, HSS



ISO 529

M	■ mm	L mm	L1 mm		
3x0,5	2,7	56	11	10	004280003
4x0,7	3,4	63	13	10	004280004
5x0,8	4,9	70	16	10	004280005
6x1	4,9	80	19	10	004280006
8x1,25	6,2	90	22	10	004280008
10x1,5	8,0	100	24	10	004280010
12x1,75	7,0	110	29	5	004280012
14x2	9,0	110	30	5	004280014
16x2	9,0	110	30	5	004280016
18x2,5	11,0	125	34	3	004280018
20x2,5	12,0	140	34	3	004280020
22x2,5	14,5	140	34	3	004280022
24x3	14,5	160	38	3	004280024

428FC

machine taps for blind holes,
coarse pitch threads, HSS



ISO 529

M	■ mm	L mm	L1 mm		
3x0,5	2,7	56	11	10	004280103
4x0,7	3,4	63	13	10	004280104
5x0,8	4,9	70	16	10	004280105
6x1	4,9	80	19	10	004280106
8x1,25	6,2	90	22	10	004280108
10x1,5	8,0	100	24	10	004280110
12x1,75	7,0	110	29	5	004280112
14x2	9,0	110	30	5	004280114
16x2	9,0	110	30	5	004280116
18x2,5	11,0	125	34	3	004280118
20x2,5	12,0	140	34	3	004280120
22x2,5	14,5	140	34	3	004280122
24x3	14,5	160	38	3	004280124

428/C14

assortment of 14 machine taps
items 428FP + 428FC



428/C14	1	004280201
428FP M3÷12		
428FC M3÷12		
428/SPV		1 004280202

429FP

machine taps for clearance holes,
coarse pitch threads HSS-CO 5%



ISO 529

M	■ mm	L mm	L1 mm		
3x0,5	2,7	56	11	5	004290003
4x0,7	3,4	63	13	5	004290004
5x0,8	4,9	70	16	5	004290005
6x1	4,9	80	19	5	004290006
8x1,25	6,2	90	22	5	004290008
10x1,5	8,0	100	24	5	004290010
12x1,75	7,0	110	29	5	004290012
14x2	9,0	110	30	5	004290014

429FC

machine taps for blind holes,
coarse pitch threads HSS-CO 5%



ISO 529

M	■ mm	L mm	L1 mm		
3x0,5	2,7	56	11	5	004290103
4x0,7	3,4	63	13	5	004290104
5x0,8	4,9	70	16	5	004290105
6x1	4,9	80	19	5	004290106
8x1,25	6,2	90	22	5	004290108
10x1,5	8,0	100	24	5	004290110
12x1,75	7,0	110	29	5	004290112
14x2	9,0	110	30	5	004290114

429/C14

assortment of 14 machine taps
items 429FP + 429FC



429/C14	1	004290201
429FP M3÷12		
429FC M3÷12		
428/SPV	1	004280202

430

hand taps, **coarse pitch**, metric thread
made from chrome-steel



ISO 529

M	■ mm	L mm	L1 mm		
2x0,4	2,5	36	11	5	004300002
3x0,5	2,5	40	12	5	004300003
4x0,7	3,0	45	14	5	004300004
5x0,8	4,0	48	16	5	004300005
6x1	5,0	50	18	3	004300006
7x1	4,5	50	18	5	004300007
8x1,25	5,0	56	22	3	004300008
9x1,25	5,5	63	22	3	004300009
10x1,5	6,0	70	25	3	004300010
11x1,5	7,0	70	25	3	004300011
12x1,75	7,0	75	30	3	004300012
14x2	8,0	80	32	3	004300014
16x2	10,0	80	32	3	004300016
18x2,5	11,0	95	40	1	004300018
20x2,5	12,0	95	40	1	004300020
22x2,5	14,5	100	40	1	004300022
24x3	14,5	110	50	1	004300024



430/SP21	1	004300201
M 3-4-5-6-8-10-12		
430/SPV	1	004300202

430ASW

hand taps, **Whitworth** thread
made from chrome-steel



DIN 352

BSW	■ mm	L mm	L1 mm		
1/8x40	2,7	40	12	5	004300031
5/32x32	3,4	45	14	5	004300032
3/16x24	4,3	48	18	5	004300033
1/4x20	4,9	50	22	5	004300034
5/16x18	4,9	56	25	3	004300035
3/8x16	5,5	70	28	3	004300036
7/16x14	6,2	70	30	3	004300037
1/2x12	7,0	75	32	3	004300038
9/16x12	9,0	80	32	1	004300039
5/8x11	9,0	80	38	1	004300040
3/4x10	11,0	95	40	1	004300041
7/8x9	14,5	100	40	1	004300042
1"x8	16,0	110	50	1	004300043

430ASC

hand taps, **UNC** thread
made from chrome-steel

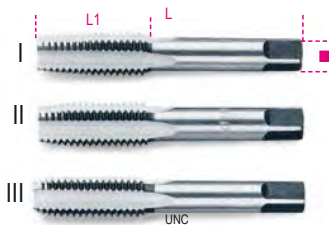

ANSI B.1

UNC	■ mm	L mm	L1 mm		
1/4x20	4,9	70	30	5	004300051
5/16x18	4,9	70	30	5	004300052
3/8x16	5,5	75	35	3	004300053
7/16x14	6,2	80	40	3	004300054
1/2x13	7,0	85	45	3	004300055
9/16x12	9,0	90	45	3	004300056
5/8x11	9,0	100	47	3	004300057
3/4x10	11,0	110	50	3	004300058
7/8x9	14,5	120	60	1	004300059
1"x8	16,0	130	60	1	004300060

431

hand taps, **coarse pitch**,
metric thread HSS



DIN 352 UNI 4535

M	■ mm	L mm	L1 mm		
3x0,5	2,5	40	12	5	004310003
4x0,7	3,0	45	14	5	004310004
5x0,8	4,0	48	16	5	004310005
6x1	5,0	50	18	5	004310006
7x1	5,0	50	18	5	004310007
8x1,25	5,0	56	22	3	004310008
10x1,5	6,0	70	25	3	004310010
12x1,75	7,0	75	30	3	004310012
14x2	9,0	80	32	1	004310014
16x2	9,0	80	32	1	004310016
18x2,5	11,0	95	40	1	004310018
20x2,5	12,0	95	40	1	004310020
22x2,5	12,0	100	40	1	004310022
24x3	14,5	110	50	1	004310024



431/SP21	1	004310201
M 3-4-5-6-8-10-12		
431/SPV	1	004310202

433

hand taps, **fine pitch**, metric thread
made from chrome-steel



DIN 2181 UNI 4535

M	■ mm	L mm	L1 mm		
6x0,75	4,5	48	16	5	004330201
7x0,75	4,5	56	18	5	004330202
8x0,75	5,0	50	16	5	004330203
8x1	5,0	56	16	5	004330204
9x0,75	6,0	63	22	5	004330205
9x1	6,0	63	22	5	004330206
10x0,75	6,5	63	18	5	004330207
10x1	6,5	63	18	5	004330208
10x1,25	6,5	63	18	5	004330209
11x0,75	7,0	70	25	3	004330210
11x1	7,0	70	25	3	004330211
11x1,25	7,0	70	25	3	004330212
12x0,75	7,0	70	20	3	004330213
12x1	7,0	70	20	3	004330214
12x1,25	7,0	70	20	3	004330215
12x1,5	7,0	70	20	3	004330216
14x1	8,0	80	32	1	004330217
14x1,25	8,0	80	32	1	004330218
14x1,5	8,0	80	32	1	004330219
16x1	10,0	80	32	1	004330220
16x1,5	10,0	80	32	1	004330221

M	mm	L	L1		
18x1,5	11,0	95	40	1	004330222
18x2	11,0	80	25	1	004330223
20x1,5	14,5	80	22	1	004330224
22x1,5	14,5	80	22	1	004330225
24x1,5	14,5	80	22	1	004330226
24x2	14,5	80	22	1	004330227

433ASF

hand taps, fine pitch, UNF thread
made from chrome-steel

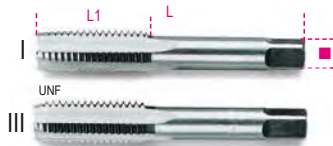

ANSI B1.1

UNF	mm	L	L1		
1/4x28	4,9	70	30	5	004330301
5/16x24	4,9	70	30	5	004330302
3/8x24	5,5	75	35	3	004330303
7/16x20	6,2	80	40	3	004330304
1/2x20	7,0	85	45	3	004330305
9/16x18	9,0	90	45	3	004330306
5/8x18	9,0	100	47	3	004330307
3/4x16	11,0	110	50	3	004330308
7/8x14	14,5	120	60	1	004330309
1"x12	16,0	130	60	1	004330310

433ASG

hand taps, cylindrical GAS (BSP) thread
made from chrome-steel



DIN 5157

GAS	mm	L	L1		
1/8x28	5,5	65	18	1	004330401
1/4x19	9,0	70	24	1	004330402
3/8x19	9,0	75	25	1	004330403
1/2x14	12,0	80	31	1	004330405
3/4x14	16,0	90	33	1	004330408
1"x11	20,0	100	39	1	004330410

434

hand taps, fine pitch, metric thread HSS



DIN 2181 UNI 4535

M	mm	L	L1		
6x0,75	4,5	48	16	5	004340001
8x0,75	5,0	56	16	5	004340003
8x1	5,0	56	16	5	004340004
10x0,75	6,5	63	18	5	004340007
10x1	6,5	63	18	5	004340008
10x1,25	6,5	63	18	5	004340009
12x1	7,0	70	20	3	004340014
12x1,25	7,0	70	20	3	004340015
12x1,5	7,0	70	20	3	004340016
13x1,5	9,0	70	20	1	004340017
14x1	9,0	70	20	1	004340018
14x1,25	9,0	70	20	1	004340019
14x1,5	9,0	70	20	1	004340020

M	mm	L	L1		
15x1,5	9,0	70	20	1	004340021
16x1	9,0	70	20	1	004340022
16x1,5	9,0	70	20	1	004340023
18x1,5	11,0	80	22	1	004340024
18x2	11,0	90	25	1	004340025
20x1,25	12,0	80	22	1	004340026
20x1,5	12,0	80	22	1	004340027
20x2	12,0	90	25	1	004340028
22x1,5	14,5	80	22	1	004340029
24x1	14,5	80	22	1	004340030
24x1,5	14,5	80	22	1	004340031
24x2	14,5	80	22	1	004340032

435

adjustable tap wrenches, steel body



DIN 1814

	mm	L		
435/0	2÷5	170	3	004350007
	M1÷M8			
435/1	2÷6	200	2	004350009
	M1÷M10			
435/1,5	2,5÷6	200	2	004350011
	M1÷M12			
435/2	3÷7	260	2	004350013
	M4÷M12			
435/3	4÷12	345	1	004350020
	M5÷M20			
435/4	5,5÷16	430	1	004350027
	M9÷M27			
435/5	7÷18	770	1	004350032
	M13÷M32			

435G

adjustable tap wrenches,
light alloy body



DIN 1814

	mm	L		
435G/0	2÷5	130	5	004350108
	M1÷M8			
435G/1	2÷6	190	5	004350110
	M1÷M10			
435G/1,5	2÷7	175	5	004350112
	M2÷M12			
435G/2	3,4÷7	280	5	004350114
	M4÷M12			
435G/3	4,9÷12	380	2	004350121
	M5÷M20			
435G/4	7÷16	500	2	004350127
	M11÷M27			
435G/5	7÷18	700	1	004350132
	M13÷M32			
435G/6	11÷24	800	1	004350142
	M18÷M42			

436

reversible ratcheting tap wrenches

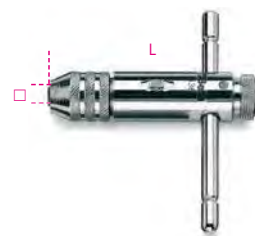

	mm	L		
436/1	2÷5	85	5	004360002
	M3÷M8			
436/2	4,6÷8	110	5	004360004
	M5÷M12			

436L

reversible ratcheting tap wrenches,
long series



	mm	L		
436L/1	2÷5	245	2	004360012
	M3÷M8			
436L/2	4,6÷8	295	2	004360014
	M5÷M12			

436R

spare clamps for items 436 and 436L

436R/1		1	004360022	
436R/2		1	004360024	

437P

thread dresser,
for repairing internal and external, right-hand
and left-hand threads

P 0.80÷3.00 mm



L	mm		
230		1	004370003

437C

set for repairing damaged spark plug threads,
M14x1.25 mm

• Helicoids height: 8.40 - 12.40 - 16.40 mm (5 pcs/size)



437C		1	004370100

437C/...

stainless steel helicoids for item 437C



H mm	
8.4	1 004370108
12.4	1 004370112
16.4	1 004370116

437C/RM14

male thread for spark plugs M14x1.25



437C/RM14	1 004370124
-----------	-------------

437K/8

tool assortment for repairing axle shaft threads

- Allows original thread to be rectified and dressed.
- Kit contents:
- Metric sizes:
20x1.25 - 20x1.5 - 22x1.00 - 22x1.5 - 24x1.5 - 24x2.00
- Inch sizes:
3/4x20 - 13/16x20



32 mm

437K/8	1 004370020
--------	-------------

200x110x30 mm

437K/9

tool assortment for repairing male and female threads, wheel fixing screws

allows original thread to be rectified and dressed

- Kit contents:
- Taps:
M12x1.25 - M12x1.5 - M12x1.75 - M14x1.5
- Dies:
M12x1.25 - M12x1.5 - M14x1.5



12 - 24 mm

437K/9	1 004370029
--------	-------------

161x123x50 mm

437K/10

assortment for repairing damaged threads on oxygen sensors M18x1.5

- Kit contents:
- 1 pilot reamer M18
- 1 tap M18x1.5
- 1 tap M20x1.5
- 5 threaded bushes M18x1.5
- 1 bushing tool



13 - 27 mm

437K/10	1 004370030
---------	-------------

190x105x40 mm

437K/12

tool assortment for repairing axle shaft threads

allows original thread to be rectified and dressed

- Kit contents:
- Metric sizes:
M16x1.0 - M16x1.5 - M20x1.0 - M20x1.5 - M22x1.5 - M24x1.5 - M24x2.0 - M27x2.0
- Inch sizes:
3/4x16 - 3/4x20 - 13/16x20 - 27/32x20



32 - 35 mm

437K/12	1 004370032
---------	-------------

220x118x52 mm

437K/16

tool assortment for repairing damaged threads on brake caliper brackets M9x1.25



437K/16	1 004370016
---------	-------------

210x150x50 mm

437K/33

tool assortment for repairing damaged spark plug threads

- Bushes:
M8x1.0 - M10x1.0 - M10x1.25 - M12x1.25
- Taps:
M8x1.0 - M10x1.0 - M10x1.25 - M12x1.0 - M12x1.25 - M14x1.25



437K/33	1 004370133
---------	-------------

210x150x50 mm

437U/09

assortment for repairing damaged threads M5-M6-M8-M10-M12



25 x M5, M6, M8, M10
10 x M12

437U/09	1 004370550
---------	-------------

M5X0,8
M6X1,0
M8X1,25
M10X1,5
M12X1,75

370x230x55 mm - 2 Kg

437U/E-M...

stainless steel helicoids



	H mm	
M5	7,5	1 004370555
M6	9	1 004370556
M8	12	1 004370558
M10	15	1 004370560
M12	18	1 004370562

437U/PM

bits and taps for item 437U/09



M5	1 004370565
M6	1 004370566
M8	1 004370568
M10	1 004370570
M12	1 004370572

438A

set of bits for drilling, threading and countersinking; HSS

- M3 - M4 - M5 - M6 - M8 - M10
- With magnetic bit holder

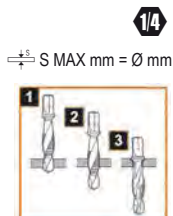

438A 1 004380010

438...

bits for drilling, threading and countersinking

HSS, 1/4" drive

1/4



M	S max mm	Hand	Part No.
M3	3	Left	2 004380103
M4	4	Left	2 004380104
M5	5	Left	2 004380105
M6	6	Left	2 004380106
M8	8	Left	2 004380108
M10	10	Left	2 004380110

440

round dies, **coarse pitch**, metric thread made from chrome-steel

R ≤ 600 N/mm²
HRC || 60+61



UNI 4535
DIN 223

M	Ø x S mm	Hand	Part No.
2x0,4	25,4 x 9	Left	5 004400002
3x0,5	25,4 x 9	Left	5 004400003
4x0,7	25,4 x 9	Left	5 004400004
5x0,8	25,4 x 9	Left	5 004400005
6x1	25,4 x 9	Left	5 004400006
7x1	25,4 x 9	Left	5 004400007
8x1,25	25,4 x 9	Left	5 004400008
9x1,25	25,4 x 9	Left	5 004400009
10x1,5	25,4 x 9	Left	5 004400010
12x1,75	25,4 x 9	Left	5 004400012

440A

round dies, **coarse pitch**, metric thread made from chrome-steel

R ≤ 600 N/mm²
HRC || 60+61



UNI 4535
DIN 223

M	Ø x S mm	Hand	Part No.
10x1,5	38,1 x 14	Left	3 004400110
11x1,5	38,1 x 14	Left	3 004400111
12x1,75	38,1 x 14	Left	3 004400112
14x2	38,1 x 14	Left	3 004400114
16x2	38,1 x 14	Left	3 004400116
18x2,5	38,1 x 14	Left	3 004400118
20x2,5	38,1 x 14	Left	3 004400120

440B

round dies, **coarse pitch**, metric thread made from chrome-steel

R ≤ 600 N/mm²
HRC || 60+61



UNI 4535
DIN 223

M	Ø x S mm	Hand	Part No.
18x2,5	50,8 x 16	Left	3 004400122
20x2,5	50,8 x 16	Left	3 004400124
22x2,5	50,8 x 16	Left	3 004400126
24x3	50,8 x 16	Left	3 004400128

440ASW

round dies, **Whitworth** thread made from chrome-steel

R ≤ 600 N/mm²



UNI EN 22568
DIN 223

BSW	Ø x S mm	Hand	Part No.
1/8x40	25,4 x 9	Left	5 004400201
5/32x32	25,4 x 9	Left	5 004400202
3/16x24	25,4 x 9	Left	5 004400203
1/4x20	25,4 x 9	Left	5 004400204
5/16x18	25,4 x 9	Left	5 004400205
3/8x16	38,1 x 14	Left	3 004400206
7/16x14	38,1 x 14	Left	3 004400207
1/2x12	38,1 x 14	Left	3 004400208
9/16x12	38,1 x 14	Left	3 004400209
5/8x11	50,8 x 16	Left	3 004400210
3/4x10	50,8 x 16	Left	3 004400211
7/8x9	50,8 x 16	Left	3 004400212
1"x8	50,8 x 16	Left	3 004400213

440ASC

round dies, **coarse pitch**, UNC thread made from chrome-steel

R ≤ 600 N/mm²



UNI EN 22568
DIN 223

UNC	Ø x S mm	Hand	Part No.
1/4x20	25,4 x 9	Left	5 004400221
5/16x18	25,4 x 9	Left	5 004400222
3/8x16	38,1 x 14	Left	3 004400223
7/16x14	38,1 x 14	Left	3 004400224
1/2x13	38,1 x 14	Left	3 004400225
9/16x12	38,1 x 14	Left	3 004400226
5/8x11	50,8 x 16	Left	3 004400227
3/4x10	50,8 x 16	Left	3 004400228
7/8x9	50,8 x 16	Left	3 004400229
1"x8	50,8 x 16	Left	3 004400230

440ASF

round dies, **fine pitch**, UNF thread made from chrome-steel

UNI EN 2258
DIN 223

UNF	Ø x S mm	Hand	Part No.
1/4x28	25,4 x 9	Left	5 004400241
5/16x24	25,4 x 9	Left	5 004400242
3/8x24	38,1 x 14	Left	3 004400243
7/16x20	38,1 x 14	Left	3 004400244
1/2x20	38,1 x 14	Left	3 004400245
9/16x18	38,1 x 14	Left	3 004400246
5/8x18	50,8 x 16	Left	3 004400247
3/4x16	50,8 x 16	Left	3 004400248
7/8x14	50,8 x 16	Left	3 004400249
1"x12	50,8 x 16	Left	3 004400250

440ASG

round dies, cylindrical **GAS** (BSP) thread made from chrome-steel

R ≤ 600 N/mm²



UNI EN 24231
DIN 223

GAS	Ø x S mm	Hand	Part No.
1/8x28	38,1 x 14	Left	3 004400255
1/4x19	38,1 x 14	Left	3 004400256
3/8x19	38,1 x 14	Left	3 004400257
1/2x14	50,8 x 16	Left	3 004400259
3/4x14	50,8 x 16	Left	3 004400260
1"x11	63,5 x 19	Left	3 004400261

441

round dies, **fine pitch**, metric thread
made from chrome-steel

R ≤ 600 N/mm²
HRC || 60÷61



UNI 4535
DIN 223

M	Ø x S mm		
6x0,75	25,4 x 9	5	004410004
7x0,75	25,4 x 9	5	004410005
8x0,75	25,4 x 9	5	004410006
8x1	25,4 x 9	5	004410007
9x0,75	25,4 x 9	5	004410008
9x1	25,4 x 9	5	004410009

441A

round dies, **fine pitch**, metric thread
made from chrome-steel

R ≤ 600 N/mm²
HRC || 60÷61



UNI 4535
DIN 223

M	Ø x S mm		
10x0,75	38,1 x 14	3	004410100
10x1	38,1 x 14	3	004410101
10x1,25	38,1 x 14	3	004410102
11x0,75	38,1 x 14	3	004410103
11x1	38,1 x 14	3	004410104
11x1,25	38,1 x 14	3	004410105
12x0,75	38,1 x 14	3	004410106
12x1	38,1 x 14	3	004410107
12x1,25	38,1 x 14	3	004410108
12x1,5	38,1 x 14	3	004410109
14x1	38,1 x 14	3	004410110
14x1,25	38,1 x 14	3	004410111
14x1,5	38,1 x 14	3	004410112
16x1	38,1 x 14	3	004410113
16x1,5	38,1 x 14	3	004410114
18x1,5	38,1 x 14	3	004410115

441B

round dies, **fine pitch**, metric thread
made from chrome-steel

R ≤ 600 N/mm²
HRC || 60÷61



UNI 4535
DIN 223

M	Ø x S mm		
18x1,5	50,8 x 16	3	004410117
18x2	50,8 x 16	3	004410118
20x1,5	50,8 x 16	3	004410119
22x1,5	50,8 x 16	3	004410120
24x1,5	50,8 x 16	3	004410121
24x2	50,8 x 16	3	004410122

442

round dies, **coarse pitch**, metric thread HSS

HRC || 62÷63
AISI M2



UNI EN 22568
DIN 223

M	Ø x S mm		
3x0,5	20x5	3	004420003
4x0,7	20x5	3	004420004
5x0,8	20x7	3	004420005
6x1	20x7	3	004420006
7x1	25x9	3	004420007
8x1,25	25x9	3	004420008
10x1,5	30x11	3	004420010
12x1,75	38x14	3	004420012
14x2	38x14	1	004420014
16x2	45x18	1	004420016
18x2,5	45x18	1	004420018
20x2,5	45x18	1	004420020
22x2,5	55x22	1	004420022
24x3	55x22	1	004420024

443

round dies, **fine pitch**, metric thread HSS

HRC || 62÷63
AISI M2



UNI EN 22568
DIN 223

M	Ø x S mm		
6x0,75	20x7	1	004430107
8x0,75	25x9	1	004430110
8x1	25x9	1	004430111
10x0,75	30x11	1	004430113
10x1	30x11	1	004430114
10x1,25	30x11	1	004430115
12x1	38x10	1	004430116
12x1,25	38x10	1	004430117
12x1,5	38x10	1	004430118
13x1,5	38x10	1	004430119
14x1	38x10	1	004430120
14x1,25	38x10	1	004430121
14x1,5	38x10	1	004430122
15x1,5	38x10	1	004430123
16x1	45x14	1	004430124
16x1,5	45x14	1	004430125
18x1,5	45x14	1	004430127
20x1,25	45x14	1	004430129
20x1,5	45x14	1	004430130
20x2	45x14	1	004430131
22x1,5	55x16	1	004430132
24x1	55x16	1	004430133
24x1,5	55x16	1	004430135
24x2	55x16	1	004430136

444

die stocks, steel body



EN 22568
DIN 225

	Ø mm	L mm		
444	20x5	190	5	004440005
444/0	20x7	190	5	004440007
444/1	25,4x9,5	210	5	004440025
444/1A	25x9	215	5	004440027
444/1B	30x11	250	5	004440030
444/C	38x10	310	3	004440033
444/1C	38x14	310	3	004440035
444/2	38,1x12,7	300	3	004440038
444/1D	45x14	445	1	004440045
444/2D	45x18	445	1	004440046
444/3	50,8x15,9	520	1	004440050
444/4	55x16	495	1	004440055
444/5A	63,5x19	520	1	004440057

444G

die stocks, light alloy body



UNI EN 22568
DIN 225

	Ø mm	L mm		
444G/A	16x5	160	5	004440103
444G	20x5	185	5	004440105
444G/0	20x7	185	5	004440107
444G/1	25,4x9,5	215	5	004440125
444G/1A	25x9	215	5	004440127
444G/1B	30x11	265	5	004440130
444G/C	38x10	315	3	004440133
444G/1C	38x14	315	3	004440135
444G/2	38,1x12,6	310	3	004440138
444G/1D	45x14	450	1	004440145
444G/2D	45x18	450	1	004440146
444G/3	50,8x16	485	1	004440150
444G/4	55x16	560	1	004440155
444G/5A	63,5x19	630	1	004440163
444G/6	65x18	630	1	004440165



446/C30

assortment of chrome-steel taps and dies, metric thread, and accessories in wooden case



446/C30 1 004460055

325x220x35 mm - 3,2 Kg

430 M mm	440 M mm	435/1,5	444/1
3x0,5	3x0,5		
4x0,7	4x0,7		
5x0,8	5x0,8		
6x1	6x1		
8x1,25	8x1,25		
10x1,5	10x1,5		
12x1,75	12x1,75		

446/C48

assortment of chrome-steel taps and dies, metric thread, and accessories in wooden case



446/C48 1 004460057

580x300x50 mm - 5 Kg

430 M mm	440 M mm	440A M mm	435/1	444/1
3x0,5	3x0,5	10x1,5	435/1	444/1
4x0,7	4x0,7	12x1,75	435/3	444/2
5x0,8	5x0,8	14x2		
6x1	6x1	16x2		
8x1,25	8x1,25	18x2,5		
10x1,5		20x2,5		
12x1,75				
14x2				
16x2				
18x2,5				
20x2,5				

446/C110

assortment of chrome-steel taps and dies, metric thread, and accessories for car repair jobs in wooden case



446/C110 1 004460060

500x337x60 mm - 8,1 Kg

430 M mm	433 M mm	440/440A M mm	441/441A M mm
2x0,4	6x0,75	2x0,4	6x0,75
3x0,5	7x0,75	3x0,5	7x0,75
4x0,7	8x0,75	4x0,7	8x0,75
5x0,8	8x1	5x0,8	8x1
6x1	9x0,75	6x1	9x0,75
7x1	9x1	7x1	9x1
8x1,25	10x0,75	8x1,25	10x0,75
9x1,25	10x1	9x1,25	10x1
10x1,5	10x1,25	10x1,5	10x1,25
11x1,5	11x0,75	11x1,5	11x0,75
12x1,75	11x1	12x1,75	11x1
14x2	11x1,25	14x2	11x1,25
16x2	12x0,75	16x2	12x0,75
	12x1		12x1
	12x1,25		12x1,25
	12x1,5		12x1,5
	14x1		14x1
	14x1,25		14x1,25
	14x1,5		14x1,5
	16x1		16x1
	16x1,5		16x1,5
	18x1,5		18x1,5

435/0	444/1	436/1
435/3	444/2	

446ASF/C29

assortment of chrome-steel taps and dies, UNF thread, and accessories in wooden case



446ASF/C29 1 004460070

660x410x50 mm - 6 Kg

433ASF	440ASF	435/1,5	444/1
1/4	1/4	435/1,5	444/1
5/16	5/16	435/3	444/2
3/8	3/8		444/3
7/16	7/16		
1/2	1/2		
9/16	9/16		
5/8	5/8		
3/4	3/4		

446ASW/C36

assortment of chrome-steel taps and dies, Whitworth thread, and accessories in wooden case



446ASW/C36 1 004460075

525x310x50 mm - 3,4 Kg

430ASW	440ASW	435/1,5	444/1
1/8	1/8	435/1,5	444/1
5/32	5/32	435/2	444/2
3/16	3/16		
1/4	1/4		
5/16	5/16		
3/8	3/8		
7/16	7/16		
1/2	1/2		



446ASC/C37

assortment of chrome-steel taps and dies, **UNC** thread, and accessories in wooden case



446ASC/C37

660x410x50 mm - 6,7 Kg

1 004460080

430ASC	440ASC		
1/4	1/4	435/1,5	444/1
5/16	5/16	435/3	444/2
3/8	3/8		444/3
7/16	7/16		
1/2	1/2		
9/16	9/16		
5/8	5/8		
3/4	3/4		

446ASG/C23

assortment of chrome-steel taps and dies, cylindrical **GAS** thread, and accessories in wooden case



446ASG/C23

700x430x70 mm - 9,8 Kg

1 004460085

433ASG	440ASG		
1/8	1/8	435/3	444/2
1/4	1/4	435/5	444/3
3/8	3/8		444/5A
1/2	1/2		
3/4	3/4		
1"	1"		

447/C37

assortment of HSS taps and dies, metric thread, and accessories in metal case



447/C37

380x185x35 mm - 3,9 Kg

1 004470055

431 M mm	442 M mm		
3x0,5	3x0,5	435/0	444
4x0,7	4x0,7	435/2	444/0
5x0,8	5x0,8		444/1A
6x1	6x1		444/1B
8x1,25	8x1,25		444/1C
10x1,5	10x1,5		
12x1,75	12x1,75		

436/1	0,5x3x75
-------	----------

447/C53

assortment of HSS taps and dies, metric thread, and accessories in metal case



447/C53

500x235x50 mm - 9 Kg

1 004470060

431 M mm	442 M mm			
3x0,5	3x0,5	435/1,5	444	436/1
4x0,7	4x0,7	435/3	444/0	436/2
5x0,8	5x0,8		444/1A	
6x1	6x1		444/1B	
8x1,25	8x1,25		444/1C	
10x1,5	10x1,5		444/2D	
12x1,75	12x1,75			
14x2	14x2			
16x2	16x2			
18x2,5	18x2,5			
20x2,5	20x2,5			

447/C70

assortment of HSS taps and dies, metric thread, and accessories for car repair jobs industrial maintenance in wooden case



447/C70

510x340x70 mm - 7,5 Kg

1 004470065

431 M mm	434 M mm	442 M mm	443 M mm
3x0,5	8x1	3x0,5	8x1
4x0,7	10x1,25	4x0,7	10x1,25
5x0,8	12x1,25	5x0,8	12x1,25
6x1	12x1,5	6x1	12x1,5
7x1	14x1,25	7x1	14x1,25
8x1,25	14x1,5	8x1,25	14x1,5
10x1,5	16x1,5	10x1,5	16x1,5
12x1,75		12x1,75	
14x2		14x2	
16x2		16x2	

435/0	444	436/1
435/3	444/0	
	444/1A	
	444/1B	
	444/C	
	444/1C	
	444/1D	
	444/2D	

450

holesaws HSS, Bimetal



HSS-Co 8%

Ø mm	Ø "	A mm	
16	(5/8)	57	1 004500016
17	(11/16)	57	1 004500017
19	(3/4)	51	1 004500019
20	-	51	1 004500020
21	(13/16)	51	1 004500021
22	(7/8)	51	1 004500022
24	(15/16)	51	1 004500024
25	(1")	51	1 004500025
27	(1"1/16)	51	1 004500027
29	(1"1/8)	51	1 004500029
30	(1"3/16)	51	1 004500030
32	(1"1/4)	51	1 004500032
33	(1"5/16)	51	1 004500033
35	(1"3/8)	51	1 004500035

Ø mm	Ø "	A mm		
37	(1"7/16)	51	1	004500037
38	(1"1/2)	44	1	004500038
40	(1"9/16)	44	1	004500040
41	(1"5/8)	44	1	004500041
43	(1"11/16)	44	1	004500043
44	(1"3/4)	44	1	004500044
46	(1"13/16)	44	1	004500046
48	(1"7/8)	44	1	004500048
51	(2")	44	1	004500051
52	(2"1/16)	44	1	004500052
54	(2"1/8)	44	1	004500054
57	(2"1/4)	44	1	004500057
59	(2"5/16)	44	1	004500059
60	(2"3/8)	44	1	004500060
64	(2"1/2)	44	1	004500064
65	(2"9/16)	44	1	004500065
67	(2"5/8)	44	1	004500067
68	-	44	1	004500068
70	(2"3/4)	44	1	004500070
73	(2"7/8)	44	1	004500073
76	(3")	44	1	004500076
79	(3"1/8)	44	1	004500079
83	(3"1/4)	44	1	004500083
86	(3"3/8)	44	1	004500086
89	(3"1/2)	44	1	004500089
92	(3"5/8)	44	1	004500092
95	(3"3/4)	44	1	004500095
98	(3"7/8)	44	1	004500098
102	(4")	44	1	004500102
105	(4"1/8)	44	1	004500105
108	(4"1/4)	44	1	004500108
111	(4"3/8)	44	1	004500111
114	(4"1/2)	44	1	004500114
121	(4"3/4)	44	1	004500121
127	(5")	44	1	004500127
140	(5"1/2)	44	1	004500140
152	(6")	44	1	004500152

450AL

arbors for holesaws

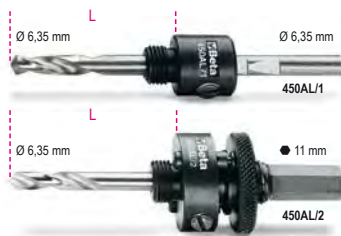

	Ø mm	L mm		
450AL/1	16÷30	54	1	004500210
450AL/2	32÷152	70	1	004500215

450AD

adaptors for arbors item 450AL/1



	Ø mm			
450AD	32÷51	1	004500230	

450PA/1

pilot drills for arbors item 450AL/1, HSS



ØxL mm			
6,35x105	1	004500252	

450PA/2

pilot drills for arbors item 450AL/2, HSS

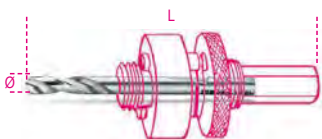

ØxL mm			
6,35x80	1	004500253	

450PR

extension for holesaws



L mm			
305	1	004500255	

450/C9

assortment of holesaws and accessories for electricians



HSS-Co 8%

450/C9	1	004500305	

450	Ø 22 - 29 - 35 - 44 - 51 - 64 mm
450AL	/1 - /2
450AD	
	220x160x60 mm - 1,6 Kg

450/C13

assortment of holesaws and accessories for installers



HSS-Co 8%

450/C13	1	004500310	

450	Ø 19 - 22 - 29 - 35 - 38 44 - 51 - 57 - 64 mm
450AL	/1 - /2
450PA/1	
450AD	
	215x180x65 mm - 1,8 Kg

450/C15

assortment of holesaws and accessories for electricians



450/C15	1	004500313	

450	Ø 16 - 20 - 25 - 32 - 40 51 - 60 - 65 - 70 mm
450AL	/1 - /2
450PA	/1 - /2
450PR	
450AD	
	420x185x60 mm - 3,2 Kg

450/C21

assortment of holesaws and accessories
for industrial use



HSS-Co 8%

450/C21 1 004500315

450	Ø 19 - 22 - 29 - 35 - 38 44 - 51 - 57 - 64 - 76 83 - 92 - 95 - 105 - 114 mm
450AL	/1 - /2
450PA	/1 - /2
450PR	
450AD	
	420x280x60 mm - 7 Kg

451

hole cutters HSS, entirely ground

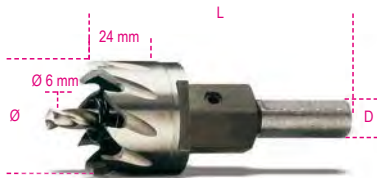

Ø mm	L mm	D mm	
12	85	8	1 004510012
13	85	8	1 004510013
14	85	8	1 004510014
15	85	10	1 004510015
16	85	10	1 004510016
17	85	10	1 004510017
18	85	10	1 004510018
19	85	10	1 004510019
20	85	10	1 004510020
21	85	10	1 004510021
22	85	10	1 004510022
23	85	10	1 004510023
24	85	10	1 004510024
25	85	10	1 004510025
26	90	10	1 004510026
27	90	10	1 004510027
28	90	10	1 004510028
29	90	10	1 004510029
30	90	10	1 004510030
31	90	10	1 004510031
32	90	10	1 004510032
33	90	10	1 004510033
34	90	10	1 004510034
35	90	10	1 004510035
36	85	10	1 004510036
37	85	10	1 004510037
38	85	10	1 004510038
39	85	10	1 004510039
40	85	10	1 004510040
41	85	10	1 004510041
42	85	10	1 004510042
43	85	10	1 004510043
44	85	10	1 004510044
45	85	10	1 004510045
46	85	10	1 004510046
47	85	10	1 004510047
48	85	10	1 004510048
49	85	10	1 004510049
50	85	10	1 004510050

451GA

arbors for hole cutters item 451



M	Ø mm	L mm	D mm	
10x1,25	12÷14	57	8	1 004510101
12x1,25	15÷34	57	10	1 004510102
14x1,5	35÷50	57	10	1 004510105

451PA

pilot drill for hole cutters item 451
HSS



Ø mm	L mm	
6	53	1 004510103

451PR

extension for hole cutters item 451



M	Ø mm	L mm	Ø1 mm	
12x1,25	15÷34	400	13	1 004510104
14x1,5	35÷50	400	13	1 004510108

452

hole cutters with hard metal insets

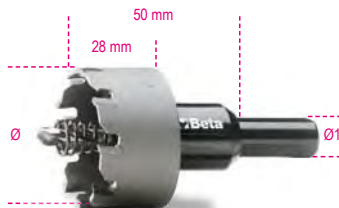

Ø mm	Ø1 mm	
15	10	1 004520015
16	10	1 004520016
17	10	1 004520017
18	10	1 004520018
19	10	1 004520019
20	10	1 004520020
21	10	1 004520021
22	10	1 004520022
23	10	1 004520023
24	10	1 004520024
25	10	1 004520025
26	10	1 004520026
27	10	1 004520027
28	10	1 004520028
29	10	1 004520029
30	10	1 004520030
31	10	1 004520031
32	10	1 004520032
33	10	1 004520033
34	10	1 004520034
35	10	1 004520035
36	10	1 004520036
37	10	1 004520037
38	10	1 004520038
39	13	1 004520039
40	13	1 004520040

Ø mm	Ø1 mm	
41	13	1 004520041
42	13	1 004520042
43	13	1 004520043
44	13	1 004520044
45	13	1 004520045
46	13	1 004520046
47	13	1 004520047
48	13	1 004520048
49	13	1 004520049
50	13	1 004520050
55	13	1 004520055
60	13	1 004520060
65	13	1 004520065
70	13	1 004520070
75	13	1 004520075
80	13	1 004520080
85	13	1 004520085
90	13	1 004520090

452GA

arbors for hole cutters item 452



	Ø mm	
452GA/1	15÷21	1 004520125
452GA/2	22÷38	1 004520126
452GA/3	39÷100	1 004520127

460

hole cutters for building materials

- For concrete, cement, natural and artificial stones
- Maximum drilling depth: 60 mm

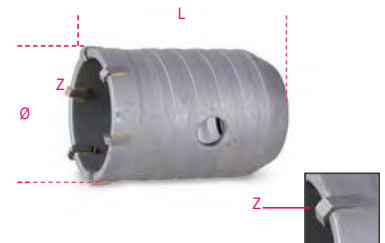

Ø mm	L mm	Z	
50	75	6	1 004600050
60	75	6	1 004600060
65	75	6	1 004600065
80	75	6	1 004600080
90	75	6	1 004600090
100	75	8	1 004600100
112	75	8	1 004600112
125	80	10	1 004600125
150	80	12	1 004600150

460PP

pilot drill for hole cutters for building materials
460



Ø mm	L mm	
8	120	1 004600201

460G

shanks for hole cutters 460



L mm		
220	1	004600222
370	1	004600237
460	1	004600246

560/C3

torque multiplier for right-hand and left-hand tightening, in plastic case, ratio 3.8:1, with anti-wind up system

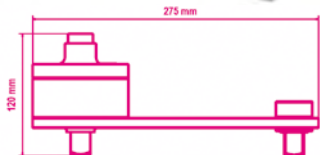

Nm	Kgfm	lbf.ft	□	■	kg
1500	150	1110	1/2"	3/4"	3,9

560/C3 1 005600030

560/C3PLUS

torque multiplier for right-hand and left-hand tightening, in plastic case, ratio 3.8:1, with anti-wind up system

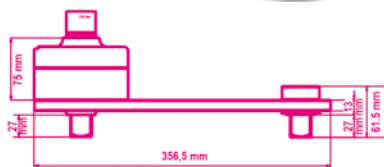

Nm	Kgfm	lbf.ft	□	■	kg
2700	270	1991	3/4"	1"	7,5

560/C3PLUS 1 005600038

560/C2

torque multiplier for right-hand and left-hand tightening, and accessories, ratio 5:1, in plastic case

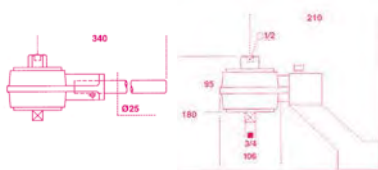

Nm	Kgfm	lbf.ft	□	■	kg
1300	130	960	1/2"	3/4"	3,8

560/C2	1	005600020
560/2	1	005600002
560/18	1	005600018
560/19	1	005600019
560/22	1	005600022

310x275x120 mm

560/C4+

torque multiplier for right-hand and left-hand tightening, and accessories, ratio 5:1, with reaction foot

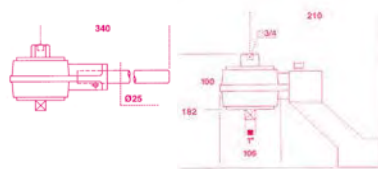
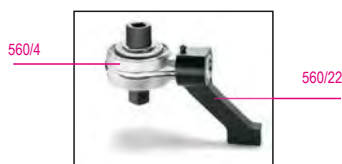

Nm	Kgfm	lbf.ft	□	■	kg
2700	270	2000	3/4"	1"	5

560/C4PLUS	1	005600042
560/4	1	005600004
560/18	1	005600018
560/22	1	005600022

310x275x120 mm

560/C6

torque multipliers for right-hand and left-hand tightening in plastic case ratio: 6.5:1



Nm	Kgfm	lbf.ft	□	■	kg
1500	150	1106	1/2"	3/4"	6

560/C6 1 005600160
400x260x110 mm

560/C12

torque multipliers for right-hand and left-hand tightening in plastic case ratio: 12:1



Nm	Kgfm	lbf.ft	□	■	kg
2500	250	1844	1/2"	1"	7

560/C12 1 005600210
400x260x110 mm

561/1

torque multiplier for right-hand and left-hand tightening, ratio 5:1, with two reaction feet

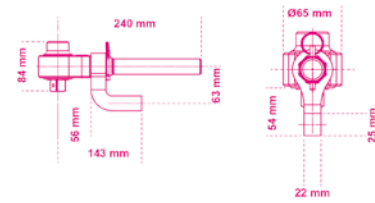

Nm	Kgfm	lbf.ft	□	■	kg
1000	100	740	1/2"	3/4"	2,7

561/1 1 005610010
270x210x70 mm

562/1 - 562/2

torque multipliers for right-hand and left-hand tightening, ratio 5:1,



Nm	Kgfm	lbf.ft	□	■	D	A	L min	L max	kg
1700	170	1250	3/4	1"	108	95	85	220	5,3

562/1 1 005620001

Nm	Kgfm	lbf.ft	□	■	D	A	L min	L max	kg
3400	340	2500	3/4	1"	119	115	85	265	7,0

562/2 1 005620002

564/3R - 564/4R

torque multipliers for right-hand and left-hand tightening, ratio 25:1, with anti-wind up system



Nm	Kgfm	lbf.ft	□	■	D	A	L	kg
3000	300	2200	1/2	1"	108	188	155	9,2

564/3R 1 005640003

Nm	Kgfm	lbf.ft	□	■	D	A	L	kg
6000	600	4500	1/2	1 1/2"	119	235	200	15,5

564/4R 1 005640004

565/1R - 565/2R - 565/3R

torque multipliers for right-hand and left-hand tightening, ratio, 25:1, with anti-wind up system



Nm	Kgfm	lbf.ft	□	■	D	A	L min	L max	kg
1700	170	1250	1/2	1"	108	125	80	215	7,7

565/1R 1 005650011

Nm	Kgfm	lbf.ft	□	■	D	A	L min	L max	kg
3400	340	2500	1/2	1"	119	145	85	265	10,1

565/2R 1 005650012

Nm	Kgfm	lbf.ft	□	■	D	A	L min	L max	kg
3400	340	2500	1/2	1 1/2"	119	145	85	265	10,7

565/3R 1 005650013

565/4R

torque multiplier for right-hand and left-hand tightening, ratio 25:1, with anti-wind up system

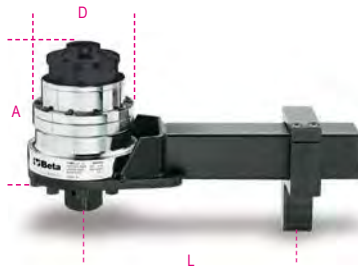

Nm	Kgfm	lbf.ft	□	■	D	A	L min	L max	kg
6000	600	4500	1/2	1 1/2"	144	180	125	335	17

565/4R 1 005650014

565/5R

torque multiplier for right-hand and left-hand tightening, ratio 25:1, with anti-wind up system

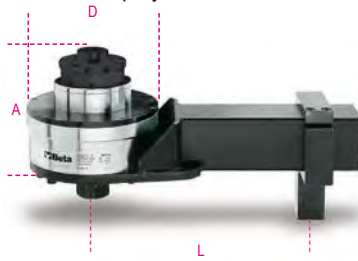

Nm	Kgfm	lbf.ft	□	■	D	A	L min	L max	kg
9500	950	7000	1/2	1 1/2"	184	180	155	355	25

565/5R 1 005650015

567/4R

torque multiplier for right-hand and left-hand tightening, ratio 125:1, with anti-wind up system



Nm	Kgfm	lbf.ft	□	■	D	A	L min	L max	kg
6000	600	4500	1/2	1 1/2"	144	210	125	335	19

567/4R 1 005670014

567/5R

torque multiplier for right-hand and left-hand tightening, ratio 125:1, with anti-wind up system

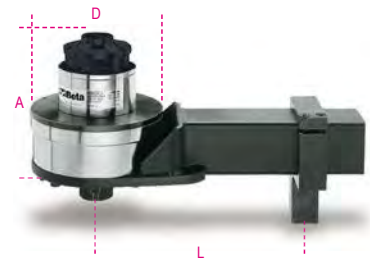

Nm	Kgfm	lbf.ft	□	■	D	A	L min	L max	kg
9500	950	7000	1/2	1 1/2"	184	210	155	350	27

567/5R 1 005670015

562VV-A

multiplier case, made of hard-wearing polypropylene with sponge lining
Interior dimensions: 380x270x180 mm



562VV-A 1 005620501

562/1-562/2-564/3R
564/4R-565/1R-565/2R
565/3R

410x340x205 mm - 3,5 kg

565VV-B

multiplier case, made of hard-wearing polypropylene with sponge lining
Interior dimensions: 480x370x205 mm



565VV-B 1 005650502

565/4R-565/5R
567/4R-567/5R

520x435x230 mm - 5,4 kg



581
slip-torque screwdriver, ungraduated
for right-hand tightening
torque accuracy: $\pm 6\%$
(to be used with items 588 - 682)



UNI EN ISO 6789

Nm	gfm	lbf.in	kg
1,2÷6	120÷600	1/4"	275

581 1 005810001

583
slip-torque screwdriver, graduated
for right-hand tightening
torque accuracy: $\pm 6\%$



UNI EN ISO 6789

Nm	gfm	lbf.in	kg
0,3÷1,5	30÷150	1/4"	240

583/1,5 1 005830015

Nm	gfm	lbf.in	kg
0,6÷3	60÷300	1/4"	240

583/3 1 005830030

Nm	gfm	lbf.in	kg
1,2÷6	120÷600	1/4"	350

583/6 1 005830060

583/C31

1 torque screwdriver, 8 hexagon hand sockets,
20 bits and 2 accessories

1/4



583/C31 1 005830931

	583/6	1.2 - 6 Nm
	900	4-5,5-6-7-8-9-10 mm
	860LP	0,6x4,5 - 1x5,5 - 1,2x6,5 mm
	860PH	PH1 - PH2 (x2) - PH3
	860PE	2-2,5-3-4-5 mm
	860TX	T9-T10-T15-T20-T25-T27-T30-T40
	882P/80	80 mm
	892/0	● 1/4 ■ 1/4

270x120x45 mm - 1,2 kg

588

electronic digital torque meter

For testing and setting torque screwdrivers 581-583
Reading accuracy: $\pm 1\%$ of read value

CE



Nm	lbf.in	kg
1÷10	10÷90	1/4"
		1,8

588 1 005880001

Table of fields of use
for torque wrenches and bars
at end of price list



590 - 592

direct reading torque wrenches
for right-hand and left-hand tightening
torque accuracy: $\pm 4\%$



UNI EN ISO 6789

Nm	Kgfm	lbf.in	lbf.ft	A mm	L mm	kg
0,3÷4	0,03÷0,4	3÷35	1/4	60	253	0,52

590 1 005900001

Nm	Kgfm	lbf.in	lbf.ft	A mm	L mm	kg
0,5÷13,5	0,05÷1,35	4÷120	1/4	60	253	0,52

590/1 1 005900003

Nm	Kgfm	lbf.in	lbf.ft	A mm	L mm	kg
1÷27	0,1÷2,7	10÷240	3/8	70	253	0,52

592/3 1 005920005

Nm	Kgfm	lbf.in	lbf.ft	A mm	L mm	kg
3÷40	0,3÷4	20÷360	3/8	70	253	0,52

592/4 1 005920007

594

direct reading torque wrenches
for right-hand and left-hand tightening
torque accuracy: $\pm 4\%$

12"



UNI EN ISO 6789

Nm	Kgfm	lbf.ft	lbf.in	A mm	L mm	kg
6÷80	0,6÷8	5÷60	1/2	85	455	1,35

594/8 1 005940011

Nm	Kgfm	lbf.ft	lbf.in	A mm	L mm	kg
20÷215	2÷21,5	15÷160	1/2	85	530	1,40

594/21 1 005940015

Torque calibration
service
at end of price list

596 - 598

direct reading torque wrenches
for right-hand and left-hand tightening
torque accuracy: $\pm 4\%$

A signal light and an intermittent sound mean the pre-set torque load is achieved.



UNI EN ISO 6789

Nm	Kgfm	lbf.ft	■	A mm	L mm	kg
80÷400	8÷40	60÷300	3/4"	111	710	3,2

596/40SL 1 005960010

Nm	Kgfm	lbf.ft	■	A mm	L mm	kg
160÷800	16÷80	120÷600	3/4"	115	1025	4,85

Nm	Kgfm	lbf.ft	■	A mm	L mm	kg
200÷2000	20÷200	150÷1500	1"	135	1930	16,70

598/200SL 1 005980022

599DGT

electronic torque wrench
with reversible ratchet,
right-hand (accuracy: $\pm 2\%$) and left-hand
(accuracy: $\pm 3\%$) tightening

- Dual measurement mode: peak hold and track
- Light indicators and an intermittent sound inform user that preset torque has been reached
- Power supply: 2 1.5V batteries (included)



UNI EN ISO 6789

Nm	Kgfm	lbf.ft	■	D mm	A mm	L mm	kg
12÷60	1,2÷6	8÷44	3/8	30	33	413	0,9

Nm	Kgfm	lbf.ft	■	D mm	A mm	L mm	kg
20÷100	2÷10	15÷80	1/2	30	37	413	0,9

599DGT/10X 1 005990010

Nm	Kgfm	lbf.ft	■	D mm	A mm	L mm	kg
40÷200	4÷20	30÷150	1/2	40	43	520	1,3

599DGT/20 1 005990020

Nm	Kgfm	lbf.ft	■	D mm	A mm	L mm	kg
40÷200	4÷20	30÷150	1/2	40	43	520	2

Nm	Kgfm	lbf.ft	■	D mm	A mm	L mm	kg
68÷340	6,8÷34	58÷280	1/2	40	43	640	2,35

599DGT/30 1 005990030

599DGT-AN

electronic torque wrench, torque and angle
readout,
with reversible ratchet,
right-hand (accuracy: $\pm 2\%$)
and left-hand (accuracy: $\pm 3\%$) tightening

- tightening types: torque, angle, torque + angle
- dual measurement mode: peak hold and track
- light indicators and an intermittent sound inform user that preset torque or angle has been reached
- tightening data storage (up to 250 values)
- up to 9 torque/angle values can be preset
- key safety lockout
- wrench can be associated with 16 users through user ID
- tightening data traceability. Software allows date and time, tool serial number, set tightening value and reached value to be stored and associated with user ID
- nonslip bi-material handle
- included: 2 AA - 1.5V batteries, USB cable and software



UNI EN 26789
ISO 6789

Nm	Kgfm	lbf.ft	■	D mm	A mm	L mm	kg
20÷100	2÷10	15÷80	1/2	30	33	413	0,9

Nm	Kgfm	lbf.ft	■	D mm	A mm	L mm	kg
40÷200	4÷20	30÷150	1/2	40	43	520	1,3

599DGT-AN/20 1 005990620

Nm	Kgfm	lbf.ft	■	D mm	A mm	L mm	kg
40÷200	4÷20	30÷150	1/2	40	43	520	1,3

599DGT-AN/20 1 005990620

Torque calibration
service
at end of price list

600

torque angle indicators

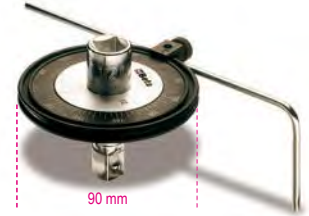

	□	■		
600/1	1/2	1/2	1	006000001
600/2	3/4	3/4	1	006000002

601C

digital tangle indicator

Light signals and an intermittent sound inform user that preset angle has been reached



601C	85x80x87 mm	70 g	1 006010100

601CA

digital torque and angle indicator

light indicators and an intermittent sound
inform user that preset torque or angle
has been reached



	□	■	Nm	
601CA	1/2"	1/2"	10÷200	1 006010120

120x90x120 mm - 240 g

603

calibrated slipping torque wrenches
for right-hand tightening
torque accuracy: $\pm 6\%$



UNI EN ISO 6789

Nm	Kgfm	lbf.in	■	A	L	g
1÷5	0,1±0,5	10÷45	1/4	35	195	235

603/5	1	006030005
-------	---	-----------

Nm	Kgfm	lbf.in	■	A	L	g
2÷10	0,2±1,0	18÷90	1/4	35	195	235

603/10	1	006030010
--------	---	-----------

604B

break-back torque bars
for right-hand and left-hand tightening
torque accuracy: $\pm 6\%$



UNI EN ISO 6789

Nm	kgfm	lbf.in	∅	L	g
1÷5	0,1±0,5	10÷45	8	220	290

604B/5	1	006040015
--------	---	-----------

Nm	Kgfm	lbf.in	∅	L	g
2÷10	0,2±1,0	18÷90	8	220	300

604B/10	1	006040020
---------	---	-----------

605E

click-type torque wrenches
with reversible ratchets
for right-hand and left-hand tightening
torque accuracy: $\pm 6\%$



UNI EN ISO 6789

Nm	Kgfm	lbf.in	■	A	L	g
1÷5	0,1±0,5	10÷45	1/4	20	190	180

605E/5	1	006050105
--------	---	-----------

Nm	Kgfm	lbf.in	■	A	L	g
2÷10	0,2±1,0	18÷90	1/4	20	190	180

605E/10	1	006050110
---------	---	-----------

611

reversible ratchets
for torque bars items 604B/5 and 604B/10
8 mm drive



■	L	g
1/4	42,5	1

1	006110001
---	-----------

**Torque calibration
service
at end of price list**

612 ÷ 614

reversible ratchets for torque bars



Items 612 and 612X should not be used
with tightening torques exceeding 100 Nm

■	L	LA	g		
612	3/8	66	32	2	006120000
612X	1/2	66	32	2	006120010
614	1/2	71	32	2	006140000
614X	3/4	71	32	2	006140004

614/50

push-through ratchet for torque bars



■	L	LA <td>g</td>	g
1/2	71	32	2

2	006140002
---	-----------

**Spare parts
rotating mechanism of ratchets,
see table after item 929/C8**

615

reversible ratchets
for torque bars, rectangular drive



■	L	LA	g		
9x12	3/8	53	28,8	1	006150010
9x12	1/2	53	28,8	1	006150020
14x18	1/2	70	39,8	1	006150120

616 - 617 - 619

fixed heads for torque bars



■	L	LA	g		
616	1/4	61	32	1	006160000
617	3/8	61	32	1	006170000
619	1/2	63	32	1	006190000

621

bit holder accessories
for torque bars, rectangular drive



■	L	LA	g			
P 1/4	9x12	1/4	40	28,8	1	006210000
* P 5/16	14x18	5/16	61	32,5	1	006210110

*Caution! Recalculate torque value to set as shown in
table at end of price list

641

open jaw wrenches
for torque bars 604B/5 and 604B/10
8 mm drive



■	L	g
4	37	1
5	37	1
5,5	37	1
6	37	1
7	37	1
8	42	1
9	42	1
10	42	1

642

open jaw wrenches for torque bars



mm	L mm	LA mm	A mm		
8	54	32	22	1	006420008
10	57	32	26	1	006420010
12	58	32	30	1	006420012
13	58	32	30	1	006420013
14	59	32	32	1	006420014
15	59	32	35	1	006420015
16	59	32	38	1	006420016
17	60	32	39	1	006420017
18	61	32	42	1	006420018
19	61	32	43	1	006420019
20	61	32	50	1	006420020
21	62	32	53	1	006420021
22	62	32	53	1	006420022
23	65	32	53	1	006420023
24	63	32	53	1	006420024
26	64	32	59	1	006420026
27	65	32	59	1	006420027
28	66	32	64	1	006420028
30	66	32	66	1	006420030
32	67	32	66	1	006420032
*36	76	42	80	1	006420036
*40	77	52	95	1	006420040
*41	78	52	95	1	006420041
*46	90	52	95	1	006420046

*Caution! Recalculate torque value to set as shown in table at end of price list

643

open jaw wrenches for torque bars, rectangular drive



mm	mm	L mm	LA mm		
7	9X12	37	28,8	1	006430007
8	9x12	37	28,8	1	006430008
10	9x12	39	28,8	1	006430010
12	9x12	39	28,8	1	006430012
13	9x12	39	28,8	1	006430013
14	9x12	43	28,8	1	006430014
15	9x12	43	28,8	1	006430015
16	9x12	43	28,8	1	006430016
17	9x12	43	28,8	1	006430017
*18	9x12	47	36,3	1	006430018
*19	9x12	51	36,3	1	006430019
*21	9X12	52	36,3	1	006430021
*22	9x12	52	36,3	1	006430022

*Caution! Recalculate torque value to set as shown in table at end of price list

mm	mm	L mm	LA mm		
13	14x18	60	39,8	1	006430113
14	14x18	58	39,8	1	006430114
15	14x18	60	39,8	1	006430115
16	14x18	60	39,8	1	006430116
17	14x18	60	39,8	1	006430117
18	14x18	61	39,8	1	006430118
19	14x18	61	39,8	1	006430119
21	14x18	61	39,8	1	006430121
22	14x18	62	39,8	1	006430122
24	14x18	64	39,8	1	006430124
*27	14x18	68	44,8	1	006430127
*30	14x18	77	49,8	1	006430130
*32	14x18	77	49,8	1	006430132

*Caution! Recalculate torque value to set as shown in table at end of price list

mm	mm	L mm	LA mm		
*34	14x18	80	54,8	1	006430134
*36	14x18	83	54,8	1	006430136
*38	14X18	83	54,8	1	006430138
*41	14x18	91	64,8	1	006430141

*Caution! Recalculate torque value to set as shown in table at end of price list

650A

adjustable wrenches for torque bars, rectangular drive



A min-max mm	mm	L mm	LA mm		
*5-27	9X12	93	74,3	1	006500027
*5-30	9X12	106	85,3	1	006500030
*5-30	14X18	115	89	1	006500130
*10-41	14X18	127	100	1	006500141

*Caution! Recalculate torque value to set as shown in table at end of price list

650H

hook wrenches for torque bars, rectangular drive



mm	mm	L mm	LA mm		
*28-36	14x18	122	92	1	006500928
*40-45	14x18	129	92	1	006500940
*50-55	14x18	129	92	1	006500950
*58-62	14x18	135	92	1	006500958
*68-75	14x18	139	92	1	006500968
*80-90	14x18	145	92	1	006500980

*Caution! Recalculate torque value to set as shown in table at end of price list

652

ring wrenches for torque bars



mm	L mm	LA mm		
8	58	32	1	006520008
10	58	32	1	006520010
12	58	32	1	006520012
13	58	32	1	006520013
14	58	32	1	006520014
15	62	32	1	006520015
16	63	32	1	006520016
17	64	32	1	006520017
18	65	32	1	006520018
19	65	32	1	006520019
21	67	32	1	006520021
22	68	32	1	006520022
24	69	32	1	006520024
26	71	32	1	006520026
27	71	32	1	006520027
30	73	32	1	006520030
32	74	32	1	006520032

653

ring wrenches for torque bars, rectangular drive



mm	mm	L mm	LA mm		
7	9X12	40	28,8	1	006530007
8	9x12	40	28,8	1	006530008
10	9x12	43	28,8	1	006530010
12	9x12	44	28,8	1	006530012
13	9x12	44	28,8	1	006530013
14	9x12	45	28,8	1	006530014
15	9x12	46	28,8	1	006530015
16	9x12	47	28,8	1	006530016
17	9x12	47	28,8	1	006530017
18	9x12	48	28,8	1	006530018
19	9x12	49	28,8	1	006530019
21	9X12	51	28,8	1	006530021
22	9x12	51	28,8	1	006530022

mm	mm	L mm	LA mm		
13	14x18	61	39,8	1	006530113
14	14x18	61	39,8	1	006530114
15	14x18	62	39,8	1	006530115
16	14x18	63	39,8	1	006530116
17	14x18	64	39,8	1	006530117
18	14x18	64	39,8	1	006530118
19	14x18	66	39,8	1	006530119
21	14x18	66	39,8	1	006530121
22	14x18	67	39,8	1	006530122
24	14x18	69	39,8	1	006530124
*27	14x18	76	44,8	1	006530127
*30	14x18	77	44,8	1	006530130
*32	14x18	79	44,8	1	006530132
*34	14x18	80	44,8	1	006530134
*36	14x18	80	44,8	1	006530136
*38	14X18	90	49,8	1	006530138
*41	14x18	90	49,8	1	006530141

*Caution! Recalculate torque value to set as shown in table at end of price list

659/15

adaptor with rectangular female (14x18 mm) and male (9x12 mm) drives



L mm	mm	mm	LA mm		
*56	14x18	9x12	39	1	006590815

*Caution! Recalculate torque value to set as shown in table at end of price list



Always apply torque loads evenly and progressively to avoid breakage and any possible injury.

659/16

adaptor with rectangular female (9x12 mm) and male (14x18 mm) drives



L	mm	mm	mm	LA	mm	mm	mm	mm	g
* 52	9x12	14x18	31						1 006590816

*Caution! Recalculate torque value to set as shown in table at end of price list

665

mechanical torque wrench with digital setting and reversible ratchet, for right-hand tightening, torque accuracy $\pm 3\%$

- Auto power off after 10" when torque is set under minimum torque threshold
- Display will remain on with set torque value
- Torque setting to decimal digit
- Power supply: battery 1 3V (included)



UNI EN ISO 6789

Nm	mm	D	A	L	g
10÷60	3/8	30	33	335	655

665/6 1 006650006

Nm	mm	D	A	L	g
20÷100	3/8	30	33	375	725

665/10 1 006650010

Nm	mm	D	A	L	g
20÷100	1/2	30	37	375	725

665/10X 1 006650011

Nm	mm	D	A	L	g
40÷200	1/2	40	43	470	995

665/20 1 006650020

Nm	mm	D	A	L	g
60÷330	1/2	40	43	590	1260

665/30 1 006650030

665LB

mechanical torque wrench, digital readout, with reversible ratchet, for right-hand tightening, torque accuracy: $\pm 3\%$

- Unit of measurement: lbf.ft
- Torque is easy to set and read through value shown on display
- Display remains on with set torque value
- Torque reading to 0.1 mm
- Automatic switch-off after 30 sec. with torque setting under minimum threshold
- Power supply: 1 3V battery (included)



UNI EN ISO 6789

lbf.ft	mm	D	A	L	g
7÷45	3/8	30	33	335	655

665LB/6 1 006650106

lbf.ft	mm	D	A	L	g
15÷75	3/8	30	33	375	725

665LB/10 1 006650110

lbf.ft	mm	D	A	L	g
15÷75	1/2	30	37	375	725

665LB/10X 1 006650111

lbf.ft	mm	D	A	L	g
30÷150	1/2	40	43	470	995

665LB/20 1 006650120

lbf.ft	mm	D	A	L	g
45÷240	1/2	40	43	590	1260

665LB/30 1 006650130

665SW

calibration device

- Device allows calibration of wrenches item 665 with help of torque meters 680 and 682, without having to dismantle wrench.
- Calibration is performed on several points, to compensate for nonlinear behaviour of spring.
- Fitted with a micro USB port, for firmware updates.



665SW 1 006650100

666N

click-type torque wrenches with reversible ratchets, for right-hand tightening, torque accuracy: $\pm 3\%$



UNI EN ISO 6789

Nm	Kgfm	lbf.ft	mm	D	A	L	g
5÷25	0,5÷2,5	4÷18	1/4	25	29	220	300

666N/2 1 006660002

Nm	Kgfm	lbf.ft	mm	D	A	L	g
5÷25	0,5÷2,5	4÷18	3/8	25	29	220	300

666N/2X 1 006660003

Nm	Kgfm	lbf.ft	mm	D	A	L	g
10÷50	1÷5	7÷37	3/8	30	33	325	680

666N/5 1 006660005

Nm	Kgfm	lbf.ft	mm	D	A	L	g
20÷100	2÷10	15÷75	3/8	30	33	367	730

666N/10 1 006660010

Nm	Kgfm	lbf.ft	mm	D	A	L	g
20÷100	2÷10	15÷75	1/2	30	37	367	800

666N/10X 1 006660011

Nm	Kgfm	lbf.ft	mm	D	A	L	g
40÷200	4÷20	30÷150	1/2	40	43	465	1010

666N/20 1 006660020

Nm	Kgfm	lbf.ft	mm	D	A	L	g
60÷300	6÷30	50÷220	1/2	40	43	581	1380

666N/30 1 006660030

Beta
Quality Tools



666N LBF.IN

click-type torque wrenches
with reversible ratchets,
for right-hand tightening
torque accuracy: $\pm 3\%$
• Scale in pounds force per inch



UNI EN ISO 6789

lbf.in	mm	D	A	L	g
90÷440	3/8	30	33	325	660

666N-LBF.IN/5 1 006660055

lbf.in	mm	D	A	L	g
200÷900	3/8	30	33	367	730

666N-LBF.IN/10 1 006660070

lbf.in	mm	D	A	L	g
200÷900	1/2	30	37	367	800

666N-LBF.IN/10X 1 006660071

lbf.in	mm	D	A	L	g
400÷1800	1/2	40	43	465	1010

666N-LBF.IN/20 1 006660072

lbf.in	mm	D	A	L	g
500÷3000	1/2	40	43	581	1380

666N-LBF.IN/30 1 006660073

667N

click-type torque wrenches
with push-through ratchets,
for right-hand and left-hand tightening,
torque accuracy: $\pm 3\%$



UNI EN ISO 6789

Nm	Kgfm	lbf.ft	mm	D	A	L	g
40÷200	4÷20	30÷150	1/2	40	43	465	1010

667N/20 1 006670020

Nm	Kgfm	lbf.ft	mm	D	A	L	g
60÷300	6÷30	50÷220	1/2	40	43	581	1380

667N/30 1 006670030

Nm	Kgfm	lbf.ft	mm	D	A	L	g
80÷400	8÷40	60÷295	3/4	50	50	687	2090

667N/40 1 006670040

Spare parts
rotating mechanism of ratchets,
see table after item 929/C8

668N

click-type torque bars,
for right-hand and left-hand tightening,
torque accuracy: $\pm 3\%$

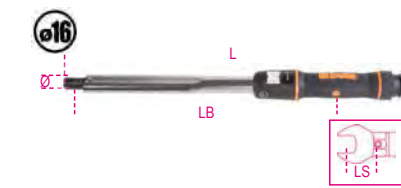

UNI EN ISO 6789

Nm	Kgfm	lbf.ft	mm	Ø	L	LB	LS	g
5÷25	0,5÷2,5	4÷18	16	220	148	32	300	

668N/2 1 006680002

Nm	Kgfm	lbf.ft	mm	Ø	L	LB	LS	g
10÷50	1÷5	7÷37	16	307	229	32	590	

668N/5 1 006680005

Nm	Kgfm	lbf.ft	mm	Ø	L	LB	LS	g
20÷100	2÷10	15÷75	16	376	269	32	670	

668N/10 1 006680010

Nm	Kgfm	lbf.ft	mm	Ø	L	LB	LS	g
40÷200	4÷20	30÷150	16	450	352,6	32	795	

668N/20 1 006680020

Nm	Kgfm	lbf.ft	mm	Ø	L	LB	LS	g
60÷300	6÷30	50÷220	16	588	475,9	32	1230	

668N/30 1 006680030

668RG

click-type torque bar, ungraduated
for right-hand and left-hand tightening
torque accuracy: $\pm 4\%$
(to be used with items 680 - 682)



UNI EN ISO 6789

Nm	Kgfm	lbf.ft	mm	Ø	L	g
8÷60	0,8÷6	6÷44	16	288	550	

668RG/6 1 006680206

Nm	Kgfm	lbf.ft	mm	Ø	L	g
20÷100	2÷10	15÷80	16	315	600	

668RG/10 1 006680210

Nm	Kgfm	lbf.ft	mm	Ø	L	g
40÷200	4÷20	30÷150	16	405	780	

668RG/20 1 006680220

Nm	Kgfm	lbf.ft	mm	Ø	L	g
60÷300	6÷30	50÷220	16	645	1130	

668RG/30 1 006680230

668RGC

click-type torque wrench,
ungraduated,
for right-hand tightening,
torque accuracy: $\pm 4\%$
(for use with items 680/40 - 682)



UNI EN ISO 6789

Nm	Kgfm	lbf.in	mm	D	A	L	g
12÷60	1,2÷6	5÷45	3/8	30	33	295	600

668RGC/6 1 006680406

Nm	Kgfm	lbf.in	mm	D	A	L	g
20÷100	2÷10	15÷75	3/8	30	33	335	700

668RGC/10 1 006680410

Nm	Kgfm	lbf.in	mm	D	A	L	g
20÷100	2÷10	15÷75	1/2	40	43	342	700

668RGC/10X 1 006680411

Nm	Kgfm	lbf.in	mm	D	A	L	g
40÷200	4÷20	30÷150	1/2	40	43	425	1000

668RGC/20 1 006680420



669N

click-type torque bars,
rectangular drive,
for right-hand and left-hand tightening,
torque accuracy: $\pm 3\%$



UNI EN ISO 6789

Nm	Kgfm	lbf.ft	mm	L mm	LB mm	LS mm	g
5÷25	0,5÷2,5	4÷18	9x12	215	140	28,8	300

669N/2 1 006690220

Nm	Kgfm	lbf.ft	mm	L mm	LB mm	LS mm	g
10÷50	1÷5	7÷37	9x12	307	226,8	28,8	590

669N/5 1 006690205

Nm	Kgfm	lbf.ft	mm	L mm	LB mm	LS mm	g
20÷100	2÷10	15÷75	9x12	376	266,8	28,8	670

669N/10 1 006690210

Nm	Kgfm	lbf.ft	mm	L mm	LB mm	LS mm	g
40÷200	4÷20	30÷150	9x12	450	345,6	28,8	795

669N/20 1 006690220

Nm	Kgfm	lbf.ft	mm	L mm	LB mm	LS mm	g
40÷200	4÷20	30÷150	14x18	450	351	39,8	795

669N/20X 1 006690221

Nm	Kgfm	lbf.ft	mm	L mm	LB mm	LS mm	g
60÷300	6÷30	50÷220	14x18	588	468,5	39,8	1230

669N/30 1 006690230

Nm	Kgfm	lbf.ft	mm	L mm	LB mm	LS mm	g
80÷400	8÷40	60÷295	14x18	588	563	39,8	2100

669N/40 1 006690240

671B/C5

torque bar item 604B/5 and accessories

14"



671B/C5 1 006710001

604B/5	1÷5 Nm
611	1/4
641	5-6-7-8 mm
900	4-5-5,5-6-7-8-9-10 mm

270x120x45 mm - 1,3 kg

671B/C10

torque bar item 604B/10 and accessories

14"



671B/C10 1 006710002

604B/10	2÷10 Nm
611	1/4
641	6-7-8-10 mm
900	4-5-5,5-6-7-8-9-10 mm

270x120x45 mm - 1,4 kg

671N/C10

torque bar 668N/10
and accessories

38"



671N/C10 1 006710110

668N/10	100 Nm
612	3/8
617	3/8
642	10-13-14-17-19 mm
652	10-13-14-17-19 mm
910A	3/8 8-10-11-13-14-17-19 mm
910/21	125 mm
910/22	250 mm

400x180x45 mm - 4,3 kg

671N/C20

torque bar 668N/20
and accessories

12"



671N/C20 1 006710120

668N/20	200 Nm
614	1/2
619	1/2
642	10-13-14-17-19 mm
652	10-13-14-17-19 mm
920A	1/2 10-11-13-14-17-19-22 mm
920/20	75 mm
920/21	125 mm
920/22	255 mm

510x180x45 mm - 5,5 kg

671N/C30

torque bar 668N/30
and accessories

12"



671N/C30 1 006710130

668N/30	300 Nm
614	1/2
619	1/2
642	13-14-17-19 mm
652	13-14-17-19 mm
920A	1/2 13-14-17-19-22-24-27 mm
920/20	75 mm
920/21	125 mm
920/22	255 mm

620x180x45 mm - 5,8 kg

677

break-back torque wrenches
with push-through ratchets
for right-hand and left-hand tightening
torque accuracy: $\pm 4\%$

34"



UNI EN ISO 6789

Nm	Kgfm	lbf.ft	D mm	A mm	L mm	kg
100÷500	10÷50	70÷350	70	55	915	5,2

677/50 1 006770050

Nm	Kgfm	lbf.ft	D mm	A mm	L mm	kg
150÷700	15÷70	100÷500	70	55	1140	6,2

677/70 1 006770070



Nm	Kgfm	lbf.ft	D mm	A mm	L mm	kg
300÷1000	30÷100	200÷750	70	55	1470	7,5

677/100 1 006770100

677/C

break-back torque wrenches with push-through ratchets, for right-hand and left-hand tightening, torque accuracy: $\pm 4\%$ in case



UNI EN ISO 6789

Nm	Kgfm	lbf.ft	D mm	A mm	L mm	kg
100÷500	10÷50	70÷350	70	55	915	5,2

677/C50 1 006770606

Nm	Kgfm	lbf.ft	D mm	A mm	L mm	kg
150÷700	15÷70	100÷500	70	55	1140	6,2

677/C70 1 006770611

Nm	Kgfm	lbf.ft	D mm	A mm	L mm	kg
300÷1000	30÷100	200÷750	70	55	1470	7,5

677/C100 1 006770615

Nm	Kgfm	lbf.ft	D mm	A mm	L mm	kg
700÷1500	70÷150	500÷1000	70	70	1475	10,4

677/C150 1 006770620

677/CP200

break-back torque wrenches with push-through ratchets for right-hand and left-hand tightening torque accuracy: $\pm 4\%$ in case



UNI EN ISO 6789

Nm	kgfm	lbf.in	D mm	A mm	L mm	kg
900÷2000	90÷200	600÷1500	70	63	1920	13

677/CP200 1 006770720

678/C

click-type torque wrenches with push-through ratchets for right-hand and left-hand tightening, torque accuracy: $\pm 4\%$ in case

• Models 678/C100 and 678/C150 supplied complete with extensions.



UNI EN ISO 6789

Nm	Kgfm	lbf.ft	D mm	A mm	L mm	kg
130÷650	13÷65	100÷480	63	55	885	3,9

678/C65 1 006780607

Nm	Kgfm	lbf.ft	D mm	A mm	L mm	kg
300÷1000	30÷100	220÷750	75	60	1250	6,0

678/C100 1 006780611

Nm	Kgfm	lbf.ft	D mm	A mm	L mm	kg
500÷1500	50÷150	370÷1100	75	60	1570	8,5

678/C150 1 006780615

677/CV - 678/CV

empty cases for torque wrenches items 677 and 678



677/CV1 1 006770450

677/C50-677/C70

678/CV1 1 006780455

678/CV2 1 006780500

678/CV3 1 006780415

677/C100

677/C100-677/C150-678/C150



680

electronic digital torque meter Dynatester 680 for checking calibration, can be used both clockwise and anticlockwise

• Accuracy: $\pm 1\%$
• 3 measuring units: Nm - lbf.ft. - lbf.in



	Nm	kg	
680/2,5	1÷25	2,6	1 006800002
680/40	15÷400	4,0	1 006800040
680/100	100÷1000	4,8	1 006800100

682

electronic digital torque meter with transducer Dynatester 682 to be used either clockwise or anticlockwise Remarkable reading accuracy Supplied with serial output RS 232 for printers



682/60 10
682/400 22
682/1500 36

TECHNICAL FEATURES

Reading accuracy
 $\pm 1\%$ of the read value
Available measuring units
Nm-dNm-cNm-Lbf.ft-Lbf.in-Ozf.in-Kgf.m-Kgf.cm-gf.cm
Supply range
90 to 264 V AC at 50/60 Hz
Dimensions 235x185x185 mm
Tolerance test according to norm ISO 6789
Acceptability range for each torque wrench tested
Display
Menu available in 11 languages
Provided with all certificates required
Calibration certificate with UKAS traceability

	Nm	kg	
682/60	1,2÷60	5,9	1 006820006
682/400	8÷400	6,1	1 006820040
682/1500	30÷1500	6,4	1 006820150

710

impact sockets, standard series



UNI/ISO 2725 DIN 3129

mm	Ø	L	Ø1		
7	12,5	28	19	3	007100007
8	13,8	28	19	3	007100008
9	15,0	28	19	3	007100009
10	16,3	28	19	3	007100010
11	17,5	30	19	3	007100011
12	19,0	30	19	3	007100012
13	20,0	30	22	3	007100013
14	21,3	30	22	3	007100014
16	23,8	30	22	3	007100016
17	25,0	30	22	3	007100017
18	26,3	30	22	3	007100018
19	27,5	30	22	3	007100019
21	30,0	32	22	3	007100021
22	32,0	32	22	3	007100022

710/C10

10 impact sockets



710/C10
7-8-10-11-12-13
14-17-19-22 mm

130x55x40 mm - 800 g

710/16

impact adaptor, 3/8" female and 1/2" male drives



L Ø
mm mm 3/8 1/2
32 22

710/20

3/8" drive impact extension bar



L Ø
mm mm
75 22

710/21

3/8" drive impact extension bar



L Ø
mm mm
125 22

710/25

3/8" drive impact universal joint



L Ø
mm mm
58 24

710/OR... - 710/SP...

rubber O-rings and locking pins for impact sockets



	710 mm	710/16 L mm		
710/OR1	7-12		10	007100921
710/OR2	13-22	32	10	007100922
710/SP1	7-12		10	007100911
710/SP2	13-22	32	10	007100912

720

impact sockets, standard series



UNI/ISO 2725 DIN 3129

mm	Ø	L	Ø1		
8	15,0	38	25	5	007200008
9	16,0	38	25	5	007200009
10	17,0	38	25	5	007200010
11	18,5	38	25	5	007200011
12	20,0	38	25	5	007200012
13	21,0	38	25	5	007200013
14	22,5	38	25	5	007200014
15	23,0	38	30	5	007200015
16	25,0	38	30	5	007200016
17	26,0	38	30	5	007200017
18	27,5	38	30	5	007200018
19	28,5	38	30	5	007200019
21	31,0	38	30	5	007200021
22	32,5	38	30	5	007200022
23	34,0	38	30	5	007200023
24	35,0	38	30	5	007200024
27	38,5	45	30	3	007200027
30	42,0	50	30	3	007200030
32	44,0	50	30	3	007200032
36	50,0	50	30	3	007200036

720/C6

6 impact sockets



720/C6
13-14-17-19-22-24 mm

195x80x55 mm - 1100 g

720/C12

12 impact sockets



720/C12
10-11-12-13-14-17
19-22-24-27-30-32 mm

195x80x55 mm - 2000 g

720MC

impact sockets, standard series, coloured



mm	Ø	L		
10	17,0	38		3 007202010
11	18,5	38		3 007202011
12	20,0	38		3 007202012
13	21,0	38		3 007202013
14	22,5	38		3 007202014
15	23,0	38		3 007202015
16	25,0	38		3 007202016
17	26,0	38		3 007202017
18	27,5	38		3 007202018
19	28,5	38		3 007202019
21	31,0	38		2 007202021
22	32,5	38		2 007202022
24	35,0	38		2 007202024

720MC/C13

12 impact sockets, coloured

12"



720MC/C13

10-11-12-13-14-15
16-17-18-19-21-22
24 mm

1 007202913

335x145x60 mm - 2,4 kg

720AS

impact sockets, standard series

12"



mm	Ø	L	Ø1		
mm	mm	mm	mm		
3/8	17,0	38	25	2	007200210
7/16	18,2	38	25	2	007200211
1/2	20,7	38	25	2	007200213
9/16	22,0	38	25	2	007200214
5/8	24,5	38	30	2	007200216
11/16	25,7	38	30	2	007200217
3/4	28,2	38	30	2	007200219
13/16	30,7	38	30	2	007200221
7/8	32,0	38	30	2	007200222
15/16	34,5	38	30	2	007200224
1	35,7	38	30	2	007200225
1.1/16	38,2	40	30	1	007200227
1.1/8	40,7	42	30	1	007200229
1.1/4	44,5	42	30	1	007200232

720S

impact sockets, compact series

12"



mm	Ø	L	Ø1		
mm	mm	mm	mm		
13	20,0	28,0	23,8	3	007200113
15	23,0	28,0	23,8	3	007200115
17	25,8	28,0	25,8	3	007200117
19	27,8	28,0	27,8	3	007200119
22	31,8	28,0	30,0	3	007200122
24	33,8	28,0	30,0	3	007200124

12"



720S/SB6

13-15-17-19-22-24 mm

1 007200906

720L

impact sockets, long series

12"



UNI/ISO 2725

mm	Ø	L	Ø1		
mm	mm	mm	mm		
10	17,0	80	25	2	007200310
11	18,5	80	25	2	007200311
12	20,0	80	25	2	007200312
13	21,0	80	25	2	007200313
14	22,5	80	25	2	007200314
15	23,0	80	30	2	007200315
16	25,0	80	30	2	007200316
17	26,0	80	30	2	007200317
18	27,5	80	30	2	007200318
19	28,5	80	30	2	007200319
21	31,0	80	30	2	007200321
22	32,5	80	30	2	007200322
24	35,0	80	30	2	007200324
27	38,5	80	30	2	007200327
30	42,0	80	30	2	007200330
32	44,0	80	30	2	007200332
36	50,0	80	30	2	007200336

720L/S3

set of 3 impact sockets item 720L

12"



mm
17-19-21

1 007200355

720LS

impact sockets,
long, slim series

12"



UNI/ISO 2725

mm	Ø	L	Ø1		
mm	mm	mm	mm		
10	15,5	78	24	2	007200360
11	16,7	78	24	2	007200361
12	18,0	78	24	2	007200362
13	19,2	78	24	2	007200363
14	20,5	78	24	2	007200364
15	21,7	78	24	2	007200365
16	23,0	78	24	2	007200366
17	24,2	78	29	2	007200367
18	25,5	78	29	2	007200368
19	26,7	78	29	2	007200369
21	29,2	78	29	2	007200371
22	30,5	78	29	2	007200372
24	33,0	78	29	2	007200374
27	36,7	78	29	2	007200377
30	40,5	78	29	2	007200380
32	43,0	78	29	2	007200382
36	48,0	78	29	2	007200386

720LC

wheel nut impact sockets,
with coloured polymeric inserts

12"



mm	Ø				
mm	mm				
17	26,5	Blue	2	007200637	
19	28,5	Yellow	2	007200639	
21	30,3	Red	2	007200641	
22	32,4	Green	2	007200642	
24	34,6	Purple	2	007200644	

12"



720LC/C3

17-19-21 mm

148x132x44 mm - 860 g

1 007200653

12"



720LC/S5

17-19-21-22-24 mm

1 007200645

720IC

spare coloured polymeric inserts for impact
sockets 720LC-720LCL



720IC	mm				
720IC 17	17	Blue	1	007200687	
720IC 19	19	Yellow	1	007200689	
720IC 21	21	Red	1	007200691	
720IC 22	22	Green	1	007200692	
720IC 24	24	Purple	1	007200694	

720LCL

wheel nut impact sockets
with coloured polymeric inserts,
long series



mm	∅			
17	26,5			1 007200737
19	28,5			1 007200739
21	30,3			1 007200741



720LCL/C3
17-19-21 mm
210x50x150 mm - 1,65 kg

720MRC

impact socket
with polymeric insert for Mercedes wheel
screw

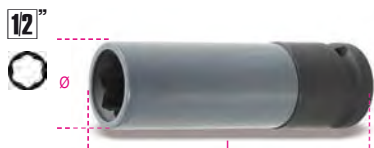

mm	∅	L		
17	27	85		1 007200631

720TC

impact torsion bars, coloured,
for motor vehicle wheel nuts,
with 1/2" male and female square drives



Nm	L			
90	200			1 007200769
100	200			1 007200770
110	200			1 007200771
120	200			1 007200772
135	200			1 007200773

12"



720TC/S5
90-100-110-120-135 Nm
260x50x175 mm - 1,35 kg

720FTX

impact sockets, for Torx® head screws



	∅	L	∅1		
E10	14,0	38	25		2 007200410
E12	15,9	38	25		2 007200412
E14	17,7	38	25		2 007200414
E16	20,0	38	25		2 007200416
E18	22,0	38	25		2 007200418
E20	25,0	40	25		2 007200420
E24	30,0	40	30		2 007200424



720FTX/SB6
E10-E12-E14
E16-E18-E20

720TX

impact socket drivers for Torx® head screws



	∅	L	L1		
T30	25	78	54		3 007200460
T40	25	78	54		3 007200470
T45	25	78	54		3 007200472
T50	25	78	54		3 007200474
T55	25	78	54		3 007200476
T60	25	78	54		3 007200478

Beta

720TX/C6

6 impact socket drivers for Torx® head screws



720TX/C6
T30-T40-T45
T50-T55-T60

275x120x65 mm - 5700 g

720ME

impact socket drivers for hexagon screws



mm	∅	L	L1		
5	25	78	54		3 007200505
6	25	78	54		3 007200506
8	25	78	54		3 007200508
10	25	78	54		3 007200510
12	25	78	54		3 007200512
14	25	78	54		3 007200514
17	25	78	54		3 007200517
19	25	78	54		3 007200519

720ME/C8

8 impact socket drivers
for hexagon screws



720ME/C8
5-6-8-10-12
14-17-19 mm

270x120x45 mm - 1710 g

Beta

720/15

impact adaptor, 1/2" female and 3/8" male drives



L	Ø				
mm	mm	□	■		
37,5	25	1/2	3/8	3	007200810



Always apply torque loads evenly and progressively to avoid breakage and any possible injury.

720/16

impact adaptor, 1/2" female and 3/4" male drives



L	Ø				
mm	mm	□	■		
44	30	1/2	3/4	3	007200814

720/20

1/2" drive impact extension bar



L	Ø				
mm	mm				
75	25			3	007200818

720/21

1/2" drive impact extension bar



L	Ø				
mm	mm				
125	25			3	007200822

720/25

1/2" drive impact universal joint



L	Ø				
mm	mm				
64	28			2	007200831

720/OR... - 720/SP...

rubber O-rings and locking pins for impact sockets



	720	720TX			
	mm	mm			
720/OR1	10+14	T30+T60	10	007200923	
720/OR2	15+32		10	007200924	
720/SP1	10+14	T30+T60	10	007200913	
720/SP2	15+32		10	007200914	

727PI/16

impact bit holder for item 727/ES16 and 727/ES16TX

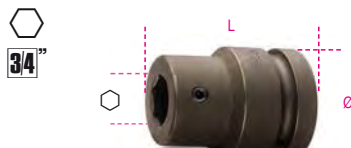

Ø	L	Ø	□		
mm	mm	mm	□		
44	52	16	3/4	2	007270016

727/ES16

impact hexagon bits, 16 mm drive



mm	●	L			
mm	mm	mm			
10	16	40	2	007270110	
12	16	40	2	007270112	
13	16	40	2	007270113	
14	16	40	2	007270114	
16	16	40	2	007270116	
17	16	40	2	007270117	
18	16	40	2	007270118	
19	16	40	2	007270119	
22	16	40	2	007270122	

727/ES16TX

impact bits for Torx® head screws, 16 mm drive



Ø	●	L			
mm	mm	mm			
T55	16	50	2	007270355	
T60	16	50	2	007270360	
T70	16	50	2	007270370	

727PI/22

impact bit holder for item 727/ES22 and 727/ES22TX



Ø	L	Ø			
mm	mm	mm			
54	70	22	2	007270022	

727/ES22

impact hexagon bits, 22 mm drive



mm	●	L			
mm	mm	mm			
19	22	50	2	007270219	
22	22	50	2	007270222	
24	22	50	2	007270224	
27	22	50	2	007270227	
30	22	50	2	007270230	
32	22	50	2	007270232	

727/ES22TX

impact bits for Torx® head screws, 22 mm drive



Ø	●	L			
mm	mm	mm			
T80	22	60	2	007270480	
T90	22	60	2	007270490	
T100	22	60	2	007270500	

727/C16

12 impact bits and 4 accessories



727/C16	1	007270900
---------	---	-----------

727PI/16

727/ES16 14-17-19 mm

727/ES16TX T55-T60-T70

727PI/22

727/ES22 22-24-27 mm

727/ES22TX T80-T90-T100

96BPC 3-4 mm

335x145x60 mm - 3,6 kg

727PI/32

impact bit holder
for item 727/ES32



Ø mm	L mm	Ø mm	
86	66	32	1 007270032

727/ES32

impact hexagon bit,
32 mm drive



mm	Ø mm	L mm	
19	32	44	2 007270519
22	32	44	2 007270522
24	32	44	2 007270524
27	32	44	2 007270527
30	32	44	2 007270530
32	32	44	2 007270532
36	32	44	2 007270536

728

impact sockets, standard series



UNI/ISO 2725 DIN 3129

Ø mm	L mm	Ø1 mm		
17	30,0	51	44	2 007280017
18	31,0	51	44	2 007280018
19	32,5	51	44	2 007280019
21	35,0	51	44	2 007280021
22	36,0	51	44	2 007280022
23	37,5	51	44	2 007280023
24	38,5	51	44	2 007280024
27	42,5	53	44	2 007280027
28	44,0	53	44	2 007280028
30	46,0	53	44	2 007280030
32	48,5	57	44	2 007280032
33	50,0	57	44	2 007280033
34	51,0	57	44	2 007280034
35	52,5	57	44	2 007280035
36	53,5	57	44	2 007280036
38	56,0	57	44	1 007280038
40	58,5	58	44	1 007280040
41	60,0	58	44	1 007280041
44	64,0	62	44	1 007280044
45	65,0	62	44	1 007280045
46	66,0	62	44	1 007280046
50	71,0	68	54	1 007280050
55	77,5	71	54	1 007280055
60	83,0	73	54	1 007280060
65	88,0	78	54	1 007280065

728/C10

10 impact sockets



728/C10
17-19-22-24-27-30
32-36-41-46 mm

275x120x65 mm - 5,7 kg

728AS

impact sockets,
standard series



Ø mm	L mm	Ø1 mm		
3/4	32,0	51	41	1 007280219
13/16	35,0	51	41	1 007280221
7/8	36,0	51	41	1 007280222
15/16	38,5	51	41	1 007280224
1	40,0	53	41	1 007280225
1.1/16	42,5	53	44	1 007280227
1.1/8	44,0	53	44	1 007280230
1.1/4	48,5	57	44	1 007280232
1.5/16	50,0	57	44	1 007280233
1.7/16	53,5	57	44	1 007280236
1.1/2	56,0	57	44	1 007280238
1.5/8	60,0	58	44	1 007280241

728FTX

impact sockets, for Torx® head screws



Ø mm	L mm	Ø1 mm		
E20	28,5	50	44	2 007280420
E22	30,0	50	44	2 007280422
E24	32,5	50	44	2 007280424

728L

impact sockets, long series



Ø mm	L mm	Ø1 mm		
19	32,5	90	44	2 007280319
21	35,0	90	44	2 007280321
22	36,0	90	44	2 007280322
24	38,5	90	44	2 007280324
26	41,0	90	44	2 007280326
27	42,5	90	44	2 007280327
30	46,0	90	44	2 007280330
32	48,5	90	44	2 007280332

Ø mm	L mm	Ø1 mm		
33	50,0	90	44	1 007280333
34	51,0	90	44	1 007280334
36	53,5	90	44	1 007280336
38	56,0	90	44	1 007280338
41	60,0	90	44	1 007280341
44	64,0	90	44	1 007280344
46	66,0	90	44	1 007280346
50	71,0	90	44	1 007280350
55	77,5	100	54	1 007280355



728L/S3
30-32-36 mm

728LS

impact sockets, long slim series



Ø mm	L mm	Ø1 mm		
17	28,0	100	43	2 007280517
19	30,5	100	43	2 007280519
22	34,3	100	43	2 007280522
24	36,8	100	43	2 007280524
27	40,5	100	43	2 007280527
30	44,3	100	43	2 007280530
32	46,8	100	43	2 007280532
33	48,0	100	43	2 007280533
36	51,8	100	43	1 007280536

728LQ

impact sockets, long series

(for ISUZU wheel nuts)



Ø mm	L mm	Ø1 mm		
19	90	35	43,5	1 007280619
21	90	42	43,5	1 007280621

728/15

impact adaptor, 3/4" female
and 1/2" male drives



L mm	Ø mm	Ø1 mm	
58	38	3/4 1/2	2 007280810



Always apply torque loads evenly
and progressively to avoid breakage
and any possible injury.

728/16
impact adaptor, 3/4" female and 1" male drives



728/21
3/4" drive impact extension bar



728/22
3/4" drive impact extension bar



728/22L
3/4" drive impact extension bar



728/25
3/4" drive impact universal joint



728/OR - 728/SP
rubber O-rings and locking pins for impact sockets

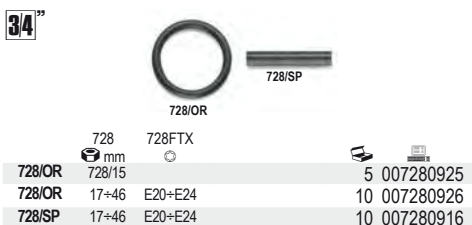

729
impact sockets, standard series



UNI/ISO 2725 DIN 3129

mm	Ø	L	Ø1	
24	41,5	58	54	1 007290024
27	45,0	60	54	1 007290027
30	49,0	62	54	1 007290030
32	51,5	63	54	1 007290032
33	52,5	63	54	1 007290033
34	54,0	63	54	1 007290034
36	56,5	66	54	1 007290036
38	59,0	66	54	1 007290038
41	62,5	68	54	1 007290041
46	69,0	72	54	1 007290046
50	74,0	76	54	1 007290050
55	80,0	84	54	1 007290055
60	86,5	88	54	1 007290060
65	92,5	92	54	1 007290065
70	99,0	96	54	1 007290070
75	105,0	102	63	1 007290075
80	111,5	102	63	1 007290080

729L
impact sockets, long series



mm	Ø	L	Ø1	
24	41,5	108	54	1 007290324
27	45,0	108	54	1 007290327
30	49,0	108	54	1 007290330
32	51,5	108	54	1 007290332
33	52,2	108	54	1 007290333
34	54,0	108	54	1 007290334
36	56,5	108	54	1 007290336
41	62,5	108	54	1 007290341
46	69,0	108	54	1 007290346
50	74,0	108	54	1 007290350
55	80,0	108	54	1 007290355
60	86,5	108	54	1 007290360
65	92,5	108	54	1 007290365
70	99,0	108	54	1 007290370
75	105,0	108	63	1 007290375
80	111,5	108	63	1 007290380

729LS
impact sockets, long slim series



mm	Ø	L	Ø1	
22	36,0	108	53	1 007290522
24	38,5	108	53	1 007290524
27	46,0	108	53	1 007290527
30	50,0	108	53	1 007290530
32	50,0	108	53	1 007290532
33	52,0	108	53	1 007290533
36	56,0	108	53	1 007290536

729T
impact torsion bars for wheel nuts



mm	Nm	L	
24	350	300	1 007290724
27	450	300	1 007290757
30	500	300	1 007290730
32	450	300	1 007290732
32	600	300	1 007290762
33	600	300	1 007290763
36	600	300	1 007290736

729/15
impact adaptor, 1" female and 3/4" male drives



! Always apply torque loads evenly and progressively to avoid breakage and any possible injury.

729/16
impact adaptor, 1" female and 1.1/2" male drives



729/21
1" drive impact extension bar



729/22
1" drive impact extension bar



729/25

1" drive impact universal joint



L	Ø		
mm	mm		
130	54	1	007290830

729/OR... - 729/SP...

rubber O-rings and locking pins for impact sockets



	728	729-730		
	mm	mm		
729/OR1	50+60	24+70	5	007290927
729/OR2	75+125		5	007290928
729/SP1	50+60	24+70	5	007290917
729/SP2	75+125		5	007290918

730

impact sockets, standard series



UNI/ISO 2725 DIN 3129

Ø	Ø	L	Ø1		
mm	mm	mm	mm		
50	81	87	84	1	007300050
55	88	90	86	1	007300055
60	94	95	86	1	007300060
65	100	100	86	1	007300065
70	106	105	86	1	007300070
75	113	110	86	1	007300075
80	119	115	86	1	007300080
85	125	120	86	1	007300085
90	132	125	86	1	007300090
95	138	125	96	1	007300095
100	144	130	96	1	007300100
105	150	135	96	1	007300105
110	157	140	96	1	007300110
115	163	140	96	1	007300115
120	169	145	96	1	007300120
125	175	145	96	1	007300125

730/15

adaptor



L	Ø		
mm	mm		
105	84,0	1.1/2	1



Always apply torque loads evenly and progressively to avoid breakage and any possible injury.

733/15

adaptor



L	Ø		
mm	mm		
156	127	2.1/2	1.1/2

851

magnetic bit holder with handle

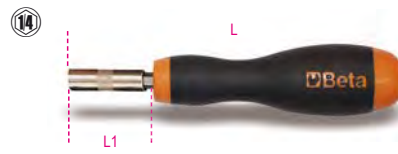

L1	L		
mm	mm		
45	165	2	008510165
125	245	2	008510245

851SR

quick release bit holder with handle



L	L1		
mm	mm		
230	110	2	008510001

852

bit holder with articulated T handle

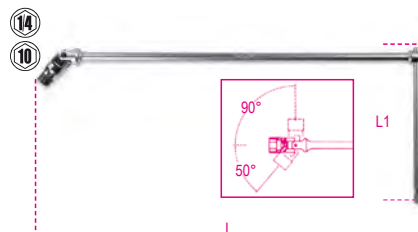

	L	L1		
	mm	mm		
1/4"	400	160	2	008520006
10 mm	400	160	2	008520010

855P

reversible ratchet bit holder with articulated handle, and 7 built-in bits

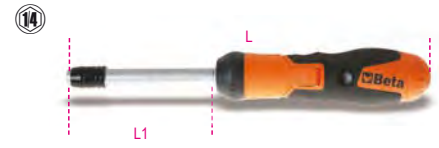

L	L1		
mm	mm		
240	100	1	008550010

	860PH	PH1 - PH2
	860PZ	PZ1 - PZ2
	860LP	LP 0,8x5,5 mm
	860PE	4 - 5 mm

860LP

bits for slotted head screws, coloured



ISO 2351-1
ISO 1173 C 6,3

SxA	L		
mm	mm		
0,5x3	25	5	008600005
0,6x4,5	25	5	008600010
0,8x5,5	25	5	008600015
1x5,5	25	5	008600020
1,2x6,5	25	5	008600025

860PH

bits for cross head Phillips® screws, coloured

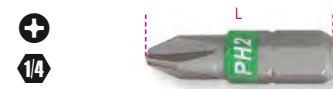

ISO 2351-2
ISO 1173 C 6,3

PH	L		
	mm		
0	25	5	008600220
1	25	5	008600225
2	25	5	008600230
3	25	5	008600245
4	25	5	008600250



860PZ

bits for cross head Pozidriv® - Supadriv® screws, coloured



ISO 2351-2
ISO 1173 C 6,3

PZ	L mm		
1	25	5	008600320
2	25	5	008600325
3	25	5	008600330
4	25	5	008600335

860PE

hexagon bits for power drivers, coloured



ISO 2351-3
ISO 1173 C 6,3

mm	L mm		
2	25	5	008600101
2,5	25	5	008600102
3	25	5	008600103
4	25	5	008600104
5	25	5	008600105
6	25	5	008600106
8	25	5	008600108
10	25	5	008600110

860TX

bits for Torx® head screws, coloured



ISO 1173 C 6,3

	L mm		
T6	25	5	008600704
T7	25	5	008600705
T8	25	5	008600710
T9	25	5	008600715
T10	25	5	008600720
T15	25	5	008600725
T20	25	5	008600730
T25	25	5	008600735
T27	25	5	008600740
T30	25	5	008600745
T40	25	5	008600750

860RTX

bits for Tamper Resistant Torx® head screws, coloured



ISO 1173 C 6,3

	L mm		
T9	25	5	008600550
T10	25	5	008600555
T15	25	5	008600560
T20	25	5	008600565
T25	25	5	008600570
T27	25	5	008600575
T30	25	5	008600580
T40	25	5	008600585

860/55

reversible bit ratchet



L mm			
100	1/4	3	008600870

860/58

bit ratchet with rotating handle

- Bit can be fitted onto both sides, for screwing or unscrewing
- Bi-material handle



L mm	Ø mm	A mm	
860/58	126	1/4"	27 15

860/C27

25 bits, 1 connector and 1 reversible ratchet in plastic case



860/C27 1 008600880

860/55	100 mm		
860LP	0,5x3-1,0x5,5-1,2x6,5 mm		
860PH	PH1-PH2(x2)-PH3		
860PZ	PZ1-PZ2(x2)-PZ3		
860PE	2-2,5-3-4-5-6 mm		
860TX	T6-T8-T10-T15-T20-T25-T30-T40		
892/0	● 1/4 ■ 1/4		

860PHZ/A10

set of 10 bits with magnetic bit holder in plastic case



860PHZ/A10 1 008600910

			n.
860PH	PH1		1
	PH2		3
	PH3		1
860PZ	PZ1		1
	PZ2		3
	PZ3		1
882M1	○ 1/4 ● 1/4		

860PE/A10

set of 10 bits with magnetic bit holder in plastic case



860PE/A10 1 008600920

			n.
860PE	2 - 2,5 mm		1
	3 - 4 - 5 - 6 mm		2
882M1	○ 1/4 ● 1/4		

860TX/A10

set of 10 bits with magnetic bit holder in plastic case



860TX/A10 1 008600970

860TX	T7 - T8 - T9 - T10 - T15 - T20 T25 - T27 - T30 - T40	1
882M1	○ 1/4 ● 1/4	

860MIX/A10

set of 10 bits with magnetic bit holder in plastic case



860MIX/A10 1 008600900

860LP	0,5x3 - 1x5,5 - 1,2x6,5 mm	1
860PH	PH1 PH2 PH3	1 2 1
860PZ	PZ1 - PZ2 - PZ3	1
882M1	○ 1/4 ● 1/4	

860MIX/A31

set of 30 bits with magnetic quick release bit holder in plastic case



860MIX/A31 1 008600902

860LP	0,5x3 - 0,6x4,5 - 0,8x5,5 1,0x5,5 - 1,2x6,5 mm	1
860PE	2 - 2,5 - 3 - 4 - 5 - 6 8 - 10 mm	1
860PH	PH0 - PH1 - PH2 - PH3 - PH4	1
860PZ	PZ1 - PZ2 - PZ3 - PZ4	1
860RTX	T9 - T10 - T15 - T20 T25 - T27 - T30 - T40	1
882MSR 50	○ 1/4 ● 1/4	

860/C38P

1 reversible ratchet bit holder with articulated handle, 27 bits, 8 hexagon sockets and 2 accessories



860/C38P 1 008600878

860LP	0,6x4,5 - 0,8x5,5 - 1,0x5,5 - 1,2x6,5 mm	1
860PE	2-2,5-3-4(x2)-5(x2)	1
860PH	PH1(x2)-PH2(x2)-PH3	1
860PZ	PZ1(x2)-PZ2(x2)-PZ3	1
860TX	T10-T15-T20-T25-T30-T40	1
900	5-5,5-6-7-8-9-10-13 mm	1
892/0	● 1/4 ■ 1/4	
892/3	● 1/4 ■ 1/4	
855P	240 mm	

270x120x45 mm

861LP

bits for slotted head screws



ISO 2351-1

ISO 1173 C 6,3

SxA	L		
mm	mm		
0,5x3	25	10	008610005
0,6x4	25	10	008610007
0,6x4,5	25	10	008610010
0,8x5,5	25	10	008610015
1x5,5	25	10	008610020
1,2x6,5	25	10	008610025
1,2x8	25	10	008610028
1,6x8	25	10	008610030

861PH

bits for cross head Phillips® screws



ISO 2351-2

ISO 1173 C 6,3

PH	L		
mm	mm		
0	25	10	008610200
1	25	10	008610205
2	25	10	008610210
2L	50	10	008610213
3	25	10	008610215
4	25	10	008610220

861PH/C

bits for cross head Phillips® screws



ISO 2351-2

ISO 1173 C 6,3

PH	L		
mm	mm		
0	25	200	008610250
1	25	200	008610255
2	25	200	008610260
2L	50	100	008610263
3	25	200	008610265
4	25	100	008610270

861PZ

bits for cross head Pozidriv®-Supadriv® screws



ISO 2351-2

ISO 1173 C 6,3

PZ	L		
mm	mm		
1	25	10	008610300
2	25	10	008610305
2L	50	10	008610308
3	25	10	008610310
4	25	10	008610315



861PZ/C

bits for cross head
Pozi driv®-Supadriv® screws

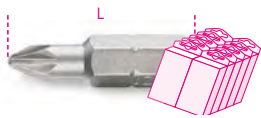

ISO 2351-2
ISO 1173 C 6,3

PZ	L mm		
1	25	200	008610350
2	25	200	008610355
2L	50	100	008610358
3	25	200	008610360
4	25	100	008610365

861PE

hexagon bits for power drivers



ISO 2351-3
ISO 1173 C 6,3

mm	L mm		
2	25	10	008610100
2,5	25	10	008610105
3	25	10	008610110
4	25	10	008610115
5	25	10	008610120
6	25	10	008610125
8	25	10	008610130
10	25	10	008610135

861TX

bits for Torx® head screws



ISO 1173 C 6,3

T	L mm		
T5	25	10	008610399
T6	25	10	008610400
T7	25	10	008610405
T8	25	10	008610410
T9	25	10	008610415
T10	25	10	008610420
T15	25	10	008610425
T20	25	10	008610430
T25	25	10	008610435
T27	25	10	008610440
T30	25	10	008610445
T40	25	10	008610450

861TX/C

bits for Torx® head screws



ISO 1173 C 6,3

T	L mm		
T10	25	200	008610470
T15	25	200	008610475
T20	25	200	008610480
T25	25	200	008610485
T27	25	200	008610490
T30	25	200	008610495
T40	25	200	008610499

861RTX

bits for Tamper Resistant Torx®
head screws



ISO 1173 C 6,3

T	L mm		
T6	25	10	008610537
T7	25	10	008610538
T8	25	10	008610540
T9	25	10	008610500
T10	25	10	008610505
T15	25	10	008610510
T20	25	10	008610515
T25	25	10	008610520
T27	25	10	008610525
T30	25	10	008610530
T40	25	10	008610535
T45	25	10	008610539

861RIBE

bits for RIBE® screws



ISO 1173 C 6,3

M	L mm		
M5	25	10	008610705
M6	25	10	008610706
M7	25	10	008610707
M8	25	10	008610708
M9	25	10	008610709

861TRW

bits for Tri-Wing® head screws



ISO 1173 C 6,3

GR	L mm		
1	25	10	008610601
2	25	10	008610602
3	25	10	008610603
4	25	10	008610604
5	25	10	008610605
6	25	10	008610606

861TQS

bits for Torq-Set® head screws



ISO 1173 C 6,3

GR	L mm		
0	25	10	008610620
1	25	10	008610621
2	25	10	008610622
3	25	10	008610623
4	25	10	008610624
5	25	10	008610625
6	25	10	008610626
8	25	10	008610628
10	25	10	008610630

861SP

bits for Spanner screws



ISO 1173 C 6,3

SP	D mm	L mm		
4	1,5	25	10	008610650
6	2,4	25	10	008610653
8	2,8	25	10	008610656
10	3,3	25	10	008610658
12	3,9	25	10	008610660

1483KV-PT/S7



1483KV PT/S7

177

861XZN

bits for XZN® screws



ISO 1173 C 6,3

M	L mm		
M5	25	10	008610725
M6	25	10	008610726
M8	25	10	008610728

861/C61P

61 bits and 1 magnetic quick release bit holder

1/4



861/C61P

1 008610978

	● 861LP	0,5x3 - 0,6x4,5 - 0,8x5,5 - 1,0x5,5 1,2x6,5 - 1,2x8 - 1,6x8 mm
	○ 861PE	2 - 2,5 - 3 - 4 - 5 - 6 - 8 - 10 mm
	⊕ 861PH	PH0 - PH1 - PH2 - PH3
	⊕ 861PZ	PZ1 - PZ2 - PZ3
	⊕ 861TX	T6 - T7 - T8 - T9 - T10 - T15 T20 - T25 - T27 - T30 - T40
	⊕ 861RTX	T9 - T10 - T15 - T20 - T25 T27 - T30 - T40
	⊕ 861TRW	1 - 2 - 3 - 4 - 5 - 6
	⊕ 861TQS	0 - 1 - 2 - 3 - 4 - 5 - 6 - 8 - 10
	⊕ 861SP	4 - 6 - 8 - 10 - 12
	○ 851SR	○ 1/4"

270x120x45 mm - 975 g

862LP

bits for slotted head screws

1/4



ISO 2351-1

ISO 1173 E 6,3

SxA mm	L mm	
0,5x3	50	5 008620005
0,6x4,5	50	5 008620010
0,8x5,5	50	5 008620015
1x5,5	50	5 008620020
1,2x6,5	50	5 008620025
1,2x8	50	5 008620030
1,6x8	50	5 008620035

862PH

bits for cross head Phillips® screws

1/4



ISO 2351-2

ISO 1173 E 6,3

PH	L mm	
1	50	5 008620200
2	50	5 008620205
3	50	5 008620210

862PH/L

bits for cross head Phillips® screws

1/4



ISO 2351-2

ISO 1173 E 6,3

PH	L mm	
1	70	5 008620230
2	70	5 008620232
3	70	5 008620234

862PH-XL

bits for cross head Phillips® screws

1/4



ISO 2351-2ISO 1173 E 6,3

PH	L mm	
1	100	5 008620250
2	100	5 008620252
3	100	5 008620254

862PZ

bits for cross head
Poizidriv®-Supadriv® screws

1/4



ISO 2351-2

ISO 1173 E 6,3

PZ	L mm	
1	50	5 008620300
2	50	5 008620305
3	50	5 008620310

862PE

hexagon bits for power drivers

1/4



ISO 2351-3

ISO 1173 E 6,3

mm	L mm	
3	50	5 008620103
4	50	5 008620104
5	50	5 008620105
6	50	5 008620106
8	50	5 008620108

862TX

bits for Torx® head screws

1/4



ISO 1173 E 6,3

	L mm	
T6	50	5 008620506
T7	50	5 008620507
T8	50	5 008620508
T9	50	5 008620509
T10	50	5 008620510
T15	50	5 008620515
T20	50	5 008620520
T25	50	5 008620525
T27	50	5 008620527
T30	50	5 008620530
T40	50	5 008620540

862TX/L

bits for Torx® head screws

1/4



ISO 1173 E 6,3

	L mm	
T6	70	5 008620556
T7	70	5 008620557
T8	70	5 008620558
T9	70	5 008620559
T10	70	5 008620560
T15	70	5 008620565
T20	70	5 008620570
T25	70	5 008620575
T27	70	5 008620577
T30	70	5 008620580
T40	70	5 008620590

862TX-XL

bits for Torx® head screws

1/4



ISO 1173 E 6,3

	L mm	
T9	100	5 008620659
T10	100	5 008620660
T15	100	5 008620665
T20	100	5 008620670
T25	100	5 008620675
T27	100	5 008620677
T30	100	5 008620680
T40	100	5 008620690

862F

magnetic bits, hexagon sockets

1/4



ISO 1173 E 6,3

mm	L mm	∅ mm	
5,5	65	11	5 008620405
6	65	11	5 008620406
7	65	11	5 008620407
8	65	13	5 008620408
10	65	15	5 008620410
12	65	18	5 008620412
13	65	18	5 008620413

862F/A7

7 magnetic bits, hexagon sockets, in plastic case



862F/A7 1 008620950

862F 5,5-6-7-8-10-12-13 mm

866LP

bits for slotted head screws



ISO 2351-1
ISO 1173 C 8

SxA mm	L mm		
1x5,5	41	10	008660005
1,2x6,5	41	10	008660010
1,6x8	41	10	008660015
1,6x10	41	10	008660020
2x12	41	10	008660025

866PH

bits for cross head Phillips® screws



ISO 2351-2
ISO 1173 C 8

PH	L mm		
1	32	10	008660200
2	32	10	008660205
3	32	10	008660210
4	38	10	008660215

866PZ

bits for cross head Pozidriv®-Supadriv® screws



ISO 2351-2
ISO 1173 C 8

PZ	L mm		
1	32	10	008660300
2	32	10	008660305
3	32	10	008660310
4	38	10	008660315

866PE

hexagon bits for power drivers



ISO 2351-3

ISO 1173 C 8

mm	L mm		
3	30	10	008660100
4	30	10	008660105
5	30	10	008660110
6	30	10	008660115
7	30	10	008660117
8	30	10	008660120
10	30	10	008660125
12	30	10	008660132
14	30	10	008660134

866TX

bits for Torx® head screws



ISO 1173 C 8

	L mm		
T20	30	10	008660400
T25	30	10	008660405
T27	30	10	008660410
T30	30	10	008660415
T40	30	10	008660420
T45	30	10	008660425
T50	30	10	008660430
T55	30	10	008660435
T60	30	10	008660440
T70	30	10	008660445

866RTX

bits for Tamper Resistant Torx® head screws



ISO 1173 C 8

	L mm		
T40	30	10	008660520
T45	30	10	008660525
T50	30	10	008660530
T55	30	10	008660535
T60	30	10	008660540
T70	30	10	008660545

867PE

hexagon bits



mm	L mm		
4	30	5	008670104
5	30	5	008670105
6	30	5	008670106
7	30	5	008670107
8	30	5	008670108
10	30	5	008670110
12	30	5	008670112

867PE/L

hexagon bits



mm	L mm		
4	75	5	008670154
5	75	5	008670155
6	75	5	008670156
7	75	5	008670157
8	75	5	008670158
10	75	5	008670160
12	75	5	008670162

867XZN

bits with XZN® profile



	L mm		
M4	30	5	008670204
M5	30	5	008670205
M6	30	5	008670206
M8	30	5	008670208
M10	30	5	008670210
M12	30	5	008670212

867XZN/L

bits with XZN® profile



	L mm		
M5	75	5	008670255
M6	75	5	008670256
M8	75	5	008670258
M10	75	5	008670260
M12	75	5	008670262

Beta
Quality Tools

867TX

bits for Torx® head screws



⊕	L mm	🔧	📦
T20	30	5	008670400
T25	30	5	008670405
T30	30	5	008670410
T40	30	5	008670415
T45	30	5	008670420
T50	30	5	008670425
T55	30	5	008670430

867TX/L

bits for Torx® head screws



⊕	L mm	🔧	📦
T20	75	5	008670450
T25	75	5	008670455
T30	75	5	008670460
T40	75	5	008670465
T45	75	5	008670470
T50	75	5	008670475
T55	75	5	008670480

867RTX

bits for Tamper Resistant Torx® head screws



⊕	L mm	🔧	📦
T20	30	5	008670500
T25	30	5	008670505
T30	30	5	008670510
T40	30	5	008670515
T45	30	5	008670520
T50	30	5	008670525
T55	30	5	008670530

867RTX/L

bits for Tamper Resistant Torx® head screws



⊕	L mm	🔧	📦
T20	75	5	008670550
T25	75	5	008670555
T30	75	5	008670560
T40	75	5	008670565
T45	75	5	008670570
T50	75	5	008670575
T55	75	5	008670580

867RIBE

bits for RIBE® screws



⊕	L mm	🔧	📦
M5	30	5	008670705
M6	30	5	008670706
M7	30	5	008670707
M8	30	5	008670708
M9	30	5	008670709
M10	30	5	008670710
M11	30	5	008670711
M12	30	5	008670712
M13	30	5	008670713

867RIBE/L

bits for RIBE® screws



⊕	L mm	🔧	📦
M5	75	5	008670755
M6	75	5	008670756
M7	75	5	008670757
M8	75	5	008670758
M9	75	5	008670759
M10	75	5	008670760
M11	75	5	008670761
M12	75	5	008670762
M13	75	5	008670763

867/...

bit holder sockets for item 867



	⊕ mm	□ mm	L mm	Ø mm	🔧	📦
867/1	10	3/8"	38	17	5	008670600
867/2	10	1/2"	38	22	5	008670601

867/C20

18 bits for RIBE® screws, with 10 mm hexagon drive and 2 accessories



867/C20 1 008670920

🔧	⊕	867RIBE	5-6-7-8-9-10-11-12-13 mm
🔧	⊕	867RIBE/L	5-6-7-8-9-10-11-12-13 mm
🔧		867/1	
🔧		867/2	

📦 335x145x60 mm - 🏠 1,7 kg

867/C38

38 hexagon bits, 10 mm, 1 bit holder with articulated T handle



867/C38 1 008670938

🔧	852	10 mm
🔧	⊕ 867PE	4-5-6-7-8-10-12mm
🔧	⊕ 867PE/L	4-5-6-7-8-10-12mm
🔧	⊕ 867XZN	M5-M6-M8-M10-M12
🔧	⊕ 867XZN/L	M5-M6-M8-M10-M12
🔧	⊕ 867TX	T20-T25-T30-T40-T45-T50-T55
🔧	⊕ 867TX/L	T20-T25-T30-T40-T45-T50-T55
🔧	882	

📦 420x185x60 mm - 🏠 3 kg

867/C52

52 hexagon bits, 10 mm and 2 accessories



867/C52 1 008670901

🔧	⊕ 867PE	4-5-6-7-8-10-12 mm
🔧	⊕ 867PE/L	4-5-6-7-8-10-12 mm
🔧	⊕ 867XZN	M5-M6-M8-M10-M12
🔧	⊕ 867XZN/L	M5-M6-M8-M10-M12
🔧	⊕ 867TX	T20-T25-T30-T40-T45-T50-T55
🔧	⊕ 867TX/L	T20-T25-T30-T40-T45-T50-T55
🔧	⊕ 867RTX	T20-T25-T30-T40-T45-T50-T55
🔧	⊕ 867RTX/L	T20-T25-T30-T40-T45-T50-T55
🔧	867/1	⊕ 10 mm - □ 3/8"
🔧	867/2	⊕ 10 mm - □ 1/2"

📦 250x170x70 mm - 🏠 2,1 kg

852



852 79,114

882

bit holder with retaining ring for drivers



ISO 1173 E 6,3

L	Ø	mm	mm	mm	mm
57	1/4	1/4	11	5	008820001

882AN

bevel gearbox, 1/4" hexagon drive

- For electric drills with 10 mm and 13 mm spindles and 1/4" impact wrenches
- Max. speed: 3600 rpm
- Max. torque: 30 Nm
- With quick change bit holder
- Gear ratio: 1:1
- Connection to tool through 1/4" hexagon D6.3



ISO 1173 E 6,3
ISO 1173 C 6,3

L	Ø	mm	mm	mm	mm
137	1/4	1/4	11	1	008820090

882M1

magnetic bit holder



ISO 1173 E 6,3

L	Ø	mm	mm	mm	mm
50	1/4	1/4	11	5	008820006

882M

magnetic bit holder



ISO 1173 E 6,3

L	Ø	mm	mm	mm	mm
75	1/4	1/4	11	5	008820005

882MSR

magnetic quick release bit holder for drivers



ISO 1173 E 6,3

L	Ø	mm	mm	mm	mm
50	1/4	1/4	11	5	008820205
75	1/4	1/4	11	5	008820207

882P

magnetic bit holder extension bar



L	Ø	mm	mm	mm	mm
80	1/4	1/4	10	5	008820080

892

adaptors for drivers



	■	●	L	mm	mm	mm	mm
892/0	1/4	1/4	25	5	008920000		
* 892/1	1/4	5,5	50	5	008920001		
* 892/2	3/8	5,5	50	5	008920002		
° 892/3	1/4	1/4	50	5	008920003		
° 892/4	3/8	1/4	50	5	008920004		
892/5	1/4	5/16	75	5	008920005		
892/6	3/8	5/16	75	5	008920006		
892/7	1/2	1/4	75	5	008920007		

* ISO 1173 A 5,5
° ISO 1173 C 6,3

895

socket holder for bits
item 861 - 862 - 866



DIN 7427

	○	□	L	Ø	mm	mm	mm	mm
895/1	1/4	1/4	25,4	12	5	008950000		
895/3	1/4	3/8	29	16,8	5	008950001		
895/4	5/16	3/8	29	16,8	5	008950002		
895/5	1/4	1/2	38	22	5	008950005		
895/6	5/16	1/2	38	22	5	008950003		

897

flexible bit holder with handle



L	L1	mm	mm	mm	mm
280	154	2	008970010		

897L

flexible bit holder with handle, long model



L	L1	mm	mm	mm	mm
500	380	2	008970015		

900

hexagon hand sockets



UNI/ISO 2725 DIN 3124

mm	Ø	L	Ø1	mm	mm	mm	mm
3,2	6,6	25	11,8	10	009000032		
4	6,8	25	11,8	10	009000040		
4,5	7,4	25	11,8	10	009000045		
5	8,0	25	11,8	10	009000050		
5,5	8,7	25	11,8	10	009000055		
6	9,3	25	11,8	10	009000060		
7	10,4	25	11,8	10	009000070		
8	11,8	25	12,7	10	009000080		
9	12,7	25	11,8	10	009000090		
10	14,2	25	12,0	10	009000100		
11	15,8	25	12,5	10	009000110		
12	17,2	25	13,5	10	009000120		
13	18,0	25	13,5	10	009000130		
14	20,0	25	15,0	10	009000140		



900/SB13	mm	mm	mm	mm
4-4,5-5-5,5-6-7-8-9	1	009000150		
10-11-12-13-14 mm				

900MC

hexagon hand sockets, coloured



Ø	L	Ø	Ø1		
mm	mm	mm	mm		
4	24,8	6,7	11,8	5	009002040
5	24,8	8,0	11,8	5	009002050
6	24,8	9,2	11,8	5	009002060
7	24,8	10,7	11,8	5	009002070
8	24,8	11,8	11,8	5	009002080
9	24,8	12,8	12,8	5	009002090
10	24,8	14,8	14,8	5	009002100
11	24,8	15,8	15,8	5	009002110
12	24,8	16,8	16,8	5	009002120
13	24,8	17,8	17,8	5	009002130
14	24,8	19,5	19,5	5	009002140

900MB

bi-hex hand sockets



UNI/ISO 2725 DIN 3124

Ø	L	Ø1			
mm	mm	mm			
4	6,7	22	11,2	5	009000160
5	7,7	25	11,2	5	009000161
5,5	8,3	25	11,2	5	009000162
6	9,0	25	11,2	5	009000163
7	10,2	25	11,2	5	009000164
8	11,3	25	12,0	5	009000165
9	13,0	25	12,0	5	009000166
10	14,3	25	12,9	5	009000167
11	16,0	25	14,3	5	009000168
12	17,4	25	16,0	5	009000169
13	18,0	25	16,4	5	009000170
14	19,3	25	17,9	5	009000171



900MB/SB12
4-5-5-5-6-7-8-9-10
11-12-13-14 mm

1 009000179

900L

hexagon hand sockets, long series



UNI/ISO 2725 DIN 3124

Ø	L	Ø1			
mm	mm	mm			
4	6,5	50	12,0	5	009000181
4,5	7,0	50	12,0	5	009000182
5	7,5	50	12,0	5	009000183
5,5	8,5	50	12,0	5	009000184
6	9,5	50	12,0	5	009000185
7	10,5	50	12,0	5	009000186
8	12,0	50	12,0	5	009000187
9	13,0	50	13,0	5	009000188
10	14,0	50	14,0	5	009000189
11	16,0	50	16,0	5	009000190
12	17,5	50	17,5	5	009000191
13	17,5	50	17,5	5	009000192
14	20,0	50	20,0	5	009000193



900L/SB13
4-4,5-5-5,5-6-7-8-9-10-11-12-13-14 mm

1 009000203

900MB/L

bi-hex hand sockets, long series



UNI/ISO 2725 DIN 3124

Ø	L	Ø1			
mm	mm	mm			
5	8,0	50	12,0	3	009000211
6	9,3	50	12,0	3	009000212
7	10,9	50	12,0	3	009000213
8	11,6	50	12,0	3	009000214
9	13,0	50	12,0	3	009000215
10	14,3	50	12,8	3	009000216
11	16,0	50	14,2	3	009000217
12	17,4	50	15,5	3	009000218
13	18,0	50	16,2	3	009000219
14	19,0	50	17,1	3	009000220

900AS

hexagon hand sockets



Ø	L	Ø1			
mm	mm	mm			
5/32	8,8	25	11,9	5	009000349
3/16	7,7	25	11,9	5	009000340
7/32	8,8	25	11,9	5	009000345
1/4	9,6	25	11,9	5	009000350
9/32	10,2	25	11,9	5	009000355
5/16	11,3	25	11,9	5	009000360
11/32	12,7	25	11,6	5	009000365
3/8	14,0	25	12,9	5	009000370
7/16	15,3	25	14,5	5	009000375
1/2	17,5	25	16,4	5	009000380
9/16	19,0	25	17,9	5	009000385



900AS/SB11
3/16-7/32-5/32-1/4-9/32-5/16-11/32-3/8-
7/16-1/2-9/16

1 009000389

900AS/MB

bi-hex hand sockets



SAE AS 954E

Ø	L	Ø1			
mm	mm	mm			
3/16	7,7	22	10,9	2	009000390
7/32	8,5	22	10,9	2	009000391
1/4	9,4	22	10,9	2	009000392
9/32	10,2	22	10,9	2	009000393
5/16	11,3	22	11,7	2	009000394
11/32	12,5	22	12,0	2	009000395
3/8	13,7	22	12,9	2	009000396
7/16	15,6	22	14,3	2	009000397
1/2	17,2	22	16,4	2	009000398
9/16	18,8	24	17,9	2	009000399

900AS/L

hexagon hand sockets, long series



SAE AS 954E

Ø	L	Ø1			
mm	mm	mm			
3/16	7,0	50	12,0	2	009000301
7/32	8,5	50	12,0	2	009000303
1/4	9,8	50	12,0	2	009000305
9/32	10,5	50	12,0	2	009000307
5/16	12,0	50	12,0	2	009000309
11/32	13,0	50	13,0	2	009000311
3/8	14,0	50	14,0	2	009000313
7/16	16,0	50	16,0	2	009000315
1/2	17,5	50	17,5	2	009000317
9/16	20,0	50	20,0	2	009000319

900AS/MBL

bi-hex hand sockets, long series



Ø	L	Ø1			
mm	mm	mm			
5/32	6,8	50	12,0	2	009000325
3/16	8,0	50	12,0	2	009000326
7/32	8,5	50	12,0	2	009000327
1/4	9,8	50	12,0	2	009000328
9/32	10,9	50	12,0	2	009000329
5/16	11,6	50	12,0	2	009000330
11/32	13,0	50	12,0	2	009000331
3/8	14,3	50	12,8	2	009000332
7/16	16,0	50	14,2	2	009000333
1/2	18,0	50	16,2	2	009000334
9/16	19,0	50	17,1	2	009000335



900U

gear lock hand sockets

1/4"



mm	"	⊘	⊘		
4	5/32	E5	M5	5	009001702
4,5	3/16	E6		5	009001703
5	13/64		M6	5	009001704
5,5	7/32	E7		5	009001705
6	1/4	E8	M8	5	009001706
7	9/32			5	009001707
8	5/16	E10	M10	5	009001708
9	11/32			5	009001709
10	3/8	E12	M12	5	009001710
11	7/16	E14	M14	5	009001711
12	15/32	E16		5	009001712
13	1/2		M16	5	009001713
14	9/16	E18	M18	5	009001714

1/4"



900U/SB13 1 009001750
4-4,5-5-5,5-6-7-8-9
10-11-12-13-14 mm

900FTX

hand sockets for Torx® head screws

1/4"



⊘	L	Ø1		
mm	mm	mm		
E4	5,4	22	11,2	5 009000404
E5	6,7	22	11,2	5 009000405
E6	7,7	22	11,2	5 009000406
E7	8,3	22	11,2	5 009000407
E8	9,6	22	11,2	5 009000408
E10	11,3	22	12,0	5 009000410
E11	12,1	22	12,5	5 009000411
E12	12,9	23	12,9	5 009000412
E14	14,0	25	14,0	5 009000414

1/4"



900FTX/SB9 1 009000419
E4-E5-E6-E7-E8
E10-E11-E12-E14

900LP

socket drivers for slotted head screws

1/4"



SxA	Ø	L	L1		
mm	mm	mm	mm		
0,8x4	12	28	9	5	009000605
1x5,5	12	28	9	5	009000610
1,2x6,5	12	28	9	5	009000615
1,2x8	13	28	8	5	009000620
1,6x10	14	28	8	5	009000625

900MC/LP

socket drivers for slotted head screws, coloured



SxA	Ø	L	L1		
mm	mm	mm	mm		
0,8x4	12	28	9	3	009002605
1,2x6,5	12	28	9	3	009002615
1,2x8	13	28	8	3	009002620

900PH

socket drivers for cross head Phillips® screws

1/4"



PH	Ø	L	L1		
	mm	mm	mm		
1	12	28	12	5	009000701
2	12	28	12	5	009000702
3	12	28	12	5	009000703
4	13	28	11	5	009000704

1/4"



900PH/SB4 1 009000708
PH1-PH2-PH3-PH4

900MC/PH

socket drivers for cross head Phillips® screws, coloured

1/4"



PH	Ø	L	L1		
	mm	mm	mm		
1	12	28	12	3	009002701
2	12	28	12	3	009002702
3	12	28	12	3	009002703

900PZ

socket drivers for cross head Pozidriv®-Supadriv® screws

1/4"



PZ	Ø	L		
	mm	mm		
1	12	28	3	009000711
2	12	28	3	009000712
3	12	28	3	009000713

900ME

socket drivers for hexagon screws

1/4"



mm	Ø	L	L1		
	mm	mm	mm		
2,5	12	25	4,5	5	009000502
3	12	25	5,0	5	009000503
4	12	25	5,6	5	009000504
5	12	25	6,3	5	009000505
6	12	25	7,6	5	009000506
7	13	25	7,2	5	009000507
8	13	25	8,0	5	009000508
10	13	25	8,7	5	009000510

1/4"



900ME/SB8 1 009000518
2,5-3-4-5-6-7-8-10 mm

900PE/AS

socket drivers for hexagon screws

1/4"



"	Ø	L		
	mm	mm		
1/8	11,9	25	5	009000521
5/32	11,9	25	5	009000522
3/16	11,9	25	5	009000523
7/32	11,9	25	5	009000524
1/4	11,9	25	5	009000525
9/32	13,1	25	5	009000526
5/16	13,	25	5	009000527

900PT

socket drivers for 5-star head screws



	Ø mm	L mm	L1 mm		
PT10	12	28	12	5	009000750
PT15	12	28	12	5	009000755
PT20	12	28	12	5	009000760
PT25	12	28	12	5	009000765
PT27	12	28	12	5	009000767
PT30	12	28	12	5	009000770

900TX

socket drivers for Torx® head screws



	Ø mm	L mm	L1 mm		
T6	12	28	12	5	009000717
T7	12	28	12	5	009000718
T8	12	28	12	5	009000719
T9	12	28	12	5	009000720
T10	12	28	12	5	009000721
T15	12	28	12	5	009000722
T20	12	28	12	5	009000723
T25	12	28	12	5	009000724
T27	12	28	12	5	009000725
T30	12	28	12	5	009000726
T40	12	28	12	5	009000727



900TX/SB8		
T9-T10-T15-T20	1	009000730
T25-T27-T30-T40		

900MC/TX

socket drivers for Torx® head screws, coloured



	Ø mm	L mm	L1 mm		
T10	12	28	12	3	009002721
T15	12	28	12	3	009002722
T20	12	28	12	3	009002723
T25	12	28	12	3	009002724
T27	12	28	12	3	009002725
T30	12	28	12	3	009002726
T40	12	28	12	3	009002727

900/16

adaptor, 1/4" female and 3/8" male drives

1/4"



UNI/ISO 3316 DIN 3123

L mm	Ø mm	1/4"	3/8"		
28	13,0	1/4	3/8	5	009000814

900/...

1/4" female and male drive extension bars

1/4"

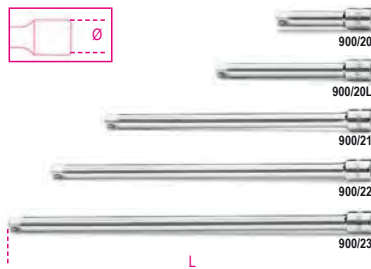

UNI/ISO 3316 DIN 3123

	L mm	Ø mm		
900/20	50	11,5	5	009000818
900/20L	100	11,5	5	009000819
900/21	150	11,5	5	009000822
900/22	250	11,5	5	009000823
900/23	350	11,5	5	009000824

900AN

1/4" wobble extension bars

1/4"

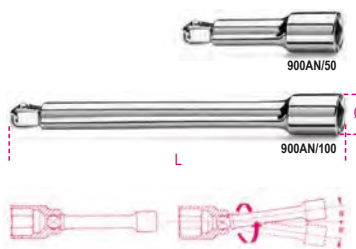

	L mm	Ø mm		
900AN/50	50	11,5	3	009000825
900AN/100	100	11,5	3	009000826

900FL

1/4" flexible universal extension bar

1/4"

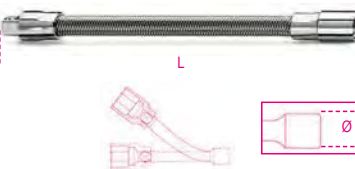

L mm	Ø mm		
150	12	3	009000828

900/25

1/4" drive universal joint

1/4"



UNI/ISO 3316 DIN 3123

L mm	Ø mm		
41	12,5	5	009000830

900BG/30C

1/4" drive spinner handle

1/4"



UNI/ISO 3315 DIN 3122

L mm	L1 mm		
128	20	5	009000833

900BG/30

1/4" drive spinner handle

1/4"



UNI/ISO 3315 DIN 3122

L mm	L1 mm		
176	68	5	009000834

900/32

1/4" drive flexible handle

1/4"



L mm	L1 mm		
280	154	2	009000839

900/35A

1/4" drive swivel handle

1/4"



UNI/ISO 3315 DIN 3122

L mm	L1 mm		
148	84	5	009000840

900M/35

1/4" swivel drive with metal handle



UNI/ISO 3315
DIN 3122
L
mm 130 3 009000845

900/40

1/4" drive swivel T-handle



L L1
mm mm 390 145 3 009000843

900/42

1/4" drive sliding T-handle

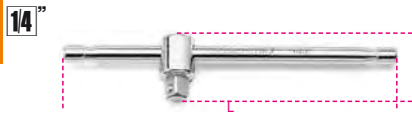

UNI/ISO 3315 DIN 3122
L A
mm mm 115 22 5 009000854

900T/44

1/4" male drive, bent,
with high torque handle



L L1
mm mm 238 105 2 009000860

900/55

1/4" drive reversible ratchet, 48 teeth



UNI/ISO 3315 DIN 3122
L Ø A
mm mm mm 125 25 29 5 009000870

900/55Z

1/4" drive reversible ratchet, 72 tooth
mechanism



L Ø A
mm mm mm 126 25 23 3 009000882

900M/55

1/4" drive reversible ratchet
with metal handle



UNI/ISO 3315
DIN 3122
L Ø A
mm mm mm 110 22 18 3 009000905

Spare parts
rotating mechanism of ratchets,
see table after item 929/C8

900/58

1/4" drive reversible ratchet
with rotating handle,
52 tooth mechanism

- Socket release button
- Ring nut reversal system on ratchet head
- Bi-material handle



L Ø A
mm mm mm 126 28 28,5 2 009000884

900/C39

11 hexagon sockets, 21 bits and 7 accessories



900/C39 1 009000937

- 861LP 0,6x4,5 - 1,2x6,5 - 1,2x8 mm
- 861PH PH1-PH2-PH3
- 861PZ PZ1-PZ2-PZ3
- 861PE 2,5-3-4-5-6 mm
- 861RTX T10-T15-T20-T25-T27-T30-T40
- 900 5-5,5-6-7-8-9-10-11-12-13-14 mm
- 900/20 50 mm
- 900/20L 100 mm
- 900/25
- 900BG/30C 128 mm
- 900/55
- 892/0
- 895/1

900/C11

11 hexagon sockets, 20 bits
and 8 accessories



900/C11 1 009000971

- 861LP 0,5x3 - 0,8x5,5
1x5,5 - 1,2x6,5 mm
- 861PE 3 - 4 - 5 - 6 - 8 mm
- 861PH 0 - 1 - 2 - 3
- 861TX T8 - T10 - T15 - T20
T25 - T30 - T40
- 895/1
- 900 5 - 5,5 - 6 - 7 - 8 - 9 - 10
11 - 12 - 13 - 14 mm
- 900/16 □ 1/4 - ■ 3/8
- 900/20 50 mm
- 900/21 150 mm
- 900/25
- 900BG/30
- 900/42
- 900/55

270x120x45 mm - 1,2 kg

Beta

900/C11Z

11 hexagon sockets,
20 bits and 8 accessories

1/4"



900/C11Z

1 009000984

	861LP	0,5x3 - 0,8x5,5 - 1x5,5 - 1,2x6,5 mm
	861PE	3 - 4 - 5 - 6 - 8 mm
	861PH	0 - 1 - 2 - 3
	861TX	T8 - T10 - T15 - T20 T25 - T30 - T40
	895/1	
	900	5 - 5,5 - 6 - 7 - 8 - 9 - 10 11 - 12 - 13 - 14 mm
	900/16	□ 1/4 - ■ 3/8
	900/20	50 mm
	900/21	150 mm
	900/25	
	900BG/30	
	900/42	
	900/55Z	

≡ 350x150x50 mm - 1,2 kg

900/C12MZ

12 hexagon sockets,
20 bits and 7 accessories
in foam tray

1/4"



900/C12MZ

1 009000983

	900	4-5-5,5-6-7-8-9-10-11-12-13-14 mm
	900/20	50 mm
	900/21	150 mm
	900/25	
	900/42	115 mm
	900BG/30	128 mm
	900/55Z	
	895/1	
	861TX	T8-T10-T15-T20-T25-T30-T40
	861PH	PH0-PH1-PH2-PH3
	861LP	0,5x3 - 0,8x5,5 - 1x5,5 - 1,2x6,5 mm
	861PE	3-4-5-6-8 mm

≡ 350x150x50 mm - 1,2 kg

900/C13-5

13 hexagon sockets and 5 accessories

1/4"



900/C13-5

1 009000953

	900	4 - 4,5 - 5 - 5,5 - 6 - 7 - 8 - 9 10 - 11 - 12 - 13 - 14 mm
	900/21	150 mm
	900/25	
	900BG/30	
	900/42	
	900/55	

≡ 270x120x45 mm - 1 kg

900/C13-8

13 hexagon sockets and 8 accessories

1/4"



900/C13-8

1 009000954

	900	4 - 4,5 - 5 - 5,5 - 6 - 7 - 8 - 9 10 - 11 - 12 - 13 - 14 mm
	900/16	□ 1/4 - ■ 3/8
	900/20	50 mm
	900/21	150 mm
	900/25	
	900BG/30	
	900/35A	
	900/42	
	900/55	

≡ 270x120x45 mm - 1,1 kg

900MB/C19

11 bi-hex sockets and 8 accessories

1/4"



900MB/C19

1 009000977

	900MB	5 - 5,5 - 6 - 7 - 8 - 9 - 10 - 11 12 - 13 - 14 mm
	900/16	□ 1/4 - ■ 3/8
	900/20	50 mm
	900/21	150 mm
	900/25	
	900BG/30	
	900/35A	
	900/42	
	900/55	

≡ 270x120x45 mm - 1,1 kg

900/C24

13 hexagon sockets, 11 socket drivers
and 6 accessories

1/4"



900/C24

1 009000956

	900	4 - 4,5 - 5 - 5,5 - 6 - 7 - 8 - 9 10 - 11 - 12 - 13 - 14 mm
	900LP	0,8x4 - 1,2x6,5 - 1,2x8 mm
	900PH	PH1 - PH2 - PH3
	900ME	3 - 4 - 5 - 6 - 8 mm
	900/20	50 mm
	900/21	150 mm
	900/25	
	900BG/30	
	900/42	
	900/55	

≡ 270x120x45 mm - 1,1 kg



900MC/C24

11 hexagon sockets, 13 coloured socket drivers and 6 accessories

1/4"



900MC/C24

1 009002960

	900MC	4 - 5 - 6 - 7 - 8 - 9 10 - 11 - 12 - 13 - 14 mm
	900MC/PH	PH1 - PH2 - PH3
	900MC/TX	T10 - T15 - T20 - T25 - T27 - T30 - T40
	900MC/LP	0,8x4 - 1,2x6,5 - 1,2x8 mm
	900/20	50 mm
	900/21	150 mm
	900/25	
	900BG/30	
	900/42	
	900/55	

270x120x45 mm - 1 kg

900MB/C28

11 bi-hex sockets, 11 socket drivers and 6 accessories

1/4"



900MB/C28

1 009000979

	900MB	5 - 5,5 - 6 - 7 - 8 - 9 - 10 - 11 12 - 13 - 14 mm
	900LP	0,8x4 - 1,2x6,5 - 1,2x8 mm
	900PH	PH1 - PH2 - PH3
	900ME	3 - 4 - 5 - 6 - 8 mm
	900/20	50 mm
	900/21	150 mm
	900/25	
	900BG/30	
	900/42	
	900/55	

270x120x45 mm - 1,1 kg

900MC/C32

11 coloured sockets, 20 coloured bits and 7 accessories

1/4"



900MC/C32

1 009002963

	900MC	4 - 5 - 6 - 7 - 8 - 9 - 10 - 11 - 12 - 13 - 14 mm
	860LP	0,5x3 - 0,8x5,5 - 1,0x5,5 - 1,2x6,5 mm
	860PH	0 - 1 - 2 - 3
	860PE	3 - 4 - 5 - 6 - 8 mm
	860TX	T8 - T10 - T15 - T20 - T25 - T30 - T40
	895/1	
	900/20	
	900/21	
	900/25	
	900BG/30	
	900/42	
	900/55	

270x120x45 mm - 1,2 kg

900AS/C10 - /MB-C17

10 sockets and 7 accessories

1/4"



900AS/C10

1 009000961

	900AS	3/16 - 7/32 - 1/4 - 9/32 - 5/16 11/32 - 3/8 - 7/16 - 1/2 - 9/16
	900/20	50 mm
	900/21	150 mm
	900/25	
	900BG/30	
	900/35A	
	900/42	
	900/55	

270x120x45 mm - 1,1 kg

900AS/MB-C17

1 009000981

	900AS/MB	3/16 - 7/32 - 1/4 - 9/32 - 5/16 11/32 - 3/8 - 7/16 - 1/2 - 9/16
	900/20	50 mm
	900/21	150 mm
	900/25	
	900BG/30	
	900/35A	
	900/42	
	900/55	

270x120x45 mm - 1,1 kg

900AS/C17-MBM

10 bi-hex sockets and 7 accessories for aeronautical maintenance

1/4"



900AS/C17-MBM

1 009000982

	900AS/MB	3/16 - 7/32 - 1/4 - 9/32 - 5/16 11/32 - 3/8 - 7/16 - 1/2 - 9/16
	900/20	50 mm
	900/21	150 mm
	900/25	
	900BG/30	
	900M/35	
	900/42	
	900M/55	

270x120x45 mm - 1,2 kg

900/C11HR

11 hexagon sockets, 20 bits and 7 accessories in hard foam tray, in metal case

• ratchet with rotating handle

1/4"

1/4"



900/C11HR

1 009000980

	861LP	0,5x3-0,8x5,5-1x5,5-1,2x6,5 mm
	861PH	PH0-PH1-PH2-PH3
	861PE	3-4-5-6-8 mm
	861TX	T8-T10-T15-T20-T25-T30-T40
	895/1	
	900	5-5,5-6-7-8-9-10-11-12-13-14 mm
	900/16	□ 1/4 - ■ 3/8
	900/20	50 mm
	900/21	150 mm
	900/25	
	900/42	
	900BG/30	
	900/58	

350x150x50 mm - 1,3 kg

902R/C6

6 adapters for socket drivers



902R/C6

1 009020814

	900/16	□ 1/4 - ■ 3/8
	910/15	□ 3/8 - ■ 1/4
	910/16	□ 3/8 - ■ 1/2
	920/15	□ 1/2 - ■ 3/8
	920/16	□ 1/2 - ■ 3/4
	928/15	□ 3/4 - ■ 1/2

170x100x35 mm - 600 g

910A

hexagon hand sockets



UNI/ISO 2725 DIN 3124

mm	Ø	L	Ø1	
6	9,5	28	16,7	5 009100006
7	10,7	28	16,7	5 009100007
8	12,1	28	16,7	5 009100008
9	13,2	28	16,7	5 009100009
10	14,6	29	16,7	5 009100010
11	15,8	29	16,7	5 009100011
12	17,2	30	17,7	5 009100012
13	18,4	31	17,0	5 009100013
14	19,7	32	17,5	5 009100014
15	20,9	32	18,0	5 009100015
16	22,2	33	18,5	5 009100016
17	23,2	33	19,0	5 009100017
18	24,7	34	20,0	5 009100018
19	25,8	35	21,0	5 009100019
20	27,2	35	22,0	5 009100020
21	28,2	36	23,0	5 009100021
22	29,7	37	24,0	5 009100022



910A/SB17

6-7-8-9-10-11-12
13-14-15-16-17
18-19-20-21-22 mm

1 009100030

910B

bi-hex hand sockets



UNI/ISO 2725 DIN 3124

mm	Ø	L	Ø1	
6	9,5	28	16,7	5 009100106
7	10,7	28	16,7	5 009100107
8	12,1	28	16,7	5 009100108
9	13,2	28	16,7	5 009100109
10	14,6	29	16,7	5 009100110
11	15,8	29	16,7	5 009100111
12	17,2	30	17,7	5 009100112
13	18,4	31	17,0	5 009100113
14	19,7	32	17,5	5 009100114
15	20,9	32	18,0	5 009100115
16	22,2	33	18,5	5 009100116
17	23,2	33	19,0	5 009100117
18	24,7	34	20,0	5 009100118
19	25,8	35	21,0	5 009100119
20	27,2	35	22,0	5 009100120
21	28,2	36	23,0	5 009100121
22	29,7	37	24,0	5 009100122



910B/SB17

6-7-8-9-10-11-12
13-14-15-16-17
18-19-20-21-22 mm

1 009100130

910AL

hexagon hand sockets,
long series



UNI/ISO 2725 DIN 3124

mm	Ø	L	Ø1	
8	12,0	55	17	3 009100158
9	13,0	55	17	3 009100159
10	14,5	55	17	3 009100160
11	16,0	55	17	3 009100161
12	17,0	55	17	3 009100162
13	18,0	55	17	3 009100163
14	20,0	55	18	3 009100164
15	21,0	55	20	3 009100165
16	22,0	55	20	3 009100166
17	23,5	55	22	3 009100167
18	24,5	55	23	2 009100168
19	25,0	55	24	2 009100169
21	27,0	65	26	2 009100171
22	29,0	65	28	2 009100172



910AL/SB14

8-9-10-11-12-13-14
15-16-17-18-19-21-22 mm

1 009100174

910BL

bi-hex hand sockets, long series



UNI/ISO 2725 DIN 3124

mm	Ø	L	Ø1	
8	12,0	55	17	3 009100308
9	13,0	55	17	3 009100309
10	14,5	55	17	3 009100310
11	16,0	55	17	3 009100311
12	17,0	55	17	3 009100312
13	18,0	55	17	3 009100313
14	20,0	55	18	3 009100314
15	21,0	55	20	3 009100315
16	22,0	55	20	3 009100316
17	23,5	55	22	3 009100317
18	24,5	55	23	2 009100318
19	25,0	55	24	2 009100319
21	27,0	65	26	2 009100321
22	29,0	65	28	2 009100322



910BL/SB14

8-9-10-11-12-13
14-15-16-17-18
19-21-22 mm

1 009100340

910B/SN

swivel end bi-hex hand sockets



mm	Ø	L	Ø1	
10	14,5	48,5	19	2 009100230
11	15,8	49,5	19	2 009100231
12	17,0	50,0	19	2 009100232
13	18,3	51,0	19	2 009100233
14	19,5	51,0	19	2 009100234
15	20,8	53,5	19	2 009100235
16	22,0	53,5	19	2 009100236
17	23,3	54,5	19	2 009100237
18	24,5	54,5	19	2 009100238
19	25,8	56,5	19	2 009100239

910A/AS

hexagon hand sockets



mm	Ø	L	Ø1	
1/4	10,3	26	17,3	5 009100276
5/16	11,9	26	17,3	5 009100278
11/32	13,3	26	17,3	5 009100279
3/8	13,9	26	17,3	5 009100280
7/16	15,8	26	17,3	5 009100281

"	Ø mm	L mm	Ø1 mm		
1/2	17,9	26	17,3	5	009100283
9/16	19,5	27	18,5	5	009100284
19/32	20,6	27	19,5	5	009100285
5/8	21,9	28	20,0	5	009100286
11/16	24,6	30	22,5	5	009100287
3/4	25,9	30	23,5	5	009100289
13/16	27,9	32	26,0	5	009100291
7/8	29,6	32	26,5	5	009100292



910A-AS/SB13					
1/4-5/16-11/32-3/8-7/16					
1/2-9/16-19/32-5/8-11/16					
3/4-13/16-7/8					

910AS bi-hex hand sockets



"	Ø mm	L mm	Ø1 mm		
1/4	9,5	28	16,7	5	009100201
5/16	12,1	28	16,7	5	009100202
11/32	13,2	28	16,7	5	009100203
3/8	14,6	29	16,7	5	009100204
7/16	15,8	29	16,7	5	009100205
1/2	18,4	31	17,0	5	009100206
9/16	19,7	32	17,5	5	009100207
19/32	20,9	32	18,0	5	009100208
5/8	22,2	33	18,5	5	009100209
11/16	24,7	34	20,0	5	009100210
3/4	25,8	35	21,0	5	009100211
13/16	28,2	36	23,0	5	009100212
7/8	29,7	37	24,0	5	009100213



910AS/SB13					
1/4-5/16-11/32-3/8-7/16					
1/2-9/16-19/32-5/8-11/16					
3/4-13/16-7/8					

910AS/L bi-hex hand sockets, long series



"	Ø mm	L mm	Ø1 mm		
1/4	10	55	17	3	009100350
5/16	12	55	17	3	009100351
3/8	14	55	17	3	009100352
7/16	16	55	17	3	009100353
1/2	18	55	17	3	009100354
9/16	20	55	18	3	009100355
19/32	21	55	20	3	009100356
5/8	22	55	20	3	009100357
11/16	23	55	22	3	009100359
3/4	25	55	24	3	009100360
13/16	27	65	26	3	009100362
7/8	29	65	28	3	009100363



910ASL/SB12					
1/4-5/16-3/8-7/16					
1/2-9/16-19/32-5/8-11/16					
3/4-13/16-7/8					

910AS/SN swivel end bi-hex hand sockets

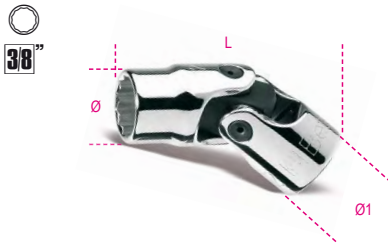

* SAE AS 954E

"	Ø mm	L mm	Ø1 mm		
* 3/8	14,0	48,0	19	2	009100260
* 7/16	15,8	51,0	19	2	009100261
* 1/2	18,3	51,0	19	2	009100262
* 9/16	19,5	51,0	19	2	009100263
* 5/8	22,0	53,5	19	2	009100264
11/16	24,5	54,5	19	2	009100265
3/4	25,8	56,5	19	2	009100266

910FTX hand sockets for Torx® head screws



"	Ø mm	L mm	Ø1 mm		
E4	6,2	26	17,3	5	009100404
E5	7,0	26	17,3	5	009100405
E6	8,3	26	17,3	5	009100406
E7	8,9	26	17,3	5	009100407
E8	9,9	26	17,3	5	009100408
E10	12,0	26	17,3	5	009100410
E11	13,3	26	17,3	5	009100411
E12	14,5	26	17,3	5	009100412
E14	15,8	26	17,3	5	009100414
E16	18,0	26	17,3	5	009100416
E18	19,5	26	18,5	3	009100418
E20	21,9	26	20,0	3	009100420



910FTX/SB9					
E4-E5-E6-E7-E8					
E10-E12-14-E16					

910FTX/L hand sockets for Torx® head screws, long series



"	Ø mm	L mm	Ø1 mm		
E4	6,2	55	17,3	3	009100440
E5	7,0	55	17,3	3	009100441
E6	8,3	55	17,3	3	009100442
E7	8,9	55	17,3	3	009100443
E8	9,9	55	17,3	3	009100444
E10	12,0	55	17,3	3	009100445



910FTX-L/SB6					
E4-E5-E6					
E7-E8-E10					

910FTX/XL hexagon hand sockets for Torx® head screws, extra-long series



"	Ø mm	L mm	Ø1 mm		
E6	8,0	200	18	2	009100766
E7	8,0	200	18	2	009100767
E8	10,0	200	18	2	009100768
E10	14,0	200	18	2	009100770
E11	14,0	200	18	2	009100771
E12	14,0	200	18	2	009100772
E14	17,0	200	18	2	009100774
E16	18,6	200	18	2	009100776
E18	21,5	200	18	2	009100778
E20	21,5	200	18	2	009100780

910FTX-XL/C10 set of 10 hand sockets for Torx® head screws, long series, in plastic case



910FTX-XL/C10					
E6-E7-E8-E10-E11-					
E12-E14-E16-E18-E20					

255x195x62 mm - 2,3 kg

910LP

socket drivers for slotted head screws



SxA	Ø	L	L1		
mm	mm	mm	mm		
1x5,5	18,5	54	24	2	009100452
1,2x6,5	18,5	54	24	2	009100453
1,2x8	18,5	54	24	2	009100454
1,6x9	18,5	54	24	2	009100456

910PH

socket drivers for cross head Phillips® screws

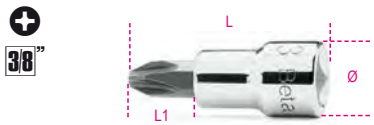

PH	Ø	L	L1		
	mm	mm	mm		
1	18,5	48	18	2	009100471
2	18,5	48	18	2	009100472
3	18,5	48	18	2	009100473
4	18,5	48	18	2	009100474



910PH/SB4		
PH1-PH2-PH3-PH4	1	009100478

910PE

socket drivers for hexagon screws



DIN 7422

mm	Ø	L	L1		
	mm	mm	mm		
3	18,5	50	20	5	009100490
4	18,5	50	20	5	009100492
5	18,5	50	20	5	009100494
6	18,5	50	20	5	009100496
7	18,5	50	20	5	009100497
8	18,5	50	20	5	009100498
9	18,5	50	20	5	009100499
10	18,5	50	20	5	009100500



910PE/SB7		
3-4-5-6-7-8-10 mm	1	009100503

910BP

ball head socket drivers for hexagon screws



mm	L	L1		
mm	mm	mm		
4L	92	62	3	009100584
5L	92	62	3	009100585
6L	92	62	3	009100586
7L	92	62	3	009100587
8L	92	62	3	009100588
10L	132	102	3	009100590



910BP/SB6L		
4L-5L-6L-7L-8L-10L mm	1	009100596

910ME

socket drivers for hexagon screws



mm	Ø	L	L1		
	mm	mm	mm		
4	18	62	15	5	009100504
5	18	62	15	5	009100505
6	18	62	15	5	009100506
7	18	62	15	5	009100507
8	19	62	15	5	009100508
10	20	62	15	5	009100510
12	20	62	15	5	009100512



910ME/SB5		
4-5-6-8-10 mm	1	009100515

910PE/AS

socket drivers for hexagon screws



"	Ø	L	L1		
	mm	mm	mm		
1/8	18,5	50	20	2	009100531
5/32	18,5	50	20	2	009100532
3/16	18,5	50	20	2	009100533
7/32	18,5	50	20	2	009100534
1/4	18,5	50	20	2	009100535
5/16	18,5	50	20	2	009100536
3/8	18,5	50	20	2	009100537

910PT

socket drivers for 5-star head screws

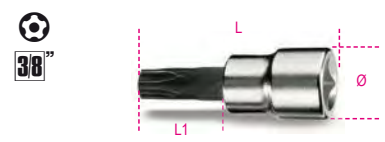

PT	Ø	L	L1		
	mm	mm	mm		
PT40	20	50	20	3	009100540
PT45	20	50	20	3	009100545
PT50	20	50	20	3	009100550



910PT/SB8		
PT10-PT15-PT20-PT25 PT30-PT40-PT45-PT50	1	009100558

910TX

socket drivers for Torx® head screws



T	Ø	L	L1		
	mm	mm	mm		
T15	18,5	50	20	5	009100519
T20	18,5	50	20	5	009100520
T25	18,5	50	20	5	009100521
T27	18,5	50	20	5	009100522
T30	18,5	50	20	5	009100523
T40	18,5	50	20	5	009100524
T45	18,5	50	20	3	009100525
T50	18,5	50	20	3	009100526



910TX/SB6		
T15-T20-T25 T27-T30-T40	1	009100530

910XZN

socket drivers with XZN® profile



M	L		
	mm		
M4	50	3	009100559
M5	50	3	009100560
M6	50	3	009100561
M8	50	3	009100563
M10	50	3	009100565

910CF

3/8" square drive crowfoot wrenches

3/8"



mm	A mm	L mm		
10	21,3	32,3	2	009100135
11	23,1	34,3	2	009100136
12	25,5	36,2	2	009100137
13	26,9	37,4	2	009100138
14	30,2	40,0	2	009100139
15	33,3	41,3	2	009100140
16	33,3	41,3	2	009100141
17	38,1	46,5	2	009100142
18	38,1	46,5	2	009100143
19	39,6	48,0	2	009100144

3/8"



910CF/SB10			
10-11-12-13-14-15		1	009100147
16-17-18-19 mm			

910/15

adaptor, 3/8" female and 1/4" male drivers

3/8"



UNI/ISO 3316 DIN 3123

L mm	Ø mm		
30	17,0	3/8	1/4



Always apply torque loads evenly and progressively to avoid breakage and any possible injury.

910/16

adaptor, 3/8" female and 1/2" male drives

3/8"



UNI/ISO 3316 DIN 3123

L mm	Ø mm		
32	18,0	3/8	1/2



910/20 - 910/21 - 910/22

3/8" drive extension bars

3/8"



UNI/ISO 3316 DIN 3123

	L mm	Ø mm		
910/20	75	17	5	009100820
910/21	125	17	5	009100822
910/22	250	17	5	009100826

910AN

3/8" wobble extension bars

3/8"

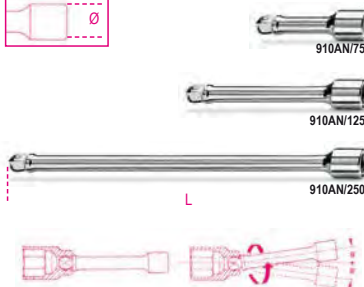

	L mm	Ø mm		
910AN/75	75	17	3	009100827
910AN/125	125	17	3	009100828
910AN/250	250	17	3	009100829

910/25

3/8" drive universal joint

3/8"



UNI/ISO 3316 DIN 3123

L mm	Ø mm		
54,6	19	5	009100830

910M/35

3/8" swivel drive with metal handle

3/8"



UNI/ISO 3315 DIN 3122

L mm			
250	3	009100839	

910/36A

3/8" drive swivel handle

3/8"



UNI/ISO 3315 DIN 3122

L mm	L1 mm		
255	154	3	009100845

910/40

3/8" drive swivel T-handle

3/8"



L mm	L1 mm		
420	175	3	009100850

910/42

3/8" drive sliding T-handle

3/8"



UNI/ISO 3315 DIN 3122

L mm	A mm		
210	30,5	5	009100854

910/46

3/8" square drive with speed brace

3/8"

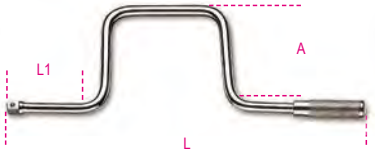

UNI/ISO 3315 DIN 3122

L mm	L1 mm	A mm		
315	80	115	1	009100862

910/55

3/8" drive reversible ratchet 72 teeth

72

3/8"



UNI/ISO 3315 DIN 3122

L mm	Ø mm	A mm		
200	30	33	3	009100882



910/55Q

3/8" drive reversible ratchet 48 teeth



UNI/ISO 3315 DIN 3122

L	Ø	A		
mm	mm	mm		
200	30	33	3	009100885

**Spare parts
rotating mechanism of ratchets,
see table after item 929/C8**

910M/55

3/8" drive reversible ratchet
with metal handle



DIN 3122 - UNI ISO 3315

L	Ø	A		
mm	mm	mm		
178	30	26	2	009100875

910M/56

3/8" drive reversible swivel ratchet
with metal handle



L	Ø	A		
mm	mm	mm		
265	31	29	2	009100887

910/58

3/8" drive reversible ratchet
with rotating handle,
52 tooth mechanism

- Socket release button
- Ring nut reversal system on ratchet head
- Bi-material handle



L	Ø	A		
mm	mm	mm		
222	37	38,5	1	009100884

910.../C10

10 sockets and 2 accessories



910A/C10 1 009100909

	910A	6 - 7 - 8 - 10 - 11 - 12 13 - 14 - 17 - 19 mm
	910/21	125 mm
	910/55	
≡ 270x120x45 mm - 1,3 kg		

910B/C10 1 009100910

	910B	6 - 7 - 8 - 10 - 11 - 12 13 - 14 - 17 - 19 mm
	910/21	125 mm
	910/55	
≡ 270x120x45 mm - 1,3 kg		

910A/C16...

16 hexagon sockets and 5 accessories



910A/C16 1 009100936

	910A	6 - 7 - 8 - 9 - 10 - 11 - 12 - 13 14 - 15 - 16 - 17 - 18 - 19 21 - 22 mm
	910/21	125 mm
	910/22	250 mm
	910/25	
	910/42	
	910/55	
≡ 335x145x60 mm - 2,3 kg		

910A/C16Q 1 009100932

	910A	6 - 7 - 8 - 9 - 10 - 11 - 12 - 13 14 - 15 - 16 - 17 - 18 - 19 21 - 22 mm
	910/21	125 mm
	910/22	250 mm
	910/25	
	910/42	
	910/55Q	
≡ 335x145x60 mm - 2,3 kg		

910B/C16...

16 bi-hex sockets and 5 accessories



910B/C16 1 009100937

	910B	6 - 7 - 8 - 9 - 10 - 11 - 12 - 13 14 - 15 - 16 - 17 - 18 - 19 21 - 22 mm
	910/21	125 mm
	910/22	250 mm
	910/25	
	910/42	
	910/55	
≡ 335x145x60 mm - 2,3 kg		

910B/C16Q 1 009100933

	910B	6 - 7 - 8 - 9 - 10 - 11 - 12 - 13 14 - 15 - 16 - 17 - 18 - 19 21 - 22 mm
	910/21	125 mm
	910/22	250 mm
	910/25	
	910/42	
	910/55Q	
≡ 335x145x60 mm - 2,3 kg		

910A/C17

17 hexagon sockets and 9 accessories



910A/C17 1 009100938

	910A	6 - 7 - 8 - 9 - 10 - 11 - 12 - 13 14 - 15 - 16 - 17 - 18 - 19 - 20 21 - 22 mm
	910/15	□ 3/8 - ■ 1/4
	910/16	□ 3/8 - ■ 1/2
	910/21	125 mm
	910/22	250 mm
	910/25	
	910/36A	
	910/42	
	910/46	
	910/55	
≡ 420x280x60 mm - 4,0 kg		

910.../C29

17 sockets, 12 socket drivers
and 5 accessories

38"



910A/C29 1 009100944

- 910A 6 - 7 - 8 - 9 - 10 - 11 - 12 - 13
14 - 15 - 16 - 17 - 18 - 19 - 20
21 - 22 mm
- 910LP 1x5,5 - 1,2x6,5 - 1,2x8 mm
- ⊕ 910PH PH1 - PH2 - PH3
- 910PE 3 - 4 - 5 - 6 - 8 - 10 mm
- 910/21 125 mm
- 910/22 250 mm
- 910/25
- 910/42
- 910/55

420x185x60 mm - 3,5 kg

910B/C29 1 009100945

- 910B 6 - 7 - 8 - 9 - 10 - 11 - 12 - 13
14 - 15 - 16 - 17 - 18 - 19 - 20
21 - 22 mm
- 910LP 1x5,5 - 1,2x6,5 - 1,2x8 mm
- ⊕ 910PH PH1 - PH2 - PH3
- 910PE 3 - 4 - 5 - 6 - 8 - 10 mm
- 910/21 125 mm
- 910/22 250 mm
- 910/25
- 910/42
- 910/55

420x185x60 mm - 3,5 kg

910AS/C13...

13 bi-hex sockets and 5 accessories

38"



910AS/C13 1 009100925

- 910AS 1/4 - 5/16 - 11/32 - 3/8 - 7/16
1/2 - 9/16 - 19/32 - 5/8 - 11/16
3/4 - 13/16 - 7/8
- 910/21 125 mm
- 910/22 250 mm
- 910/42
- 910/25
- 910/55

335x145x60 mm - 2,3 kg

910AS/MBM-C18

13 bi-hex sockets and 5 accessories
for aeronautical maintenance

38"



910AS/MBM-C18 1 009100926

- 910AS 1/4 - 5/16 - 11/32 - 3/8 - 7/16
1/2 - 9/16 - 19/32 - 5/8 - 11/16
3/4 - 13/16 - 7/8
- 910/21 125 mm
- 910/22 250 mm
- 910/25
- 910/42
- 910M/55

335x145x60 mm - 2,5 kg

910A/C16HR

16 hexagon sockets and 5 accessories

38"



910A/C16HR 1 009100935

- 910A 6 - 7 - 8 - 9 - 10 - 11 - 12 - 13
14 - 15 - 16 - 17 - 18 - 19
21 - 22 mm
- 910/21 125 mm
- 910/22 250 mm
- 910/25
- 910/42 210 mm
- 910/58

335x145x60 mm - 2,4 kg

920A hexagon hand sockets

12"



UNI/ISO 2725 DIN 3124

mm	Ø	L	Ø1	
8	12,4	38	21,7	10 009200008
9	13,5	38	21,7	10 009200009
10	14,9	38	21,7	10 009200010

mm	Ø	L	Ø1	
11	16,1	38	21,7	10 009200011
12	17,5	38	21,7	10 009200012
13	18,7	38	21,7	10 009200013
14	20,1	38	21,7	10 009200014
15	21,5	38	22,5	10 009200015
16	22,7	38	23,7	10 009200016
17	24,1	38	23,1	10 009200017
18	25,3	39	24,0	10 009200018
19	26,6	39	24,0	10 009200019
20	27,8	40	25,0	5 009200020
21	28,8	40	25,0	5 009200021
22	29,9	41	26,0	5 009200022
23	30,8	42	26,0	5 009200023
24	32,2	43	27,0	5 009200024
25	33,2	44	27,0	5 009200025
26	34,7	45	28,0	5 009200026
27	36,2	46	29,0	5 009200027
28	37,2	47	30,0	5 009200028
29	38,6	48	31,0	5 009200029
30	40,2	48	32,0	5 009200030
32	42,3	49	34,0	5 009200032

12"



920A/SB13 1 009200040

10-11-12-13-14-15-16
17-18-19-20-21-22 mm

12"



920A/SB8 1 009200042

23-24-25-26-27-28-30-32 mm

920MC

hexagon hand sockets,
coloured

12"



mm	Ø	L	Ø1	
8	13,2	38	22	5 009202008
10	15,3	38	22	5 009202010
11	16,5	38	22	5 009202011
12	17,8	38	22	5 009202012
13	19,0	38	22	5 009202013
14	20,3	38	22	5 009202014
15	21,6	38	22	5 009202015
16	23,0	38	23	5 009202016
17	23,9	38	24	5 009202017
18	25,0	38	25	5 009202018
19	26,5	38	24	5 009202019
21	28,8	38	27	3 009202021
22	29,9	40	28	3 009202022
24	32,8	40	30	3 009202024

Beta
Quality Tools

920B

bi-hex hand sockets

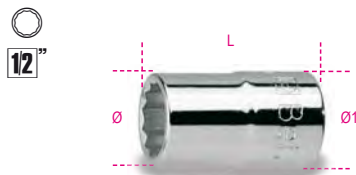

UNI/ISO 2725 DIN 3124

Ø mm	Ø mm	L mm	Ø1 mm	12"	12"
8	12,4	38	21,7	10	009200108
9	13,5	38	21,7	10	009200109
10	14,9	38	21,7	10	009200110
11	16,1	38	21,7	10	009200111
12	17,5	38	21,7	10	009200112
13	18,7	38	21,7	10	009200113
14	20,1	38	21,7	10	009200114
15	21,5	38	22,5	10	009200115
16	22,7	38	23,7	10	009200116
17	24,1	38	23,1	10	009200117
18	25,3	39	24,0	10	009200118
19	26,6	39	24,0	10	009200119
20	27,8	40	25,0	5	009200120
21	28,8	40	25,0	5	009200121
22	29,9	41	26,0	5	009200122
23	30,8	42	26,0	5	009200123
24	32,2	43	27,0	5	009200124
25	33,2	44	27,0	5	009200125
26	34,7	45	28,0	5	009200126
27	36,2	46	29,0	5	009200127
28	37,2	47	30,0	5	009200128
29	38,6	48	31,0	5	009200129
30	40,2	48	32,0	5	009200130
32	42,3	49	33,9	5	009200132



920B/SB13
10-11-12-13-14-15-16
17-18-19-20-21-22 mm

1 009200140



920B/SB8
23-24-25-26-27
28-30-32 mm

1 009200142

920AL

hexagon hand sockets, long series



UNI/ISO 2725 DIN 3124

Ø mm	Ø mm	L mm	Ø1 mm	12"	12"
10	14,7	77	21	5	009200626
12	17,8	77	21	5	009200627
13	19,0	77	22	5	009200628
14	20,3	77	22	5	009200629
15	21,5	77	22	5	009200630
16	22,8	77	22	5	009200631
17	24,0	77	23	5	009200632
18	25,0	77	24	5	009200633
19	26,5	77	25	5	009200634
21	29,0	77	27	5	009200635
22	30,0	77	28	5	009200636
23	31,5	77	29	5	009200637
24	32,8	77	30	5	009200638
27	36,5	77	33	3	009200639
30	40,0	77	36	3	009200640
32	42,8	77	38	3	009200641
36	48,0	77	41	3	009200642



920AL/SB11
10-12-13-14-15-16
17-18-19-21-22 mm

1 009200644

920BL

bi-hex hand sockets, long series

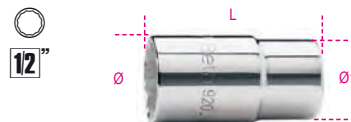

UNI/ISO 2725 DIN 3124

Ø mm	Ø mm	L mm	Ø1 mm	12"	12"
10	14,7	77	21	5	009200310
12	17,8	77	21	5	009200312
13	19,0	77	22	5	009200313
14	20,3	77	22	5	009200314
15	21,5	77	22	5	009200315
16	22,8	77	22	5	009200316
17	24,0	77	23	5	009200317
18	25,0	77	24	5	009200318
19	26,5	77	25	5	009200319
21	29,0	77	27	5	009200321
22	30,0	77	28	5	009200322
23	31,5	77	29	5	009200323
24	32,8	77	30	5	009200324
27	36,5	77	33	3	009200327
30	40,0	77	36	3	009200330
32	42,8	77	38	3	009200332
36	48,0	77	41	3	009200336



920BL/SB11
10-12-13-14-15-16-17-18
19-21-22 mm

1 009200338

920A/AS

hexagon hand sockets



Ø mm	Ø mm	L mm	Ø1 mm	12"	12"
3/8	14,6	37	21	2	009200270
7/16	16,5	37	21	3	009200272
1/2	19,0	37	22	3	009200273
9/16	20,3	37	22	3	009200274
19/32	21,0	37	22	3	009200275
5/8	22,8	37	22	3	009200276
11/16	25,0	37	24	3	009200277
3/4	26,5	38	25	3	009200279
25/32	28,0	38	26	3	009200280
13/16	29,0	38	27	3	009200281
7/8	30,0	40	28	3	009200282
15/16	32,8	42	30	3	009200284
1	35,0	42	32	3	009200285
1.1/16	36,5	43	33	2	009200287
1.1/8	39,0	43	35	2	009200289
1.3/16	41,0	46	36	2	009200290
1.1/4	42,8	46	38	2	009200292



920A-AS/SB11
3/8-7/16-1/2-9/16-5/8
11/16-3/4-13/16-7/8
15/16-1

1 009200295

920AS

bi-hex hand sockets



Ø mm	Ø mm	L mm	Ø1 mm	12"	12"
3/8	14,9	38	21,7	3	009200201
7/16	16,1	38	21,7	3	009200202
1/2	18,7	38	21,7	3	009200203
9/16	20,1	38	21,7	3	009200204
5/8	22,7	38	22,5	3	009200206
19/32	21,5	38	23,7	3	009200207
11/16	25,3	39	24,0	3	009200208
3/4	26,6	39	24,0	3	009200209
25/32	27,8	40	25,0	3	009200210
13/16	28,8	40	25,0	3	009200211
7/8	29,9	41	26,0	3	009200212
15/16	32,2	43	27,0	3	009200214
1	34,2	45	28,0	3	009200216
1.1/16	36,2	46	29,0	2	009200217
1.1/8	38,6	48	31,0	2	009200218
1.3/16	40,2	48	32,0	2	009200219
1.1/4	42,3	49	33,5	2	009200220



920AS/SB11
3/8-7/16-1/2-9/16-5/8
11/16-3/4-13/16-7/8
15/16-1

1 009200225

920AS/L

bi-hex hand sockets, long series



Ø mm	Ø mm	L mm	Ø1 mm	12"	12"
1/2	19,0	77	22	2	009200352
9/16	20,3	77	22	2	009200353
5/8	22,8	77	22	2	009200355
11/16	25,0	77	24	2	009200357
3/4	26,5	77	25	2	009200358
13/16	29,0	77	27	2	009200360
7/8	30,0	77	28	2	009200361
15/16	32,8	77	30	2	009200362
1	35,0	77	32	2	009200363
1.1/16	36,5	77	33,0	2	009200364
1.1/8	37,8	77	34	2	009200365



920ASL/SB11
1/2-9/16-5/8-11/16
3/4-13/16-7/8-15/16
1-1.1/8-1.1/16

1 009200369

920U

gear lock hand sockets

12"



mm	"	Ø	Ø1	L	mm	1	2
10	3/8	E12	M12	38	5	009201710	
11	7/16	E14	M14	38	5	009201711	
12	15/32	E16		38	5	009201712	
13	1/2		M16	38	5	009201713	
14	9/16	E18	M18	38	5	009201714	
15	19/32			38	5	009201715	
16	5/8	E20		38	5	009201716	
17				38	5	009201717	
18		E22		38	5	009201718	
19	3/4	E24		38	5	009201719	
20	25/32			38	3	009201720	
21				38	3	009201721	
22	7/8			38	3	009201722	
24	15/16			38	3	009201724	
27	1.1/16			42	3	009201727	
30	1.1/8			44	3	009201730	
32	1.1/4			44	3	009201732	

12"



920U/SB13	10-11-12-13-14-15-16	1	009201740
	17-18-19-20-21-22 mm		

12"



920U/SB4	24-27-30-32 mm	1	009201744
-----------------	----------------	---	-----------

920FTX

hand sockets for Torx® head screws

12"



Ø	L	Ø1	1	2
E10	13,2	36	21	5 009200380
E12	15,0	37	21	5 009200381
E14	16,3	37	21	5 009200382
E16	18,8	37	22	5 009200383
E18	20,4	37	22	5 009200384
E20	22,9	37	22	5 009200385
E22	25,0	37	24	3 009200387
E24	26,5	40	25	3 009200388

12"



920FTX/SB6	E10-E12-E14	1	009200390
	E16-E18-E20		

12"



920FTX/C8	E10-E12-E14-E16	1	009200391
	E18-E20-E22-E24		
	270X120X45 mm		1 kg

920FTX/L

hand sockets for Torx® head screws, long series

12"



	Ø	L	Ø1	1	2
E10	13,2	77	21,0	5	009200400
E12	15,0	77	21,0	5	009200401
E14	16,3	77	21,0	5	009200402
E16	18,8	77	21,8	3	009200403
E18	20,4	77	21,8	3	009200404
E20	22,9	77	22,0	3	009200405

12"



920FTX-LSB6	E10-E12-E14	1	009200409
	E16-E18-E20		

920LP

socket drivers for slotted head screws

12"



SxA	Ø	L	L1	1	2
1x5,5	22,5	62	24	3	009200452
1,2x6,5	22,5	62	24	3	009200453
1,2x8	22,5	62	24	3	009200454
1,6x9	22,5	62	24	3	009200456
2x12	22,5	62	24	3	009200458

920PH

socket drivers for cross head Phillips® screws

12"



PH	Ø	L	L1	1	2
1	22,5	56	18	3	009200471
2	22,5	56	18	3	009200472
3	22,5	56	18	3	009200473
4	22,5	56	18	3	009200474

12"



920PH/SB4	PH1-PH2-PH3-PH4	1	009200479
------------------	-----------------	---	-----------

920LH/SB7

socket drivers for cross head Phillips® screws

12"



920LH/SB7		1	009200478
920LP	1,2x6,5 - 1,2x8		
920PH	1,6x9 - 2x12 mm		
	PH2 - PH3 - PH4		

920PE

socket drivers for hexagon screws

12"



DIN 7422

mm	Ø	L	L1	1	2
3	22,5	58	20	5	009200410
4	22,5	58	20	5	009200412
5	22,5	58	20	5	009200414
5L	22,5	100	62	5	009200415
6	22,5	58	20	5	009200417
6L	22,5	100	62	5	009200418
7	22,5	58	20	5	009200420
7L	22,5	100	62	5	009200421
8	22,5	58	20	5	009200423
8L	22,5	100	62	5	009200424
9	22,5	58	20	5	009200425
9L	22,5	140	102	5	009200426
10	22,5	58	20	5	009200428
10L	22,5	140	102	5	009200429
12	23,0	58	20	5	009200432
12L	22,5	140	102	5	009200433
14	23,0	58	20	5	009200434
14L	22,5	140	102	5	009200435
17	29,5	60	22	5	009200437
19	29,5	60	22	5	009200439

12"



920PE/SB9	4-5-6-8-10 mm	1	009200441
	5L-6L-8L-10L mm		

12"



920PE/C10
4-5-6-7-8-10
12-14-17-19 mm

1 009200443

270X120X45 mm - 1,5 kg

920PE/AS

socket drivers for hexagon screws

12"



"	Ø mm	L mm	L1 mm		
1/8	22,5	58	20	2	009200460
3/16	22,5	58	20	2	009200461
1/4	22,5	58	20	2	009200463
3/8	22,5	58	20	2	009200464
1/2	22,5	60	20	2	009200465
3/4	22,5	60	20	1	009200468

12"



920PE-AS/SB6
1/8-3/16-1/4-3/8-1/2-3/4

1 009200469

920BP

ball head socket drivers for hexagon screws

12"

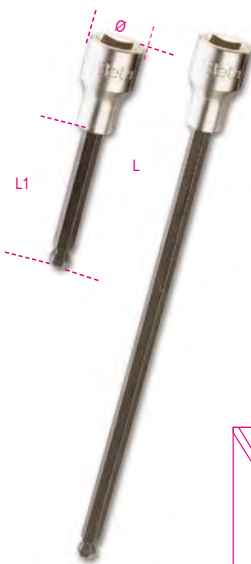

mm	Ø mm	L mm	L1 mm		
5L	22,5	100	62	5	009200490
5XL	22,5	240	202	1	009200495
6L	22,5	100	62	5	009200491
6XL	22,5	240	202	1	009200496
7L	22,5	100	62	5	009200492
8L	22,5	100	62	5	009200493
8XL	22,5	240	202	1	009200497
10L	22,5	140	102	5	009200494

12"



920BP/SB8
5L-6L-7L-8L-10L mm
5XL-6XL-8XL mm

1 009200500

920ME

socket drivers for hexagon screws

12"



mm	Ø mm	L mm	L1 mm		
5	21	75	15,5	5	009200505
6	21	75	15,5	5	009200506
7	21	75	15,5	5	009200507
8	21	75	15,5	5	009200508
10	23	75	15,5	5	009200510
12	24	75	15,5	5	009200512
14	24	75	15,5	5	009200514
17	24	75	15,5	5	009200517

12"



920ME/SB7
5-6-8-10-12-14-17 mm

1 009200519

12"



920ME/C7
5-6-8-10-12-14-17 mm

1 009200518

920TX

socket drivers for Torx® head screws

12"



mm	Ø mm	L mm	L1 mm		
T20	22,5	58	20	5	009200520
T20L	22,5	120	82	3	009200530
T25	22,5	58	20	5	009200521
T25L	22,5	120	82	3	009200531
T27	22,5	58	20	5	009200522
T27L	22,5	120	82	3	009200533
T30	22,5	58	20	5	009200523

	Ø mm	L mm	L1 mm		
T30L	22,5	120	82	3	009200534
T40	22,5	58	20	5	009200524
T40L	22,5	120	82	3	009200535
T45	22,5	58	20	5	009200525
T45L	22,5	120	82	3	009200537
T50	22,5	58	20	5	009200526
T50L	23,0	140	102	3	009200538
T55	23,0	58	20	3	009200527
T55L	23,0	140	102	3	009200539
T60	23,0	58	20	3	009200528
T60L	23,0	140	102	3	009200540
T70L	23,0	120	82	3	009200541

12"



920TX-SB9
T20-T25-T27-T30
T40-T45-T50-T55-T60

1 009200532

12"



920TX-L/SB10
T20L-T25L-T27L-T30L-T40L-
T45L-T50L-T55L-T60L-T70L

1 009200545

12"



920TX/C9
T20-T25-T27-T30-T40
T45-T50-T55-T60

1 009200546

270X120X45 mm - 1,2 kg

920RTX

socket drivers for Tamper Resistant Torx® head screws

12"



	Ø mm	L mm	L1 mm		
T20	22,5	58	20	5	009200370
T25	22,5	58	20	5	009200371
T27	22,5	58	20	5	009200372
T30	22,5	58	20	5	009200373
T40	22,5	58	20	5	009200374

12"



920RTX/SB5
T20-T25-T27-T30-T40

1 009200378

920XZN

socket drivers with XZN® profile

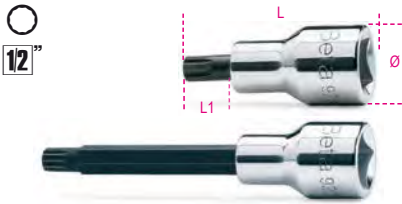

DIN 2324

Ø	Ø mm	L mm	L1 mm	QTY	Part No.
M4	22,5	58	20	3	009200559
M5	22,5	58	20	3	009200560
M6	22,5	58	20	3	009200561
M6L	22,5	100	62	3	009200562
M8	22,5	58	20	3	009200563
M8L	22,5	100	62	3	009200564
M9	22,5	58	20	3	009200582
M9L	22,5	100	62	3	009200583
M10	22,5	58	20	3	009200565
M10L	22,5	100	62	3	009200566
M12	22,5	58	20	3	009200568
M12L	22,5	100	62	3	009200569
M14	23,0	58	20	3	009200571
M14L	23,0	100	62	3	009200572
M16	23,0	58	20	3	009200573
M18	23,0	58	20	3	009200574



920XZN/SB7
M4-M5-M6-M8
M10-M12-M14



920XZN/SB12
M5-M6-M8-M10-M12
M14-M16-M6L-M8L
M10L-M12L-M14L



920XZN-L/S5
M6L-M8L-M10L
M12L-M14L

920ES

special form socket drivers



UNI 9326

Ø	Ø mm	L mm	L1 mm	QTY	Part No.
7	(6R)	58	20	5	009200587
7XL	(6R)	240	202	1	009200607
9	(8R)	58	20	5	009200589
9XL	(8R)	240	202	1	009200609
10	(8S)	58	20	5	009200590
10XL	(8S)	240	202	1	009200610
11	(10R)	58	20	5	009200591
11XL	(10R)	240	202	1	009200611
12L	(10S)	240	202	3	009200592
12XL	(10S)	240	202	1	009200612
14L	(12S)	100	62	3	009200594
14XL	(12S)	240	202	1	009200614
16L	(14R)	100	62	3	009200596
16XL	(14R)	240	202	1	009200616



920ES/SB7
7-9-10-11-12L-14L-16L



920ES-XL/SB7
7XL-9XL-10XL-11XL
12XL-14XL-16XL

920/15

adaptor, 1/2" female and 3/8" male drives



UNI/ISO 3316 DIN 3123

L	□	■	Ø	QTY	Part No.
42	1/2	3/8	22,0	5	009200810



Always apply torque loads evenly and progressively to avoid breakage and any possible injury.

920/16

adaptor, 1/2" female and 3/4" male drives



UNI/ISO 3316 DIN 3123

L	□	■	Ø	QTY	Part No.
46	1/2	3/4	26	5	009200814

920/20÷920/23

1/2" drive extension bars

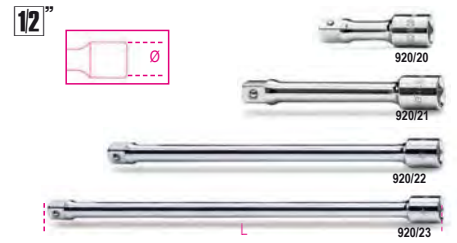

UNI/ISO 3316 DIN 3123

	L mm	Ø mm	QTY	Part No.
920/20	75	22	5	009200818
920/21	125	22	5	009200822
920/22	255	22	5	009200826
920/23	375	22	2	009200827

920AN

1/2" wobble extension bars

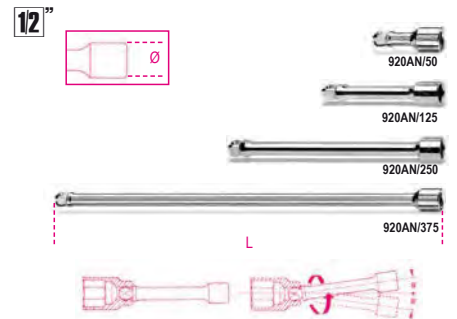

	L mm	Ø mm	QTY	Part No.
920AN/50	50	22	5	009200833
920AN/125	125	22	5	009200834
920AN/250	250	22	3	009200835
920AN/375	375	22	3	009200836

920/25

1/2" drive universal joint



UNI/ISO 3316 DIN 3123

L	Ø	QTY	Part No.
75	27	5	009200830

920/35A

1/2" drive swivel handle



UNI/ISO 3315 DIN 3122

L	L1	QTY	Part No.
285	160	3	009200846



920M/35

1/2" swivel drive with metal handle



UNI/ISO 3315 DIN 3122

L	mm	2	009200845
380			

920M/35L

1/2" swivel drive with metal handle, long series



L	mm	1	009200843
600			

 Always apply torque loads evenly and progressively to avoid breakage and any possible injury.

920/36A

1/2" drive swivel handle



UNI/ISO 3315 DIN 3122

L	L1	mm	mm	2	009200847
408	283				

920/38

1/2" extension drive swivel handle



L	L max	mm	mm	1	009200839
262	402				

920/40

1/2" drive swivel T-handle



L	L1	mm	mm	2	009200850
490	230				

920/42

1/2" drive sliding T handle

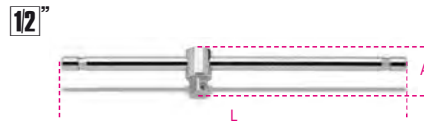

UNI/ISO 3315 DIN 3122

L	A	mm	mm	5	009200854
305	42				

920/44

1/2" drive offset handle



UNI/ISO 3315 DIN 3122

L	L1	mm	mm	3	009200858
230	60				

920/46

1/2" drive with speed brace

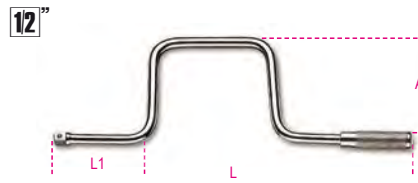

UNI/ISO 3315 DIN 3122

L	L1	A	mm	mm	mm	1	009200862
385	110	160					

920/50

1/2" push-through drive ratchet, 72 teeth



UNI/ISO 3315 DIN 3122

L	Ø	A	mm	mm	mm	3	009200871
275	40	42					

920/50F

1/2" female square drive ratchet, 72 teeth



UNI/ISO 3315 DIN 3122

L	Ø	A	mm	mm	mm	2	009200889
275	40	27					

920/55

1/2" drive reversible ratchet, 72 teeth



UNI/ISO 3315 DIN 3122

L	Ø	A	mm	mm	mm	3	009200882
275	40	43					

920/55Q

1/2" drive reversible ratchet, 48 teeth



UNI/ISO 3315 DIN 3122

L	Ø	A	mm	mm	mm	3	009200885
275	40	43					

920/55X

1/2" drive reversible ratchet, 72 teeth



UNI/ISO 3315 DIN 3122

L	Ø	A	mm	mm	mm	3	009200895
200	30	33					

920/55LC

1/2" drive reversible ratchet "Locking System", 72 teeth



UNI/ISO 3315 DIN 3122

L	Ø	A	mm	mm	mm	2	009200896
275	40	43					

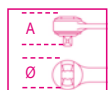

920/55L

extension reversible ratchet,
1/2" male drive,
72 tooth mechanism



L	L max	Ø	A	
mm	mm	mm	mm	
282	422	40	43	1 009200927

920M/55

1/2" drive reversible ratchet
with metal handle

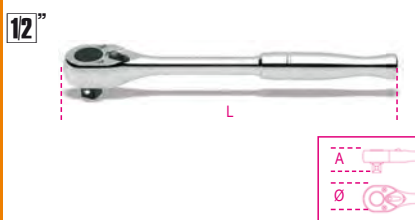

L	Ø	A	
mm	mm	mm	
253	38	35	1 009200893

920/56A

1/2" drive swivel reversible ratchet,
72 teeth



L	Ø	A	
mm	mm	mm	
315	40	43	1 009200911

920M/56

1/2" drive reversible swivel ratchet
with metal handle



L	Ø	A	
mm	mm	mm	
330	38	35,7	2 009200894



920/58

1/2" drive reversible ratchet
with rotating handle,
52 tooth mechanism

- Socket release button
- Ring nut reversal system on ratchet head
- Bi-material handle



L	Ø	A	
mm	mm	mm	
281	42,5	45	1 009200926

Spare parts
rotating mechanism of ratchets,
see table after item 929/C8

920.../C11

11 sockets and 2 accessories



920A/C11 1 009200921

Ø 920A	
10 - 12 - 13 - 14 - 15 - 16	
17 - 18 - 19 - 21 - 22 mm	
920/22	255 mm
920/50	

335x145x60 mm - 2,5 kg

920B/C11 1 009200922

Ø 920B	
10 - 12 - 13 - 14 - 15 - 16	
17 - 18 - 19 - 21 - 22 mm	
920/22	255 mm
920/50	

335x145x60 mm - 2,5 kg

920.../C12...

12 sockets and 5 accessories



920A/C12X 1 009200933

Ø 920A	
10 - 11 - 12 - 13 - 14 - 17 - 19	
22 - 24 - 27 - 30 - 32 mm	
920/21	125 mm
920/22	255 mm
920/25	
920/42	
920/55	

420x185x60 mm - 4,2 kg

920A/C12 1 009200931

Ø 920A	
10 - 11 - 12 - 13 - 14 - 17 - 19	
22 - 24 - 27 - 30 - 32 mm	
920/21	125 mm
920/22	255 mm
920/25	
920/42	
920/50	

420x185x60 mm - 4,2 kg

920B/C12X 1 009200934

Ø 920B	
10 - 11 - 12 - 13 - 14 - 17 - 19	
22 - 24 - 27 - 30 - 32 mm	
920/21	125 mm
920/22	255 mm
920/25	
920/42	
920/55	

420x185x60 mm - 4,0 kg

920B/C12 1 009200932

Ø 920B	
10 - 11 - 12 - 13 - 14 - 17 - 19	
22 - 24 - 27 - 30 - 32 mm	
920/21	125 mm
920/22	255 mm
920/25	
920/42	
920/50	

420x185x60 mm - 4,0 kg

920MC/C14







14 coloured hexagon hand sockets and 5 accessories

12"



920MC/C14

1 009202964

 920MC	8 - 10 - 11 - 12 - 13 - 14 - 15 - 16 - 17 - 18 - 19 - 21 - 22 - 24 mm
 920/21	125 mm
 920/22	255 mm
 920/25	
 920/42	
 920/55	
≡ 420x185x60 mm - 4,2 kg	

920.../C20...







20 sockets and 5 accessories

12"







920A/C20X

1 009200950

 920A	10 - 11 - 12 - 13 - 14 - 15 - 16 - 17 - 18 - 19 - 20 - 21 - 22 - 23 - 24 - 26 - 27 - 28 - 30 - 32 mm
 920/21	125 mm
 920/22	255 mm
 920/25	
 920/42	
 920/55	
≡ 420x185x60 mm - 5,1 kg	





920A/C20

1 009200948

 920A	10 - 11 - 12 - 13 - 14 - 15 - 16 - 17 - 18 - 19 - 20 - 21 - 22 - 23 - 24 - 26 - 27 - 28 - 30 - 32 mm
 920/21	125 mm
 920/22	255 mm
 920/25	
 920/42	
 920/50	
≡ 420x185x60 mm - 5,1 kg	



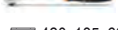

920A/C20Q

1 009200955

 920A	10 - 11 - 12 - 13 - 14 - 15 - 16 - 17 - 18 - 19 - 20 - 21 - 22 - 23 - 24 - 26 - 27 - 28 - 30 - 32 mm
 920/21	125 mm
 920/22	255 mm
 920/25	
 920/42	
 920/55Q	
≡ 420x185x60 mm - 5,1 kg	





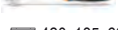

920B/C20

1 009200949

 920B	10 - 11 - 12 - 13 - 14 - 15 - 16 - 17 - 18 - 19 - 20 - 21 - 22 - 23 - 24 - 26 - 27 - 28 - 30 - 32 mm
 920/21	125 mm
 920/22	255 mm
 920/25	
 920/42	
 920/50	
≡ 420x185x60 mm - 5,0 kg	

920B/C20X

1 009200951

 920B	10 - 11 - 12 - 13 - 14 - 15 - 16 - 17 - 18 - 19 - 20 - 21 - 22 - 23 - 24 - 26 - 27 - 28 - 30 - 32 mm
 920/21	125 mm
 920/22	255 mm
 920/25	
 920/42	
 920/55	
≡ 420x185x60 mm - 5,0 kg	

920.../C21...







21 sockets and 6 accessories

12"







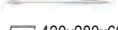

920A/C21

1 009200952

 920A	10 - 11 - 12 - 13 - 14 - 15 - 16 - 17 - 18 - 19 - 20 - 21 - 22 - 23 - 24 - 25 - 26 - 27 - 28 - 30 - 32 mm
 920/21	125 mm
 920/22	255 mm
 920/25	
 920/42	
 920/46	
 920/50	
≡ 420x280x60 mm - 6,5 kg	





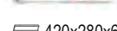

920A/C21X

1 009200983

 920A	10 - 11 - 12 - 13 - 14 - 15 - 16 - 17 - 18 - 19 - 20 - 21 - 22 - 23 - 24 - 25 - 26 - 27 - 28 - 30 - 32 mm
 920/21	125 mm
 920/22	255 mm
 920/25	
 920/42	
 920/46	
 920/55	
≡ 420x280x60 mm - 6,4 kg	





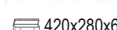

920B/C21

1 009200953

 920B	10 - 11 - 12 - 13 - 14 - 15 - 16 - 17 - 18 - 19 - 20 - 21 - 22 - 23 - 24 - 25 - 26 - 27 - 28 - 30 - 32 mm
 920/21	125 mm
 920/22	255 mm
 920/25	
 920/42	
 920/46	
 920/50	
≡ 420x280x60 mm - 6,4 kg	

920B/C21X

1 009200984

 920B	10 - 11 - 12 - 13 - 14 - 15 - 16 - 17 - 18 - 19 - 20 - 21 - 22 - 23 - 24 - 25 - 26 - 27 - 28 - 30 - 32 mm
 920/21	125 mm
 920/22	255 mm
 920/25	
 920/42	
 920/46	
 920/55	
≡ 420x280x60 mm - 6,4 kg	



920B/C300

30 bi-hex sockets and 5 accessories

12"



920B/C30Q

1 009200975

	○ 920B	8 - 9 - 10 - 11 - 12 - 13 - 14 15 - 16 - 17 - 18 - 19 - 20 - 21 22 - 23 - 24 - 26 - 27 - 30 mm
	○ 920BL	12 - 13 - 14 - 17 - 19 - 21 22 - 24 - 27 - 30 mm
	920/21	125 mm
	920/22	255 mm
	920/25	
	920/42	
	920/55Q	
≡ 420x280x60 mm - 7,6 kg		

920.../C33

20 sockets, 13 socket drivers
and 5 accessories

12"



920A/C33

1 009200985

	○ 920A	10 - 11 - 12 - 13 - 14 - 15 - 16 17 - 18 - 19 - 20 - 21 - 22 - 23 24 - 26 - 27 - 28 - 30 - 32 mm
	● 920LP	1,2x8 - 1,6x9 - 2x12 mm
	⊕ 920PH	PH2 - PH3 - PH4
	○ 920PE	4 - 5 - 6 - 8 - 10 - 12 - 14 mm
	920/21	125 mm
	920/22	255 mm
	920/25	
	920/42	
	920/55	
≡ 420x280x60 mm - 6,7 kg		

920B/C33

1 009200986

	○ 920B	10 - 11 - 12 - 13 - 14 - 15 - 16 17 - 18 - 19 - 20 - 21 - 22 - 23 24 - 26 - 27 - 28 - 30 - 32 mm
	● 920LP	1,2x8 - 1,6x9 - 2x12 mm
	⊕ 920PH	PH2 - PH3 - PH4
	○ 920PE	4 - 5 - 6 - 8 - 10 - 12 - 14 mm
	920/21	125 mm
	920/22	255 mm
	920/25	
	920/42	
	920/55	
≡ 420x280x60 mm - 6,7 kg		

920/C37

37 bi-hex sockets and 5 accessories

12"



920/C37

1 009200988

	○ 920B	10 - 11 - 12 - 13 - 14 - 15 - 16 17 - 18 - 19 - 20 - 21 - 22 - 23 24 - 26 - 27 - 28 - 30 - 32 mm
	○ 920AS	3/8 - 7/16 - 1/2 - 9/16 - 19/32 5/8 - 11/16 - 3/4 - 25/32 - 13/16 7/8 - 15/16 - 1 - 1.1/16 - 1.1/8 1.3/16 - 1.1/4
	920/21	125 mm
	920/22	255 mm
	920/25	
	920/42	
	920/55	
≡ 420x280x60 mm - 7,5 kg		

920AS/C10

10 bi-hex sockets and 2 accessories

12"



920AS/C10

1 009200919

	○ 920AS	3/8 - 7/16 - 1/2 - 9/16 - 5/8 11/16 - 3/4 - 13/16 - 7/8 - 15/16
	920/22	255 mm
	920/50	
≡ 335x145x60 mm - 2,6 kg		

920AS/C15

15 bi-hex sockets and 6 accessories

12"



920AS/C15

1 009200947

	○ 920AS	3/8 - 7/16 - 1/2 - 9/16 - 5/8 - 11/16 3/4 - 13/16 - 7/8 - 15/16 - 1 1.1/16 - 1.1/8 - 1.3/16 - 1.1/4
	920/21	125 mm
	920/22	255 mm
	920/25	
	920/42	
	920/46	
	920/50	
≡ 420x280x60 mm - 5,9 kg		

Beta

920AS/C17X

17 bi-hex sockets and 5 accessories

12"



920AS/C17X

1 009200942

	920AS	3/8 - 7/16 - 1/2 - 9/16 - 19/32 - 5/8 11/16 - 3/4 - 25/32 - 13/16 - 7/8 15/16 - 1 - 1.1/16 - 1.1/8 - 1.3/16 - 1.1/4
	920/21	125 mm
	920/22	255 mm
	920/25	
	920/42	
	920/55	

420x185x60 mm - 4,8 kg

920AS/MBM-C21

16 bi-hex sockets and 5 accessories for aeronautical maintenance

12"



920AS/MBM-C21

1 009200944

	920AS	3/8 - 7/16 - 1/2 - 9/16 19/32 - 5/8 - 11/16 - 3/4 25/32 - 13/16 - 7/8 - 15/16 1 - 1.1/16 - 1.3/16 - 1.1/4
	920M/55	
	920/21	125 mm
	920/22	255 mm
	920/25	
	920/42	

420x185x60 mm - 5,0 kg

920TX/C17

6 bits, 6 sockets, 5 socket drivers and 4 accessories for Torx® head screws



12"



920TX/C17

1 009200989

	861TX	T8 - T10 - T15 - T20 - T25 - T27
	897	
	920TX	T27 - T30 - T40 - T45 - T50
	920FTX	E10 - E12 - E14 - E16 - E18 - E20
	920/20	75 mm
	920/22	255 mm
	920/55	

420x185x60 mm - 2,9 kg

920A/C17HR

17 hexagon sockets and 5 accessories in hard foam tray, in metal case

• ratchet with rotating handle

12"



920A/C17HR

1 009200939

	920A	10-11-12-13-14-15-16-17-18-19-20- 21-22-24-27-30-32 mm
	920/21	125 mm
	920/22	255 mm
	920/25	
	920/42	
	920/58	

420x185x60 mm - 5,1 kg

928A

hexagon hand sockets



UNI/ISO 2725
DIN 3124

Ø mm	Ø mm	L mm	Ø1 mm	Hand	Part No.
19	29,2	50	34	5	009280019
21	30,0	51	34	5	009280021
22	31,3	53	34	5	009280022
23	33,3	53	34	5	009280023
24	34,5	53	34	5	009280024
26	36,8	55	35	5	009280026
27	38,0	56	35	5	009280027
28	39,0	57	35	3	009280028
29	40,2	58	35	3	009280029
30	41,5	58	37	3	009280030
32	44,3	60	37	3	009280032
33	45,8	60	37	3	009280033
34	46,8	60	37	3	009280034
35	48,1	62	38	3	009280035
36	49,5	64	38	3	009280036
38	52,0	68	40	3	009280038
41	56,0	71	40	3	009280041
46	62,3	75	43	3	009280046
50	67,4	80	43	3	009280050
55	73,7	84	48	1	009280055
60	80,0	87	48	1	009280060

928B

bi-hex hand sockets



UNI/ISO 2725
DIN 3124

Ø mm	Ø mm	L mm	Ø1 mm	Hand	Part No.
19	29,2	50	34	5	009280119
21	30,0	51	34	5	009280121
22	31,3	53	34	5	009280122
23	33,3	53	34	5	009280123
24	34,5	53	34	5	009280124
26	36,8	55	35	5	009280126
27	38,0	56	35	5	009280127
28	39,0	57	35	3	009280128
29	40,2	58	35	3	009280129
30	41,5	58	37	3	009280130
32	44,3	60	37	3	009280132
33	45,8	60	37	3	009280133
34	46,8	60	37	3	009280134
35	48,1	62	38	3	009280135
36	49,5	64	38	3	009280136
38	52,0	68	40	3	009280138
41	56,0	71	40	3	009280141
46	62,3	75	43	3	009280146
50	67,4	80	43	3	009280150
55	73,7	84	48	1	009280155
60	80,0	87	48	1	009280160

928AS

hexagon hand sockets



Hexagon Size	Ø mm	L mm	Ø1 mm	QTY	Part No.
7/8	32,0	53	34	1	009280202
15/16	34,5	53	34	1	009280203
1	36,2	55	35	1	009280204
1.1/16	38,0	56	35	1	009280205
1.1/8	40,2	58	35	1	009280206
1.1/4	44,2	60	37	1	009280208
1.5/16	45,8	60	37	1	009280209
1.3/8	48,1	62	38	1	009280210
1.7/16	49,5	64	38	1	009280211
1.1/2	52,0	68	40	1	009280212
1.5/8	56,0	71	40	1	009280214
1.11/16	58,8	74	40	1	009280215
1.13/16	62,3	75	43	1	009280217
1.7/8	65,0	78	43	1	009280218
2	68,3	80	43	1	009280219
2.1/16	71,5	83	48	1	009280220

928ME

socket drivers for hexagon screws



Hexagon Size	Ø mm	L mm	L1 mm	QTY	Part No.
14	35	75	15,5	2	009280514
17	35	75	15,5	2	009280517
19	35	75	15,5	2	009280519
22	35	75	22,5	2	009280522

928/15

adaptor, 3/4" female and 1/2" male drives



UNI/ISO 3316
DIN 3123

L mm	Ø mm	Female Drive	Male Drive	QTY	Part No.
51,5	34	3/4	1/2	5	009280801



Always apply torque loads evenly and progressively to avoid breakage and any possible injury.

928/16

adaptor, 3/4" female and 1" male drives



UNI/ISO 3316
DIN 3123

L mm	Ø mm	Female Drive	Male Drive	QTY	Part No.
65	34	3/4	1"	5	009280807

928/20 - 928/21 - 928/22

3/4" drive extension bars

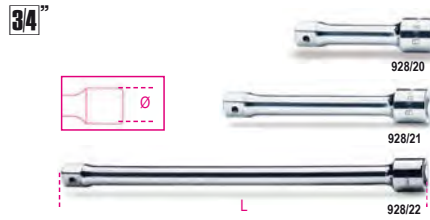

UNI/ISO 3316
DIN 3123

Part No.	L mm	Ø mm	QTY	Part No.
928/20	100	34	3	009280810
928/21	200	34	3	009280815
928/22	380	34	3	009280825

928/25

3/4" drive universal joint



UNI/ISO 3316 DIN 3123

L mm	Ø mm	QTY	Part No.
108	40	1	009280830

928/36A

3/4" drive swivel handle



DIN 3122 - UNI ISO 3315

L mm	QTY	Part No.
545	1	009280844

928/42

3/4" drive slide T-handle

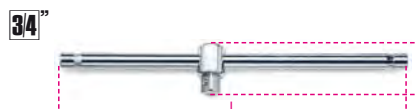

UNI/ISO 3315 DIN 3122

L mm	A mm	QTY	Part No.
450	62,5	3	009280850

928/55

3/4" drive reversible ratchet, 72 teeth



DIN 3122 - UNI ISO 3315

L mm	Ø mm	A mm	QTY	Part No.
510	58	59	2	009280862

Spare parts rotating mechanism of ratchets, see table after item 929/C8

928.../C12

assortment of 12 hexagon hand sockets and 5 accessories in sheet metal case



Part No.	QTY	Part No.
928A/C12	1	009280955

Part No.	Length (mm)
928A	22 - 24 - 27 - 30 - 32 - 34 - 36 38 - 41 - 46 - 50 - 55 mm
928/21	200 mm
928/22	380 mm
928/25	
928/42	
928/55	

530x220x80 mm - 13,5 kg

Part No.	QTY	Part No.
928B/C12	1	009280957

Part No.	Length (mm)
928B	22 - 24 - 27 - 30 - 32 - 34 - 36 38 - 41 - 46 - 50 - 55 mm
928/21	200 mm
928/22	380 mm
928/25	
928/42	
928/55	

530x220x80 mm - 13,5 kg

Beta
Quality Tools

928AS/C12

assortment of 12 hexagon hand sockets and 5 accessories in sheet metal case



928AS/C12

1 009280968

- 928AS 7/8-15/16-1.1/16-1.1/8-1.1/4
1.5/16-1.7/16-1.1/2-1.11/16
1.13/16-1.7/8-2.1/16
- 928/21 200 mm
- 928/22 380 mm
- 928/25
- 928/42
- 928/55

530x220x80 mm - 13,5 kg

929

hexagon hand sockets



UNI/ISO 2725 DIN 3124

Ø mm	Ø mm	L mm	Ø1 mm	
36	51	65	48	1 009290036
41	57	70	48	1 009290041
46	65	75	48	1 009290046
50	70	80	48	1 009290050
55	76	85	54	1 009290055
60	82	90	54	1 009290060
65	88	95	54	1 009290065
70	92	100	60	1 009290070
75	99	110	60	1 009290075
80	106	120	60	1 009290080

929/15

adaptor, 1" female and 3/4" male drives



UNI/ISO 3316 DIN 3123

L mm	Ø mm	□	■	
65	47	1"	3/4"	2 009290801

Always apply torque loads evenly and progressively to avoid breakage and any possible injury.

929/21 - 929/22

1" drive extension bars



UNI/ISO 3316 DIN 3123

	L mm	Ø mm	
929/21	200	47	1 009290815
929/22	400	47	1 009290825

929/42

1" drive slide T-handle



UNI/ISO 3315 DIN 3122

L mm	
535	1 009290850

929/55

1" reversible ratchet 72 teeth



UNI/ISO 3315 DIN 3122

L mm	Ø mm	A mm	
770	62	63	1 009290860

929/C8

8 hexagon sockets and 5 accessories



929/C8

1 009290925

- 929 46 - 50 - 55 - 60 - 65
70 - 75 - 80 mm
- 929/15 □ 1" - ■ 3/4"
- 929/21 200 mm
- 929/22 400 mm
- 929/42
- 929/55

560x290x12 mm - 29 kg

900/R55



900/R55
666N/2-900/55

1 009000871

900/R55-Z



900/R55-Z
900/55-Z

1 009000872

900M/R55



900M/R55
900M/55

1 009000888

910/R55



910/R55
599DGT/6-606/6-606/10-612
665/5-665/10-665LB/6-665LB/10
666N/5-666N/10-666N LBF.IN/5-666N
LBF.IN
666/6-666/10-910/55

1 009100879

910M/R55



910M/R55
910M/55-910M/56

1 009100888

910/R55Q



910/R55Q
910/55Q

1 009100877

910/R55X



1 009100897

910/R55X
666N/2X

920/R50



1 009200866

920/R50
614/50-667/20-667/30
920/50

920/R55



1 009200879

920/R55
606/20-606/30-666/20-666/30
920/55-920/56A- 599DGT/20-
599DGT/30-599DGT-AN/20
665/20-665/30-665LB/20-665LB/30
666N/20-666N/30-666N LBF.IN/20-666N
LBF.IN/30

920M/R55



1 009200888

920M/R55
920M/55-920M/56

920/R55Q



1 009200877

920/R55Q
920/55Q

920/R55X



1 009200878

920/R55X
606/10X-612X
666/10X-920/55X-599DGT/10X-599DGT-
AN/10
665/10X-665LB/10X-666N10X-666N
LBF.IN/10X

920/R55LC



1 009200887

920/R55LC
920/55LC "Locking System"

928/R55



1 009280859

928/R55
928/55

928/R55X



1 009280858

928/R55X
614X

929/R55



1 009290859

929/R55
929/55



930

double ended bi-hex tubular socket wrenches,
heavy series



UNI 6745

mm	L mm	Ø mm	Ø1 mm	
6x7	100	9,5	11,0	3 009300006
8x9	108	12,5	14,0	3 009300010
10x11	116	15,0	16,5	3 009300014
12x13	124	17,5	19,0	3 009300018
14x15	132	20,0	21,5	3 009300023
16x17	140	23,0	24,0	3 009300027
18x19	148	25,0	26,5	3 009300032
20x22	156	28,0	30,0	2 009300036
21x23	163	29,0	31,5	2 009300040
24x26	173	33,0	35,5	2 009300044
25x28	182	34,5	38,0	2 009300048
27x29	191	37,0	39,5	2 009300052
30x32	200	40,5	43,0	2 009300056



1 009300081

930/S8
6x7-8x9-10x11
12x13-14x15-16x17
18x19-20x22 mm

940/1 - /2

930/S13
6x7-8x9-10x11-12x13
14x15-16x17-18x19
20x22-21x23-24x26
25x28-27x29-30x32 mm

940/1 - /2 - /3



1 009300098

930/C13
6x7-8x9-10x11-12x13
14x15-16x17-18x19
20x22-21x23-24x26
25x28-27x29-30x32 mm

940/1 - /2 - /3

932

double ended hexagon / bi-hex offset
socket wrenches, bright chrome-plated

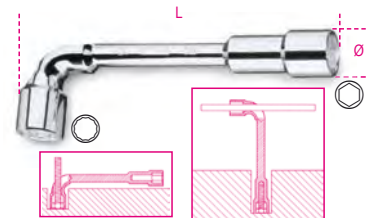

NF E 74.303

mm	Ø mm	L mm	
6x6	11,5	110	5 009320006
7x7	12,5	116	5 009320007
8x8	13,0	120	5 009320008
9x9	14,0	125	5 009320009
10x10	16,5	133	5 009320010
11x11	17,5	143	5 009320011
12x12	19,0	148	5 009320012
13x13	19,5	154	5 009320013
14x14	21,5	167	5 009320014
15x15	22,5	182	5 009320015
16x16	24,5	193	5 009320016
17x17	26,0	198	5 009320017
18x18	26,5	215	5 009320018
19x19	29,0	220	5 009320019
20x20	30,5	222	3 009320020
21x21	30,5	236	3 009320021
22x22	32,5	250	2 009320022
23x23	33,5	256	2 009320023
24x24	35,0	272	2 009320024
25x25	36,5	282	2 009320025
26x26	37,5	296	2 009320026
27x27	39,0	296	2 009320027
28x28	39,0	314	2 009320028
30x30	42,5	348	2 009320030
32x32	45,5	364	2 009320032



932/S11	1	009320080
6-7-8-10-11-12		
13-14-17-19-22 mm		
932/S17	1	009320081
6-7-8-9-10-11-12		
13-14-15-16-17		
18-19-20-21-22 mm		
932/S25	1	009320082
6-7-8-9-10-11-12-13		
14-15-16-17-18-19		
20-21-22-23-24-25		
26-27-28-30-32 mm		

933

double ended offset hexagon socket wrenches, bright chrome-plated

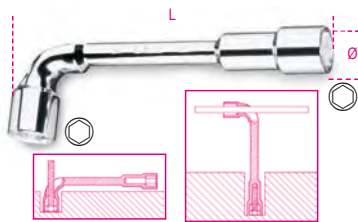

NF E 74.303

mm	Ø	L		
mm	mm	mm		
6x6	11,5	110	5	009330006
7x7	12,5	116	5	009330007
8x8	13,0	120	5	009330008
9x9	14,0	125	5	009330009
10x10	16,5	133	5	009330010
11x11	17,5	143	5	009330011
12x12	19,0	148	5	009330012
13x13	19,5	154	5	009330013
14x14	21,5	167	5	009330014
15x15	22,5	182	5	009330015
16x16	24,5	193	5	009330016
17x17	26,0	198	5	009330017
18x18	26,5	215	5	009330018
19x19	29,0	220	5	009330019
20x20	30,5	222	3	009330020
21x21	30,5	236	3	009330021
22x22	32,5	250	2	009330022
23x23	33,5	256	2	009330023
24x24	35,0	272	2	009330024
25x25	36,5	282	2	009330025
26x26	37,5	296	2	009330026
27x27	39,0	296	2	009330027
28x28	39,0	314	2	009330028
30x30	42,5	348	2	009330030
32x32	45,5	364	2	009330032



933/S11	1	009330080
6-7-8-10-11-12		
13-14-17-19-22 mm		
933/S17	1	009330081
6-7-8-9-10-11-12		
13-14-15-16-17		
18-19-20-21-22 mm		
933/S25	1	009330082
6-7-8-9-10-11-12-13		
14-15-16-17-18-19		
20-21-22-23-24-25		
26-27-28-30-32 mm		

935

double ended hexagon tubular socket wrenches, light series



UNI 6746 DIN 896

mm	L		
mm	mm		
6x7	100	5	009350105
8x9	110	5	009350111
10x11	120	5	009350115
12x13	130	5	009350117
14x15	140	5	009350126
16x17	150	5	009350128
18x19	160	5	009350131
20x22	170	3	009350138
21x23	180	3	009350141
24x26	190	3	009350144
25x28	200	2	009350150
27x29	210	2	009350153
30x32	220	2	009350156



935/S8	1	009350181
6x7-8x9-10x11		
12x13-14x15-16x17		
18x19-20x22 mm		
940/1 - /2		
935/S13	1	009350183
6x7-8x9-10x11		
12x13-14x15-16x17		
18x19-20x22-21x23		
24x26-25x28-27x29		
30x32 mm		
940/1 - /2 - /3		

937

double ended hexagon / bi-hex socket wrenches, chrome-plated

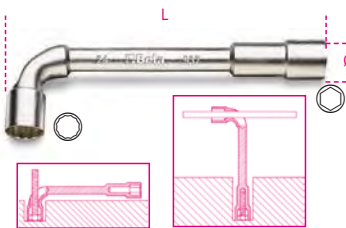

mm	Ø	L		
mm	mm	mm		
6x6	11,5	110	5	009370006
7x7	12,5	116	5	009370007
8x8	13,0	120	5	009370008
9x9	14,0	125	5	009370009
10x10	16,5	133	5	009370010
11x11	17,5	143	5	009370011
12x12	19,0	148	5	009370012
13x13	19,5	154	5	009370013
14x14	21,5	167	5	009370014
15x15	22,5	182	5	009370015
16x16	24,5	193	5	009370016
17x17	26,0	198	5	009370017
18x18	26,5	215	5	009370018
19x19	29,0	220	5	009370019
20x20	30,5	222	3	009370020
21x21	30,5	236	3	009370021
22x22	32,5	250	2	009370022
23x23	33,5	256	2	009370023
24x24	35,0	272	2	009370024
25x25	36,5	282	2	009370025
26x26	37,5	296	2	009370026
27x27	39,0	296	2	009370027
28x28	39,0	314	2	009370028
30x30	42,5	348	2	009370030
32x32	45,5	364	2	009370032



937/S11	1	009370080
6-7-8-10-11-12		
13-14-17-19-22 mm		
937/S17	1	009370081
6-7-8-9-10-11-12		
13-14-15-16-17		
18-19-20-21-22 mm		

940

tommy bars for tubular wrenches items 930 and 935



	mm	L		
	mm	mm		
940/1	6+13	100	5	009400001
940/2	14+22	170	5	009400002
940/3	21+32	290	5	009400003

941

hexagon / bi-hex socket wrenches, with high torque handles

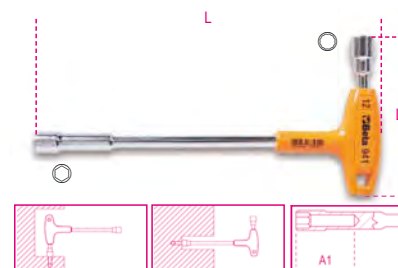

mm	L	L1	A1		
mm	mm	mm	mm		
7x7	200	91	35	2	009410107
8x8	220	107	50	2	009410108
9x9	220	109	50	2	009410109
10x10	236	111	50	2	009410110
11x11	236	114	50	2	009410111
12x12	255	122	50	2	009410112
13x13	255	124	55	2	009410113



941/S7	1	009410170
7-8-9-10-11-12-13 mm		

942BX

hi-torque hexagon nut spinners
short series



UNI 6750

mm	L	L1	A1		
mm	mm	mm	mm		
4	190	70	13,0	5	009420003
5	190	70	14,0	5	009420004
5,5	190	70	12,5	5	009420005
6	190	70	14,5	5	009420006
7	190	70	15,5	5	009420007
8	202	70	18,5	5	009420008
9	202	70	19,5	5	009420009
10	202	70	20,5	3	009420010
11	202	70	21,5	3	009420011
12	202	70	22,5	3	009420012
13	202	70	23,5	3	009420013
14	202	70	24,5	3	009420014



942BX/S12
4-5-5,5-6-7-8-9
10-11-12-13-14 mm

943BX

hi-torque hexagon nut spinners
long series



ISO 2236 UNI 6750

mm	L	L1	A1		
mm	mm	mm	mm		
4	270	150	13,0	5	009430003
5	270	150	14,0	5	009430004
5,5	270	150	12,5	5	009430005
6	270	150	14,5	5	009430006
7	270	150	15,5	5	009430007
8	282	150	18,5	5	009430008
9	282	150	19,5	5	009430009
10	282	150	20,5	3	009430010
11	282	150	21,5	3	009430011
12	282	150	22,5	3	009430012
13	282	150	23,5	3	009430013
14	282	150	24,5	3	009430014



943BX/S12
4-5-5,5-6-7-8-9
10-11-12-13-14 mm



943BX/D6
5-6-7-8-10-13 mm

943FL

flexible hexagon nut spinners
with handles



mm	L	L1	Ø		
mm	mm	mm	mm		
5	265	150	8	2	009430304
5,5	265	150	8	2	009430305
6	265	150	9	2	009430306
7	265	150	11	2	009430307
8	265	150	12	2	009430308
10	290	175	14	2	009430310



943FL/S6
5-5,5-6-7-8-10 mm

944BX

deep, hi-torque hexagon nut spinners
long series



ISO 2236 UNI 6750

mm	L	L1	A1		
mm	mm	mm	mm		
4	245	125	20	3	009440003
5	245	125	25	3	009440004
5,5	245	125	30	3	009440005
6	245	125	35	3	009440006
7	245	125	35	3	009440007
8	257	125	50	3	009440008
9	257	125	50	3	009440009
10	257	125	50	3	009440010
11	257	125	50	3	009440011
12	257	125	50	3	009440012
13	257	125	55	3	009440013
14	257	125	55	3	009440014



944BX/S12
4-5-5,5-6-7-8-9
10-11-12-13-14 mm



944BX/D6
5-6-7-8-10-13 mm

949

deep T-handle socket wrenches

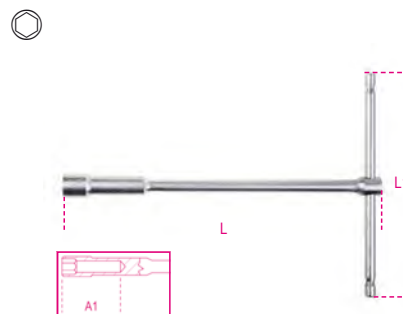

mm	L	L1	A1		
mm	mm	mm	mm		
8	220	160	50	2	009490008
10	230	160	50	2	009490010
12	240	175	50	2	009490012
13	244	175	55	2	009490013
14	250	190	55	2	009490014
17	264	200	60	2	009490017



949/S6
8-10-12-13-14-17mm



950

T-handle hexagon socket wrenches

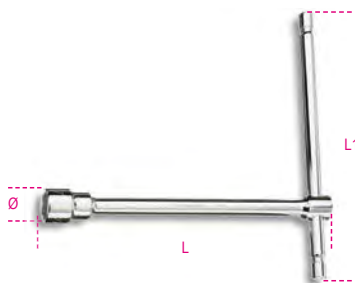

UNI 6742 DIN 3112

mm	L	Ø	L1		
6	210	10,1	145	3	009500006
7	212	11,2	145	3	009500007
8	220	12,4	160	3	009500008
9	223	13,5	160	3	009500009
10	230	14,9	160	3	009500010
11	233	16,1	160	3	009500011
12	240	17,5	175	3	009500012
13	244	19,7	175	3	009500013
14	250	20,1	190	3	009500014
15	254	21,5	190	3	009500015
16	260	22,7	200	3	009500016
17	264	24,1	200	3	009500017
19	274	26,6	230	3	009500019
22	290	29,9	290	2	009500022
24	300	32,2	320	2	009500024
27	315	36,2	370	2	009500027



950/S9 7-8-10-11-12 13-14-17-19 mm	1	009500079
950/S14 6-7-8-9-10-11-12-13 14-15-16-17-19-22 mm	1	009500082

951

T-handle wrenches with three hexagon male ends



mm	L	L1	Ø		
2	125	63	4,0	5	009510521
2,5	150	63	4,0	5	009510525
3	150	63	4,0	5	009510530
3,5	175	76	5,5	5	009510535
4	175	76	5,5	5	009510540
4,5	195	87	6,5	5	009510545
5	195	87	6,5	5	009510550
6	215	99	8,0	5	009510560
7	230	109	9,0	5	009510570
8	250	122	10,0	5	009510580
9	265	132	11,0	5	009510590
10	280	142	12,0	5	009510610
12	305	160	15,0	3	009510620
14	330	178	17,0	3	009510640



951/S6 2,5-3-4-5-6-8 mm	1	009510687
951/S8 2-2,5-3-3,5-4-4,5-5-6 mm	1	009510693
951/S14 5-6-7-8-9-10-12-14 mm	1	009510695



951/SP6 3-4-5-6-8-10 mm	1	009510696
951/SPV	1	009510697

951AS

T-handle wrenches with three hexagon male ends

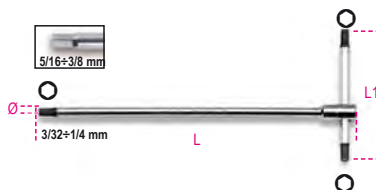

"	L	L1	Ø		
3/32	125	63	4,0	2	009510750
7/64	150	63	4,0	2	009510751
1/8	150	63	4,0	2	009510752
9/64	175	76	5,5	2	009510753
5/32	175	76	5,5	2	009510754
3/16	195	86	6,5	2	009510755
7/32	215	99	8,0	2	009510757
1/4	230	109	9,0	2	009510758
5/16	250	122	10,0	2	009510759
3/8	280	142	12,0	2	009510760



951AS/S6X 1/8-3/16-7/32-1/4-5/16-3/8	1	009510771
--	---	-----------

951TX

T-handle wrenches with three male ends for Torx® head screws



mm	L	L1	Ø		
T6	125	63	4	3	009510806
T7	125	63	4	3	009510807
T8	125	63	4	3	009510808
T9	125	63	4	3	009510809
T10	150	63	4	3	009510810
T15	150	63	4	3	009510815
T20	175	76	5	3	009510820
T25	175	76	5	3	009510825
T27	195	87	6	3	009510827
T30	195	87	6	3	009510830
T40	215	99	7	3	009510840
T45	230	109	8	3	009510845
T50	250	122	9	3	009510850



951TX/S6 T8-T10-T15-T20-T25-T30	1	009510866
951TX/S13 T6-T7-T8-T9-T10-T15-T20-T25 T27-T30-T40-T45-T50	1	009510863

952

T-handle wrenches with swivelling hexagon sockets

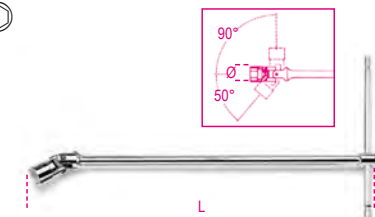

UNI 6743

mm	Ø	L		
6	9,5	395	5	009520006
7	10,7	395	5	009520007
8	12,1	395	5	009520008
9	13,2	395	5	009520009
10	14,6	400	5	009520010
11	15,8	400	5	009520011
12	17,0	400	5	009520012
13	18,7	432	5	009520013
14	19,7	432	5	009520014
15	20,9	450	3	009520015
16	22,0	450	3	009520016
17	23,4	450	3	009520017
18	24,7	450	3	009520018
19	26,0	500	3	009520019
20	27,4	500	3	009520020
21	28,5	500	3	009520021
22	29,7	500	3	009520022
24	32,4	500	3	009520024



952/S7	1	009520074
8-10-11-13-14-17-19 mm		
952/S10	1	009520080
7-8-10-11-12-13-14-15-17-19 mm		
952/S18	1	009520083
6-7-8-9-10-11-12-13-14-15-16-17-18-19-20-21-22-24 mm		

852



852	79,85
------------	-------

952AS

T-handle wrenches with swivelling hexagon sockets

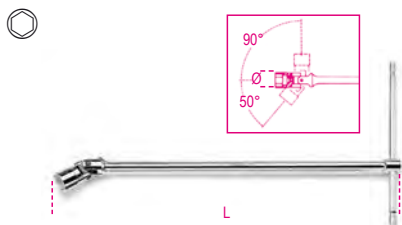

mm	Ø mm	L mm		
1/4	9,5	395	2	009520256
5/16	12,1	395	2	009520258
3/8	14,6	400	2	009520260
7/16	15,8	400	2	009520261
1/2	18,7	432	2	009520263
9/16	19,7	432	2	009520264
5/8	22,0	450	2	009520266
11/16	23,4	450	2	009520267
3/4	26,0	500	2	009520269

952L

T-handle wrenches with swivelling hexagon sockets, long series

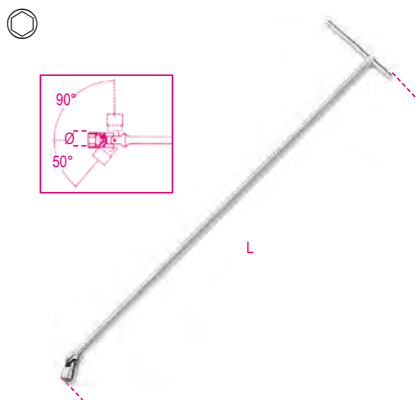

mm	Ø mm	L mm		
10	14,6	930	1	009520410
12	17,0	1063	1	009520412
13	18,7	1100	1	009520413
14	19,7	1100	1	009520414

mm	Ø mm	L mm		
15	20,9	1100	1	009520415
16	22,0	1100	1	009520416
17	23,4	1100	1	009520417
18	24,7	1100	1	009520418
19	26,0	1100	1	009520419

952FTX

T-handle wrenches with swivelling socket, for Torx® head screws

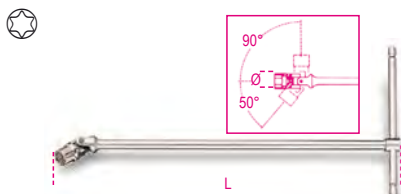

mm	Ø mm	L mm		
E6	8	392	2	009520106
E7	9	392	2	009520107
E8	10	395	2	009520108
E10	13	400	2	009520110
E12	15	440	2	009520112
E14	17	490	2	009520114
E16	19	490	2	009520116
E18	21	490	2	009520118
E20	23	490	2	009520120



952FTX/S9	1	009520141
E6-E7-E8-E10-E12-E14-E16-E18-E20		

953

T-handle wrenches with swivelling hexagon male ends

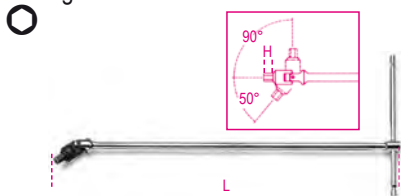

UNI 6754

mm	H mm	L mm		
3	5	395	5	009530130
3,5	6	395	3	009530135
4	6	395	5	009530140
4,5	7	395	3	009530145
5	7	395	5	009530150
6	9	400	5	009530160
7	10	425	3	009530170
8	11	425	5	009530180
10	13	440	5	009530200



953/S5	1	009530305
3-4-5-6-8 mm		
953/S9	1	009530301
3-3,5-4-4,5-5-6-7-8-10 mm		

953TX

T-handle wrenches with swivelling end for Torx® head screws

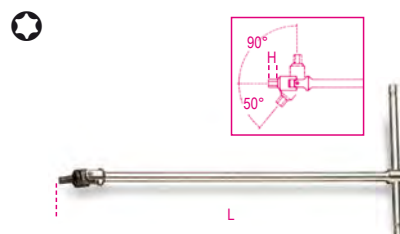

mm	H mm	L mm		
T20	11	396	2	009530020
T25	11	396	2	009530025
T27	11	396	2	009530027
T30	13	400	2	009530030
T40	13	400	2	009530040
T45	13	426	2	009530045
T50	14	442	2	009530050
T55	14	442	2	009530055

953TX/S8	1	009530060
T20-T25-T27-T30-T40-T45-T50-T55		



955

tubular spark-plug wrench chrome-plated, hexagon end

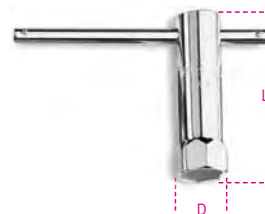

mm -"	D mm	L mm		
16	21	86	3	009550016
5/8				
20,8	29	86	3	009550021
13/16				

956C

1/2" square drive spark plug sockets chrome-plated, hexagon ends



ISO 11168

mm -"	Ø mm	L mm		
14	18,8	70	3	009560008
9/16				
16	21,4	70	3	009560010
5/8				
17,8	23,6	70	3	009560011
11/16				
20,8	27,0	70	3	009560012
13/16				

956E

3/8" square drive spark plug sockets
chrome-plated, hexagon ends



ISO 11168

mm -"	Ø mm	L mm		
14	18,8	70	3	009560018
9/16				
16	21,4	70	3	009560020
5/8				
17,8	23,6	70	3	009560021
11/16				
20,8	27,0	70	3	009560022
13/16				

956F

3/8" square drive spark plug sockets



mm -"	Ø mm	L mm		
14	18,8	70	1	009560114
9/16				
16	20,5	70	1	009560116
5/8				

956L

1/2" square drive spark plug sockets,
bi-hex ends, long series



mm -"	Ø mm	L mm		
14	20,2	250	2	009560214
9/16				
16	24,0	250	2	009560216
5/8				
17,8	24,0	250	2	009560217
11/16				
20,8	28,5	250	2	009560221
13/16				

957

T-handle spark plug wrenches
with swivelling sockets

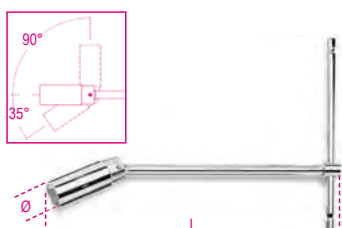

ISO 11168

mm -"	Ø mm	L mm		
16	21,4	275	3	009570000
5/8				
20,8	27,0	275	3	009570001
13/16				

959

T-handle spark plug wrenches
with swivelling sockets, standard series

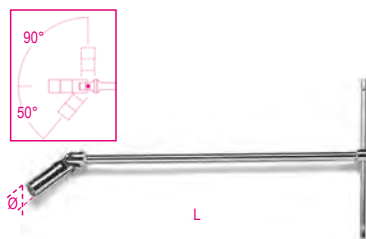

ISO 11168

mm -"	Ø mm	L mm		
14	18,8	483	3	009590009
9/16				
16	21,4	483	3	009590010
5/8				
20,8	27,0	527	3	009590011
13/16				

959R

rubber inset and spare spring
for items 956C - 956E - 957 - 959

959R/14	956C/14-956E/14	3	009590223
959R/16	956C/16-956E/16	3	009590224
959R/17,8	956C/17,8-956E/17,8	3	009590225
959R/20,8	956C/20,8-956E/20,8	3	009590226
	957/20,8-959/20,8-959L		

960

1/2" square drive socket
for Diesel engine injectors



mm	Ø mm	L mm		
27	36,5	77	2	009600027

960A

1/2" square drive socket
for Diesel engine injectors

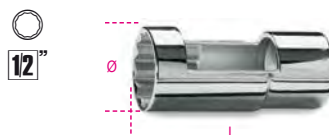

mm	Ø mm	L mm		
27	36,5	77	2	009600017

960BT

sockets for injector electrical connections



mm	Ø mm	L mm		
25	37,0	78	1	009600125
27	39,7	78	1	009600127
29	42,0	78	1	009600129
30	43,0	78	1	009600130

960BT/B

sockets for injector electrical connections

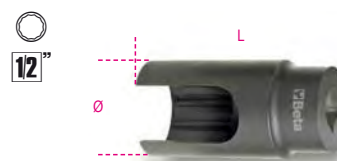

mm	Ø mm	L mm		
29	38,5	77	1	009600128

960F

socket for nozzle holder ring nuts



mm	Ø mm	Ø1 mm	Ø2 mm	L mm		
28,3	22	32	22		1	009600148

960G

socket for Diesel engine injectors
of Mercedes-Benz trucks



mm	Ø1 mm	Ø2 mm	L mm		
28,5	22	32	122	1	009600151

960L

socket for nozzle holder ring nuts



mm	Ø1 mm	L mm		
30	22	122	1	009600153

960M

socket for nozzle holder ring nuts

12"



Ø mm	Ø1 mm	L mm	1	009600154
28,5	22	72		

960H/C4

set of sockets for nozzle holder ring nuts



960H/C4 1 009600152

960S

1/2" square drive socket for Diesel engine injectors

12"



mm	Ø mm	L mm	1	009600022
22	30	82		

960SL

sockets for Lambda probes with 1/2" female square drives

12"



960SL85	Ø mm	L mm	2	009600085
○ 22xL= 85 mm	33			
960SL110	Ø mm	L mm	2	009600110
○ 22xL= 110 mm	33			

960SN

Diesel engine glow plug wrenches

14"

3/8"



mm	Ø mm	□ mm	L mm	2	009600834
8	12,0	1/4	60		
9	13,3	1/4	60		
10	14,5	3/8	70		
11	15,8	3/8	70		
12	17,0	3/8	70		

960T/C11

assortment of sockets for removing/installing sensors

Kit contents:

- 1 double ended hexagon socket, size 1" - 11/16" for oil pressure sensors
- 1 open end hexagon socket, 29 mm, for oxygen sensors
- 1 open end bi-hex socket, 27 mm, for injectors
- 1 open end hexagon socket, 22 mm, for vacuostats
- 1 open end hexagon socket, 22 mm, 80 mm long, for oxygen sensors
- 1 open end hexagon socket, 22 mm, 90 mm long, for oxygen sensors
- 1 open end hexagon socket, 22 mm, compact, 30 mm long, for oxygen sensors
- 1 open end hexagon socket, 22 mm, compact, 50 mm long, for oxygen sensors
- 1 open end hexagon and bi-hex socket, 22 mm, compact, 34 mm long, for oxygen sensors
- 1 open end hexagon socket, 22 mm, tube-shaped
- 1 tap M18x1.5

12"

3/8"

12"

12"



○ 22 - 29 mm

960T/C11 1 009600031

≡ 330x270x25 mm

960T/A

open end hexagon socket, 29 mm, for oxygen sensors

12"

12"



mm	L mm	1	009600032
29	90		

960T/B

open end bi-hex socket, 27 mm, for injectors

12"

12"



mm	L mm	1	009600033
27	85		

960T/C

open end hexagon socket, 22 mm, for vacuostats

12"

12"



mm	L mm	1	009600034
22	88		

960T/D

open end hexagon socket, 22 mm, 90 mm long, for oxygen sensors

3/8"

12"



mm	mm	L mm	1	009600035
22	25	90		

960T/E

open end hexagon socket, 22 mm, 80 mm long, for oxygen sensors

3/8"

12"



mm	mm	L mm	1	009600036
22	25	80		

960T/F

double ended hexagon socket, size 1" - 1 1/16", for oil pressure sensors

3/8"

12"



1 - 1 1/16"	mm	L mm	1	009600037
	28	74		

960T/G

open end hexagon socket, 22 mm, tube-shaped

12"

12"



mm	mm	L mm	1	009600038
22	25	98		

960T/H

open end hexagon and bi-hex socket, 22 mm, compact, 34 mm long, for oxygen sensors



mm	L1 mm	L2 mm	1	009600039
22	34	55		

960T/I

open end socket, 22 mm, compact, 30 mm long, for oxygen sensors



mm	L1 mm	L2 mm	1	009600040
22	30	81		

960T/L

open end socket, 22 mm, compact, 50 mm long, for oxygen sensors



mm	L1 mm	L2 mm	1	009600041
17	50	58		

960T/M

tap M18x1.5



mm	L mm	1	009600042
21	50		

960/22EP

double head swivel socket wrench for Lambda probes
Double hexagon/bi-hex and 180° joint result in remarkable versatility



L mm	mm	mm	1	009600052
300	22	22		

960/C6

3/8" female drive hexagon sockets for removing/installing exhaust gas temperature sensors

- Kit contents:
- 3 short sizes, 13, 14, 17 mm
 - 3 long sizes, 13, 14, 17 mm



960/C6	1	009600055
170x120x50 mm		

960/D

open hexagon wrenches, long series, for removing/installing exhaust gas temperature sensors



mm	1	009600073
13		
14		009600074
17		009600077

960YP

open offset hexagon wrenches for removing/installing exhaust gas temperature sensors



mm	1	009600063
13		
14		009600064
17		009600067

960AVE

device for testing common rail diesel electrical injectors



960AVE	1	009600245
430x310x50 mm - 2,0 kg		

960CMB

instrument for controlling compression on petrol engines



Bar	4÷17	1	009600250
440x370x100 mm - 2,2 kg			

960CMB/R2

spare cards for item 960CMB



960CMB/R2	1	009600252
-----------	---	-----------

960CMD

instrument for controlling compression on Diesel engines



Bar
8÷40
440x370x100 mm - 2,4 kg
1 009600270

960CMD/R1

spare cards for item 960CMD



960CMD/R1
1 009600271

960EPC

set of tools for removing glow plug electrode

M8x1 - M9x1 - M10x1 - M10x1,25



960EPC
270x230x80 mm - 900 g
1 009600790

960EPC/L

set of tools for removing glow plug electrode face

M8x1 - M9x1 - M10x1 - M10x1.25



960EPC/L
270x230x80 mm - 2 kg
1 009600890

960E-PI/P

injector washer extractor

• Male thread M10 for use with sliding hammer (Beta 1540)



960E-PI/P
300x90x60 mm
1 009600706

960KC-M8/M9/M10

assortment of tools for removing broken or damaged glow plugs

• For spark plugs with threads M8-M9-M10



960KC-M8/9/10
380x290x50 mm - 2,3 kg
1 009600801

960KPC

reversible impulse extractor with adjustable torque for glow plugs

Torque can be adjusted in 4 positions:
10-20-30-40 Nm

1/4"
CE



960KPC
8-9-10-11-12 mm
420x185x60 mm - 2,8 kg
1 009600780

960UC

tool set for removing stuck M8-M9-M10 glow plugs with deformed tips



960UC
270x230x80 mm - 2,6 kg
1 009600900

960P

pressure/depressure tester with accessories and adaptors



960P
350x320x95 mm - 1,9 kg
1 009600777

960PI

assortment of reamers for cleaning injector seats
in plastic case

For removing residues from injector seats

- Flat reamer, Ø 19 - 15 mm, for universal injectors
- Flat reamer, Ø 17 - 17 mm, for Delphi/Bosch injectors (BMW/PSA/Renault/Ford)
- Flat reamer, Ø 19 - 17 mm, for Bosch injectors (Mercedes CDI).
- Angled reamer, Ø 21 - 17 mm, for Fiat/Iveco injectors.
- Handle



960PI 1 009600215

≡ 250x130x50 mm - 600 g

960PI/C19

assortment of 19 tools
for cleaning injector seats

Kit contents:

- 11 flat reamers, Ø:
14/14 mm - 15.5/15.5 mm - 15/19 mm - 17/19 mm - 17/17.5 mm
17/19 mm - 17/19.5 mm - 17/20 mm - 18/21 mm - 19 mm - 20/21 mm
- 4 angled reamers, Ø:
15.5/15.5 mm - 17/17 mm - 17.5/20.5 mm - 17/21 mm
- Handle and cutter accessories



960PI/C19 1 009600217

≡ 360x230x60 mm

960PI/S

kit for cleaning injector seats

Kit contents:

- 3 steel brushes, Ø 18, 22, 25 mm, for cleaning injector seats
- 2 brushes, Ø 14 and 16 mm, for cleaning injector seat bottoms
- 6 caps for closing hole connecting with combustion chamber
- 1 brush for cleaning hole connecting with combustion chamber
- 1 flexible bit holder with handle



960PI/S 1 009600214

≡ 360x140x50 mm - 700 g

960RPI

blowing tool for injectors seat cleaning

for M8x1 - M9x1 - M10x1 - M10x1.25 glow plugs



960RPI 1 009600940

960PMC

Diesel injector test and calibrating
hand pump



Bar Max. 600 1 009600200

960AVL

vapour extractor



Bar Max. 6 1 009600210

961P6

electronic videoscope
with flexible probe



- Supports SD cards (8 GB)
- Supports flash memories (8 GB)
- Internal memory: 128M
- TV-OUT feature
- Supports video formats (MP4, AVI, 3GP)
- 4 LEDs
- Power supplied by USB port (built-in battery)

SPECIFICATIONS

- Sensor pixels: 640x480
- Maximum resolution: 320x240
- Probe length: 1 m
- Camera diameter: 6 mm
- Video formats: MPEG4, 3GP, AVI, ASF.
- Photo formats: JPEG
- Shooting angle: 0÷180°
- Data output: USB cable and SD card
- Power supply: 3.7V 2000 mAh battery

961P6 1 009610000

961P6/S

flexible probes, 6 mm



	L mm	
961P6/S1	1000	1 009610006
961P6/S2	2000	1 009610262
961P6/S3	3000	1 009610263

962

tyre levers



L mm	A mm	
300	21	5 009620003
400	25	5 009620004
500	27	3 009620005
600	27	3 009620006



962P

tyre levers with non-scratch rubber protection



962M

tyre removal/installation tool

particularly recommended for runflat tyres and lower shoulder models

- non-scratch rim locking jaws
- tyre removal lever seat



962M 1 009620501

963

pry bar with pointed and flat bent ends



964

pry bar with pointed and leverage ends



965

pry bars with flat curved ends

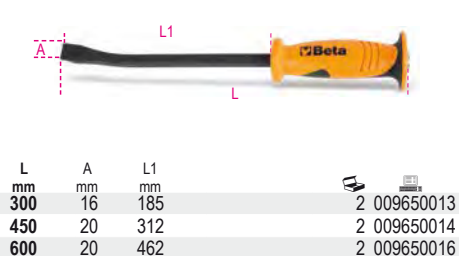

965/S3 1 009650019

966/C3

set of 3 levers with articulated, flat, curved heads



720LS

impact sockets, long, slim series



969B

hub nut locking socket

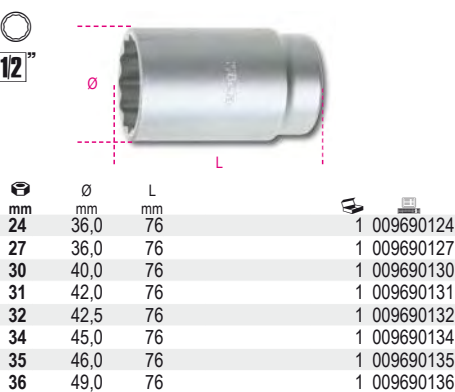

969/C5

set of 5 hub nut locking sockets in plastic case



970EA

impact sockets for axle nuts



970EB

impact sockets for axle nuts



970Q

impact sockets for rectangular nuts



970B

socket for locking Fiat Daily hub nuts

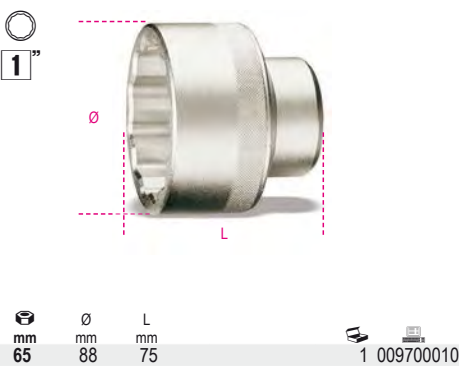

970C

octagonal impact sockets for locking hub nuts



mm	□ - ○		
80	41 mm	1	009700808
95	3/4"	1	009700815
100	3/4"	1	009700820
109	41 mm	1	009700829
115	3/4"	1	009700835
120	41 mm	1	009700840

9700T

oval impact sockets for locking trailer hub nuts



L mm	L1 mm	□ - ○		
65	61	3/4"	1	009700165
80	73	3/4"	1	009700180
96	90	3/4"	1	009700196
111	104	41 mm	1	009700211

971TSP

tyre pressure sensor tool



SPECIFICATIONS

- reading of TPMS sensor information, including: sensor ID, inflation pressure, temperature, battery state
- sensor activation
- universal sensor programming

The tool has a database which supports repair operations, including:

- driving torques
- codes of original spare parts and compatible universal sensors

971TSP		1	009710025
63x142x30 mm			

971/C8

torque screwdriver with accessories for controlled tightening of tyre valves with pressure control system



971/C8		1	009710108
---------------	--	---	-----------

	583/6	1,2+6 Nm
	892/0	
	862TX	T10-T15-T20
	900L	11-12 mm
	986 78	

973

kit of 4 nylon wheel covers

suitable for the following rims:
14" ÷ 18" item number 009730014
19" ÷ 22" item number 009730019



- preserves and protects wheel from scratches and dust
- during storage, it prevents early deterioration of rubber polymers in summer or winter tyres
- an icon allows wheel position (right/left front or right/left rear) identification
- provided with handles for convenient transportation
- fabric: nylon, washable

973 14"÷18"	1	009730014
973 19"÷22"	1	009730019

978 - 979

four-way hexagon wheel nut wrenches

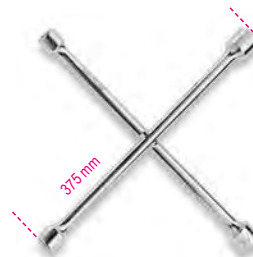

UNI/ISO 6788 DIN 3119

978		2	009780001
17x19x21x22 mm			
979		2	009790001
17x19x22x1 1/2 mm			

982

four-way hexagon wheel nut wrench



UNI/ISO 6788 DIN 3119

24x27x32x34 mm	1	009820001
-----------------------	---	-----------

984

wheel nut plastic cap pliers



L mm	H mm		
195	4	1	009840005

985/B7

assortment of 7 guide pins for wheel installation

- Included sizes:
- M12X1.25 male
 - M12x1.25 female
 - M12x1.5 male
 - M12x1.5 female
 - M14x1.25 male
 - M14x1.5 male
 - M16x1.5 male



985/B7	1	009850007
---------------	---	-----------

985M

male guide pins for wheel installation



	L mm		
985M M12X1,25	150	1	009850101
985M M12X1,50	150	1	009850102
985M M14X1,25	150	1	009850103
985M M14X1,50	150	1	009850104
985M M16X1,50	150	1	009850105

985F

female guide pins for wheel installation



	L mm		
985F M12X1,25	150	1	009850106
985F M12X1,50	150	1	009850107

986 48

tyre valve screwdriver,
short model
automatic valve retention



L mm	L1 mm		
18	48	1	009860048

986 78

tyre valve screwdriver
automatic valve retention



L mm	L1 mm		
18	78	1	009860078

986PT

tyre valve screwdriver,
precalibrated, 0.4 Nm

automatic valve retention
slip mechanism prevents
valve core gasket
from getting damaged



L mm	L1 mm		
19	120	1	009860140

987

tyre valve lever
with rubber protection



L mm			
310		1	009870001

987AR

tyre valve lever
with non-scratch fulcrum
• rubber and nylon fulcrum
for alloy and iron rims
• valve quick coupling,
does not require screwing



L mm			
305		1	009870021

987P

tyre valve lever
made of plastic

Handle accommodates screwdriver to work on
mechanism inside valve



L mm			
335		1	009870011

988/K4

set of 4 scratchproof plastic flat chisels



988/K4			
A= 19-21-25-38 mm		1	009880104

989

wheel balancing weight tool

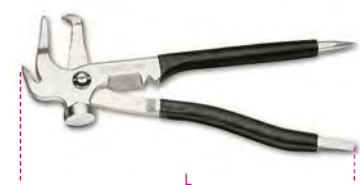

L mm			
250		2	009890001

989A

pliers for removing wheel balancing adhesive
weights



Nose profile specially designed to
remove weights without making contact with rim

989A	L mm		
	220	1	009890011

990

straight thin knurled point spring
tweezers made from stainless steel
bright finish



L mm			
130		5	009900001

991

bent thin knurled point spring tweezers
made from stainless steel, bright finish



L mm			
130		5	009910001

992

straight thin knurled point pin spring tweezers
made from stainless steel bright finish



L mm			
150		5	009920001

993

bent thin knurled point pin spring tweezers
made from stainless steel
bright finish



L mm			
145		5	009930001

993PL

bent thin knurled point pin spring tweezers made from stainless steel PVC-coated



L mm 150 3 009930010

993G

pin spring tweezers, curved round ends, knurled made from stainless steel bright finish



L mm 160 3 009930030

994

straight large knurled point spring tweezers made from stainless steel bright finish



L mm 150 5 009940001

994PL

straight large knurled point spring tweezers made from stainless steel PVC-coated



L mm 150 3 009940010

994TF

spring tweezers, acid and magnetic resistant, large round noses, strong and knurled ends made from stainless steel semi-bright finish



L mm 150 3 009940020

996

straight end spring tweezers with wide tips made from stainless steel bright finish



L mm 150 5 009960001

998

cross knurled end spring tweezers made from stainless steel bright finish



L mm 155 5 009980001

999

flat round end spring tweezers, acid and magnetic resistant made from stainless steel semi-bright finish



L mm 115 3 009990011

999A

extra slim short end spring tweezers, acid and magnetic resistant made from stainless steel semi-bright finish



L mm 120 3 009990015

999B

strong straight end spring tweezers, acid and magnetic resistant made from stainless steel semi-bright finish



L mm 120 3 009990017

999C

extra slim straight end spring tweezers, acid and magnetic resistant made from stainless steel semi-bright finish



L mm 110 3 009990019

999D

extra slim angled end spring tweezers, acid and magnetic resistant made from stainless steel semi-bright finish



L mm 115 3 009990021

999E

extra slim curved end spring tweezers, acid and magnetic resistant made from stainless steel semi-bright finish



L mm 120 3 009990023

999G

extra slim straight end spring tweezers, acid and magnetic resistant with stop mechanism made from stainless steel semi-bright finish



L mm 140 3 009990027

999/B6

set of 6 spring tweezers, acid and magnetic resistant



999/B6 999-999A-999B 999C-999D-999E 1 009990050

1002

self-locking round end knurled tool made of stainless steel



L
mm
160

2 010020001

1008

long flat knurled nose pliers, slip-proof double layer PVC coated handles



ISO 5745

L mm 160 L1 mm 51,5

5 010080006

1008BM

long flat knurled nose pliers bi-material handles



ISO 5745

L mm 160 L1 mm 51,5

3 010080036

1009

extra-long knurled nose pliers, slip-proof double layer PVC coated handles



ISO 5745

L mm 160 L1 mm 56,5

2 010090006

1009L/A

extra long needle knurled nose pliers, for special operations, slip-proof double layer PVC coated handles



L mm 283 L1 mm 80

2 010090008

1009L/B

curved extra long knurled nose pliers, 45°, for special operations, slip-proof double layer PVC coated handles



L mm 273 L1 mm 73

2 010090009

1009L/C

bent extra long knurled nose pliers, 90°, for special operations, slip-proof double layer PVC coated handles



L mm 253 L1 mm 45

2 010090010

1009L/D

extra-long, knurled double swivel nose pliers, slip-proof double layer PVC coated handles



L mm 342 L1 mm 71

1 010090058

1009L/DP

curved extra-long knurled double swivel nose pliers, 45°, slip-proof double layer PVC-coated handles



L mm 336 L1 mm 66

1 010090059

1010

long round knurled nose pliers, slip-proof double layer PVC coated handles



ISO 5745

L mm 160 L1 mm 51,5

2 010100006

1010BM

long round knurled nose pliers bi-material handles



ISO 5745

L mm 160 L1 mm 51,5

2 010100036

1031/S4

set of 4 circlip pliers



1031/S4 1 010310000

1032 180 ○ 19 ÷ 60 mm
1034 170 ○ 19 ÷ 60 mm
1036 175 ● 19 ÷ 60 mm
1038 175 ● 19 ÷ 60 mm

1032

internal circlip pliers, straight pattern PVC-coated handles



UNI 7914 DIN 5256

L mm 140x0,9 140x1,3 180 225 300

∅ mm 8÷12 12÷25 19÷60 40÷100 85÷200

5 010320013
5 010320014
5 010320017
3 010320021
2 010320028

1033

internal circlip pliers, bent pattern,
45° PVC-coated handles



UNI 7914 DIN 5256

L mm	∅ mm		
140x0,9	8÷12	5	010330013
140x1,3	12÷25	5	010330014
180	19÷60	5	010330017
225	40÷100	3	010330021

1034

internal circlip pliers, bent pattern,
90° PVC-coated handles



UNI 7914 DIN 5256

L mm	∅ mm		
130x0,9	8÷12	5	010340013
130x1,3	12÷25	5	010340014
170	19÷60	5	010340017
210	40÷100	3	010340021
290	85÷200	2	010340028

1034L

90° curved long nose pliers
for elastic safety rings for holes,
PVC-coated handles



L mm	∅ mm		
190	40÷100	2	010340320

1036

external circlip pliers, straight pattern
PVC-coated handles



UNI 7915 DIN 5254

L mm	∅ mm		
140x0,9	3÷10	5	010360013
140x1,3	10÷25	5	010360014
175	19÷60	5	010360017
225	40÷100	3	010360021
300	85÷200	2	010360028

1037

external circlip pliers, bent pattern,
45° PVC-coated handles



UNI 7915 DIN 5254

L mm	∅ mm		
140x0,9	3÷10	5	010370013
140x1,3	10÷25	5	010370014
175	19÷60	5	010370017
225	40÷100	3	010370021

1038

external circlip pliers, bent pattern,
90° PVC-coated handles

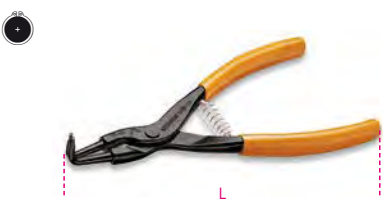

UNI 7915 DIN 5254

L mm	∅ mm		
135x0,9	3÷10	5	010380013
135x1,3	10÷25	5	010380014
175	19÷60	5	010380017
220	40÷100	3	010380021
300	85÷200	2	010380028

1039

straight point pliers for internal
and external circlips PVC-coated handles



L mm	∅ mm	∅ mm		
150	10÷15	6÷25	2	010390015

1558/C4

internal and external snap ring tool,
screw-operated

square drive allows a high force to be applied
in both operating conditions
Supplied tips:
∅ 2.5-3-3.5 mm



	∅ mm	∅ mm		
1558/C4	5,5 ÷ 77	5,5 ÷ 77	1	015580100

330x220x50 mm - 900 g

1044

slip joint pliers overlapping joint
PVC-coated handles

· 9-position model



ISO 8976

L mm	A max mm	L1 mm		
250	48	39	5	010440250

1044F

slip joint pliers
overlapping joint
PVC-coated handles

· 9-position model



ISO 8976

L mm	A max mm	L1 mm		
250	48	39	5	010440015

1046

slip joint pliers overlapping rack-type joint
PVC-coated handles



ISO 8976

L mm	A max mm	L1 mm		
240	28	33	5	010460240
400	107	55	1	010460400

1047

slip joint pliers, push button adjustment



L mm	A max mm	L1 mm		
180	30	29	2	010470180
240	36	35	2	010470240
300	50	48	1	010470300

1047BM

slip joint pliers, push button adjustment, bimaterial handles



L mm	A max mm	L1 mm	
240	36	35	2 010470340

1048

slip joint pliers, boxed joints, slip-proof double layer PVC coated handles

· 9-position model

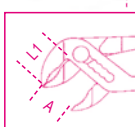

L mm	A max mm	L1 mm	
175	30	29	3 010480010
250	48	39	5 010480015
300	56	47	2 010480020

1048BM

slip joint pliers, boxed joint, bimaterial handles

· new 9-position model



L mm	A max mm	L1 mm	
250	48	39	3 010480215

1048V

slip joint pliers boxed joints, orange lacquered

· new 9-position model

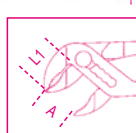

L mm	A max mm	L1 mm	
175	30	29	3 010480110
250	48	39	5 010480115
300	56	47	2 010480120

1050

double adjustment self-locking pliers

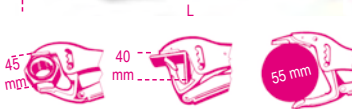

L mm	
220	2 010500022

1051

double adjustment self-locking pliers long jaws

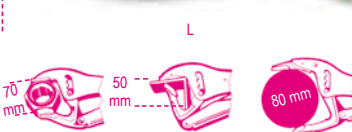

L mm	
255	2 010510025

1051GM

double adjustment self-locking pliers, floating jaw



L mm	
255	2 010510250

1051L

large-capacity double adjustment self-locking pliers



L mm	
270	2 010510100

1051XL

large-capacity double adjustment self-locking pliers, extra-long jaws



L mm	
270	2 010510140

1052

adjustable self-locking pliers, concave jaws



L mm	A1 max mm	
140	22	3 010520014
190	36	3 010520019
240	42	3 010520024
300	55	2 010520030

1053

adjustable self-locking pliers, floating jaw

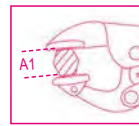

L mm	A1 max mm	
240	35	2 010530024



1054

adjustable self-locking pliers,
straight jaws

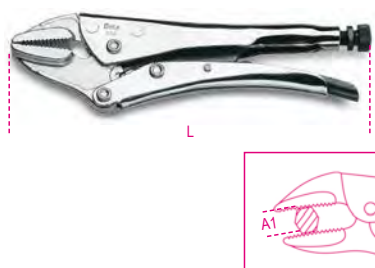

L mm	A1 max mm		
235	40	2	010540022

1055

adjustable self-locking pliers,
curved jaws

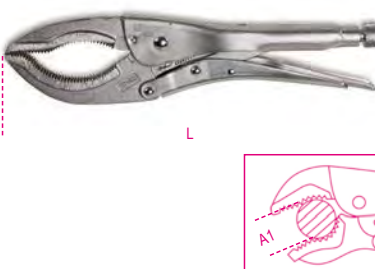

L mm	A1 max mm		
270	75	2	010550027

1056

adjustable self-locking pliers
for refrigeration technicians

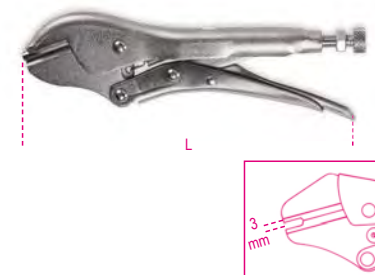

L mm			
195		2	010560017

1057A

automatic self-locking pliers with adjustable
force



L mm			
240		2	010570124

1058

adjustable self-locking pliers,
long jaws

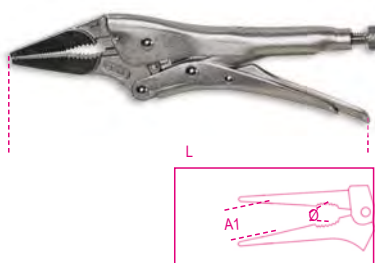

L mm	A1 max mm	Ø max mm		
175	34	26	2	010580017
225	46	31	2	010580025

1059

adjustable self-locking pliers
with one sliding jaw

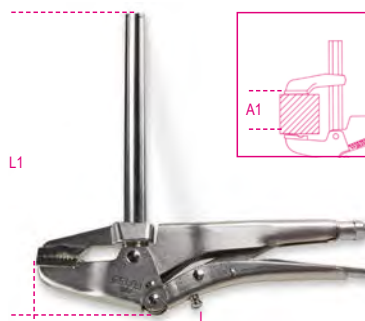

L1 mm	L mm	A1 mm		
160	255	120	1	010590016
270	255	220	1	010590027

1060

adjustable self-locking pliers,
fork-type jaws

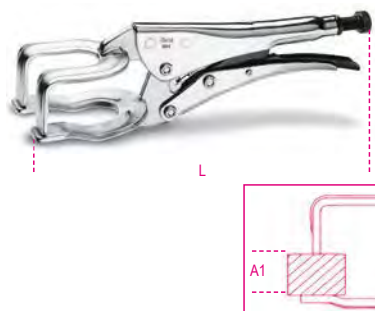

L mm	A1 max mm		
200	50	2	010600020
280	80	2	010600028

1061

adjustable self-locking pliers,
fork-type jaws

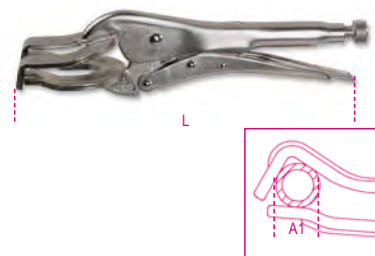

L mm	A1 max mm		
275	80	2	010610027

1062

adjustable self-locking pliers
with C-shaped jaws

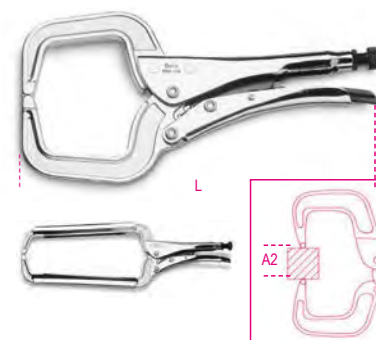

L mm	A2 max mm		
170	50	2	010620017
290	120	2	010620029
460	255	1	010620045

1062AL

adjustable self-locking pliers,
aluminium C-shaped jaws

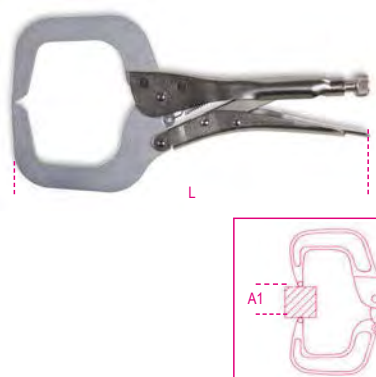

L mm	A1 max mm		
275	88	2	010620327

1062GM

adjustable self-locking pliers
with floating C-shaped jaws

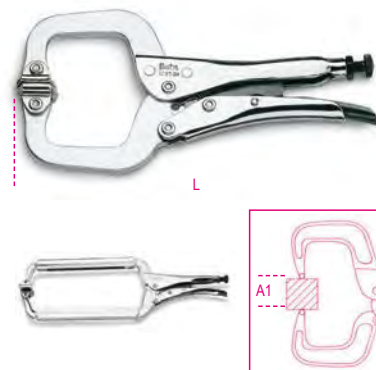

L mm	A1 max mm		
170	45	2	010620217
290	88	2	010620229
460	255	1	010620245

1063

adjustable self-locking pliers
for tinsmiths

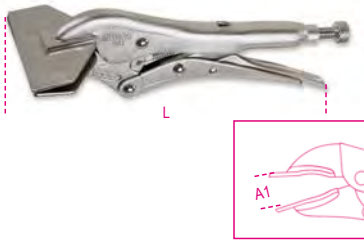

L mm	A1 max mm		
200	31	2	010630021

1064

adjustable self-locking pliers with chain



L mm	Ø mm		
230	150	2	010640023

1065F

hand punch steel punch and matrix



Ø mm	L mm		
5	228	1	010650010
6	228	1	010650015

1065P

hand crimper steel matrix



L mm			
228		1	010650020

1067

adjustable self-locking pliers for pipes,
articulated pipe clamping jaws

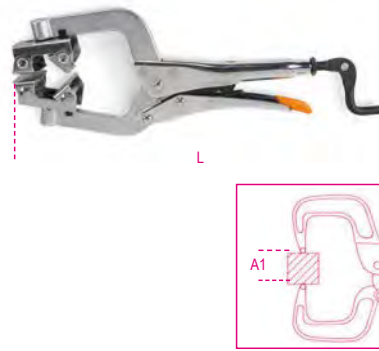

L mm	A1 max mm		
285	76	1	010670285
380	89	1	010670380

1077

straight wide blade tinsmith's pliers,
PVC-coated handles



L mm	A mm	L1 mm		
280	60	53	1	010770026

1078

curved wide blade tinsmith's pliers,
45° PVC-coated handles



L mm	A mm	L1 mm		
280	60	77	1	010780026

1080D

diagonal flush cutting nippers,
slip-proof double layer PVC coated handles

For cutting plastic

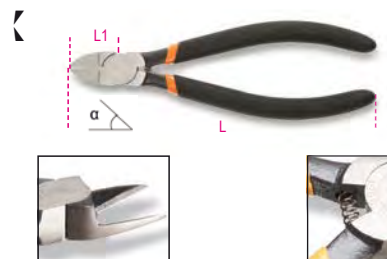

α	L mm	L1 mm		
15°	160	22	3	010800015
45°	160	22	3	010800045

1081

semi-flush cutting nippers,
slip-proof double layer PVC
coated handles
• For micro-mechanics and heavy-duty electronics

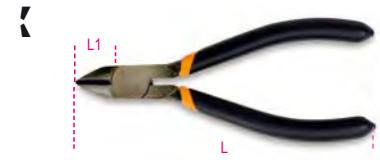

L mm	L1 mm		
125	16	3	010810130

1082

diagonal cutting nippers,
chrome-plated,
slip-proof double layer PVC coated handles

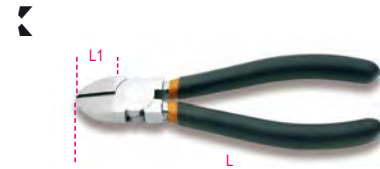

UNI/ISO 5749

L mm	L1 mm	Ø mm		
140	20	1,6	5	010820004
160	22	1,6	5	010820006

1082G

diagonal cutting nippers,
slip-proof double layer PVC coated handles,
industrial finish

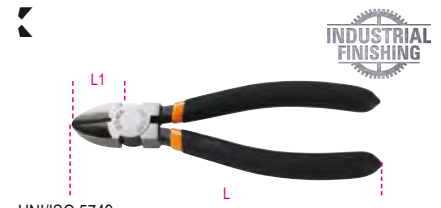

UNI/ISO 5749

L mm	L1 mm	Ø mm		
140	20	1,6	5	010820064
160	22	1,6	5	010820066

1082BM

diagonal cutting nippers,
bi-material handles



UNI/ISO 5749

L mm	L1 mm	Ø mm		
140	20	1,6	3	010820034
160	22	1,6	3	010820036

1082GBM

diagonal cutting nippers,
bi-material handles,
industrial finish



UNI/ISO 5749

L mm	L1 mm	≡ mm		
140	20	1,6	3	010820264
160	22	1,6	3	010820266

1084

heavy duty diagonal cutting nippers,
chrome-plated,
slip-proof double layer PVC coated handles



UNI/ISO 5749

L mm	L1 mm	≡ mm		
160	22	1,6	5	010840006
200	28	2,0	3	010840010

1084G

heavy duty diagonal cutting nippers,
slip-proof double layer PVC coated handles,
industrial finish



UNI/ISO 5749

L mm	L1 mm	≡ mm		
160	22	1,6	5	010840066
200	28	2,0	3	010840070

1084BM

heavy duty diagonal cutting nippers,
chrome-plated,
bi-material handles



UNI/ISO 5749

L mm	L1 mm	≡ mm		
160	22	1,6	3	010840036
200	28	2,0	3	010840040

1084GBM

heavy duty diagonal cutting nippers,
bi-material handles,
industrial finish



UNI/ISO 5749

L mm	L1 mm	≡ mm		
160	22	1,6	3	010840266
200	28	2,0	3	010840270

1088

heavy duty end cutting nippers,
slip-proof double layer PVC coated handles

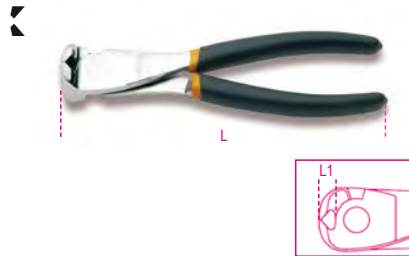

UNI/ISO 5748

L mm	L1 mm	≡ mm		
160	9	1,6	2	010880006
200	11	2,0	2	010880010

1088BM

heavy duty end cutting nippers,
bi-material handles



UNI/ISO 5748

L mm	L1 mm	≡ mm		
160	9	1,6	2	010880036
200	11	2,0	2	010880040

1092V

toggle lever assisted end cutting nippers

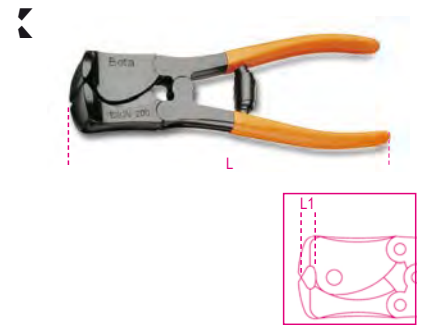

UNI/ISO 5748

L mm	L1 mm	≡ mm		
180	8	2,0	2	010920280
200	9	2,5	2	010920310

1094V

toggle lever assisted
diagonal cutting nippers



UNI/ISO 5749

L mm	L1 mm	≡ mm		
200	23	2,5	2	010940200

1095N

toggle lever assisted
diagonal cutting nippers



L mm	L1 mm	≡ mm		
195	26	1,6	2	010950010

1096

carpenter's pincers



ISO 9243

L mm	L1 mm			
160	21	5	010960016	
200	23	5	010960020	
250	30	5	010960025	



1098

construction worker's pincers



ISO 9242 DIN 5242

L	L1		
mm	mm		
190	12	5	010980190
220	13	5	010980220
250	15	5	010980250
280	18	5	010980280

1098PL

construction worker's pincers,
PVC coated handles



ISO 9242 DIN 5242

L	L1		
mm	mm		
220	13	5	010980320
250	15	5	010980350
280	18	5	010980380

1101

bolt cutter phosphatized blades
and rubber grip handles



L	L		
mm	mm		
300	12	2	011010030
350	14	2	011010035
450	18	1	011010045
600	24	1	011010060
750	30	1	011010075
900	36	1	011010090

L	R = 80		g
	Kgf/mm ²	Ø mm	
300	5	4	745
350	6	5	1043
450	7	6	1537
600	9	7	2540
750	11	8	3870
900	12	9	6170



1101R

spare blades for item 1101



mm	1101		
300	300	1	011010130
350	350	1	011010135
450	450	1	011010145
600	600	1	011010160
750	750	1	011010175
900	900	1	011010190

1102

bolt cutters, small series

Cutting capacity
R= \approx 80 Kgf/mm²



L	mm		
230	4	3	011020020

1104

heavy-duty cutters for flexible steel cables,
handles with thermoplastic grips



L	mm		
420	12	1	011040004
600	16	1	011040006

1104R

spare blades for item 1104



mm			
420		1	011040014
600		1	011040016



1105

punches made from burnished steel



D	L		
mm	mm		
2	27	1	011050002
3	27	1	011050003
4	27	1	011050004
5	27	1	011050005
6	27	1	011050006
7	27	1	011050007
8	27	1	011050008
9	27	1	011050009
10	27	1	011050010
12	27	1	011050012
14	27	1	011050014
16	27	1	011050016
18	27	1	011050018
20	27	1	011050020
22	32	1	011050022
24	32	1	011050024
26	32	1	011050026
28	32	1	011050028
30	32	1	011050030
32	37	1	011050032
34	37	1	011050034
36	37	1	011050036
38	37	1	011050038
40	37	1	011050040
42	42	1	011050042
44	42	1	011050044
46	42	1	011050046
48	42	1	011050048
50	42	1	011050050

1105T20

shank for punches 1105,
2 to 20 mm



L	mm		
110		1	011050200

1105T30

shank for punches 1105,
3 to 30 mm



L	mm		
155		1	011050201



1105T50

shank for punches 1105
2 to 50 mm



L
mm
155

1 011050202

1105AD-50

shank adaptor for item 1105T50



Ø
mm
57

1 011050210

1105/C10T

assortment of 10 punches,
3 to 20 mm, and 1 accessory



1105/C10T 1 011050250

1105 3 - 4 - 6 - 8 - 10 - 12 - 14 - 16 - 18 - 20 mm

1105T20

135x92x32 mm

1105/C15T

assortment of 15 punches,
3 to 30 mm



1105/C15T 1 011050251

1105 3 - 4 - 6 - 8 - 10 - 12 - 14 - 16 - 18 - 20 - 22 - 24 - 26 - 28 - 30 mm

1105T30

230x190x50 mm

1105/C29T

assortment of 29 punches,
2 to 50 mm



1105/C29T 1 011050252

1105 2 - 3 - 4 - 5 - 6 - 7 - 8 - 9 - 10 - 12 - 14 - 16 - 18 - 20 - 22 - 24 - 26 - 28 - 30 - 32 - 34 - 36 - 38 - 40 - 42 - 44 - 46 - 48 - 50 mm

1105T50
1105AD-50

325x280x55 mm

1112

tin snips straight wide blades

Cutting capacity
R = 60 Kgf/mm²



L	L1	S	A	
mm	mm	mm	mm	
200	50	0,5	26	2 011120020
250	62	0,8	33	2 011120025
300	76	1,0	37	2 011120030
375	76	1,2	44	1 011120037

1114

tin snips straight narrow blades

R = 60 Kgf/mm²

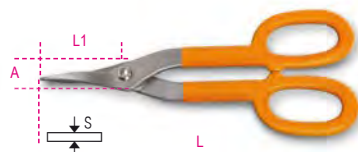

L	L1	S	A	
mm	mm	mm	mm	
250	58	0,5	15	1 011140265
350	76	1	22	1 011140340

1118

safety strap cutting shears

Fe = normal steel
Inox = stainless steel



L	L1	Fe	Inox	A	
mm	mm	S mm	S mm	mm	
310	42	1	0,8		2 011180001

1120A

hand nibbler

Fe = normal steel



L
mm
280

S
mm
1,2

1 011200101

1120ARL - ARG

spare parts for item 1120A



1120ARL 1 011200110
1120ARG 1 011200120

1122

compound leverage shears,
straight blades

Inox = stainless steel



L	L1	Inox	A	
mm	mm	S mm	mm	
250	40	1	24	2 011220020

1123

right cut compound leverage shears,
curved blades

Inox = stainless steel



L	L1	Inox	A	
mm	mm	S mm	mm	
250	40	1	24	2 011230020

1124

left cut compound leverage shears,
curved blades

Inox = stainless steel



L	L1	Inox	A	
mm	mm	S mm	mm	
250	40	1	24	2 011240020

1125

compound leverage shears
for straight and right cuts

Inox = stainless steel

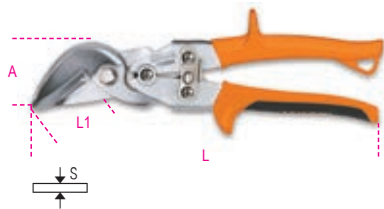

L	L1	Inox	A	
250	35	S mm 1	46	2 011250020

1126

compound leverage shears
for straight and left cuts

Inox = stainless steel

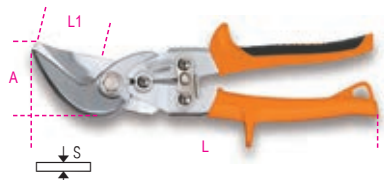

L	L1	Inox	A	
250	35	S mm 1	46	2 011260020

1122 - 1125MOL



1122 MOL	1122 - 1124	1	011220010
1123 MOL	1123	1	011230010
1125 MOL	1125 - 1126	1	011250040

1127

telephone engineer's scissors,
straight blades



L	L1	
150	35	5 011270001

1128BAX

Double-acting electricians' scissors,
with milling profiles in DLC-coated stainless
steel

Double-acting cutting: a special cam on the fulcrum allows the blades to run lengthwise, which results in increased cutting power while closing the blades.

Profile and mill: designed to enlarge holes on plastic, from 13 mm to 25 mm.

DLC coating: DLC (diamond-like carbon) is an innovative carbon-based coating: the high hardness and low coefficient of friction arise from the simultaneous presence of carbon on the surface in the form of graphite, and diamond.

- High blade surface hardness (resistance to abrasion and wear)
- Low coefficient of friction (smoothness and anti-adherence)
- Anti-loose eccentric pin
- Large handles with pipe throttling grooves
- With articulated plastic case



L	L1		
150	50	50	5 011280088

1128BCK

electrician's scissors,
straight stainless steel blades,
with microteeth, cable cutting groove and
crimping pliers for tube terminals

tube terminal crimping: 1+4 mm²
in jointed plastic case



L	L1		
155	55	50	5 011280080

1128BMX

electrician's scissors,
straight stainless steel blades,
with microteeth



L	L1	
147	58,2	5 011280051

1128BMX/F

articulated plastic case
for item 1128BMX



1128BMX/F	1 011280059
-----------	-------------

1128BSX

electrician's scissors
with graduated milling profiles with case



L	L1	
148	58,2	5 011280061

1128FX

electrician's scissors,
straight stainless steel blades,
with microteeth, cable cutting groove and
crimping pliers for tube terminals

- Articulated belt hook case
- Bimaterial handles
- Anti-loose pin



L	L1		
145	52	50	5 011280090

1128FXS

electrician's scissors with graduated milling profiles, straight stainless steel blades, with microteeth, cable cutting groove and crimping pliers for tube terminals

- Articulated belt hook case
- Bimaterial handles
- Anti-loose pin

• Profile and mill: designed to enlarge holes on plastic, from 13 to 21 mm.



L	L1	mm
mm	mm	mm ²
145	52	50

5 011280095

1128BM

electrician's scissors, straight blades



L	L1	mm
mm	mm	
145	50	

5 011280000

1129BM

electrician's scissors, curved blades



L	L1	mm
mm	mm	
145	44	

5 011290000

1130BMX

Multiuse scissors, straight stainless steel blades, with microteeth



L	L1	mm
mm	mm	
185	60	

1 011300002

1131CK

Kevlar® and fibre optics scissors



L	L1	mm
mm	mm	
203	75	

1 011310001

1132

cable cutters for insulated copper and aluminium cables, slip-proof double layer PVC coated handles



UNI 8791

L	mm	mm ²	
~	mm	mm ²	
170	14	50	2 011320107
230	18	95	2 011320113

1132BM

cable cutters for insulated copper and aluminium cables, bi-material handles



UNI 8791

L	mm	mm ²	
~	mm	mm ²	
170	14	50	2 011320137
230	18	95	2 011320143

1133

cable cutter for copper cables, flexible

up to 325 mm²



L	mm	mm ²	
~	mm	mm ²	
600	32	300	1 011330001

1133RL

spare blades for item 1133



L	mm		
1133RL			1 011330011

1134

ratchet cable cutters burnished finish, plastic handles



L	mm	mm ²	
~	mm	mm ²	
260	35	400	1 011340032

1134RL

spare blade for item 1134



L	mm		
1134RL			1 011340132

1134A

ratchet cable cutters burnished finish, plastic handles



L	mm	mm ²	
~	mm	mm ²	
240	45	500	1 011340045

1134A/RL

spare blade for item 1134A



L	mm		
1134A/RL			1 011340145

1136

cable cutter for steel cables

Cutting capacity
Ø 5 mm for cable R ≤ 160 Kg/mm²
Ø 4 mm for mild steel bolts



L	mm		
~	mm		
165			2 011360001

1142BM

wire stripping pliers,
bi-material handles



UNI 7923

L mm	mm ²	mm	Icon	Icon
160	0,5÷6	0-2,8	1	1 011420036

1143

wire stripping pliers



L mm	mm ²	mm	Icon	Icon
165	1÷6	1-3,2	1	1 011430001

1143R

spare blades for item 1143

1143R	1	1 011430011
-------	---	-------------

1144D

cable stripping tool



L mm	mm ²	mm	Icon	Icon
170	4,5÷240	2,5-18	1	1 011440010

1144D/RG

spare hook for item 1144D



1144D/RG	1	1 011440012
----------	---	-------------

1144D/RL

spare blades for item 1144D

1144D/RL	1	1 011440011
----------	---	-------------



1144G

cable stripping tool

with adjustable blade for transverse and longitudinal cuts



L mm	mm ²	mm	Icon	Icon
140	6÷75	2.8-12	1	1 011440004

1144G/RL

spare blade for item 1144G



1144G/RL	1	1 011440005
----------	---	-------------

1144L

cable stripping tool with adjustable blade
depth, for transverse and longitudinal stripping

with smooth and hook-shaped retractable blade



L mm	mm ²	mm	Icon	Icon
145	6-150	4-28	1	1 011440050

1148A

wire stripping pliers, self-adjusting,
with cutting device

cutting capacity
≠10 mm² (8 AWG) flexible wires
≠1,5 mm² (16 AWG) sturdy wires



L mm	mm ²	mm	Icon	Icon
190	0,02÷10	0-4	1	1 011480100

1148A/R

spare blades for item 1148A



1148A/R	1	1 011480102
---------	---	-------------

1148B

wire stripping pliers, self-adjusting,
with cutting device

cutting capacity
≠10 mm² (8 AWG) flexible wires
≠1,5 mm² (16 AWG) sturdy wires



L mm	mm ²	mm	Icon	Icon
190	4÷16	2-5	1	1 011480200

1148B/R

spare blades for item 1148B



1148B/R	1	1 011480202
---------	---	-------------

1148P

wire stripping pliers, self-adjusting, with cutting
device



L mm	mm ²	mm	Icon	Icon
165	0.2-6	0-3.5	1	1 011480300

1149F

front wire stripping pliers with cutting blade,
self-adjusting



L mm	mm ²	mm	Icon	Icon
175	0,2 ÷ 6		1	1 011490010



1150

combination pliers
bright chrome-plated,
slip-proof double layer PVC coated handles



ISO 5746

L mm	L1 mm	mm		
160	42	1,6	5	011500046
180	46	1,8	5	011500048
200	50	2,0	5	011500050
220	50	2,0	2	011500052

1150G

heavy duty combination pliers,
slip-proof double layer PVC coated handles,
industrial finish



ISO 5746

L mm	L1 mm	mm		
160	42	1,6	5	011500066
180	46	1,8	5	011500068
200	50	2,0	5	011500070
220	50	2,0	2	011500072

1150HPC

heavy duty combination pliers with integrated
cutting edges and decentralized pin
matt chrome plated finish
bi-material handles
open joint

integrated cutting edge
steel: M2
thickness: 0.20 mm
angle: 62°
hardness: 63+65 HRC



ISO 5746

L mm	L1 mm	mm		
180	42	1,8	2	011500618

1150BM

combination pliers bright chrome-plated,
bi-material handles



ISO 5746

L mm	L1 mm	mm		
160	42	1,6	3	011500146
180	46	1,8	3	011500148
200	50	2,0	3	011500150
220	50	2,0	2	011500152

1150GBM

heavy duty combination pliers,
bi-material handles,
industrial finish



ISO 5746

L mm	L1 mm	mm		
160	42	1,6	3	011500266
180	39	1,8	3	011500268
200	50	2,0	3	011500270
220	50	2,0	2	011500272

1153

adjustable pliers,
two positions, PVC-coated handles



UNI ISO 9343

L mm	L1 mm			
200	34		2	011530120

1162

extra-long flat knurled nose pliers,
chrome-plated,
slip-proof double layer PVC coated handles



ISO 5745

L mm	L1 mm	mm		
160	58	1,6	5	011620006
200	86	1,6	5	011620010

1162G

extra-long flat knurled nose pliers,
slip-proof double layer PVC coated handles,
industrial finish



ISO 5745

L mm	L1 mm	mm		
160	58	1,6	5	011620066
200	86	1,6	5	011620070

1162BM

extra-long flat knurled nose pliers,
chrome-plated,
bi-material handles



ISO 5745

L mm	L1 mm	mm		
160	58	1,6	3	011620036
200	86	1,6	3	011620040

1162GBM

extra-long flat knurled nose pliers,
bi-material handles,
industrial finish



ISO 5745

L mm	L1 mm	mm		
160	58	1,6	3	011620266
200	86	1,6	3	011620270

1164

extra long bent flat knurled nose pliers,
slip-proof double layer PVC coated handles



ISO 5745

L mm	L1 mm	mm		
160	54	1,6	5	011640006
200	76	1,6	5	011640010



1164BM

extra long bent flat knurled nose pliers,
bi-material handles



ISO 5745

L mm	L1 mm	mm	
160	54	1,6	3 011640036
200	76	1,6	3 011640040

1166

extra-long needle knurled nose pliers,
chrome-plated,
slip-proof double layer PVC coated handles



ISO 5745

L mm	L1 mm	mm	
160	56	1,6	5 011660006
200	76	1,6	5 011660010

1166G

extra-long needle knurled nose pliers,
slip-proof double layer PVC coated handles,
industrial finish



ISO 5745

L mm	L1 mm	mm	
160	56	1,6	5 011660066
200	76	1,6	5 011660070

1166BM

extra-long needle knurled nose pliers,
chrome-plated,
bi-material handles



ISO 5745

L mm	L1 mm	mm	
160	56	1,6	3 011660036
200	76	1,6	3 011660040

1166GBM

extra-long needle knurled nose pliers,
bi-material handles,
industrial finish



ISO 5745

L mm	L1 mm	mm	
160	56	1,6	3 011660266
200	76	1,6	3 011660270

1168

extra-long bent needle knurled nose pliers,
chrome-plated,
slip-proof double layer PVC coated handles



ISO 5745

L mm	L1 mm	mm	
160	54	1,6	5 011680006
200	76	1,6	5 011680010

1168G

extra-long bent needle knurled nose pliers,
slip-proof double layer PVC coated handles,
industrial finish



ISO 5745

L mm	L1 mm	mm	
160	54	1,6	5 011680066
200	76	1,6	5 011680070

1168BM

extra-long bent needle knurled nose pliers,
chrome-plated,
bi-material handles



ISO 5745

L mm	L1 mm	mm	
160	54	1,6	3 011680036
200	70	1,6	3 011680040

1168GBM

extra-long bent needle knurled nose pliers,
bi-material handles,
industrial finish



ISO 5745

L mm	L1 mm	mm	
160	54	1,6	3 011680266
200	70	1,6	3 011680270

1169/D3

set of 1 combination pliers, 1 long needle nose
pliers and 1 diagonal cutting nippers



1169/D3

1082 160mm
1150 180mm
1166 160mm

1 011690053

1169G/D3

set of 1 combination pliers,
1 long needle nose pliers
and 1 diagonal cutting nippers, slip-proof
double layer PVC, industrial finish



1169G/D3

1082G 160mm
1150G 180mm
1166G 160mm

1 011690073

1169BM/D3

set of 1 combination pliers, 1 long needle nose pliers and 1 diagonal cutting nippers



1169BM/D3	1	011690133
1082BM 160mm		
1150BM 180mm		
1166BM 160mm		

1169GBM/D3

set of 1 combination pliers, 1 long needle nose pliers and 1 diagonal cutting nippers, bi-material handles, industrial finish



1169GBM/D3	1	011690273
1082GBM 160mm		
1150GBM 180mm		
1166GBM 160mm		

1171BM

smooth, flat short nose pliers
bi-material handles



ISO 9655

L	L1	A	B		
~ 130	mm 18	mm 12	mm 8	2	011710101

1172BM

smooth, flat long nose pliers
bi-material handles

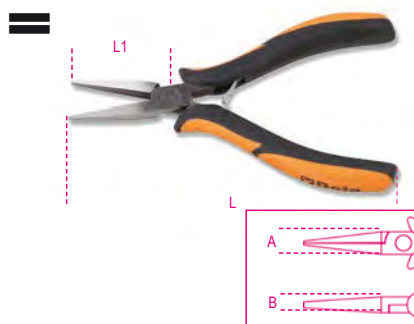

ISO 9655

L	L1	A	B		
~ 140	mm 40	mm 12	mm 8	2	011720101

1172BM/P

smooth, flat bent long nose pliers
bi-material handles



L	L1	A	B		
~ 140	mm 38	mm 12	mm 13	2	011720102

1173BM

round short nose pliers
bi-material handles

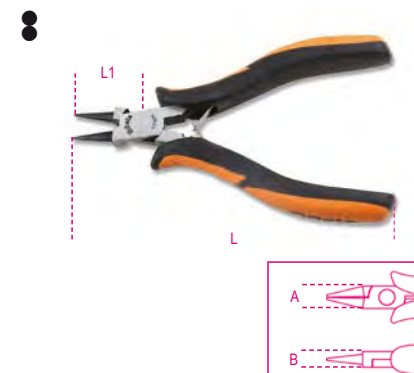

ISO 9655

L	L1	A	B		
~ 125	mm 22	mm 12	mm 8	2	011730101

1175BM

smooth half-round short nose pliers
bi-material handles



ISO 9655

L	L1	A	B		
~ 140	mm 29	mm 12	mm 8	2	011750101

1177BM

smooth half-round long nose pliers
bi-material handles



ISO 9655

L	L1	A	B		
~ 140	mm 38	mm 12	mm 8	2	011770101

1177BM/Z

half-round long knurled nose pliers
bi-material handles

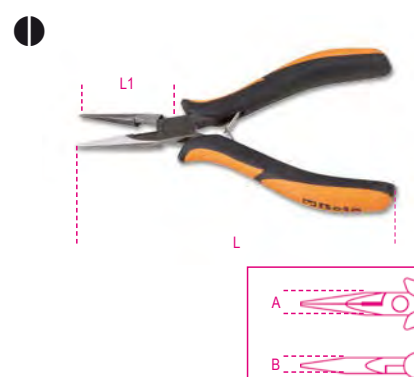

ISO 9655

L	L1	A	B		
~ 140	mm 39	mm 12	mm 8	2	011770113

1178BM

smooth half-round long needle nose pliers
bi-material handles

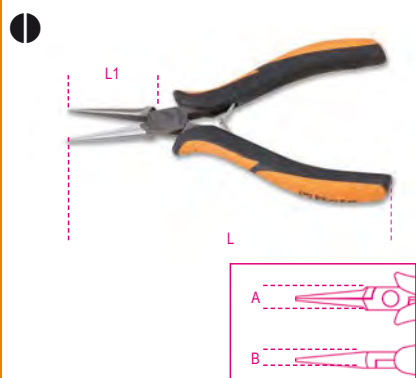

ISO 9655

L	L1	A	B	
mm	mm	mm	mm	
140	37	12	8	2 011780101

1178BM/P

smooth half-round long bent
needle nose pliers
bi-material handles



L	L1	A	B	
mm	mm	mm	mm	
140	36,5	12	12	2 011780102

Beta

Copper cutting nippers.
For heavier duty jobs see item 1081

1182BM

diagonal semi-flush cutting nippers,
slim tips
bi-material handles



ISO 9654

L	L1	A	Cu	
mm	mm	mm	mm	
120	11	10	1	2 011820101

1183BM

diagonal semi-flush cutting nippers,
rounded tips
bi-material handles



ISO 9654

L	L1	A	Cu	
mm	mm	mm	mm	
120	11	10	1	2 011830101

1184BM

diagonal flush cutting nippers,
rounded tips
bi-material handles



ISO 9654

L	L1	A	Cu	
mm	mm	mm	mm	
120	11	10	1	2 011840101
130	13	12,5	1,25	2 011840102

1185BM

diagonal flush cutting nippers,
slim tips
bi-material handles



ISO 9654

L	L1	A	Cu	
mm	mm	mm	mm	
120	11	10	1	2 011850101
130	13	12,5	1,25	2 011850102

1186BM

diagonal flush cutting nippers,
slim tapering tips
bi-material handles



ISO 9654

L	L1	A	Cu	
mm	mm	mm	mm	
120	11	10	1	2 011860101
130	13	12,5	1,25	2 011860102

1188BM

diagonal axial cutting nippers
bi-material handles



ISO 9654

L mm	L1 mm	A mm	Cu mm		
125	12	12	1,25	2	011880101
130	17	15	2	2	011880102

1190BM

end semi-flush cutting nippers
bi-material handles



ISO 9654

L mm	L1 mm	A mm	Cu mm		
120	12	12	1,25	2	011900113

1191BM

end flush oblique cutting nippers
bi-material handles



ISO 9654

L mm	L1 mm	A mm	Cu mm		
130	8	12	0,8	2	011910101

1191BM/L

end flush long oblique cutting nippers
bi-material handles



ISO 9654

L mm	L1 mm	A mm	Cu mm		
130	18	12	1	2	011910110

1191R/5-M

spare spring kit for pliers and nippers for
electronics, 5 pairs (items: 1171...1191)

1191R/5-M	1	011910995
-----------	---	-----------

1200MS

magnetizer/demagnetizer

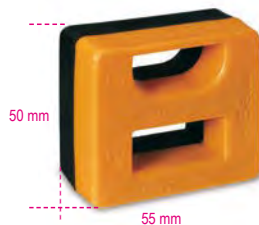

1200MS	5	012000000
--------	---	-----------



1201E

screwdriver for slotted head screws



SxAxL mm	L1 mm	Ø mm		
0,4x2,5x50	146	2,5	5	012011003
0,4x2,5x75	166	2,5	5	012011006
0,5x3x75	171	3,0	5	012011009
0,5x3x100	196	3,0	5	012011012
0,6x3,5x75	171	3,5	5	012011018
0,6x3,5x100	196	3,5	5	012011021
0,8x4x100	196	4,0	5	012011030
0,8x4x125	221	4,0	5	012011033
0,8x4x150	246	4,0	5	012011036
1,0x5,5x100	209	5,0	5	012011039
1,0x5,5x125	234	5,0	5	012011040
1,0x5,5x150	259	5,0	5	012011042
1,2x6,5x100	220	6,0	5	012011048
1,2x6,5x125	234	6,0	5	012011050
1,2x6,5x150	270	6,0	5	012011051
1,2x8x150	282	8,0	3	012011057
1,2x8x200	332	8,0	3	012011060
1,6x10x200	332	9,5	3	012011066



1201E/S6	1	012011206
0,5x3x75-0,6x3,5x100		
0,8x4x100-1,0x5,5x100		
1,2x8x150-1,6x10x200 mm		

1201EN

screwdriver for slotted head screws,
extra-short series



SxAxL mm	L1 mm	Ø mm		
0,8x4x30	86,5	4	3	012011103
1,2x6,5x30	86,5	6 51	3	012011106

1201E/DZ

screwdriver for Dzus® head screws



L mm	L1 mm		
53	173	2	012011501

1202E

screwdriver for cross head Phillips® screws



PHxDxL mm	L1 mm		
0x3x60	156	5	012021003
0x3x100	200	5	012021006
1x4,5x80	189	5	012021009
1x4,5x120	229	5	012021012
2x6x100	220	5	012021018
2x6x150	270	5	012021021
3x8x150	282	3	012021024
4x9,5x200	332	3	012021027



1202E/S4	1	012021204
PH0x3x60-PH1x4,5x120 PH2x6x150-PH3x8x150 mm		

1202EN

screwdriver for cross head Phillips® screws, extra-short series



PHxDxL mm	L1 mm		
1x4,5x30	86,5	3	012021103
2x6x30	86,5	3	012021106

1202EL

screwdriver for cross head Phillips® screws, long series

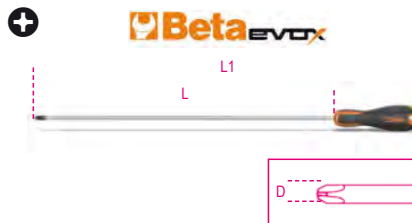

PHxDxL mm	L1 mm		
0x3x300	400	3	012021303
1x4,5x300	400	3	012021305
1x4,5x400	508	3	012021306
2x6x400	519	3	012021309

1203E/D

set of screwdrivers

Beta EVOLX



1203E/D5	1	012031001
-----------------	---	-----------

1201E	0,6x3,5x100-1,0x5,5x150 1,2x6,5x150 mm
1202E	PH1x4,5x80-PH2x6x100 mm

1203E/D5PZ	1	012031003
-------------------	---	-----------

1201E	0,5x3x75-0,8x4x125 1,0x5,5x150 mm
1209E/PZ	PZ1x4,5x80-PZ2x6x100 mm

1203E/D6	1	012031006
-----------------	---	-----------

1202E	PH1x4,5x80-PH2x6x100 mm
1204E	0,4x2,5x60-0,5x3x100 0,8x4x100-1,0x5x125 mm

1203E/D7	1	012031007
-----------------	---	-----------

1201E	0,5x3x75-0,8x4x100 1,0x5,5x100-1,2x6,5x150 mm
1202E	PH0x3x60-PH1x4,5x80 PH2x6x100 mm

1203E/D8	1	012031008
-----------------	---	-----------

1201E	0,5x3x75-0,8x4x125 1,0x5,5x150-1,2x6,5x150 mm
1202E	PH0x3x60-PH1x4,5x80 PH2x6x100-PH3x8x150 mm

1203E/D10	1	012031010
------------------	---	-----------

1201E	0,4x2,5x50-0,5x3x75 0,8x4x100-1,0x5,5x100 1,2x6,5x150-1,2x8x150 mm
1202E	PH0x3x60-PH1x4,5x80 PH2x6x100-PH3x8x150 mm

1203E/D10N	1	012031019
-------------------	---	-----------

1201E	0,4x2,5x50-0,5x3x75-0,8x4x100- 1,0x5,5x150-1,2x6,5x150 mm
1201EN	0,8x4x30 mm
1202E	PH0x3x60-PH1x4,5x80- PH2x6x100 mm
1202EN	PH1x4,5x30 mm



1203E/S

Beta EVOLX



1203E/S8	1	012031009
-----------------	---	-----------

1201E	2,5x50-3x75-4x100-5,5x125- 6,5x150 mm
1202E	PH0x3x60-PH1x4,5x80- PH2x6x100 mm

1203E/S10	1	012031021
------------------	---	-----------

1201E	0,4x2,5x50-0,5x3x75 0,8x4x125-1,0x5,5x150 1,2x6,5x150-1,2x8x150 mm
1202E	PH0x3x60-PH1x4,5x80 PH2x6x100-PH3x8x150 mm

1204E

screwdriver for headless slotted screws



SxDxL mm	L1 mm		
0,4x2,5x60	156	5	012041003
0,6x3x75	175	5	012041006
0,5x3x100	196	5	012041009
0,8x4x100	196	5	012041012
0,8x4x125	233	5	012041015
1x5x125	234	5	012041018
1x5x150	258	5	012041021
1,2x6,5x150	270	5	012041024



1204E/S5	1	012041205
-----------------	---	-----------

0,4x2,5x60-0,5x3x100 0,8x4x100-1x5x125 1,2x6,5x150 mm

1204EL

screwdriver for headless slotted screws, long series

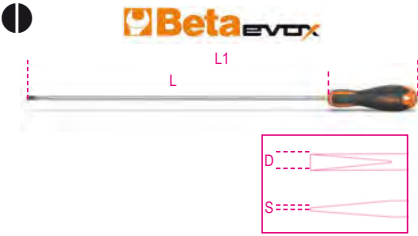

SxDxL mm	L1 mm		
0,5x2,5x200	300	3	012041303
0,5x3x300	400	3	012041306
0,8x4x400	508	3	012041309
1x5x400	508	3	012041315
1,2x6,5x400	519	3	012041318

1205E/ES

hexagon drivers with handles



mm	L mm	L1 mm		
1,5	100	200	3	012051315
2	100	200	3	012051320
2,5	100	200	3	012051325
3	100	200	3	012051330
4	100	208	3	012051340
5	100	219	3	012051350
6	125	244	3	012051360
8	150	277	2	012051380

Beta EVOX



1205E/ES-S8
1,5-2-2,5-3-4-5-6-8 mm

1206E/BP

ball head hexagon drivers with handles



mm	L mm	L1 mm	Ø mm		
2	100	198	2,5	3	012061320
2,5	100	198	3,0	3	012061325
3	100	198	3,5	3	012061330
4	100	209	5,0	3	012061340
5	100	220	6,0	3	012061350
6	125	245	7,0	3	012061360
8	150	287	9,5	2	012061380



Beta EVOX



1206E/BP-S7
2-2,5-3-4-5-6-8 mm

1207E/TX

screwdrivers for Torx® head screws, with handles



Beta EVOX



	L mm	L1 mm	Ø mm		
T5	50	150	3	5	012071005
T6	60	156	4	5	012071006
T7	60	156	4	5	012071007
T8	60	156	4	5	012071008
T9	60	156	4	5	012071009
T10	80	189	5	5	012071010
T15	80	189	5	5	012071015
T20	100	209	5	5	012071020
T25	100	209	5	5	012071025
T27	100	220	6	5	012071027
T30	100	220	6	5	012071030
T40	130	262	7	2	012071040
T45	130	262	8	2	012071045

Beta EVOX



1207E/TX-D7
T6-T8-T10-T15
T20-T25-T30
1207E/TX-D13
T5-T6-T7-T8-T9-T10-T15
T20-T25-T27-T30-T40-T45

1208E/RTX

screwdrivers for Tamper Resistant Torx® head screws, with handles



Beta EVOX

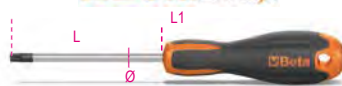

	L mm	L1 mm	Ø mm		
T9	60	156	4	5	012081009
T10	80	189	5	5	012081010
T15	80	189	5	5	012081015
T20	100	209	5	5	012081020
T25	100	209	5	5	012081025
T27	100	220	6	5	012081027
T30	100	220	6	5	012081030
T40	130	262	7	2	012081040



Beta EVOX



1208E/RTX-D7
T9-T10-T15-T20
T25-T27-T30

1209E/PZ

screwdriver for cross head Pozidriv®-Supadriv® screws



Beta EVOX

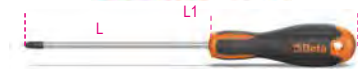

PZ	L mm	L1 mm		
0	60	156	5	012091000
1	80	189	5	012091003
2	100	220	5	012091006
3	150	282	3	012091009
4	200	327	3	012091012



Beta EVOX



1209E/PZ-S4
PZ0-PZ1-PZ2-PZ3

1209EN/PZ

screwdriver for cross head Pozidriv®-Supadriv® screws, extra-short series



Beta EVOX



PZ	L mm	L1 mm		
1	30	87	3	012091103
2	30	87	3	012091106



1229LP

micro-screwdrivers
for headless slotted screws

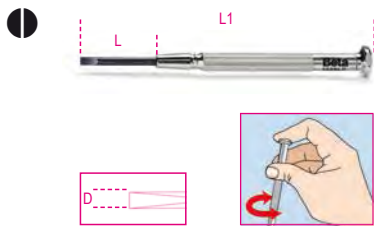

D mm	L mm	L1 mm	
1,0	17	75	5 012290210
1,2	21	85	5 012290212
1,4	21	89	5 012290214
1,8	23	94	5 012290218
2,0	23	98	5 012290220
2,4	26	103	5 012290224
3,0	28	108	5 012290230



1229LP/A6
1,2-1,4-1,8-2-2,4-3 mm
1 012290300

1229PH

micro-screwdrivers for cross head
Phillips® screws

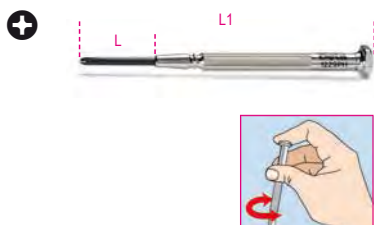

PH	L mm	L1 mm	
0	26	102	5 012290250
1	29	107	5 012290251

1229LPH/A6

set of 6 micro-screwdrivers
items 1229LP-1229PH



1229LPH/A6
1 012290310
1229LP 1,4-2,0-2,4-3 mm
1229PH PH0-PH1

1236B

offset screwdrivers
for slotted head screws



UNI 7079 DIN 5200

SxA mm	L mm	
0,8x4	100	5 012360201
1x5,5	125	5 012360202
1,2x8	150	5 012360204

1238B

offset screwdrivers
for cross head Phillips® screws



UNI 7083 DIN 5208

PH	L mm	
1-2	125	5 012380201
3-4	200	5 012380203

1241

screwdrivers with steel head for slotted head
screws



ISO 2380

SxAxL mm	L1 mm	
1x5,5x100	202	5 012410039
1,2x6,5x125	240	5 012410050
1,2x8x150	268	3 012410057
1,6x10x200	325	2 012410066

1242

screwdrivers with steel head for cross head
Phillips® screws



UNI/ISO 8764

PHxDxL mm	L1 mm	
1x4,5x100	202	5 012420209
2x6x100	215	5 012420218
3x8x150	268	3 012420221
4x11x200	325	2 012420224

1243/D7

Set of 7 screwdrivers with steel heads



1243/D7		1 012430017
1241	1x5,5x100-1,2x6,5x125 1,2x8x150-1,6x10x200 mm	
1242	PH1x4,5x100-PH2x6x100 PH3x8x150 mm	

1250

screwholding screwdrivers
for slotted head screws

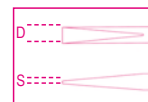

SxDxL mm	L1 mm	
0,5x3x125	190	5 012500030
0,6x4x125	225	5 012500040
0,7x5x150	255	5 012500050

1251

screwholding screwdrivers
for cross head Phillips® screws



PHxDxL mm	L1 mm	
0x4x125	225	5 012510000
1x5x150	255	5 012510010
2x6x175	280	5 012510020

1252/S5



1252/S5		1 012520001
1250	0,5x3x125-0,6x4x125 0,7x5x150 mm	
1251	PH1x5x150-PH2x6x175 mm	

1253
mains testing screwdriver 150/250V

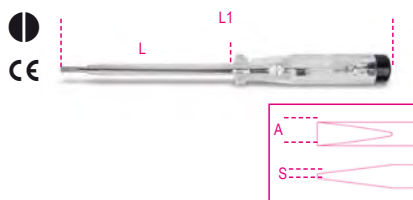

SxAxL mm	L1 mm	5	012530001
0,5x3,5x100	190	5	012530001

1253A
mains testing screwdriver 125/250V,
double insulation



SxAxL mm	L1 mm	5	012530010
0,5x3x15	150	5	012530010

1254
circuit testing screwdriver 6-24V

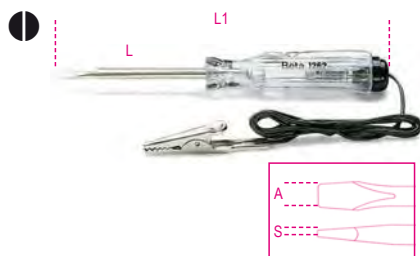

SxAxL mm	L1 mm	5	012540001
0,5x3x44	123	5	012540001

1256/C36-2
microscrewdriver with 36 interchangeable
4-mm bits and magnetic extension



1256/C36-2	1	012560100
1256/C36-2	1	012560100

- 1256TX T3 - T4 - T5 - T6 - T7
T8 - T9 - T10 - T15
- 1256RTX T6 - T7 - T8 - T9 - T10
- 1256LP 0,8 - 1,2 - 1,5 - 1,8 - 2 - 2,5
3 - 3,5 - 4 mm
- 1256PE 0,7 - 0,9 - 1,3 - 1,5 - 2 mm
- 1256PH PH000 - PH00 - PH0 - PH1
- 1256PZ PZ000 - PZ00 - PZ0 - PZ1

1256/20
 1256/30
130x60x35 mm - 200 g

1256LP
4-mm bits
for slotted head screws

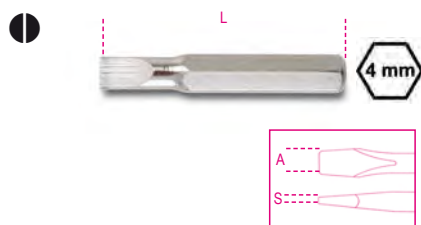

SxA mm	L mm	5	012560001
0,25x0,8	27	5	012560001
0,25x1,2	27	5	012560002
0,3x1,5	27	5	012560003
0,35x1,8	27	5	012560004
0,4x2,0	27	5	012560005
0,4x2,5	27	5	012560006
0,5x3,0	27	5	012560007
0,6x3,5	27	5	012560008
0,8x4,0	27	5	012560009

1256PH
4-mm bits
for cross head Phillips® screws



PH	L mm	5	012560011
000	27	5	012560011
00	27	5	012560012
0	27	5	012560013
1	27	5	012560014

1256PZ
4-mm bits
for slotted head Pozidriv® - Supradriv® screws



PZ	L mm	5	012560061
000	27	5	012560061
00	27	5	012560062
0	27	5	012560063
1	27	5	012560064

1256PE
4-mm bits
for hexagon head screws



mm	L mm	5	012560021
0,7	27	5	012560021
0,9	27	5	012560022
1,3	27	5	012560023
1,5	27	5	012560024
2,0	27	5	012560025

1256TX
4-mm bits
for Torx® head screws



T	L mm	5	012560041
T3	27	5	012560041
T4	27	5	012560042
T5	27	5	012560043
T6	27	5	012560044
T7	27	5	012560045
T8	27	5	012560046
T9	27	5	012560047
T10	27	5	012560048
T15	27	5	012560049

1256RTX
4-mm bits
for Tamper Resistant Torx® head screws



T	L mm	5	012560051
T6	27	5	012560051
T7	27	5	012560052
T8	27	5	012560053
T9	27	5	012560054
T10	27	5	012560055

1256/20
hexagon drive extension, 4 mm



1256/20	5	012560092
1256/20	5	012560092

1256/30
4-mm bit holder with handle



L mm	2	012560097
110	2	012560097

1257LP
micro-screwdrivers
for slotted head screws

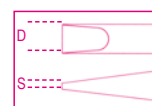

SxD mm	L mm	5	012570012
0,25x1,2	60	5	012570012
0,23x1,5	60	5	012570015
0,3x1,8	60	5	012570018
0,4x2	60	5	012570020
0,4x2,5	60	5	012570024
0,5x3	60	5	012570030
0,6x3,5	60	5	012570035
0,8x4	60	5	012570040



1257LP/S8
0,2x1,2-0,25x1,5
0,3x1,8-0,4x2-0,4x2,5
0,5x3-0,6x3,5-0,8x4 mm

1 012570200

1257PH

micro-screwdrivers
for cross-head Phillips® screws



PH	L mm	
00	60	5 012570060
0	60	5 012570063
1	60	5 012570066

1257LPH/S8



1257LPH/S8
1257PH PH00-PH0-PH1
1257LP 0,4x2-0,4x2,5-0,5x3
0,6x3,5-0,8x4 mm

1 012570210

1257ES

micro-screwdrivers hexagon male ends

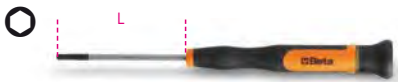

mm	L mm	
0,9	60	5 012570045
1,3	60	5 012570046
1,5	60	5 012570047
2	60	5 012570048
2,5	60	5 012570049
3	60	5 012570050

1257ESB/S8



1257ESB/S8
1257ES 0,9-1,3-1,5-2-2,5-3 mm
1257BE 4-5 mm

1 012570230

1257TX

micro-screwdrivers for Torx®
head screws



	L mm	
T5	60	5 012570075
T6	60	5 012570076
T7	60	5 012570077
T8	60	5 012570078
T9	60	5 012570079
T10	60	5 012570080
T15	60	5 012570081
T20	60	5 012570082



1257TX/S8
T5-T6-T7-T8
T9-T10-T15-T20

1 012570220

1257BE

micro-screwdrivers hexagon socket wrenches



mm	L mm	
3,2	60	5 012570085
4	60	5 012570086
5	60	5 012570087
5,5	60	5 012570088

1260

screwdrivers for slotted head screws



ISO 2380

SxAxL mm	L1 mm	Ø mm	
0,4x2,5x50	150	2,5	5 012600003
0,4x2,5x75	175	2,5	5 012600006
0,5x3x75	175	3,0	5 012600009
0,5x3x100	200	3,0	5 012600012
0,6x3,5x75	175	3,5	5 012600018
0,6x3,5x100	200	3,5	5 012600021
0,8x4x100	208	4,0	5 012600030
0,8x4x125	233	4,0	5 012600033
0,8x4x150	258	4,0	5 012600036
1x5,5x100	208	5,0	5 012600039
1x5,5x125	233	5,0	5 012600040
1x5,5x150	258	5,0	5 012600042
1,2x6,5x100	219	6,0	5 012600048
1,2x6,5x125	244	6,0	5 012600050
1,2x6,5x150	269	6,0	5 012600051
1,2x8x150	277	8,0	3 012600057
1,2x8x200	327	8,0	3 012600060
1,6x10x200	327	9,5	3 012600066
2x12x250	377	10	3 012600069
2x14x250	377	10	2 012600073



1260/S6
0,4x2,5x75-0,5x3x75-0,8x4x125
1x5,5x150-1,2x6,5x150-1,2x8x200 mm

1 012600306

1260N

screwdrivers for slotted head screws,
extra-short series



ISO 2380

SxAxL mm	L1 mm	Ø mm	
0,8x4x30	87	4	5 012600103
1,2x6,5x30	87	6	5 012600106

Beta
Quality Tools

1260E

screwdrivers for slotted head screws with hexagon bolsters



ISO 2380

SxAxL mm	L1 mm	Ø mm		
1,2x6,5x150	269	6,0	3	012600156
1,2x8x175	301	8,0	3	012600157
1,6x10x200	327	9,5	2	012600159
2x12x250	377	9,5	2	012600162

1262

screwdrivers for cross head Phillips® screws



UNI/ISO 8764

PHxDxL mm	L1 mm		
0x3x60	160	5	012620003
0x3x100	200	5	012620006
1x4,5x80	188	5	012620009
1x4,5x120	228	5	012620012
2x6x100	219	5	012620018
2x6x150	269	5	012620021
3x8x150	277	3	012620024
4x10x200	327	3	012620027



1262/S4	1	012620304
PH0x3x60-PH1x4,5x80 PH2x6x100-PH3x8x150 mm		

1262N

screwdrivers for cross head Phillips® screws, extra-short series



UNI/ISO 8764

PHxDxL mm	L1 mm		
1x4,5x30	87	5	012620103
2x6x30	87	5	012620106

1262E

screwdrivers for cross head Phillips® screws with hexagon bolsters



UNI/ISO 8764

PHxDxL mm	L1 mm		
2x6x150	269	3	012620153
3x8x175	302	3	012620156
4x10x200	327	2	012620159

1262L

screwdrivers for cross head Phillips® screws, long series



UNI/ISO 8764-1

PHxDxL mm	L1 mm		
0x3x300	400	3	012620203
1x4,5x300	400	3	012620205
1x4,5x400	508	3	012620206
2x6x400	519	3	012620209

1263/D...

set of screwdrivers



1263/D6	1	012630006
1260	0,5x3x75-0,8x4x100 1x5,5x125-1,2x6,5x150 mm	
1262	PH1x4,5x80-PH2x6x100 mm	

1263/D7	1	012630017
1262	PH0x3x60 PH1x4,5x80 PH2x6x100 mm	
1264	0,5x2,5x60-0,6x3x100 0,8x4x125-1x5x125 mm	

1263/D7PZ	1	012630007
1260	0,5x3x75-0,8x4x100 1x5,5x150-1,2x6,5x150 mm	
1269PZ	PZ0 - PZ1 - PZ2	

1263/D8	1	012630008
1260	0,4x2,5x50-0,5x3x75 0,8x4x100-1x5,5x150 1,2x6,5x150 mm	
1262	PH0x3x60-PH1x4,5x80 PH2x6x100 mm	

1263/D10	1	012630010
1260	0,5x3x75-0,6x3,5x100 0,8x4x125-1x5,5x150 1,2x6,5x150 mm	
1260N	0,8x4x30	
1262	PH0x3x60-PH1x4,5x80 PH2x6x100 mm	
1262N	PH1x4,5x30	

1263/S12

set of 12 screwdrivers



1263/S12	1	012630112
1260	0,4x2,5x50-0,5x3x75 0,6x3,5x100-0,8x4x125 1x5,5x125-1,2x6,5x150 1,2x8x200-1,6x10x200 mm	
1262	PH0x3x60-PH1x4,5x80 PH2x6x100-PH3x8x150 mm	

1264

screwdrivers for headless slotted screws



SxDxL mm	L1 mm		
0,5x2,5x60	160	5	012640003
0,6x3x75	175	5	012640006
0,6x3x100	200	5	012640009
0,8x4x100	208	5	012640012
0,8x4x125	233	5	012640015
1x5x125	233	5	012640018
1x5x150	258	5	012640021
1,2x6,5x150	269	5	012640024



1264/S5	1	012640305
0,5x2,5x60-0,6x3x75 0,8x4x100-1x5x125-1,2x6,5x150 mm		

1264L

screwdrivers for headless slotted screws, long series



SxDxL mm	L1 mm		
0,5x2,5x200	300	3	012640203
0,6x3x300	400	3	012640206
0,8x4x400	508	3	012640209
1x5x400	508	3	012640215
1,2x6,5x400	519	3	012640218

1265ES

hexagon drivers with handles



mm	L mm	L1 mm		
1,5	100	200	3	012650015
2	100	200	3	012650020
2,5	100	200	3	012650025
3	100	200	3	012650030
4	100	208	3	012650040
5	100	219	3	012650050
6	125	244	3	012650060
8	150	277	2	012650080



1265ES/S8 1 012650308

1266BP

ball head hexagon drivers with handles



mm	L mm	L1 mm		
2	100	200	3	012660020
2,5	100	200	3	012660025
3	125	225	3	012660030
4	125	233	3	012660040
5	120	239	3	012660050
6	140	259	3	012660060
8	160	287	2	012660080
10	160	287	2	012660100



1266BP/S8 1 012660308

1267TX

drivers for Torx® head screws, with handles



	L mm	L1 mm	Ø mm		
T5	50	150	3	5	012670005
T6	50	150	3	5	012670006
T7	50	150	3	5	012670007
T8	60	160	3	5	012670008
T9	60	167	4	5	012670009
T10	80	188	4	5	012670010
T15	80	188	4	5	012670015
T20	100	208	4,5	5	012670020
T25	100	208	5	5	012670025
T27	115	234	6	5	012670027
T30	115	234	6	5	012670030
T40	130	257	7	2	012670040
T45	130	257	8	2	012670045



1267TX/D7 1 012670307



1267TX/S13 1 012670312

1268RTX

screwdrivers for Tamper Resistant Torx® head screws, with handles



	L mm	L1 mm	Ø mm		
T9	60	167	4,0	3	012680009
T10	80	188	4,0	3	012680010
T15	80	188	4,0	3	012680015
T20	100	208	4,5	3	012680020
T25	100	208	5,0	3	012680025
T27	115	234	6,0	3	012680027
T30	115	234	6,0	3	012680030
T40	130	257	7,0	2	012680040



1268RTX/S8 1 012680307

1269PZ

screwdrivers for cross head Pozidriv®-Supadriv® screws



UNI/ISO 8764

PZ	L mm	L1 mm		
0	60	160	5	012690000
1	80	188	5	012690001
2	100	219	5	012690002
3	150	277	3	012690003
4	200	327	3	012690004



1269PZ/S4 1 012690304

1269N/PZ

screwdrivers for cross head Pozidriv®-Supadriv® screws, extra-short series



UNI/ISO 8764

PZ	L mm	L1 mm		
1	30	87	5	012690011
2	30	87	5	012690012

1281BG

interchangeable blade screwdriver handle



L mm	mm		
118	10	5	012810280

1281PM

quick-fit magnetic bit holder



L mm			
165		5	012810292

1281PB

socket holder with 1/4" male drive



L mm			
175		5	012810293

1281LP

reversible screwdrivers for slotted head screws

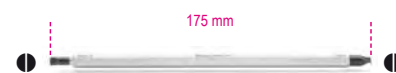

1281LP/1	0,8x4-1,2x6,5 mm	5	012810302
1281LP/2	1x5,5-1,2x6,5 mm	5	012810304

1281PH

reversible screwdrivers for cross head Phillips® screws



PH 1-2	5	012810310
2-3	5	012810312

1281LPH

reversible screwdrivers for slotted and Phillips® head screws



1281LPH/1	PH0-0,8x4 mm	5	012810321
1281LPH/2	PH1-1x5,5 mm	5	012810322
1281LPH/3	PH2-1,2x6,5 mm	5	012810323

1281PZ

reversible screwdrivers for cross head Pozidriv®-Supadriv® screws



PZ 1-2	5	012810330
2-3	5	012810332

1281PE

reversible ball head hexagon screwdriver blades



mm			
2,5		5	012810342
3		5	012810343
4		5	012810344
5		5	012810345
6		5	012810346

1281TX

reversible screwdrivers for Torx® head screws



1281TX/1	T6-T8	5	012810349
1281TX/2	T7-T9	5	012810350
1281TX/3	T10-T15	5	012810351
1281TX/4	T20-T25	5	012810352
1281TX/5	T30-T40	5	012810353

1281RTX

reversible screwdrivers for Tamper Resistant Torx® head screws



1281RTX/3	T10-T15	5	012810361
1281RTX/4	T20-T25	5	012810362
1281RTX/5	T30-T40	5	012810363

1281BG/A9

assortment of 9 reversible screwdrivers and 1 accessory in case



1281BG/A9		1	012810520
-----------	--	---	-----------

1281BG			
1281LPH/1	PH0-0,8x4 mm		
1281LPH/2	PH1-1x5,5 mm		
1281LPH/3	PH2-1,2x6,5 mm		
1281PZ/1	PZ1-PZ2		
1281PE	2,5 mm		
1281PE	3 mm		
1281PE	4 mm		
1281PE	5 mm		
1281PE	6 mm		

1281BG-TX/A8

assortment of 8 reversible screwdrivers and 1 accessory in case



1281BG-TX/A8		1	012810530
--------------	--	---	-----------

1281BG			
1281LPH/1	PH0-0,8x4 mm		
1281LPH/2	PH1-1x5,5 mm		
1281LPH/3	PH2-1,2x6,5 mm		
1281TX/1	T6-T8		
1281TX/2	T7-T9		
1281TX/3	T10-T15		
1281TX/4	T20-T25		
1281TX/5	T30-T40		

1281BG/B28A

set of 16 reversible screwdrivers,
9 1/4" drive sockets,
2 accessories and 1 handle, in wallet

14"



1281BG/B28A 1 012810510

○ 900	4 - 4,5 - 5 - 5,5 6 - 7 - 8 - 9 - 10 mm
1281BG	
1281PB	■ 1/4
900/25	
● 1281LP/1	0,8x4 - 1,2x6,5 mm
● 1281LP/2	1,0x5,5 - 1,2x6,5 mm
⊕ 1281PH/1	PH1 - PH2
⊕ 1281PH/2	PH2 - PH3
⊕ 1281PZ/1	PZ1 - PZ2
⊕ 1281PZ/2	PZ2 - PZ3
○ 1281PE	2,5 - 3 - 4 - 5 - 6 mm
⊕ 1281TX/1	T6 - T8
⊕ 1281TX/2	T7 - T9
⊕ 1281RTX/3	T10 - T15
⊕ 1281RTX/4	T20 - T25
⊕ 1281RTX/5	T30 - T40

1281/BV 1 012810501

1290

screwdrivers for slotted head screws



ISO 2380

SxAxL mm	L1 mm	Ø mm	
0,4x2,5x50	146	2,5	5 012900003
0,4x2,5x75	171	2,5	5 012900006
0,5x3x75	171	3,0	10 012900009
0,5x3x100	196	3,0	10 012900012
0,6x3,5x75	171	3,5	10 012900018
0,6x3,5x100	196	3,5	10 012900021
0,8x4x100	196	4,0	10 012900030
0,8x4x125	221	4,0	10 012900033
0,8x4x150	246	4,0	10 012900036
1x5,5x100	209	5,0	10 012900039
1x5,5x150	259	5,0	10 012900042
1,2x6,5x100	220	6,0	10 012900048
1,2x6,5x150	270	6,0	10 012900051
1,2x8x150	282	7,0	3 012900057
1,2x8x200	332	7,0	3 012900060
1,6x10x200	332	8,0	3 012900066
2x12x250	382	10	2 012900069

Beta INOX STAINLESS STEEL

1290/S

screwdriver set



1290/S5

1290 0,5x3x75-0,8x4x100 -1x5,5x150
1,2x6,5x150 -1,2x8x150 mm

1290/S9X

1290 0,4x2,5x75 - 0,5x3,5x100
0,8x4x125 - 1x5,5x150
1,2x6,5x150 - 1,2x8x200
1,6x10x200 mm
1290N 0,8x4x30 -1,2x6,5x30 mm

1290N

screwdrivers for slotted head screws
extra short series



ISO 2380

SxAxL mm	L1 mm	Ø mm	
0,8x4x30	86	4	5 012900103
1,2x6,5x30	86	6	5 012900106

1292

screwdrivers for cross head
Phillips® screws



UNI/ISO 8764

PHxDxL mm	L1 mm	
0x3x60	156	10 012920003
0x3x100	196	5 012920006
1x4,5x80	189	10 012920009
1x4,5x120	229	10 012920012
2x6x100	220	10 012920018
2x6x150	270	10 012920021
3x8x150	282	3 012920024
4x10x200	332	3 012920027

+



1292/S4

PH0x3x60-PH1x4,5x80
PH2x6x100-PH3x8x150 mm

1 012920304

1292N

screwdrivers for cross head
Phillips® screws
extra short series

+



UNI/ISO 8764

PHxDxL mm	L1 mm	
1x4,5x30	86	5 012920103
2x6x30	86	5 012920106

1292L

screwdrivers for cross head
Phillips® screws, long series

+

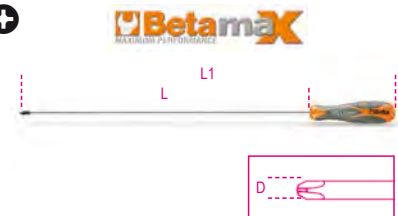

UNI/ISO 8764-1

PHxDxL mm	L1 mm	
0x3x300	396	3 012920203
1x4,5x400	509	3 012920206
2x6x400	520	3 012920209

Beta INOX STAINLESS STEEL

1293/D... screwdriver set



1293/D6 1 012930401

1290 0,6x3,5x75-1x5,5x150
1,2x6,5x150 mm
1292 PH0x3x60 -PH1x4,5x80
PH2x6x100 mm

1293/D8 1 012930403

1290 0,5x3x75-0,8x4x100
1x5,5x150-1,2x6,5x150
1,2x8x150 mm
1292 PH0x3x60 -PH1x4,5x80
PH2x6x100 mm

1293/S... screwdriver set



1293/S8 1 012930208

1290 2,5x50-3x75-4x100-5,5x150
6,5x150 mm
1292 PH0x3x60-PH1x4,5x80
PH2x6x100 mm

1293/S10 1 012930201

1290 0,4x2,5x50 -0,6x3,5x100
1x5,5x100-1,2x6,5x150
1,2x8x150-1,6x10x200 mm
1292 PH0x3x60 -PH1x4,5x80
PH2x6x100-PH3x8x150 mm

1293/S12 1 012930203

1290 0,5x3x75-0,8x4x125
1x5,5x150-1,2x6,5x150
1,2x8x200 mm
1290N 0,8x4x30 mm
1292 PH0x3x60 -PH1x4,5x80
PH2x6x100-PH3x8x150 mm
1292N PH1x4,5x30-PH2x6x30 mm

1293/S7 1 012930207

1292 PH0x3x60 -PH1x4,5x80
PH2x6x100 mm
1294 0,5x2,5x60-0,6x3x75
0,8x4x100-1x5x125 mm

1293ES hexagon drivers with handles



mm	L mm	L1 mm	Ø mm	
2	100	196	3	5 012930001
2,5	100	196	4	5 012930002
3	100	196	4	5 012930003
4	100	196	5	5 012930004
5	100	209	6	5 012930005
6	125	245	7	5 012930006
8	150	282	10	2 012930008



1293ES/S7 1 012930057
2-2,5-3-4-5-6-8 mm

1293BP ball head hexagon drivers with handles



mm	L mm	L1 mm	
2	100	196	5 012930501
2,5	100	196	5 012930502
3	100	196	5 012930503
4	100	196	5 012930506
5	100	209	5 012930509
6	125	245	5 012930512
8	150	282	2 012930515



1293BP/S7 1 012930558
2-2,5-3-4-5-6-8 mm

1294 screwdrivers for headless slotted screws

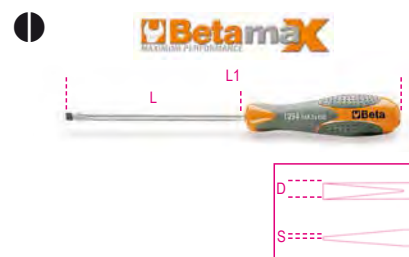

SxDxL mm	L1 mm	
0,5x2,5x60	156	5 012940003
0,6x3x75	171	5 012940006
0,6x3x100	196	5 012940009
0,8x4x100	196	5 012940012
0,8x4x150	246	5 012940015
1x5x125	234	5 012940018
1,2x6,5x150	282	5 012940027



1294/S5 1 012940305
0,5x2,5x60-0,6x3x100
0,8x4x100-1x5x125
1,2x6,5x150 mm

1294L screwdrivers for headless slotted screws long series

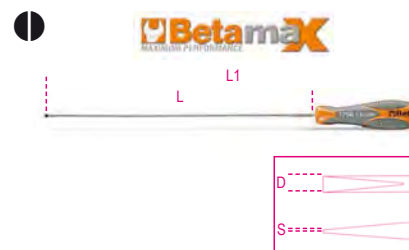

SxDxL mm	L1 mm	
0,6x3x300	396	3 012940206
0,8x4x400	496	3 012940209
1x5x400	509	3 012940215
1,2x6,5x400	532	3 012940218

1295 impact screwdriver









1295 1 012950001
L 130 mm

1295/C14

impact screwdriver
with 14 insets and 1 socket holder



1295/C14  1 012950108



	866LP	1,2x6,5 - 1,6x10 mm
	866PH	PH2 - PH3
	866PZ	PZ2 - PZ3
	866PE	5 - 6 mm
	866TX	T27 - T30 - T40 - T45 - T50 - T55
	895/6	□ 1/2 - ○ 5/16
	1295	■ 1/2

170x100x35 mm - 1,3 kg

1297TX

drivers for Torx® head screws,
with handles



⊕	L	L1	∅		
	mm	mm	mm		
T6	50	146	3,0	5	012970006
T7	50	146	3,0	5	012970007
T8	60	156	3,0	5	012970008
T9	60	169	4,0	5	012970009
T10	80	189	4,0	5	012970010
T15	80	189	4,0	5	012970015
T20	100	209	4,5	5	012970020
T25	100	209	5,0	5	012970025
T27	115	235	6,0	5	012970027
T30	115	235	6,0	5	012970030
T40	130	262	7,0	2	012970040
T45	130	262	8,0	2	012970045



1297TX/S12  1 012970312
T6-T7-T8-T9-T10
T15-T20-T25-T27
T30-T40-T45





1297TX/D6  1 012970409
T10-T15-T20
T25-T27-T30

1297TX/L

drivers for Torx® head screws, long series



⊕	L	L1	∅		
	mm	mm	mm		
T15	210	319	4,0	2	012970115
T20	210	319	4,5	2	012970120
T25	210	319	5,0	2	012970125
T30	210	330	6,0	2	012970130
T45	210	342	8,0	2	012970145





1297TX/L-S5  1 012970325
TX/L15-TX/L20-TX/L25-
TX/L30-TX/L45

1298RTX

screwdrivers for Tamper Resistant Torx®
head screws, with handles



⊕	L	L1	∅		
	mm	mm	mm		
T9	60	169	4,0	5	012980009
T10	80	189	4,0	5	012980010
T15	80	189	4,0	5	012980015
T20	100	209	4,0	5	012980020
T25	100	209	4,5	5	012980025
T27	115	235	5,5	5	012980027
T30	115	235	6,0	5	012980030
T40	130	262	7,0	2	012980040





1298RTX/S8  1 012980308
T9-T10-T15-T20
T25-T27-T30-T40

1299PZ

screwdrivers for cross head
Pozidriv®-Supadriv® screws



UNI/ISO 8764

PZ	L	L1		
	mm	mm		
0	60	156	5	012990000
1	80	189	5	012990003
2	100	220	5	012990006
3	150	282	2	012990009
4	200	332	2	012990012



1299PZ/S6  1 012990306
1299PZ PZ0-PZ1-PZ2-PZ3
1299N/PZ PZ1-PZ2

1299N/PZ

screwdrivers for cross head
Pozidriv®-Supadriv® screws
extra short series





UNI/ISO 8764

PZ	L	L1		
	mm	mm		
1	30	86	5	012990021
2	30	86	5	012990024

1302

double end dolly, round,
convex pein head



 770  1 013020001

1303
curved dolly



g 1350 1 013030001

1304
sole dolly



g 875 1 013040001

1305
toe dolly



g 1190 1 013050001

1305Z
milled toe dolly



g 1065 1 013050002

1306
heel dolly



g 1040 1 013060001

1307
regular dolly



g 1100 1 013070001

1308
egg dolly



g 1100 1 013080001

1309
hatchet dolly



g 460 1 013090001

1310
general purpose dolly



g 1225 1 013100001

1312
anvil dolly



g 1220 1 013120001

1313
buffer dolly



g 990 1 013130001

1314
double end dolly, convex, flat head



g 760 1 013140001

1326
curved angle spoon



g 560 1 013260001

1327
heavy-duty spoon



g 1075 1 013270001

1328
pry and bumping spoon



g 935 1 013280001

1329

double-ended spoon



435 mm

g 1800 1 013290001

1330

long double-ended spoon



510 mm

g 2125 1 013300001

1331

bending iron with leather face



410 mm

g 1100 1 013310001

1335BM

bumping blade with plastic handle



375 mm

g 500 2 013350010

1337/S5

set of 5 stopping knives for car repairers, made of stainless steel

Japanese type (25-50-75-100-125 mm)



L

L mm 25-50-75-100-125 1 013370015

1338A - 1338B

adjustable body blade holder with flexible flat blades



L

1338A	9	360	2	013380001
1338B	12	360	2	013380002

1338

body blade holder for item 1338R



1338 2 013380003

1338R9 - 1338R12

spare body blades for item 1338A-B



1338R9	9	2	013380004
1338R12	12	2	013380005

1342

extra flat chisel with straight cutter



L mm 235 5 013420001

1342PM

extra flat chisel with straight cutter with hand guard

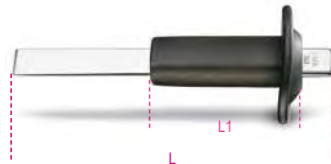

L mm	L1 mm	2	013420002
235	118		

1342PMR

spare hand guard for item 1342



1342PMR 1 013420003

1343

flat chisel with side cutter



L mm 200 5 013430001

1344

feeler gauges for car body repair shops, pair, 10-bladed, with suction cup

suitable for:
• fitting rear windows
• maintaining position during installation



1344 1 013440010

1345

hammer with round, convex face and pein, wooden shaft



1345 2 013450010

1351

hammer with round, flat face and ball pein, wooden shaft



1351 2 013510010

1353

hammer with round, flat face and point pein, wooden shaft



1353 2 013530010

1357Z/45

hammers with flat, round, milled face and square, smooth face, wooden shafts



1357Z/45 2 013570045

1359T

hammer with round, flat face and horizontal pein, wooden shaft



1359 T 2 013590010

1360G

soft dead-blow rubber hammer, for installing gaskets and delicate parts

The extremely soft faces prevent any parts being worked on from getting damaged, as they absorb impact by getting deformed.



L mm 280, Ø mm 72, 1 013600000

1360/K6

aluminium hammer with flat, round face, interchangeable plastic pins and punch

supplied with:
• 4 plastic pins
• 1 punch, adjustable in 2 different lengths, applicable to hammer



L mm 320, Ø mm 34, 1 013600006

1360/KP3

hammers with ball heads and point peins/punches, made of plastic

Kit contents:
• 1 210 g hammer with head Ø 30 mm
• 1 290 g hammer with head Ø 40 mm
• 1 175 g punch with 5 mm pein



1360/KP3 1 013600503

1361/C12

set of Teflon® rods for body repair shops



1361/C12 1 013610012

275x160x57 mm

1362

dent reflector with suction cup

allows even the smallest bodywork imperfections to be detected



1362 240 x200 1 013620010

1365/K13

oil pressure pump, 10 t, and bodywork accessories kit in trolley

Kit contents:
• oil pressure pump, 10 t, with 1.5-m-long hose, 1/2" coupling
• piston
• wing opening pliers; capacity: 500 kg
• baseplate, 150x90 mm
• L-shaped base, 50x50 mm
• 4-point punch
• round, knurled punch, Ø 50 mm
• wedge-shaped punch, 43 mm
• 240-mm-long extension
• 450-mm-long extension
• 475-mm-long extension
• rubber head
• male-to-male coupling for installing accessories



1365/K13 1 013650013

900x420x180 mm

1365P10

oil pressure pump
1.5-m-long hose, 1/2" coupling



1365P10 1 013650110

1366A

dent puller with kit of 19 plastic glue tabs

ideal for removing:
• hail dents
• dents caused by doors
• small dents in general



1366A 1 013660200



1366KF

kit of 19 plastic glue tabs
for item 1366A



1851VK-12V - 018510072 233

1366KF

1 013660205

1366/K5

pneumatic dent puller, with 1.1 kg hammer
face

Kit contents:

- 1 suction cup Ø 75 mm
- 1 suction cup Ø 100 mm
- 1 suction cup Ø 125 mm
- 1 hook



1366/K5

1 013660010

610x240x90 mm

1366S

wheeled bodywork spotter

- microprocessor for managing welding parameters
- welding power and time adjustment
- adjustment range: 400÷2200 Ah
- single, pulsed, continuous point selector
- welding parameters table
- thermal protection indicator
- quick coupling gun
- voltage: 230 V

CE



1366S

1 013660000

1366S KIT

spotter accessory kit

- 10 slotted washers
- 10 90° slotted washers
- 100 threaded pins, 5x18 mm
- 100 self-threading pins, 5x18 mm
- 100 self-threading pins, 5x25 mm
- washer hook, Ø 8x16x1.5 mm
- electrode for M5-M6 screws
- electrode for slotted washers



1366S KIT

1 013660001

250x170x35

1366SL

pulling lever
for repairing dents on metal surfaces

articulated multihook head
for use with crimped wire



L
mm
700

1 013660002

1366ST

crossbar
for repairing dents on metal surfaces

articulated multihook head
for use with crimped wire



L
mm
850

1 013660003

1366S/R1

3-pointed washer mandrel



1366S/R1

1 013660501

1366S/R2

3-pointed washer
for pulling sheets



1366S/R2

1 013660502

1366S/R3

electrode for washers
Ø 8x16x1.5 mm



1366S/R3

1 013660503

1366S/R4

washer hook, Ø 8x16x1.5 mm



1366S/R4

1 013660504

1366S/R5

washers Ø 8x16x1.5mm



1366S/R5

1 013660505

1366S/R6

electrode for M5-M6 screws



1366S/R6

1 013660506

1366S/R7

100 self-threading pins, 5x18 mm



1366S/R7

1 013660507

1366S/R8
100 self-threading pins, 5x25 mm



1366S/R8 1 013660508

1366S/R9
100 threaded pins, M5 x 18 mm



1366S/R9 1 013660509

1366S/R10
10 slotted washers



1366S/R10 1 013660510

1366S/R11
electrode for slotted washers



1366S/R11 1 013660511

1366S/R12
10 90° slotted washers



1366S/R12 1 013660512

1366S/R13
sheet flattening electrode



1366S/R13 1 013660513

1366S/R14
wire spot welding electrode



1366S/R14 1 013660514

1366S/R21
crimped wires for use of
pulling lever and crossbar



1366S/R21 1 013660551

1366S/R22
magnetic support
for crimped wire



1366S/R22 1 013660552

1366S/R24
pull ring M4



1366S/R24 1 013660554

1366S/R25
pull ring M5



1366S/R25 1 013660555

1366S/R26
pull ring M6



1366S/R26 1 013660556

1367/S4
set of punches for installing
parking sensors
sizes:
23 - 24 - 27 - 28



1367/S4 1 013670104

1367/K10
kit of punches for installing parking sensors

Kit contents:
• sizes: 17 - 18 - 18.2 - 19 - 20 - 22.5 - 24 - 26 - 26.7 - 32 mm



∅ 12 mm

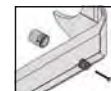

1367/K10 1 013670200

190x130x58 mm



1368

plastic repair kit

- Allows cracked and broken plastic parts to be quickly fixed

Power supply: 220+240 V with Schuko socket
 Heat gun cable length: 3.5 m
 Power supply cable length: 1.35 m
 2 power adjustments: 35-75 W
 Heat gun with brass terminals, 2 staple insertion angles:
 0°-90°
 Input protection: thermal circuit breaker
 Output protection: 10 A fuse
 Metal gun pocket

CE



1368 1 013680001

1368G/K400

assortment of 400 clips
 for item 1368

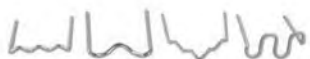

1368G/K400 1 013680140

1368G/OD

corrugated clips, straight, for item 1368



1368G/OD 1 013680100

1368G/SD

spiral clips, straight, for item 1368



1368G/SD 1 013680110

1368G/CV

convex angle clips for item 1368



1368G/CV 1 013680120

1368G/C2U

concave angle clips for item 1368



1368G/C2U 1 013680130

1369/C11

assortment of 11 tools



1369/C11 1 013690033



470x340x70 mm - 15,2 kg

1370

engineer's hammers, wooden shaft



UNI 7778 DIN 1041

g	A mm	L mm	L1 mm	
100	15	260	82	5 013700051
200	19	280	95	5 013700052
300	23	300	105	5 013700053
400	25	310	112	5 013700054
500	27	320	118	5 013700055
600	30	330	122	5 013700056
800	33	350	130	4 013700058
1000	36	360	135	4 013700060
1500	42	380	145	2 013700065
2000	47	400	155	1 013700070

1370/MR...

spare shafts for item 1370



1370MR 100 1370/100	4	013700081
1370MR 200 1370/200	4	013700082
1370MR 300 1370/300	4	013700083
1370MR 400 1370/400	4	013700084
1370MR 500 1370/500	4	013700085
1370MR 600 1370/600	4	013700086
1370MR 800 1370/800	4	013700088
1370MR 1000 1370/1000	4	013700090
1370MR 1500 1370/1500	4	013700095
1370MR 2000 1370/2000	4	013700100

1370T

mechanic's hammers
 fibre shaft



g	A mm	L mm	L1 mm	
200	19	280	95	5 013700620
300	23	300	105	5 013700630
500	27	320	118	5 013700650
800	33	350	130	4 013700680
1000	36	360	135	4 013700700
1500	42	365	145	2 013700750

1370F

riveting hammers, wooden shaft



NF E 71.014

A mm	L mm	L1 mm	g	
24	260	77	280	2 013700424
26	260	80	310	2 013700426
28	280	86	400	2 013700428
30	280	92	450	2 013700430
32	300	100	550	2 013700432
36	300	104	720	2 013700436
40	330	110	1065	2 013700440
42	330	116	1080	2 013700442
50	380	138	1760	2 013700450
60	380	160	2585	2 013700460

1370F/MR...

spare shafts for item 1370F



1370F/MR 24	2	013700474
1370F/24-26		
1370F/MR 28	2	013700478
1370F/28-30		
1370F/MR 32	2	013700482
1370F/32-36		
1370F/MR 40	2	013700490
1370F/40-42		
1370F/MR 50	2	013700495
1370F/50		
1370F/MR 60	2	013700496
1370F/60		

1370FT

riveting hammers, fibre shafts



A	L	L1	g		
mm	mm	mm			
28	280	86	530	1	013700528
30	280	92	625	1	013700530
32	300	100	750	1	013700532
36	300	104	930	1	013700536
40	330	110	1150	1	013700540
42	330	116	1250	1	013700542
50	380	138	2100	1	013700550
60	380	160	2750	1	013700560

1374F

carpenter's hammers, wooden shaft



NF E 71.012

A	L	L1	g		
mm	mm	mm			
16	250	80	180	2	013740416
20	270	86	250	2	013740420
22	290	92	335	2	013740422
26	290	103	425	2	013740426
28	310	108	510	2	013740428
30	310	117	580	2	013740430

1374F/MR...

spare shafts for item 1374F



1374F/MR 16	2	013740456
1374F/16		
1374F/MR 20	2	013740460
1374F/20		
1374F/MR 22	2	013740462
1374F/22-26		
1374F/MR 28	2	013740468
1374F/28		
1374F/MR 30	2	013740470
1374F/30		

1375

claw hammer, wooden shaft



g	L1	Ø	L		
mm	mm	mm	mm		
300	95	25	300	3	013750000

1375/MR

spare shafts for item 1375



1375/MR	2	013750003
---------	---	-----------

1375A

claw hammers, plastic shafts



oz	g	L	L1		
		mm	mm		
16	450	330	130	3	013750016
20	570	330	130	3	013750020

1375B

claw hammers, steel shafts



oz	g	L	L1		
		mm	mm		
16	450	330	130	3	013750026
20	570	330	130	3	013750030

1376X

claw hammers with square peins, magnets and nail holders wooden shaft



g	A	L1	L		
mm	mm	mm	mm		
250	20	125	450	3	013760125
300	25	130	450	3	013760130
400	27	132	450	3	013760140

1376X/MR

spare shaft for item 1376X



1376X/MR	2	013760161
----------	---	-----------

1376XT

claw hammers with square peins, magnets and nail holders plastic shaft



g	A	L1	L		
mm	mm	mm	mm		
250	20	125	500	3	013760525
300	25	130	500	3	013760530
400	27	132	500	3	013760540

1376XT/MR

spare shaft for item 1376XT



1376MR/XT	2	013760585
-----------	---	-----------

1377

ball pein hammers, round heads, for coppersmiths and tinsmiths, wooden shafts



HICKORY

g	L	L1		
mm	mm	mm		
340	330	95	2	013770134
450	350	102	2	013770145
570	350	110	2	013770157
680	360	116	2	013770168
900	380	120	2	013770190

1377/MR...

spare shafts for item 1377



1377MR 340	2	013770234
1377/340		
1377MR 450	2	013770245
1377/450		
1377MR 570	2	013770257
1377/570		
1377MR 680	2	013770268
1377/680		
1377MR 900	2	013770290
1377/900		

1377T

ball pein hammers,
round heads,
for coppermiths and tinsmiths,
fibre shafts



g	L mm	L1 mm		
340	330	95	2	013770534
450	350	102	2	013770545
570	350	110	2	013770557
680	360	116	2	013770568
900	380	120	2	013770590

1378

joiner's hammers, round heads
and peins, wooden shaft



g	L mm	L1 mm	Ø mm		
340	330	100	27	2	013780134
570	350	115	32	2	013780157

1378/MR...

spare shafts for item 1378



1378MR 340	2	013780234
1378/340		
1378MR 570	2	013780257
1378/570		

1379F

electrician's hammers, wooden shafts



NF E 71.011

A mm	L mm	L1 mm		
16	250	126	2	013790416
18	250	135	2	013790418
20	260	142	2	013790420

1379F/MR...

spare shafts for item 1379F



1379F/MR 16	2	013790426
1379F/16-18		
1379F/MR 20	2	013790430
1379F/20		

1380

lump hammers, wooden shafts



UNI 7777 DIN 6475

g	A mm	L mm	L1 mm		
800	38	260	90	2	013800208
1000	40	260	95	2	013800210
1250	43	260	100	2	013800212
1500	45	280	110	2	013800215
2000	50	300	120	2	013800220

1380/MR...

spare shafts for item 1380



1380MR 800	2	013800238
1380/800-1000-1250		
1380MR 1500	2	013800245
1380/1500		
1380MR 2000	2	013800250
1380/2000		

1380S

mason club hammers with security collars
wooden shafts



g	A mm	L mm	L1 mm		
800	36	260	90	2	013800400
1000	39	260	95	2	013800405
1250	43	260	100	2	013800410
1500	45	260	110	2	013800415

1380S/MR...

spare shafts for item 1380S



1380S/MR 800	2	013800417
1380S/800-1000-1250		
1380S/MR 1500	2	013800419
1380S/1500		

1380T

Mason club hammers,
fibre shafts



g	A mm	L mm	L1 mm		
800	35	260	85	2	013800308
1000	40	260	100	2	013800310
1250	42	260	110	2	013800312
1500	45	260	120	2	013800315
2000	49	295	120	1	013800320

1381

sledge hammers, Hickory shafts



g	A mm	L mm	L1 mm		
3000	55	800	142	1	013810030
4000	60	900	152	1	013810040
5000	70	900	162	1	013810050
8000*	80	900	185	1	013810080

* = ash shaft

1381/MR...

spare shafts for item 1381



1381MR 3-4	2	013810730
1381/3000-4000		
1381MR 5	2	013810750
1381/5000		
1381MR 8	2	013810780
1381/8000		

1381T

sledge hammers,
fibre shafts



g	A mm	L mm	L1 mm		
3000	55	900	142	1	013810330
4000	60	900	152	1	013810340
5000	70	900	162	1	013810350
8000	82	920	180	1	013810380

1385

copper head hammers, wooden shafts



g	A	L	L1		
mm	mm	mm	mm		
400	26	260	75	2	013850404
600	32	270	80	2	013850406
800	34	280	90	2	013850408
1000	37	280	100	2	013850410
1500	43	280	110	2	013850415
2000	48	300	120	1	013850420

1385/MR

spare shafts for item 1385



1385MR 400	2	013850464
1385 400		
1385MR 600	2	013850466
1385 600		
1385MR 800	2	013850468
1385 800		
1385MR 1000	2	013850470
1385 1000		
1385MR 1500	1	013850475
1385 1500		
1385MR 2000	1	013850480
1385 2000		

1390

soft face hammers, wooden shafts



UNI 7784					
Ø	L	L1			
mm	mm	mm			
22	260	70	5	013900022	
28	280	85	5	013900028	
35	310	95	5	013900035	
45	320	107	4	013900045	
60	380	128	2	013900060	

1390/MR...

spare shafts for item 1390



1390MR 22	2	013900222
1390/22		
1390MR 28	2	013900228
1390/28		
1390MR 35	2	013900235
1390/35		
1390MR 45	2	013900245
1390/45		
1390MR 60	2	013900260
1390/60		

1390R

spare faces for item 1390



Ø		
mm		
22	4	013900122
28	4	013900128
35	4	013900135
45	4	013900145
60	4	013900160

1390N

nylon face hammers, wooden shafts

Medium-hard faces: 75 Shore
Oil and wear resistant
Particularly suitable for working metal



UNI 7784					
Ø	L	L1			
mm	mm	mm			
22	260	70	3	013900522	
28	280	85	3	013900528	
35	310	95	3	013900535	
45	320	107	2	013900545	
60	380	128	2	013900560	

1390NR

spare nylon faces for item 1390N



Ø		
mm		
22	4	013900622
28	4	013900628
35	4	013900635
45	4	013900645
60	4	013900660

1391

dead-blow hammers, entirely covered with rubber



Ø	L	L1		
mm	mm	mm		
35	280	90	2	013910135
50	320	105	2	013910150
55	355	110	2	013910155
65	380	130	2	013910165

1391A

dead-blow hammers for tile workers, entirely covered with rubber



g	Ø	L	L1		
mm	mm	mm	mm		
500	45	290	100	2	013910205
1000	60	300	120	2	013910210

1392

dead-blow hammers, with interchangeable plastic faces, steel shafts



Ø	L	L1		
mm	mm	mm		
30	300	105	2	013920030
35	305	115	2	013920035
40	310	125	2	013920040
50	325	135	2	013920050
60	385	155	2	013920060

1392R

spare faces for item 1392

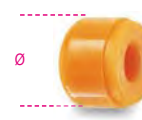

Ø		
mm		
30	4	013920230
35	4	013920235
40	4	013920240
50	4	013920250
60	4	013920260

1393

hard rubber head hammers



Ø	L	L1		
mm	mm	mm		
50	315	90	3	013930050
60	340	110	3	013930060
70	370	130	2	013930070

1410/M

spring pulling hook wrench



∅ mm			
3,5		2	014100051

1428

pullers for damaged nuts with square drive



∅ mm	∅ mm	L mm	∅ mm		
8	3/8	36	17	2	014280008
10	3/8	36	17	2	014280010
11	3/8	36	17	2	014280011
12	3/8	36	19	2	014280012
13	3/8	36	19	2	014280013
14	3/8	36	19	2	014280014
15	1/2	38	21	2	014280015
16	1/2	38	21	2	014280016
17	1/2	38	21	2	014280017
18	1/2	38	26	2	014280018
19	1/2	38	26	2	014280019
20	1/2	38	26	2	014280020
21	1/2	38	26	2	014280021
22	1/2	38	26	2	014280022
24	1/2	38	26	2	014280024
27	1/2	38	26	2	014280027

1428L

socket pullers, long series, for damaged right-hand nuts, with square drive



∅ mm			
17		1	014280217
19		1	014280219
21		1	014280221



1428L/B3	1	014280303
17-19-21 mm		



1428/SB11	1	014280111
8-10-11-12-13-14		
15-16-17-18-19 mm		
1428/SB5	1	014280115
20-21-22-24-27 mm		

1429

pullers for damaged screws and stud bolts with square drive



mm	∅	L mm		
2	3/8	60	3	014290002
3	3/8	60	3	014290003
4	3/8	60	3	014290004
5	3/8	60	2	014290005
6	3/8	60	2	014290006
8	1/2	70	2	014290008
10	1/2	70	2	014290010



1429/SB7	1	014290107
2-3-4-5-6-8-10 mm		

1430/...

tapered extractors for broken screws and studs made from hardened and tempered steel

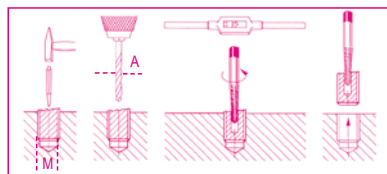

	M	A mm		
1430/1	3÷6	2,5	10	014300006
1430/2	6÷8	3,0	10	014300008
1430/3	8÷11	4,5	10	014300011
1430/4	11÷14	6,0	10	014300014
1430/5	14÷18	8,0	10	014300018
1430/6	18÷24	11,0	5	014300024
1430/7	24÷33	14,0	5	014300033
1430/8	33÷50	21,0	5	014300050



1430/S5	1	014300105
1430/1-1430/2-1430/3		
1430/4-1430/5		
1430/S6	1	014300106
1430/1-1430/2-1430/3		
1430/4-1430/5-1430/6		
1430/S8	1	014300108
1430/1-1430/2-1430/3		
1430/4-1430/5-1430/6		
1430/7-1430/8		

1431/...

tapered extractors for broken screws and studs

For removing screws and studs that cannot be held firmly, percussion mechanism

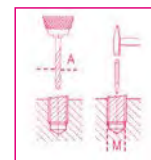

	M	A	L mm		
1431/3	3÷6	2,5	59	5	10 014310051
1431/5	6÷8	5,0	68	5	10 014310052
1431/6	8÷11	6,0	72	6	10 014310053
1431/8	11÷14	8,0	77	8	10 014310054
1431/9	14÷18	9,0	82	9	10 014310055

1431/C5

tapered extractors for broken screws and studs

Percussion mechanism



	M mm	A mm		
1431/C5	6÷18	3÷9	1	014310005

1433

roller stud extractors

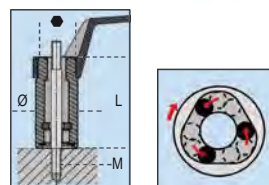

M mm	∅ mm	L mm	∅ mm	∅		
5	21	60	19	3/8	2	014330005
6	24	60	21	1/2	2	014330006
7	24	60	21	1/2	2	014330007
8	24	60	21	1/2	2	014330008
9	28	70	21	1/2	2	014330009
10	28	70	21	1/2	2	014330010
10,5	28	70	21	1/2	2	014330021
11	28	70	21	1/2	2	014330011
12	28	70	21	1/2	2	014330012
14	36	72	24	-	2	014330014
16	36	72	24	-	2	014330016



1433/C11

roller stud extractors
with 1/2" female square drives



1433/C11
M5 - M6 - M7 - M8 - M9 - M10 - M10,5
M11 - M12 - M14 - M16

340x135x56 mm - 3,0 kg

1 014330311

1435

eccentric stud extractor

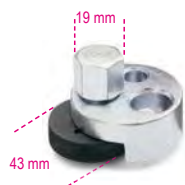

∅
mm
4±20

1 014350001

1435R

spare wheel for item 1435



1435R

1 014350010

1435/1

eccentric stud extractor



∅
mm
19±26

1 014350002

1435/1R

spare wheel for item 1435/1

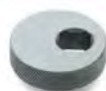

1435/1R

1 014350011

1437/C12

assortment of 12 tools for removing air bags



1437/C12

260x160x55 mm - 1,0 kg

1 014370001

1438

universal clutch aligner complete
with 3 expansion mandrels



1438

1 014380001

1438R

spare expansion mandrels
for item 1438



∅
mm
14±18
18±21
22±25

5 014380101
5 014380102
5 014380103

1438DCT

tool for removing and installing 6-speed DCTs

for use on Volvo, Ford, Chrysler and Dodge vehicles



1438DCT

1 014380300

1438EVO

universal clutch aligning kit

Component parts made entirely from metal



1438EVO

290x200x60 mm - 2 kg

1 014380011

1438DSG

lever for locking/unlocking DSG dual-clutch
gearbox
from VAG group



1438DSG

1 014380200

1438SAC

SAC clutch aligning kit

includes kit for applications without guide bearings
supplied with 3 and 4 arm plates



1438 SAC

480x380x130 mm - 9,5 kg

1 014380050

1439/K7

angular screwdriver (90°), long series, with blades, in case



Case contents:
- Angular screwdriver
- 1 slotted screw head
- 1 1/4" bit head
- Special blade head
- 7 special blades

1439K7 1 014390101

500x120x60 mm 825 g

1440/...

piston ring compressors



	Ø mm	L mm	
1440/0	40÷75	50	1 014400000
1440/1	57÷125	80	1 014400010
1440/1A	57÷125	100	1 014400011
1440/2	90÷175	80	1 014400020
1440/2A	90÷175	100	1 014400021
1440/3	90÷175	165	1 014400030

1445/1 - 1445/2

piston ring expanders



	Ø mm	
1445/1	50÷100	1 014450001
1445/2	90÷150	1 014450002

1450GC

valve spring compressor with straight and offset jaws



1450GC 1 014500005

1452K

valve spring compressor, with three flanges

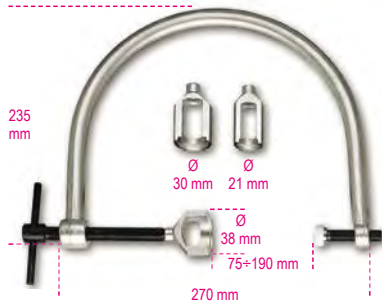

1452K 1 014520100

1452PN/K

pneumatic tool for engine valve springs

Thrust pressure: 1400 N



Ø mm	L mm	L1 mm	
16-19-23	230	185	1 014520110
25-30-42			

1455SVP

pneumatic valve grinder

• Pressure: 6 bars

CE



1455SVP 1 014550001

1455SVP/R...

spare parts for item 1455SVP



1455SVP/R1	5	014550501
1455SVP/R2	5	014550502
1455SVP/R3	5	014550503

1456/C8

head gasket alignment kit

allows quick, precise head gasket alignment

Kit contents:

- 1 pair of guide pins M10x1.5, 60 mm long
- 1 pair of guide pins M10x1.5, 35 mm long
- 1 pair of guide pins M9x1.25, 55 mm long
- 1 handle for removing guide pins
- 1 extension for removing guide pins



Ø 8 mm

1456/C8 1 014560010

300x90x65 mm - 650 g

1457/B4

tool set for releasing Rilsan hose fittings

Sizes included in set:

- 6x8
- 10x12
- 15x16
- 18x12



1457/B4 1 014570024

Beta

Beta
Quality Tools

1458

external butt-ended circlip pliers



DIN 5417

200 mm

Ø mm
30±100

1 014580001

1460F

valve seat removing tool



270 mm

1460F

1 014600010

1461/C3B

timing devices for
Fiat/Alfa/Lancia petrol engines

Engines: 1.2-1.4 16V



1461/C3B

280x245x75 mm 1,5 kg

1 014610032

1461/C5G

timing devices for Fiat/Alfa/Lancia/Opel/
Suzuki/Ford
diesel engines

Engines: 1.3 Multijet



1461/C5G

280x245x75 mm 2,6 kg

1 014610053

1461/C6B

timing devices for
Peugeot/Citroën petrol engines

Engines: 1.0-1.1-1.4-1.6-1.6 16v-1.6Gti-1.6 18V-1.8-1.8 16v-1.9-
2.0-2.0 16v-2.0T-2.0 Hpi-2.2 16v



1461/C6B

310x290x120 mm 3,5 kg

1 014610063

1461/C6G

timing devices for
Peugeot/Citroën diesel engines

Engines: 1.4-1.6-2.0D,1.4-1.6TDCI, 1.4-1.6-2.0-2.2Hdi,
1.5-1.9-2.5D



1461/C6G

385x290x100 mm 3,8 kg

1 014610064

1461/C7B

timing devices for
Renault/Nissan petrol engines

Engines: 1.4-1.6-1.8-2.0 16V



1461/C7B

280x245x75 mm 3,2 kg

1 014610072

1461/C8B

timing devices for Ford petrol engines

Engines: 1.25-1.4-1.6-1.6 SCTi-1.6 Ti-VCT-1.6 16V



1461/C8B

240x210x50 mm 1,8 kg

1 014610083

1461/C8G

timing devices for Ford/Mazda diesel engines

Engines: 1.4-1.6-1.8-2.0-2.2 TDCi, 1.6D 8/16V, 1.8D,
1.8D Turbo, 1.8 TCi, 1.8 TDDi, 2.5D, 2.5D Turbo



1461/C8G

280x245x75 mm 2,2 kg

1 014610084

1461/C9B

timing devices for Opel petrol engines

Engines: 1.0 12V, 1.0-1.2-1.4 16V



1461/C9B

335x145x60 mm 2 kg



1 014610092

1461/C10G

timing devices for
Volkswagen/Audi/Seat and Skoda engines

Engines: 1.2-1.6-2.0 TDI CR (common rail)





1461/C10G  1 014610103
≡ 310x290x120 mm  2,8 kg

1461/C11A

timing devices for
Renault engines

Engines: 2.0 dCi





1461/C11A  1 014610111
≡ 420x280x60 mm -  1,2 kg

1461/C11G

timing devices for
Renault engines

Engines: 1.5-1.9-2.2-2.5 DCI



1461/C11G  1 014610113
≡ 310x290x120 mm  3,8 kg



Beta

1461/C12A

timing devices for
Fiat engines

Engines: 1.9-2.2 JTS and 1.9 JTD Euro 4



1461/C12A  1 014610123
≡ 280x245x75 mm -  1,8 kg

1461/C12G

timing devices for
Fiat/Alfa/Lancia diesel engines

Engines: 1.9 JTD, 1.6-1.9-2.0 Multijet





1461/C12G  1 014610124
≡ 280x245x75 mm  2 kg

1461/C13A

timing devices for Fiat 0.9 Twinair turbo
engines





1461/C13A  1 014610133
≡ 240x210x50 mm  1,7 kg

1461/C13B

timing devices for Fiat 1.4 Multiair engines



1461/C13B  1 014610134
≡ 240x210x50 mm  2,8 kg

1461/C17B

timing devices for
Volkswagen/Audi/Seat and Skoda petrol
engines

Engines: 1.2 TSI





1461/C17B  1 014610171

1461/C18B

timing devices for
Volkswagen/Audi/Seat and Skoda petrol
engines

Engines: 1.6-1.8-1.8T, 1.4-1.6-1.8-2.0 16V,
1.4-1.6-2.0 FSI



1461/C18B  1 014610182
≡ 310x290x120 mm  2,5 kg

Beta

Beta

1461/C20G

timing devices for Fiat Iveco/Peugeot/Citroën/Ford diesel engines

Engines: 2.2-2.3-3.0 Multijet



1461/C20G

1 014610221

≡ 385x290x100 mm 📦 5,5 kg

1461/C21G

timing devices for Renault diesel engines

Engines: 1.6 dCi



1461/C21G

1 014610222

≡ 310x290x120 mm 📦 3 kg

1461/C22B

timing devices for Peugeot/Citroën petrol engines

Engines: 1.0-1.2 VTi



1461/C22B

1 014610223

≡ 280x245x75 mm 📦 2 kg

1461/C23B

timing devices for Opel petrol engines

Engines: 1.0 - 1.2 - 1.4 ecoflex



1461/C23B

1 014610224

≡ 280x245x75 mm 📦 2,5 kg

1461/C24B

timing devices for Mini-Peugeot/Citroën petrol engines

Engines: 1.4 - 1.6 (N12-N14)



1461/C24B

1 014610225

≡ 280x245x75 mm 📦 2,8 kg

1461/C25G

timing devices for Mini diesel engines

Engines: 1.6 diesel (W16D)



1461/C25G

1 014610226

≡ 270x120x45 mm 📦 1 kg

1461/C26B

timing devices for Fiat/Alfa Romeo/Lancia petrol engines

Engines: 1.2-1.4 8v



1461/C26B

1 014610227

≡ 280x245x75 mm 📦 1,7 kg

1461/C27G

timing devices for Bmw diesel engines

Engines: 1.6-2.0D (N47-N47S)



1461/C27G

1 014610228

≡ 280x245x75 mm 📦 2 kg

1461/C28B

timing devices for Volkswagen, Seat and Skoda petrol engines

engines: 1.0 - 1.0 Bluemotion Tech
1.0 Ecofuel/Ecomotive - 1.0 Green Tech



1461/C28B

1 014610229

≡ 280x245x75 mm - 📦 1,7 kg

1461/C29B

timing devices for
Ford petrol engines
engines: 1.0 EcoBoost



1461/C29B 1 014610209

280x245x75 mm - 2,6 kg

1461/C30G

timing devices for
Volkswagen/Audi/Seat and Skoda diesel
engines
engines: 1.6-2.0 CR TDI
for engines built as from 2012



1461/C30G 1 014610231

280x245x75 mm - 2 kg

1461/C31B

timing devices for Volkswagen/Audi/Seat and
Skoda petrol engines

Engines: 1.0-1.2-1.4 TSI/TFSI



1461/C31B 1 014610232

270x230x80 mm - 2,1 kg

1461/C32G

timing devices for Opel diesel engines

Engines: 1.6 CDTi (B16)



1461/C32G 1 014610233

270x230x80 mm - 1,3 kg

1461/C33B

timing devices for Opel petrol engines

Engines: 1.0 - 1.0 Turbo SIDI Ecoflex



1461/C33B 1 014610234

1462CF/C6

set of 6 single-ended bi-hex wrenches
for fuel injector connectors

sizes:
12-14-16-17-18-19 mm



1462CF/C6 1 014620006

260x145x60 mm - 1,2 kg

1462CF

single-ended bi-hex wrenches
for fuel injector connectors



mm	1	014620012
12	1	014620012
14	1	014620014
16	1	014620016
17	1	014620017
19	1	014620019
18	1	014620018

1462CF-SN/C6

set of 6 single-ended, articulated hexagon
wrenches for fuel injector connectors

sizes:
12-14-16-17-18-19



1462CF-SN/C6 1 014620026

275x182x64 mm

1462/KD

tool assortment for removing Denso injectors,
complete with hammer



1462/KD 1 014620060

335x210x80 mm - 4,8 kg

1462/KI

assortment of common rail diesel injector
pullers

Allows DELPHI-BOSCH-SIEMENS-DENSO injectors to be
removed



1462/KI 1 014620235

530x470x140 mm - 2,0 kg

1462/KMRC

tool assortment for removing injectors from Mercedes 2.1L, 2.2L, 3.0 V6 and Chrysler engines

For Bosch (2.1 and 2.2L) and Delphi (3.0) injectors injectors can be removed without removing engine.

Particularly suitable for following car models:
Mercedes Vito, Vario, CLK, Sprinter, Viano, M, GL, C, GLK, E, CLS, S, R, G Classes
Chrysler 300 C



1462/KMRC

1 014620070

310x300x118 mm - 3,5 kg

1462/KU

universal tool assortment for removing diesel common rail injectors

Complete with pliers and hammer



1462/KU

1 014620100

390x290x100 mm - 4,5 kg

1462AD/BSC

adapter for removing Bosch common rail injectors

For use with items Beta 960KI and Beta 1462/KU



1462AD/BSC

1 014620435

1462AD/SMN

adapter kit for removing Siemens and Denso injectors

For use with item Beta 960KI/1462KI



1462AD/SMN

1 014620436

1462/EI

universal vibration tool for injector removal

- Helps to fully remove jammed injectors from their housings, without damaging cylinder heads and without breaking injectors.
- Can be used with any injector removal set, with or without hammer face.
- Tool acts directly on removal tie rod, which is coupled with injector, through vibrations and pulses.
- Control valve allows vibration intensity to be adjusted to type of work to be carried out.

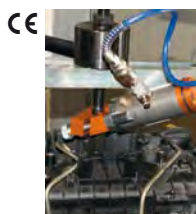

1462/EI

1 014620240

1462PIM

injector maintenance plates, pair

vice locking

sections:

Ø 11-12-13-14-16-19-20 mm



1462PIM

1 014620502

1463/KIT

valve timing system pulley locking kit



1463/KIT

1 014630001

280x140x75 mm - 1,2 kg

1464T

digital pressure and compression tester

SPECIFICATIONS

- 5" touch screen display
- rechargeable polymer lithium battery
- complete with 80 bar sensor (for low pressure) and USB cable



1464T

1 014640050

1464T/SP80

pressure sensor, 80 bars, for items 1464T and 960TP



1464T/SP80

1 014640053

960AD/TP2

set of adaptors for item 960TP in plastic case



960AD/TP2

1 009600510

430x310x50 mm - 3,2 kg

1464IC

complete set of dummy injectors and dummy glow plugs for item 1464T

Makes it possible to connect to the engine to check compression in diesel engines with digital tester 1464T.

Contents:

- 22 dummy glow plugs
- 5 dummy injectors
- 1 universal dummy injector kit for cars, trucks, marine engines and agricultural machines



1464IC 1 014640350

559x312x50 mm - 4,5 kg

1464IC/RK

universal dummy injector kit for cars, trucks, marine engines and agricultural machines

supplied with item 1464IC



1464IC/RK 1 014640377

200x110x30 mm - 885 g

1464AP

set for testing high pressure system in common rail diesel engines, with item 1464T

Complete with:
- high pressure pipe set
- fittings
- 2,000 bar sensor



1464AP 1 014640450

430x310x50 mm - 1,8 kg

1464AP T

high-pressure pipe
for items 1464AP and 960TAP



1464AP T12X12 1 014640453
1464AP T12X14 1 014640454
1464AP T14X12-M1,0 1 014640455

1464AP T16X12



1464AP T16X12 1 014640456

1464FG

set of dummy regulators
for testing diesel common rail system
(for use with Beta 1464T-1464AP)

Used with the tester and suitable adapters, it makes it possible to determine whether the problem is the high pressure pump or the regulator when there is no pressure in the high pressure circuit in common rail engines.
Recommended for Bosch, Delphi, Denso and Siemens pressure regulators



1464FG 1 014640470

350x250x80 mm - 1,8 kg

1464FG/CP4

dummy regulator for Bosch CP4 pump,
not supplied with item 1464FG



1464FG/CP4 1 014640475

1464APB

set for testing high pressure system in FSI petrol engines, for use with item 1464T

comes with 200 bar sensor and connectors



1464APB 1 014640500

240x210x50 mm - 0,5 kg

1464PB

set of 9 connectors for testing fuel low pressure
(for use with item 1464T)

Quick connectors to tester 1464T allow fuel low pressure in diesel and petrol engines to be quickly checked



1464PB 1 014640700

530x440x120 mm - 3,8 kg

1464ADB

set for testing AdBlue® system pressure for item 1464T

Supplied with adaptors for use with 80-bar standard sensor supplied with item 1464T



1464ADB 1 014640620

240x210x50 mm - 0,5 kg

 **Beta**
Quality Tools

1464FAP

set for testing diesel particulate filter (DPF) pressure
for item 1464T

Supplied with:
- 500 mbar sensor
- 8 mm adaptor with quick coupling and T fitting
- 3-m-long RJ45 cable



TECHNICAL DATA
Pressure test: 0÷500 mbar
Resolution: 1 mbar

1464FAP 1 014640610

240x210x50 mm - 0,5 kg

1464PT

set for testing turbo pressure,
for use with item 1464T

comes with sensor
and connecting cable



1464PT 1 014640550

240x210x50 mm - 380 g

1464TDI

set for testing pump pressure
in TDI engines,
for use with item 1464T

comes with connector



1464TDI 1 014640600

240x210x50 mm - 400 g

1464VD

vacuum testing set
for item 1464T

For measuring and storing maximum vacuum value
Supplied with:
- 800 mbar sensor
- 6 and 8 mm adaptors
- 3-m-long RJ45 cable

TECHNICAL DATA
Vacuum test: 0÷800 mbar
Resolution: 1 mbar
Maximum value storage



1464VD 1 014640570

240x210x50 mm

1464PF

set for testing pressure in braking system,
for use with item 1464T

comes with adaptors
and connectors



1464PF 1 014640650

400x280x60 mm - 3 kg



Beta

1465

engine efficiency tester

Allows endothermic engine compression to be tested within just a few seconds, without requiring connection to engine, taking power from vehicle battery, through a dedicated software

CE



Step 1: calculating engine rpm
Step 2: testing battery voltage trend during each revolution
Step 3: displaying absorbed power and compression calculated through starter operation for each piston
Step 4: testing battery charge and efficiency

TECHNICAL DATA
Operating voltage: 12V DC (vehicle battery)
Dimensions: 140x75x30 mm
Clamp cable length: 1300 mm
Weight: 215 g

1465 1 014650010

1466/C5

kit of 5 brake
bleeding wrenches

kit contents:
• 5 wrenches sizes 7-8-9-10-11 mm
• 1 drain hose with check valve



1466/C5 1 014660100

260x170x50 mm - 600 g

1466L 11

brake bleeding wrench, 11 mm,
long version



1466L 11 1 014660211

11 mm L 60 mm

1466TLF

brake oil recovery tank
capacity: 1.5 l

Quick coupler for bleeding pipe Ø 5.5 mm



1466TLF 1 014660201

1467

brake fluid extractor



Pressure: min 5 bar, max 11.5 bar

1467 1,5 1 014670001

1467/RK1

spare tube kit for item 1467



1467/RK1 1 014670501

1467/RK2

spare filler for item 1467



1467/RK2 1 014670502

1467LF/2

electric instrument for brake fluid replacement

with "pulsating effect" function



"Pulsating effect"

- Automatically stops when tank is empty, thereby preventing air from being let in
 - Maximum tank volume: 20 l
 - Operating pressure: 0.4÷3.5 bar
 - Power supply: 230V
- Supplied with:
- Brake oil recovery tank
 - 1 standard cap E20

1467LF/2 1 014670099

1467LF/RC

vessel with recovery tube for item 1467LF



1467LF RC 1 014670125

1467TU

plug for brake fluid tanks

- can be adapted to 90% of available tanks
- for use with Beta's item 1467LF



1467TU 1 014670090

1468N

valve depressors for disc removal

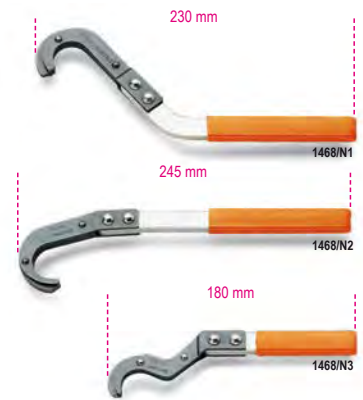

1468N/1	1 014680011
1468N/2	1 014680012
1468N/3	1 014680013

1470

drum brake spring pliers



L mm	
210	1 014700001
330	1 014700002
540	1 014700010

1470FT

drum brake shoe spring clamp pliers

40° angled noses
Easy access to awkward spaces



L mm	
184	1 014700000

1470PF

tool for replacing cylinders
in drum brakes

jaws remain open, for easy cylinder replacement



A mm	
25÷140	1 014700200

1471

drum brake spring pliers



L
mm
330
1 014710001

1471A

handbrake wire pliers



A max B
mm mm
45 5
2 014710010

1471GF

mouldable hooks for supporting brake calipers while replacing pads, pair



Max kg
5
1 014710310

1471M/C22

pneumatic tool for pushing back and rotating right and left disc brake pistons with accessories



1471M/C22
350x310x85 mm - 3,5 kg
1 014710101

1471M/50

pneumatic tool for pushing back and rotating right and left disc brake pistons with accessories

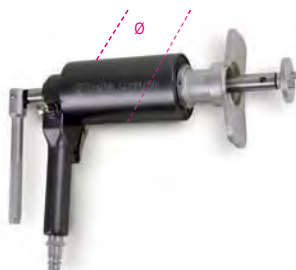

Ø
mm Kg Bar
50 150 5÷8
1 014710069

1471M/P

worn pad and TRW-Mégane caliper adapters



1471M/P
1 014710080

1471M/W50

VW Passat handbrake adapter (≥ 2005)

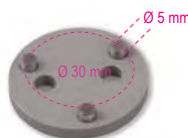

1471M/W50
1 014710079

1471PN/B1

Ford handbrake adapter

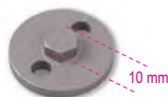

1471PN/B1
1 014710081

1471PN/B2

Daily handbrake adapter



1471PN/B2
1 014710082

1471PN/B3

BMW handbrake adapter



1471PN/B3
1 014710083

1471PN/B4

BMW handbrake adapter



1471PN/B4
1 014710084

1471PN/B5

Mini/ BMW handbrake adapter



1471PN/B5
1 014710085

1471CF

pentagon hand sockets for brake caliper nuts



mm
14 1 014710314
19 1 014710319

1471CM

pentagon socket driver for brake caliper screws



mm
10 1 014710360

1471CM/E11

hexagon socket driver, 11 mm, for Mercedes ML brake caliper screws (series 166)



mm	∅ mm	L mm	L1 mm	
11	24	75	15,5	1 014710361

1471D2

tool for pushing back front disc brake pistons, with closed callipers

Two pairs of plates for working on 2 and 4 piston callipers



∅ mm				
10				1 014710301

250x170x60 mm 1,5 kg

1472

hose clamp pliers



1472	1 014720001
------	-------------

1472AU

automatic hose clamp pliers



∅ mm				
18÷53				1 014720100

1472R/AU

spare tips for pliers 1472AU



1472AU/R	1 014720101
----------	-------------

1472AU/P

automatic hose ring pliers with extension



∅ mm	L mm			
18÷54	630			1 014720105

1472AU/RP

spare cable for pliers 1472AU/P



1472AU/RP	1 014720106
-----------	-------------

1472FC

Clic® collar pliers with swivel heads



1472FC	1 014720090
--------	-------------

1472FC/GE

heavy-duty Clic® collar pliers

particularly suitable for large-size clippers



L mm				
230				1 014720093

1472FC/L

Clic® collar pliers with flexible extension



L mm				
630				1 014720095

1472FCL/RP

spare cable for pliers 1472FC/L



1472FCL/RP	1 014720096
------------	-------------

1472FCA

collar removal pliers with Visa® type rack



1472FCA	1 014720041
---------	-------------

1472H

Henn clamp removal tool



L mm				
100				1 014720000

1472MT/VW

pair of claws for disconnecting suction manifolds in VAG cars

Can be used on turbocharged petrol engines 1.0 - 1.2 - 1.4



1472MT/VW	1 014720500
-----------	-------------

1472TM

quick coupler pliers for multijet filters



1472TM 1 014720200

1472VW

hose clamp pliers, with swivel heads For Volkswagen and Mercedes cars



1472VW 1 014720051

1473

OETIKER® collar pliers



1473 275 1 014730001

1473A

slotholder pliers for OETIKER® collars



1473A 1 014730010

1473Q

OETIKER® collar pliers with drive

For use with:
• torque wrenches
• ratchets
• male drives



1473Q 1 014730005

1473P

clamp pliers for OETIKER® low-profile collars



1473P A Max mm 53 1 014730020

1473FN

tool for tightening and cutting strap ties made of stainless steel

For use with Panduit® ties and the like



1473FN A mm 4,7÷9,5 1 014730501

1473T

steel collar cutting nippers

allows collars to be cut without risking damaging guards, sleeves etc.



1473T A Max mm 14 L mm 220 1 014730582

1474/C4

kit of 4 tools for removing Volkswagen spark plug coils



1474/C4 1 014740100

290x190x50 mm - 1 kg

1474E/VW

expansion puller for ignition coils, Volkswagen group



1474E/VW 1 014740120

1474E/VW2

ignition coil puller, for VAG group vehicles for use on engines 1.0 - 1.2 - 1.4 - 2.0



1474E/VW2 1 014740150

1474L

spark-plug pliers, curved long nose, 15°

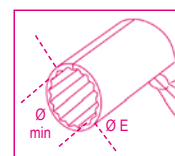

1474L Ø min mm 14 Ø E mm 20 2 014740010



1474DL

spark-plug pliers, long nose,
double layer PVC coated handles

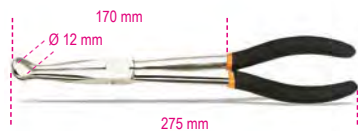

1474DL 1 014740015

1474G

curved long nose pliers
for removing glow plug caps



1474G 1 014740200

1475U

combination pliers,
bright chrome-plated,
double layer PVC coated gun handles



1475U 1 014750010

1476

adjustable self-locking pliers
for exhaust pipe cutting



Ø min mm 19 Ø max mm 75 L mm 225 1 014760002

1476/RC

spare chain for item 1476



1476/RC 1 014760012

1476A

pliers for exhaust pipe cutting



Ø min mm 30 Ø max mm 95 1 014760005

1476A/RC

spare chain for item 1476A



1476A/RC 1 014760015

1476C/1

exhaust pipe expanders



1476C/1 1 014760101
Ø 30=42 mm
L = 131 mm
L1 = 51 mm

1476GT

pliers for removing rubber supports
from exhaust pipes



L mm 280 A Max mm 58 3 mm 1 014760050

1476PSA

exhaust collar pliers
with pin, PSA group
Nose shape and automatic rack locking
make it possible to work
without pulling out pin



L mm 309 A Max mm 60 S mm 12,2 1 014760060

1476T

wrench for removing/installing turbines
on Volkswagen Audi diesel engines



mm 12 1 014760200

1477/C10

bent wrench with 9 bits
for belt tightening nuts

1 bent wrench with bit drive
4 double bi-hex bits: 12x14 - 13x15 - 16x17 - 18x19 mm
5 bits for Torx(R) head screws: E10 - E12 - E14 - E16 - E18



1477/C10 1 014770310
530x110x55 mm

1477D

ring wrenches for belt tightening nuts



mm 13 1 014770113
15 1 014770115
16 1 014770116
17 1 014770117
19 1 014770119

1477D/S5

set of 5 ring wrenches for belt tightening nuts



1477D/S5 1 014770200
13-15-16-17-19 mm
600x200x70 mm - 2,2 kg

1477K/7

kit with bent reversible ratcheting wrench and bits



- 2 TORX T40-T45 bits
- 1 XZN 10 bit
- 1 hexagon bit, 8 mm
- 3 bi-hex bits, 10-12-13 mm

1477K/7 L
mm 250 1 014770051

1478

pin removing pliers



1478 1 014780001

1478T

plastic pin removable pliers with swivel head and pressure clips

Head can be rotated 90°



1478T S
mm 4,5 1 014780101

1478/3P

plastic pin removal pliers with 3 release points



1478/3P 1 014780151

1479

trim pin remover



1479 2 014790001

1479/B27

kit of 27 nylon tools for removing pins and working on plastics and seals, hangle



1479/B27 1 014790407

1479LB/C5

kit of 5 metal trim pin removers



1479LB/C5 1 014790150

215x165x50 mm

1479L/S2

multipurpose wrecking bars, pair, made of Teflon®



1479L/S2 1 014790510

1479LV/S3

kit of 3 multipurpose wrecking bars, made of metal

sizes:
1479LV/1: 10x12 mm
1479LV/2: 4.8x9.6 mm
1479LV/3: 2.8x6 mm



1479LV/S3 1 014790100

1479ML/B17

kit of 17 multipurpose wrecking bars, made of plastic particularly recommended for precision jobs



1479ML/B17 1 014790700

1479ML/S3

kit of 3 multipurpose wrecking bars, made of plastic

Particularly recommended for precision jobs



1479ML/S3 1 014790603

1479N/S5

kit of 5 nylon trim pin removers



1479N/S5 1 014790251

1479RB/1

straight putty knife scraper



1479RB/1 1 014790315

1479RB/2

bent putty knife scraper



1479RB/2 1 014790320

1479RB/3

flat putty knife scraper



1479RB/3 1 014790310

1479U/13

putty knife scrapers



1479U/13 2 014790010

1479U/32

trim pin remover, stainless steel blade



1479U/32 2 014790015

1480

Kit for filling diesel oil filters of cars without electric pumps

• Also for use with tyre inflators

Kit contents:

- GM quick couplings
- Renault, GM, Fiat quick couplings, inside Ø 6 mm
- Renault, GM, Fiat quick couplings, inside Ø 7 mm
- Ford quick couplings
- PSA quick couplings, inside Ø 6 mm
- PSA quick couplings, inside Ø 7 mm
- Ford quick couplings
- 2 cone-shaped adapters for cars without quick couplings



1480 1 014800010

410x320x70 mm

1481/C12

Kit of 6 pairs of hose pliers

Kit contents:

- 2 different pairs of pliers size 1/4"
- 2 different pairs of pliers size 3/8"
- 2 different pairs of pliers size 5/16"
- 3 pairs of rubber caps



1481/C12 1 014810312

370x270x59 mm

1481K/S4

kit of 4 self-locking terminals for line obstruction

sizes: 5/16" - 3/8" - 1/2" and loop



1481K/S4 1 014810400

1481PL/A

plastic hose pliers



	Ø mm	
1481PL/A	8÷15	3 014810110
1481PL/B	15÷25	3 014810120
1481PL/C	25÷45	3 014810130

1481PL/S3

set of 3 plastic hose pliers



1481PL/S3 1 014810200

1481PL-A Ø 8÷15 mm
1481PL-B Ø 15÷25 mm
1481PL-C Ø 25÷45 mm

1482

adjustable self-locking wrench for tank floating ring nuts



	Ø mm	
89÷170		1 014820001
89÷200		1 014820002



1482A/1

3-leg wrench for floating ring nuts, tank with aluminium ring nut

For operating on aluminium ring nut installed on Fiat, Volkswagen, Opel, Chevrolet, Mercedes and BMW cars since 2011



∅ mm 185 1 014820005

1482A/3

wrench for tank floating ring nuts, PSA group

So designed as to make it possible to operate on decentralized axis by removing ring nut, without damaging delicate fuel line



∅ mm 157 1 014820007

1482A/5

wrench for tank floating ring nuts, 22 sectors

for use on plastic ring nuts in VAG group cars



∅ mm 180 1 014820015

1482/8 - 1482/10

quick coupler pliers for fuel pipes



∅ mm			
1482/8	8	2	014820008
1482/10	10	2	014820010

1482B

quick coupler pliers for fuel pipes



1482B 1 014820021

1482C

wedges (2 pairs) for releasing diesel fuel filter fittings, Fiat, Volkswagen, Jeep, Chrysler and Volvo groups

Quick filter replacement without irreparably damaging fittings



1482C 1 014820022

1482D

quick coupler pliers for fuel pipes, with flexible extension



1482D 1 014820026

1483K/12

kit for removing valves from air-conditioning system with set of five-star head bits

Kit contents:
 • 2 female octagon sockets, ∅ 12 and 15 mm, for high-pressure valves
 • 2 male open end sockets, section 2.2 and 3.2 mm, for throttle valves
 • 1 set of five-star head bits: PT10, PT15, PT20, PT25, PT27, PT30, PT40



1483K/12 1 014830012
 120x80x35 mm

1483KV-PT/S7

set of five-star head bits

Included sizes:
 PT10 - PT15 - PT20 - PT25 - PT27 - PT30 - PT40



1483KV PT/S7 1 014830117

1483K/22

kit for separating couplers on air-conditioning, fuel supply and lubrication systems



1483K/22 1 014830022
 300x230x55 mm - 1 kg

1484

set of 2 tools for removing and installing stretch belts

Allows stretch belt to be quickly removed and correctly installed, without risking damaging it



1484 1 014840010

1484PSA

tool for installing water pump stretch belt without belt tightener

for use for PSA and Opel group vehicles engines 1.0 - 1.2



1484PSA 1 014840012

1485BP

half-moon tool for locking toothed pulleys

can be adjusted through swivel handle, tightens and locks pulley from outside, preventing neighbouring sensors from getting damaged



A Max mm 130 1 014850000

1485BPM

half-moon tool with aluminium jaws for locking multi-groove pulleys

can be adjusted through swivel handle; tightens and locks pulley from outside, preventing neighbouring sensors from getting damaged



A Max mm 180 1 014850002

1485FCA/K2

tools for pre-loading timing belt bearings, pair, FCA group recommended for 1.2, 1.4 8/16 V and 1.4 Multiair engines

- 1 175-mm-long tool with 13.5-mm-deep push rods
- 1 305-mm-long articulated tool with 13.5-mm-deep push rods



1485FCA/K2 1 014850220

1485FCA/T

timing belt tensioner, long series, with 13.5 mm inserts



L mm 175 P mm 13,3 1 014850210

1485FCA/TS

timing belt tensioner, articulated, with 13.5 mm inserts



L mm 305 P mm 13,5 1 014850215

1485FRD/T

tensioning lever for service belts mounted on Ford engines can be used to remove alternator pulleys



L mm 450 Q mm 12,80 1 014850310

1485MRC/T

tensioning lever for service belts mounted on Mercedes engines for use with M133 - M270 engines



L mm 510 Ø T55 1 014850315

1485VLV/T

tensioning lever for service belts mounted on Volvo engines

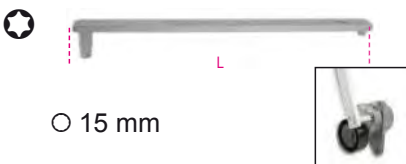

L mm 420 Ø T50-T60 15 1 014850320

1485TC

tensioning lever for service belts, mounted on Ford, PSA, FCA engines



L mm 475 1 014850330

1485/KIT

kit for controlling cam belt tension



1485/KIT 1 014850100
230x140x75 mm - 580 g

1485MJ

camshaft locking tool, for 1.3 16V Multijet engines

2 3-form heads for working on all 1.3 16V Multijet engines of FCA, Opel, Ford and Suzuki group vehicles



1485MJ L mm 500 1 014850150

1485PMTJ

driving shaft pulley release lever for Multijet engines so designed as to lock driving shaft while removing pulley



L mm 450 1 014850190

1485R

universal tool for rotating camshaft pulleys
made from forged steel
with 2 pairs of tips



Ø	Ø1	L	
30÷120	10 - 17	500	1 014850025

1485R/P10

pairs of inserts



1485R/P10	1 014850035
-----------	-------------

1485R/P17

pairs of inserts



1485R/P17	1 014850038
-----------	-------------

1485VAG/K2

tools for pre-loading
timing belt bearings, pair

- 3-position swivel head
- 1 tool with 12.5-mm-deep head
- 1 tool with 21.5-mm-deep head



1485VAG/K2	1 014850080
------------	-------------

1485VAG

tools for pre-loading
timing belt bearings

- 3-position swivel head



	L	P	
	mm	mm	
1485VAG/12,5	190	12,5	1 014850062
1485VAG/21,5	195	21,5	1 014850071

1486/10

wrench for natural gas cylinder valves

- VW group cars since 2008
- Panda from 2004 to 2012
- Grande Punto from 2005 to 2012
- Ducato since 2010
- new Doblò and Combo
- Cubo and Fiorino



36 mm

1486/10	1 014860110
---------	-------------

1486/20

wrench for natural gas cylinder valves

- Multipla
- Ducato 1st and 2nd series until 2010
- Berlingo and Ranch
- C3 with iron cylinders
- Punto from 1999 to 2010
- Doblò 1st series
- Daily and Iveco group
- Dr5

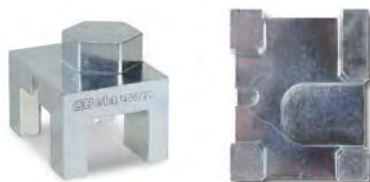

36 mm

1486/20	1 014860120
---------	-------------

1486/30

wrench for natural gas cylinder valves

- Zafira 2nd series
- Combo 1st series

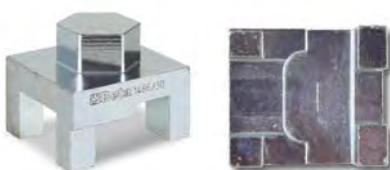

36 mm

1486/30	1 014860130
---------	-------------

1486/40

wrench for natural gas cylinder valves

- Touran 1st series

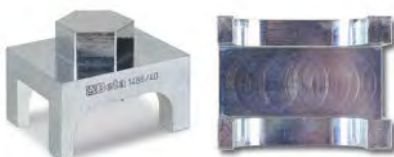

36 mm

1486/40	1 014860140
---------	-------------

1486/50

wrench for natural gas cylinder valves

- Panda since 2012
- New Ypsilon



36 mm

1486/50	1 014860150
---------	-------------

1486/60

wrench for natural gas cylinder valves

- C4 Picasso
- BRC systems



36 mm

1486/60	1 014860160
---------	-------------

1486/70

wrenches for natural gas cylinder valves, pair

- C3 with composite cylinders



36 mm

1486/70	1 014860170
---------	-------------

1486/80

wrench for natural gas cylinder valves

- B-Class
- Zafira 3rd series



36 mm

1486/80	1 014860180
---------	-------------

1486/90

wrench for natural gas cylinder valves

- Zafira 1st series
- Kangoo 1st series
- Sprinter

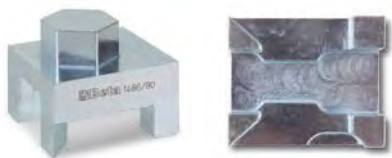

□ 36 mm

1486/90 1 014860190

1488 - 1488L

oil-filter wrench with double chain

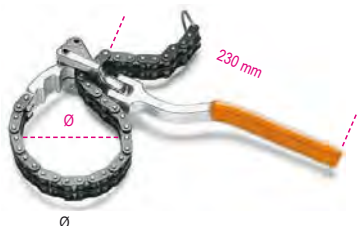

1488	60÷110	1	014880001
1488L	60÷160	1	014880050

1488/1

oil-filter wrench with thin double chain



1488	60÷110	1	014880010
------	--------	---	-----------

1488R...

spare chain



1488RC	1488	350	1	014880101
1488R/L	1488/L	520	1	014880150
1488RC/1	1488/1		1	014880110

1489/31T

alternator pulley free wheel wrench



T50	15	31	1	014890016
-----	----	----	---	-----------

1489/33

alternator pulley free wheel wrench



1489/33	33	1	014890010
---------	----	---	-----------

1489/33P

alternator pulley free wheel wrench, for new Bosch FIAT Grande Punto alternators



M	mm	31	1	014890015
10	15			

1489/E

alternator pulley free wheel wrench



mm	mm	1	014890025
10	15		

1489R

alternator pulley free wheel wrench



1489/R	1	014890020
--------	---	-----------

1489/Y

alternator pulley free wheel wrench, for Nippondenso alternators



mm	1	014890040
32		

1489/C14

assortment of 14 tools for free alternator pulleys



1489/C14	1	014890100
----------	---	-----------

- 867PE 8 mm
- 867PE/L 8 mm
- 867XZN/L M10
- 867TX/L T50
- 867/2 □1/2"
- 920B 10 mm
- 1489/33
- 1489/33P M10
- 1489R
- 1489/Y
- 1489/31T T50
- 1489/E 10 mm
- 188 10 mm
- 188 15 mm

420x250x45 mm - 1,9 kg

1490

strap wrenches for oil filters

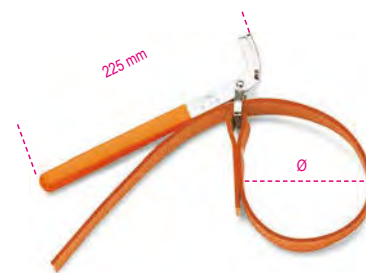

1490/1	160	1	014900001
1490/2	240	1	014900002

1490/R1 - 1490/R2

spare fabric straps for item 1490



1490/R1	160	1	014900101
1490/R2	240	1	014900102

1490F

strap wrenches for filters

38"

12"



Ø Max
mm
200

1 014900201

1491

adjustable oil filter wrench



Ø
mm
65÷110

2 014910001

1491R

spare metal band for item 1491



1491R

10 014910010

1491A

adjustable oil filter pliers

Precision adjustment through rack



L Ø min - Max
mm mm

345 55 ÷ 140

1 014910040

1491T

adjustable truck oil filter pliers

Precision adjustment through rack
For use with drier filters



L Ø min - Max
mm mm

500 70 ÷ 200

1 014910050

1492/1 - 1492/2

adjustable oil filter wrenches



	Ø mm		
1492/1	60÷80	1	014920001
1492/2	80÷110	1	014920002

1492T

drier filter wrenches

12"



	Ø mm	H mm	
1492T 40	125÷145	40	1 014920540
1492T 75	120÷140	75	1 014920575

1493B

bi-hex wrenches
for hard-to-reach oil filter cartridges

38"



mm	± mm	
24	8	1 014930524
27	8	1 014930527
32	8	1 014930532
36	8	1 014930536
38	8	1 014930538

1493B/S5

set of 5 bi-hex wrenches
for hard-to-reach oil filter cartridges

sizes:
24-27-32-36-38 mm

38"



1493B/S5 1 014930599

1493

oil filter wrench

12"



Ø mm	N	
65	14	1 014930200
68	14	1 014930206
73	14	1 014930208
74	14	1 014930209
74	15	1 014930210
75-77	15	1 014930212
76	8	1 014930214
76	14	1 014930218
76-74	15	1 014930220
78	15	1 014930224
80	15	1 014930226
82-80	15	1 014930228
86	16	1 014930230
90	15	1 014930234
92	10	1 014930236
93	15	1 014930238
95	15	1 014930244
100	15	1 014930248
106	15	1 014930250
108	15	1 014930252
135	18	1 014930256

1493/PF

Purflux® oil-filter wrenches

12"



Ø mm	N	
66	6	1 014930202
76	12	1 014930216
76	30	1 014930222
86	18	1 014930232
93	36	1 014930240
93	45	1 014930242
96	18	1 014930246
108	18	1 014930254



1493/C30

set of 28 oil filter wrenches

12"



Sizes included in kit (Ø mm / n°. of sides)

1493:
65/14 - 67/14 - 68/14 - 73/14 - 74/15
76/15 - 75.77/15 - 76/14 - 76/8 - 78/15 - 80/15
82/15 - 86/16 - 90/15 - 92/10 - 93/15 - 95/15
100/15 - 106/15 - 108/15

1493PF (Purflux)

66/6 - 76/12 - 76/30 - 86/18
93/36 - 93/45 - 96/18 - 108/18

- Includes 1 adjustable oil filter wrench
Ø 65+120 mm

1493/C30 1 014930000

530x400x110 mm - 4 kg

1493AL

oil filter wrenches

N= number of sides

38"

12"

38"



Ø mm	N	•	□	
64	14	27	1/2"	1 014930310
66,5	14	27	1/2"	1 014930315
74	14	27	1/2"	1 014930320
79	15	27	3/8"	1 014930325
84	14	27	3/8"	1 014930330
87	16	27	1/2"	1 014930335
92	15	27	3/8"	1 014930340
94,5	15	27	3/8"	1 014930345
100,5	15	27	3/8"	1 014930350

1493AL 4S

oil filter wrenches

for Asian cars

4-hook profile

38"

38"

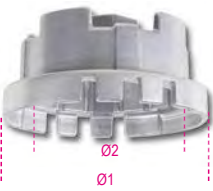

Ø1 mm	Ø2 mm		
70	64,5	27	1 014930304
80	64,5	27	1 014930305

1493AL CF

hexagon socket wrenches
for oil filter cartridges

12"

H

38"

Ø mm	H mm	•	
24	34	27	1 014930424
27	34	27	1 014930427
30	34	27	1 014930430
32,5	34	27	1 014930432
36	34	27	1 014930436
38	34	27	1 014930438

1493/C19

set of 18 oil filter wrenches,
particularly suitable for Asian cars

Ø mm N°. of sides

63-64 14
66.5 14
74 14
79 15
84 14
87 16
92 15
94.5 15
100.5 15
64.5 14 hook wrench for Toyota cars
64.5 14 hook wrench for Lexus cars
6 hexagon sockets, sizes 24-27-30-32.5-36-38 mm, for filter cartridges
Kit includes 1 universal adjustable wrench Ø 58+93 mm

12"

38"



1493/C19 1 014930019

490x450x60 mm - 4 kg

1493DSG

wrench for removing/installing
DSG oil filter

12"

12"



Ø mm 24 1 014930800

1493FF

wrench for removing/installing plastic seats of
Ford Peugeot Citroën oil filters
engines: TDCi-HDi

Allows plastic seat to be correctly tightened
at 25 Nm by means of a torque wrench

12"

12"

12"

12"

12"

12"

12"

12"

12"

12"

12"

12"

12"

12"

12"

12"

12"

12"

12"

12"

12"

12"

12"

12"

12"

12"

12"

12"

12"

12"

12"

12"

12"

12"

12"

12"

12"

12"

12"

12"

12"

12"

12"

12"

12"

12"



Ø mm 27 1 014930127

1493FT

wrench for Ford Transit Diesel oil filters

Can be used for all
Transit, Transit Custom and Tourneo Custom versions
manufactured since 2012

12"

12"

12"

12"

12"

12"

12"

12"

12"

12"

12"

12"

12"

12"

12"

12"

12"

12"

12"

12"

12"

12"

12"

12"

12"

12"

12"

12"

12"

12"

12"

12"

12"

12"



Ø mm 115 1 014930085

1493J

wrench for MultiJet

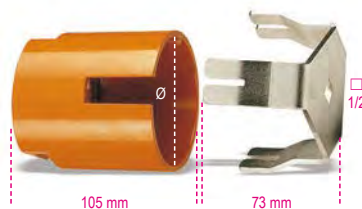

Ø mm 90 1 014930080

1493VW

diesel oil filter wrench,
for VAG and Volvo cars

12"

12"

12"

12"

12"

12"

12"

12"

12"

12"

12"



Ø mm 82,5 1 014930086

1493/C7

self-adjusting oil filter wrench with three arms for right- and left-hand tightening, with interchangeable arms

antislip diamond finish
2 sets of arms:

- 1 set with 20 mm working length
- 1 set with 38 mm working length



	∅ mm	∅ mm		
1493/C7	50÷100	16	1	014930079

210x150x50 mm

1493H

self-adjusting oil filter wrench with 3 arms, for right and left hand tightening

Knurled jaws

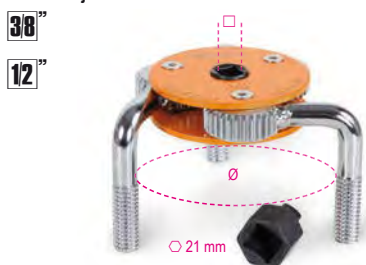

	∅ mm		
1493H	72÷127	1	014930077

1493/S-U

self-adjusting oil filter wrench with 3 arms, for right and left hand tightening



	∅ mm		
1493/S	3/8-1/2 80-115	1	014930074
1493/U	1/2 105-165	1	014930076

1493X

self-locking oil filter wrenches, for left-hand tightening



	∅ mm	± mm		
1493X/1	60÷80	2,9	1	014930105
1493X/2	80÷98	2,9	1	014930110

1493Y

self-locking oil filter wrenches, for right- and left-hand tightening, heavy-duty version

item 1493Y/2 can also be used for drier filters



	∅ mm	± mm		
1493Y/1	80÷110	7,3	1	014930120
1493Y/2	104÷145	7,3	1	014930122

1494

square oil drain plug socket



	mm		
1494	10	1	014940280

1494BMW

special socket for plastic oil drain plugs, for BMW engines

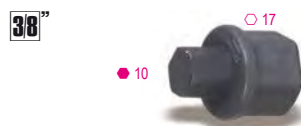

1494BMW	10	1	014940315

1494FPC

special socket for plastic oil drain plugs, for Ford, Peugeot and Citroën engines



1494FPC	17	1	014940320

1494E

male hexagon oil drain plug sockets



	mm		
1494E	8	1	014940208
1494E	9	1	014940209
1494E	10	1	014940210
1494E	11	1	014940211
1494E	12	1	014940212
1494E	14	1	014940214
1494E	17	1	014940217

1494Q

male square oil drain plug sockets



	mm		
1494Q	8	1	014940258
1494Q	9,5	1	014940259
1494Q	12	1	014940262
1494Q	13	1	014940263

1494T

male triangular oil drain plug socket



	mm		
1494T	9,5	1	014940289

1494XZN

male oil drain plug socket with XZN® profile



	M		
1494XZN	16	1	014940296

1494VW

special socket for plastic oil drain plugs, Volkswagen engines

Allows plastic plug to be removed and installed from oil sump.
Specially designed for Volkswagen cars with TFSI and TDI engines



1494VW	10 mm	1	014940305

1494VW/K

engine oil replacement kit,
for VAG cars



- Kit contents:
- 1 special socket for plastic oil drain plugs
 - 6 plastic oil sump plugs

1494VW/K 1 014940310

1494/C14A

assortment of 14 oil change tools



1494/C14A 1 014940150

- 1494E 8-9-10-11-12-14-17
- 1494Q 8-9,5(3/8")-12-13
- 1494 10
- △ 1494T 9,5(3/8")
- 1494XZN M16

380x305x40 mm - 1,7 kg

1494M

tool for hexagon oil drain plugs,
magnetic, flexible

Allows plug to be unscrewed without risking
getting burnt or dirty

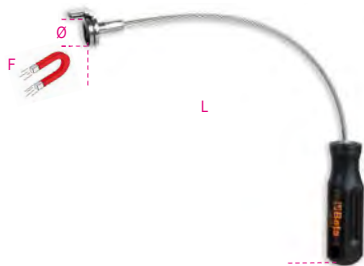

L mm 293
F kg 2,5
Ø mm 19
1 014940401

1495/C6

assortment of tools for repairing oil sump
threads



- Damaged thread is removed by screw tap and enlarged by one size
 - Allows repairs and avoids replacing oil sump
- Contents:
- 1 screw tap M13x1.25 + 6 screws + 12 washers
 - 1 screw tap M13x1.5 + 6 screws + 12 washers
 - 1 screw tap M15x1.5 + 6 screws + 12 washers
 - 1 screw tap M17x1.5 + 6 screws + 12 washers
 - 1 screw tap M20x1.5 + 6 screws + 12 washers
 - 1 screw tap M22x1.5 + 6 screws + 12 washers

1495/C6 1 014950500

420x185x60 mm - 2,1 kg

1495M

screw tap for oil drain plug threads



M	
13x1,25	1 014950553
13x1,50	1 014950563
15x1,50	1 014950565
17x1,50	1 014950567
20x1,50	1 014950570
22x1,50	1 014950572

1495T

kit with 6 oil drain plugs and washers



M	
13x1,25	1 014950503
13x1,50	1 014950513
15x1,50	1 014950515
17x1,50	1 014950517
20x1,50	1 014950520
22x1,50	1 014950522

1496/C

oil plug wrench



8 x 10 mm 3 014960010

1497CEL

tool for removing electrical connectors from
VAG group vehicles

allows connectors to be quickly disconnected, without getting
damaged.



1497CEL 1 014970170

1497D

relay removal pliers, straight pattern



A min+Max mm 15÷50
1 014970150

1497P

relay removal pliers, bent pattern, 60°



A min+Max mm 15÷50
1 014970160

1497/C23

assortment of 23 tools for releasing electrical connectors



1497/C23

1 014970200

440x250x70 mm - 1,7 kg

1497/C94

assortment of 94 car testing connectors for use with main diagnostic tools

- 2 t-taps
- 2 potentiometers
- 2 warning lights
- 2 SRS connectors
- 2 alligator clips
- 2 acicular probes
- 2 prods
- 2 dual banana connectors
- 4 single banana connectors
- 24 flat male terminals 0.6÷6 mm
- 12 round male terminals 1.6÷3.9 mm
- 24 flat female terminals 0.6÷6 mm
- 12 round female terminals 1.6÷3.9 mm



1497/C94

1 014970300

430x390x100 mm - 3 kg

1497RC

t-taps, pair

- cable section: 1.5÷3.5 mm
- voltage: 0÷330V
- max. current: 5A



1497RC

1 014970351

1497KB/S3

3 tool kit for removing Knorr and Bremse electrical connectors

- 1 tool for bayonet connectors
- 1 single head tool for 2-pole connectors
- 1 double head tool for 4- or 6- and 12-pole connectors



1497KB/S3

1 014970050

1497/S3

set of 3 cables for electrical signal detection

- 1 straight pc.
- 1 45° pc.
- 1 90° pc.



1497/S3

1 014970400

1498

voltage tester

CE



3÷48V

2 014980100

1498MN/12

multipurpose portable starter

- Motor vehicle starting with 12-volt battery (diesel and petrol engines up to 2,000 cc)
- Charging of tablets, mobile phones and electronic devices in general
- Multi-use LED torch



STANDARD ACCESSORIES

- lithium-cobalt battery
- starting cables with insulated clamps and device protecting against polarity reversal and short circuits
- USB outlet for charging electronic devices
- digital display and battery charge indicator
- USB cable with charge adapters
- mains and car power supplier

TECHNICAL DATA

- Pickup current: 600A
- Battery type: LiCoO2
- Starting output: 12 volts

1498MN/12

1 014980000

1498MN/12-C

booster cable with clamps for item 1498MN/12



1498MN/12-C

1 014980005

1498MN/12-R

mains power supplies for mini starter LT/12-R



1498MN/12-R

1 014980003

1498MN/12-P

car socket power supply for mini starters LT/12-P



1498MN/12-P

1 014980004

Beta

1498MN/12-U

USB cables with universal U adapters



1498MN/12-U 1 014980009

1498LT/12

portable high-performance starter, ultralightweight



CE

The microprocessor provides full protection against:

- polarity reversal
- short circuits
- incorrect voltage
- overloads
- underdischarge
- overcharge
- overtemperature

TECHNICAL DATA

Operating voltage: 12 V
 Continuous amperage: 800 A
 Maximum pickup amperage: 2000 A
 Peak amperage: 4000 A
 Cable length: 500 mm
 Battery type: 4-cell LifePo4
 Memory saving function: YES
 Dimensions: 260 x 135 x 72 mm
 Net weight: 2.5 kg
 Complete with charging power supply 12 V 1.3A

1498LT/12 1 014980012

1498LT/12-SF

wall fixing bracket for starter 1498LT/12



1498LT/12-SF 1 014980013

1498LT/12-R7

mains power supply for starter 1498LT/12



1498LT/12-R7 1 014980657

1498/12

Portable car starter, 12V



CE

TECHNICAL DATA:

- Pickup current: 2200A
- Shoulder strap included
- Sealed lead acid battery, solid electrolyte (AGM) type

1498/12 1 014980480

13 kg

1498/24

portable car and commercial vehicle starter, 12-24V



CE

TECHNICAL DATA:

- Pickup current: 4200A (12V) - 2100A (24V)
- Shoulder strap included
- Sealed lead acid battery, solid electrolyte (AGM) type

1498/24 1 014980490

17 kg

1498B12/R02

12V spare battery for starters 12-24V



genesis EP
PURELY REAL

1498B12/R02 1 014980502

1498/12-24 R20

mains power supply for starters items 1498/12 and 1498/24



1498/12-24 R20 1 014980520

1498C/24

wheeled starter, 24V



CE

- Wheeled frame for easier movements and minimized effort
- Outstanding performance for numerous starts, including particularly demanding ones
- Electronic battery charger included
- LED and sound alarms in case of polarity reversal
- Protection against voltage peaks
- Battery charge indicator
- Solid electrolyte lead-acid battery (AGM)

Continuous amperage	1700 A
Operating voltage	24 V
Pickup amperage	4000 A
Cable length	2000 mm
Cable section	70 mm
Charging voltage	230 V
Automatic battery charger	24 V - 10 A

1498C/24 1 014980244



1498/2A

electronic motorcycle battery charger, 12V

allows charging of all
Pb Wet, Agm, Gel, Mf and Vrla battery types
and LiFePo4 lithium batteries



- Two different types of charge, for lithium and lead acid batteries respectively
- Automatic multi-stage charge cycle
- Reverse polarity and short-circuit protection
- IP65 degree of protection
- Complete with cable with clamps and cable with eyelets
- Power supply voltage: 220-240V

TECHNICAL DATA

- Charging current: 1A
- Charging capacity: 2Ah-40Ah
- Frequency: 50-60 Hz
- Battery voltage: 12V
- Dimensions: 180x80x40 mm
- Weight: 0.5 kg

1498/2A 1 014980102

1498/4A

Electronic car/motorcycle battery charger, 6-12V



- Protected against polarity reversal and short circuits
- Automatic 6 V or 12 V selection
- Automatic battery type selection
- Digital backlit display
- Pull-back fixing hook

TECHNICAL DATA

- Power supply voltage: 220V-240V
- Frequency: 50-60 Hz
- Rated current (min-max): 1-4 Amp
- Battery voltage: 6V/12V
- Battery capacity: 4Ah-80Ah
- Charging time: 12 hours
- Degree of protection: IP65

1498/4A 1 014980104

1498SA/2A-4A

cable with cigarette lighter plug
for items 1498/2A and 1498/4A



1498SA/2A-4A 1 014980120

1498/8A

Electronic car / commercial vehicle battery
charger, 12 V



- Slow and quick charge (2A-8A)
- Flat battery recovery function
- Power supply function 13.8V-5A
- Protected against polarity reversal and short circuits
- Manual battery type selection
- Digital backlit display
- Pull-back fixing hook

TECHNICAL DATA

- Power supply voltage: 220V - 240V
- Frequency: 50-60 Hz
- Rated current (min-max): 2-8 Amp
- Battery voltage: 12V
- Battery capacity: 5Ah-160Ah
- Memory saving feature: 13,8V - 5A
- Degree of protection: IP65

1498/8A 1 014980108

1498/4A-8A CO

eyelet cable for items 1498/4A and 8A



1498/4A-8A-CO 1 014980114

1498/4A-8A CP

cable with clamps for items 1498/4A and 8A



1498/4A-8A-CP 1 014980118

1498/2A-8A-PR

extension for item 1498/2A/4A/8A



1498/2A-8A-PR 1 014980119

1498/16A

electronic multipurpose battery charger, 12-24V



- backlit graphic display
- max. charging current: 16A, continuous
- charging and charge maintenance
- protected against polarity reversal and short circuits
- 9 charging steps
- floating system
- SHOW ROOM function (13.8V - 12A)
- SUPPLY function (14V - 12A)
- memory saving function (13.8V - 12A)
- battery recovery function
- clamp holder
- reclining hook fastening
- supplied accessories: cable with clamp, cable with eyelets

TECHNICAL DATA

- Power supply: 220-240V
- Power: 240W
- Charging current: 4-16A
- Battery types: Agm - Wet - Lithium (LiFePo4)
- Charging capacity: 5-360Ah
- Maintenance capacity: 5-550Ah
- Output voltage: 12-24V
- Minimum battery voltage: 0.8V
- Degree of protection: IP20

1498/16A 1 014980126



1498/30A

electronic multipurpose battery charger,
6-12-24V

Allows batteries to be charged
and powers motor vehicles during diagnostic operations



- maximum continuous charging current: 30A
- charging and maintenance
- battery recovery
- reprogramming and power supply
- protected against polarity reversal, short circuits, incorrect voltage and overload

TECHNICAL DATA

Power supply: 220-240V
 Power: 500W
 Charging current: 5-30A
 Battery types: Agm - Wet - Lithium (LiFePo4)
 Charging capacity: 5-300Ah
 Maintenance capacity: 5-900Ah
 Output voltage: 6-12-24 Volt

1498/30A 1 014980130

1498/50A

electronic multipurpose battery charger, 12V

For charging and powering vehicles
while reprogramming and self-diagnosing



SPECIFICATIONS

- Max. charging/power supply current: 50 Amp
- charging
- battery recovery
- power supply for ECU diagnostic protocols
- electronic management through microprocessor
- protected against polarity reversal and short circuits

TECHNICAL DATA

Cable length: 3m
 Section: 10 mm²
 Charging capacity: 5-500Ah
 Maintenance capacity: 5-1500Ah
 Voltage: 12V

1498/50A 1 014980050

150x100x250 mm

1498/120A

electronic multipurpose
battery charger, 12V

Allows batteries to be charged
and powers motor vehicles
while reprogramming and self-diagnosing



- maximum continuous charging current: 120A
- charging and maintenance with CPU microprocessor
- battery recovery function
- reprogramming and power supply for ECU
- protected against polarity reversal, short circuits, incorrect voltage and overload

TECHNICAL DATA

Power supply: 90-260V
 Power: 1500W
 Charging current: 10-120A
 Battery type: Agm - Wet - Lithium (LiFePo4)
 Charging capacity: 10-1200Ah
 Maintenance capacity: 5-3600Ah
 Output voltage: 12 Volt
 Cable length, with clamps: 2700 mm
 Dimensions: 310 x 150 x 350 mm
 Weight: 8.5 kg

1498/120A 1 014980142

1498/40A

multipurpose battery charger / starter, 12-24V
wheeled

Since no internal battery is available, the start function (max. 350A)
does not replace that of a specific starter type 1498LT/12 (2000A).



- 3 programmed charging cycles and 1 manual cycle
- electronic adjusting potentiometer
- specific WET-SPIRAL/GEL-AGM charging cycles
- electronic control and protection system
- 10-stage charging process
- battery desulfurization and recovery function
- supply function
- dual voltage, 12-24V
- also suitable for Start&Stop batteries
- professional rubber-insulated brass clamps

TECHNICAL DATA

Power supply: 230V
 Output voltage: 12-24V
 Charging current: 1-40A
 Starting current: 350A max cc
 Charging capacity: 4-450Ah

1498/40A 1 014980140

330x250x792

1498SM

memory saver, 12 V

prevents data stored by computer on board cars
from getting lost during maintenance jobs
or battery replacement.



Technical specifications:

- self-supplied
- internal battery Pb 5 Ah
- 12 volts
- professional connection with OBD socket

1498SM 1 014980020

1498SM-C

OB2 II car memory saver connectors, 12V, for item 1498SM/C



1498SM-C 1 014980021

1498SM-CP

car memory saver connectors, 12V clamp, for item 1498SM/CP



1498SM-CP 1 014980022

1498SM-A

memory saver power supplies for item 1498SM/A



1498SM-A 1 014980023

1498TB/12-24

digital battery tester, 12V, and starting/charging system analyzer, 12-24V

- allows the following to be tested: battery, alternator (smart and normal) and starter, diode ripple and chassis test
- fitted with software for printing test from PC
- backlit display
- compact, shockproof frame
- 10 language software
- complete with input for connecting a removable mini printer (optional accessory, Beta 1498ST/TB)



TECHNICAL DATA:

- applications: 12V battery test - Alternator charge test, 12-24V - Starter test
- operating range: 100-2000 CCA
- reference standards: CCA,SAE,DIN,EN,IEC,JIS
- supported batteries: PB, WET, GEL, AGM, AGM FLAT, EFB
- voltmeter: 9V-36V
- cable length: 1600 mm
- languages: Italian, English, French, German, Spanish, Polish, Romanian, Dutch, Swedish and Finnish
- accessories included: USB cable and software

1498TB/12-24 1 014980401

1498ST/TB

mini thermal printer for tester item 1498TB/12

- Mini printer can be directly connected to tester
- Allows test results to be printed



CE



1498ST/TB 1 014980410

1498ST/TB ROT

paper refill for printer 1498ST/TB



1498ST/TB ROT 2 014980411

1498PC

voltage stabilizer, 12-24 V

Protects control units in welding and starting processes



1498PC 1 014980801



1498TC

digital glow plug tester

Quick, accurate glow plug testing

- Suitable for all types of glow plugs, 4.4-5.7-8.5-10-11 Volts
- Digital backlit display
- Suitable for steel and ceramic glow plugs
- Short circuit and polarity reversal protection
- Turns off automatically when not in use
- With buzzer
- With SMD LED torch
- Compact, shockproof frame



CE

- Measurement range: 0.00-25.0Ω
- Tolerance: ± 2%
- Resolution: 0.01
- Led Display: 1.8"
- Operating temperature: 0°C+50°C
- Power supply: 1.9V battery (not included)

1498TC 1 014980450

1499

sonoscope probe



1499 1 014990001

1500/...
two-leg universal pullers

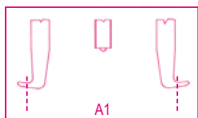

	L mm		
1500/1	100	1	015000301
1500/2	100	1	015000302
1500/3	150	1	015000303
1500/4	150	1	015000304
1500/5	205	1	015000305
1500/6	205	1	015000306
1500/7	205	1	015000307
1500/8	230	1	015000308

	A min+Max mm	A1 min+Max mm
1500/1	25÷80	70÷130
1500/2	25÷130	80÷180
1500/3	50÷160	105÷220
1500/4	60÷200	120÷270
1500/5	80÷250	160÷330
1500/6	80÷350	160÷420
1500/7	110÷520	195÷600
1500/8	170÷640	260÷715



1500/SP5	1	015000325
1500/1-1500/2-1500/3		
1500/4-1500/5		
1500/SPV	1	015000001

1500G/...
legs, pair, standard series,
for items 1500 and 1580/81



	± 0.05 mm	± 0.1 1500		
1500G/1	35	/1-2	1	015000311
1500G/3	35	/3-4	1	015000313
1500G/5	35	/5-6-7	1	015000315
1500G/8	50	/8	1	015000317
		1580/81		

1500N/...
universal pullers with 2 sliding legs



	A min+Max mm	L mm		
1500N/0	18÷65	70	1	015000600
1500N/1	23÷70	100	1	015000601
1500N/2	23÷100	100	1	015000602
1500N/3	35÷140	150	1	015000603
1500N/4	35÷190	150	1	015000604
1500N/5	43÷250	205	1	015000605
1500N/6	43÷320	205	1	015000606



1500N/SP6	1	015000626
1500N/0-1500N/1-1500N/2-1500N/3		
1500N/4-1500N/5		
1500N/SPV	1	015000006

1500N/G...
loose legs for pullers 1500N



	± 0.05 mm	± 0.1 1500N		
1500N/G0	10	/0	2	015000650
1500N/G1-2	12	/1-2	2	015000651
1500N/G3-4	17	/3-4	2	015000653
1500N/G5-6	23	/5-6	2	015000655

1501/1 - 2 - 3
thin leg pullers

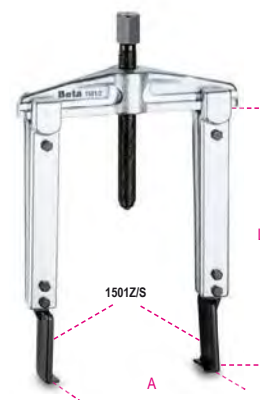

	L mm		
1501/1	100	1	015010101
1501/2	200	1	015010102
1501/3	250	1	015010103

	A min+Max mm
1501/1	25÷130
1501/2	25÷130
1501/3	25÷130

1501G/1 - 2 - 3
legs for item 1501



	L mm		
1501G/1	100	1	015010111
1501G/2	200	1	015010112
1501G/3	250	1	015010113

1501Z/S - P - R
leg ends for item 1501G



	± 0.05 mm	D mm		
1501Z/S	2.0	27	2	015010211
1501Z/P	3.6	27	2	015010212
1501Z/R	3.6	14	2	015010213



1505V

windshield and rear window wiper arm remover

Removable perforated brass tip for arm removal, with built-in washer jet



1505V	A Max mm	L mm	1	015050001
	43	37		

1505/C5

windshield wiper removal kit

1 two-leg puller, Ø 25÷40 mm
4 half-moon tools, Ø 25 mm, Ø 30 mm, Ø 35 mm, Ø 41 mm



1505/C5	1	015050300
Ø mm	12	

320x150x60 mm - 1,2 kg

1506

two-leg self-locking puller

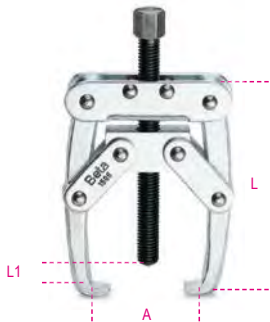

1506	A min+Max mm	L mm	L1 mm	1	015060001
	10÷50	80	40		

Beta

1508/1 - 1508/2

two-leg pullers, light series



1508/1	L mm	1	015080001
	105		
1508/2	L mm	1	015080002
	130		

1508/1	A min+Max mm	L1 mm
	6÷100	105
1508/2	A min+Max mm	L1 mm
	10÷140	130

1511/1 - 2 - 3

external pullers with two reversible legs

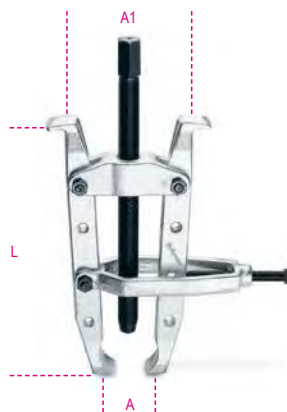

1511/1	L mm	1	015110001
	235		
1511/2	L mm	1	015110002
	330		
1511/3	L mm	1	015110003
	405		

1511/1	A min+Max mm	A1 min+Max mm
	20÷100	65÷95
1511/2	A min+Max mm	A1 min+Max mm
	40÷150	103÷190
1511/3	A min+Max mm	A1 min+Max mm
	40÷150	103÷175

1515/1 - 2 - 3

pullers with two floating legs



1515/1	L mm	1	015150101
	85		
1515/2	L mm	1	015150102
	85		
1515/3	L mm	1	015150103
	105		

1515/1	A Max mm	L1 mm
	60	105
1515/2	A Max mm	L1 mm
	70	105
1515/3	A Max mm	L1 mm
	90	105

1516/1 - 2 - 3

pullers with three floating legs



1516/1	L mm	1	015160001
	85		
1516/2	L mm	1	015160002
	85		
1516/3	L mm	1	015160003
	105		

1516/1	A Max mm	L1 mm
	60	85
1516/2	A Max mm	L1 mm
	70	85
1516/3	A Max mm	L1 mm
	90	105

1517

three-leg self-locking pullers

- For major pulling loads.
- Self-locking effect.

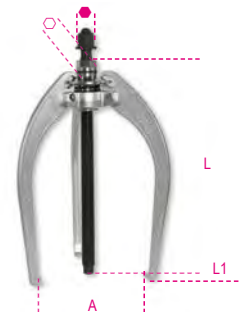

1517/90	L mm	L1 mm	Ø mm	1	015170000
	182	60	22		
1517/150	L mm	L1 mm	Ø mm	1	015170010
	242	115	22		
1517/200	L mm	L1 mm	Ø mm	1	015170020
	307	150	22		
1517/260	L mm	L1 mm	Ø mm	1	015170030
	395	180	30		

1517/90	● mm	A mm	kg	N
	19	18÷90	6000	59000
1517/150	● mm	A mm	kg	N
	19	25÷150	6000	59000
1517/200	● mm	A mm	kg	N
	19	40÷200	6000	59000
1517/260	● mm	A mm	kg	N
	27	50÷260	8000	78500

Beta

1518/...

three-leg pullers



	L mm		
1518/1	105	1	015180001
1518/2	135	1	015180002
1518/3	235	1	015180003
1518/4	270	1	015180004
1518/5	270	1	015180005
1518/6	270	1	015180006

	A min+Max mm	L1 mm
1518/1	24÷100	105
1518/2	32÷160	150
1518/3	40÷220	220
1518/4	80÷250	240
1518/5	80÷300	350
1518/6	80÷350	400

1520/1 - 1520/2

pullers with two reversible legs



	L mm		
1520/1	135	1	015200101
1520/2	235	1	015200102

	A Max mm	L1 mm
1520/1	110	85
1520/2	160	140

1521/1 - 1521/2

pullers with three reversible legs



	L mm		
1521/1	135	1	015210101
1521/2	235	1	015210102

	A Max mm	L1 mm
1521/1	110	90
1521/2	160	140

1528

self-locking puller
for brake discs



	Ø mm	A min+Max mm		
	19	170÷380	1	015280000

480x240x60 mm - 4,8 kg

1529

multi-step cone pulley puller

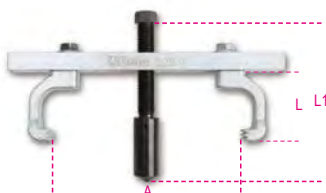

	A min+Max mm	L min+Max mm	L1 min+Max mm		
	24÷240	60÷95	90÷135	1	015290000

260x210x60 mm - 2,6 kg

1529/C7

pulley puller

Kit contents:

- 2 legs with two 4.7-mm-thick feet
- 2 legs with one 4.3-mm-thick foot
- 2 legs with two 2.3-mm-thick feet
- 1 leg with one 2.3-mm-thick foot

The pair of legs can be made up according to one's operating requirements



	L mm	L1 mm	A min+Max mm		
1529/C7	50	72,5	53÷114	1	015290100

285x155x50 mm - 2 kg

1529PI

universal injection pump pulley puller

• Allows fuel injection pump pulley to be quickly and accurately removed.
• Particularly suitable for Fiat, Ford, Volkswagen, Citroën and Peugeot vehicles.
Includes 3 pairs of screws for tightening puller to pulley:
M6 x 1.0 x 49 mm
M7 x 1.0 x 75 mm
M8 x 1.25 x 76 mm



1529PI	1	015290051
--------	---	-----------

1529/PG

high-pressure diesel oil pump puller,
for VAG group vehicles



	Ø mm		
	15-24	1	015290010

1530/C5

wheel hub and bearing pulling kit,
3, 4, 5 holes

Kit contents:

- 1 universal flange (96÷138 mm)
- 1 hydraulic screw (12 t)
- 1 hammer face (2.8 kg), required for hubs without central fixing bolts



1530/C5	1	015300300
---------	---	-----------

760x320x120 mm - 11,5 kg



1530/C16

hammer face kit with spacing studs,
for pulling wheel hubs and bearings
3, 4, 5 holes

Ideal for hubs with projecting centre rings

Kit contents:

- 1 universal flange (90÷130 mm)
- 1 hammer face (5 kg)
- 4 M12 coupling studs
- 4 M14 coupling studs



1530/C16 1 015300316
 ≡ 760x310x100 mm - 13,5 kg

1532

packing and oil seal removal tool



1532 2 015320001

1533/...

pullers for separators 1534



L mm		
1533/2	150	1 015330002
1533/3	210	1 015330003
1533/4	315	1 015330004
1533/5A	305	1 015330006

A min÷Max mm	L1 mm	
1533/2	45÷140	110
1533/3	55÷205	175
1533/4	90÷260	175
1533/5A	100÷360	235

1533PR/1 - 2 - 3

extensions for pullers 1533



1533PR/1	1 015330011
1533/2	
1533PR/2	1 015330012
1533/3	
1533PR/3	1 015330013
1533/4-5	
1533PR/5A	1 015330016
1533/5A	

1534/...

separators

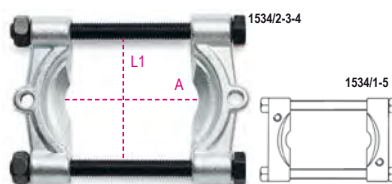

1534/1	1533/2	1 015340001
1534/2	1533/2	1 015340002
1534/3	1533/3	1 015340003
1534/4	1533/4	1 015340004
1534/5A	1533/5A	1 015340006

	A min÷Max mm	L1 mm
1534/1	5÷60	63
1534/2	12÷75	75
1534/3	22÷115	118
1534/4	25÷155	154
1534/5A	30÷220	180

1535/C...

puller kits



1535/C1 1 015350001

1533/2	
1533PR/1	
1534/1	
≡ 260x180x40 mm - 2,5 kg	

1535/C2 1 015350002

1533/2	
1533PR/1	
1534/2	
≡ 260x180x40 mm - 2,8 kg	

1535/C3 1 015350003

1533/3	
1533PR/2	
1534/3	
≡ 380x280x55 mm - 8,0 kg	

1535/C4 1 015350004

1533/4	
1533PR/3	
1534/4	
≡ 420x380x65 mm - 14,8 kg	

1535/C5A 1 015350006

1533/5	
1533PR/3	
1534/5	
≡ 530x510x85 mm - 27,2 kg	

1539

sheet sliding hammer



1539 1 015390001

1540

sliding hammer

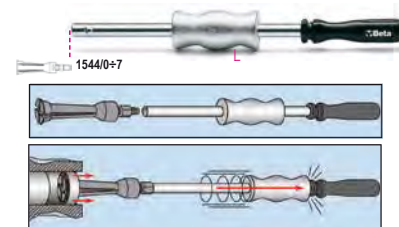

1540 L 390 mm, M10, 1544 0÷7, 1 015400001

1542/1 - 1542/2

two-leg pullers for extractors



	A	1544	
	min+Max		
	mm		
1542/1	35÷75	0÷7	1 015420001
1542/2	60÷130	9C-10C	1 015420002

	L	L1
	mm	mm
1542/1	140	140
1542/2	175	160

1544/...

internal extractors

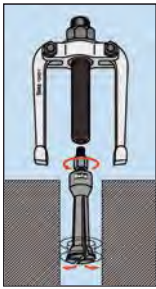

	C	mm	mm	
1544/0	0,25	M10		1 015440100
A= 5÷7				
1544/A	0,80	M10		1 015440105
A= 7÷9				
1544/1	0,80	M10		1 015440110
A= 9÷12				
1544/2	1,15	M10		1 015440120
A= 13÷17				
1544/2B	1,00	M10		1 015440121
A= 14÷19				
1544/3	1,70	M10		1 015440130
A= 16÷21				
1544/4	1,65	M10		1 015440140
A= 20÷25				
1544/5	2,00	M10		1 015440150
A= 25÷30				
1544/6	3,00	M10		1 015440160
A= 30÷37				
1544/7	3,80	M10		1 015440170
A= 38÷45				
1544/9C	2,60	G 3/8"		1 015440189
A= 40÷75				
1544/10C	7,30	G 3/8"		1 015440199
A= 70÷115				

1545/C5M

puller 1542/1 with 5 extractors 1544



1545/C5M 1 015450011

1542/1	● 24 mm
1544/1	9+12 mm
1544/2	13+17 mm
1544/3	16+21 mm
1544/4	20+25 mm
1544/5	25+30 mm

265x180x45 mm - 2,4 kg

1547/C6

dummy ball bearing extractors



1547/C6 1 015470006

420x185x60 mm - 3 kg

1547KP

set of 3 pairs of dummy ball terminals



	∅	mm	
1547KP/1	9-11-12,5		1 015470106
1547KP/2	5-6-8		1 015470206

1547P

hexagonal extensions



	L	mm	mm	
1547P/1	205	1547/1		1 015470101
1547P/2	102	1547/2		1 015470201

1547PC/2

round extensions, short series



	L	mm	mm	
1547PC/2	42	1547/2		1 015470202

1547PL/2

round extensions, long series



	L	mm	mm	
1547PL/2	106	1547/2		1 015470203

1549

kit for removing and installing double effect shock absorbers with gas return

allows stem to be kept straightened while springs are being installed



1549 1 015490001

310x270x110 mm - 3 kg



1550U

pneumatic shock absorber removal tool for cars, SUVs and commercial vehicles

CE

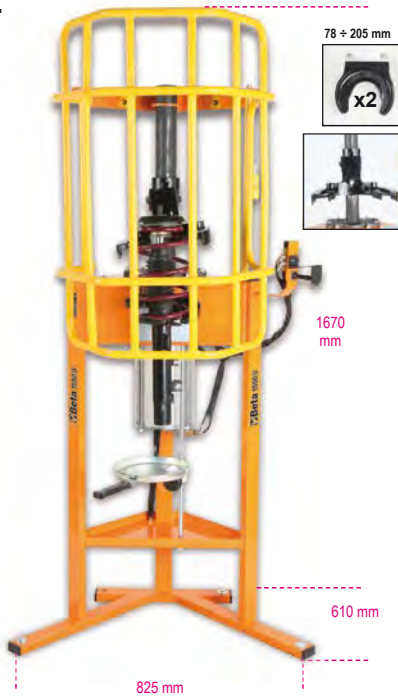

INCREASED POWER: maximum thrust 2 tons (10 bars)
UPPER UNIVERSAL HOLD SYSTEM: allows all left/right-hand spring diameters to be compressed with one upper adaptable plate.

ACTIVE SAFETY SYSTEM ON SPRING: safety hook and 3 locking valves allow spring to be properly positioned/seated, maintaining such position throughout compression.

If spring is not positioned properly, system will stop machine.
PROTECTIVE "FULL BODY" GRILLE: provides maximum safety and working area coverage

CONTROL LEVER OPERATION: increased accuracy and sensitivity during compression stage

WORKING POSITION: working height on rear fork raised up to 875 mm

Supplied with 2 lower forks for diameters 78-205 mm

TECHNICAL DATA

Maximum thrust: 2 tons (10 bars) - 1.6 tons (8 bars) - 1.2 tons (6 bars)
 Spring compression stroke: 335 mm

1550U

1 015500010

1550U/CGS-R

lowered upper jaws, pair, for item 1550U



1550U CGS-R

1 015500035

1550U/MRC-ABE

special forks for item 1550U, specially designed for Mercedes A-B-E Class cars



1550U/MRC-ABE

1 015500031

1550U/MRC-C

special forks for item 1550U, specially designed for Mercedes C class cars



1550U/MRC-C

1 015500032

1550U/S...

lower fork for item 1550U



	∅ mm		
1550U/S 130	78÷130 mm	1	015500014
1550U/S 182	105÷182 mm	1	015500015
1550U/S 205	125÷205 mm	1	015500016

1550U/SS187

left-hand fork for item 1550U

Particularly suitable for left-hand springs, e.g. Nissan Qashqai and Renault Koleos



1550U/SS 187

1 015500018

1550U/M

vice for shock absorber removal tool item 1550U

Allows shock absorber stem to be locked



1550U/M

1 015500021

1551/C20

kit for removing shock absorber heads

Kit contents:

- 7 hexagon sockets, sizes: 16 - 17 - 18 - 19 - 21 - 22 - 24
- 1 socket extension, length: 120 mm
- 3 slotted female bits, sizes: 8x5 - 8x6 - 11x8
- 1 female hexagon bit, size: 10 mm
- 1 male XZN(R) bit, size: M10
- 1 male Torx(R) bit, size: T50
- 4 male hexagon bits, sizes: 5 - 6 - 7 - 8
- 1 bit holder extension, length: 95 mm
- 1 bit holder extension, length: 190 mm



1551/C20

1 015510020

320x245x71 mm - 2,6 kg

1552/C9

kit for spreading shock absorber, wishbone and steering wheel joints apart

working with single or double retractor head also makes it possible to work on double joints, e.g. from VAG group



1552/C9

1 015520020

195x140x40 mm - 1,0 kg



1555/Q

compressor for MacPherson and equivalent shock absorber springs

Maximum thrust: 1500 kg

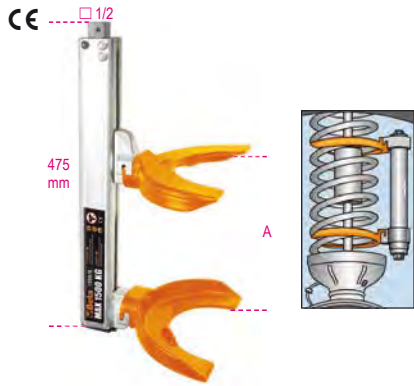

A	Ø	
min+Max	min+Max	
mm	mm	
65÷354	80÷195	1 015550006

1555/QS

compressor for MacPherson and equivalent shock absorber springs



A	Ø	
min+Max	min+Max	
mm	mm	
70÷300	80÷200	1 015550005

1555S/BMW-RNT

fork for BMW E39, E46 and Renault Mégane II shock absorbers, for items 1555Q and 1555/QS



1555S/BMW-RNT	1 015550303
---------------	-------------

1555C

telescopic compressor for shock absorber springs with 4 forks and torsion bar



A	Ø	N	t	
min+Max	min+Max			
mm	mm			
80÷225	90÷160	25000	8,5	1 015550202

1556/1A

compressor for shock absorber springs

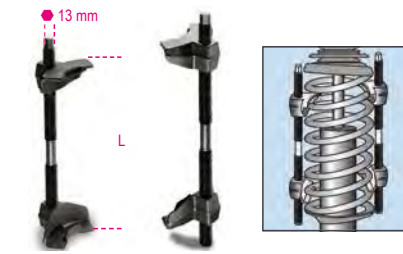

min L Max		
mm		
65÷320	1 015560101	

1556/2A

compressor for shock absorber springs

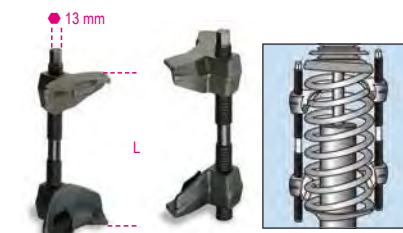

min L Max		
mm		
65÷200	1 015560102	

1557

impact sockets for truck leaf springs



L	L1	
mm	mm	
37	28	1 015570137
46	34	1 015570146
56	34	1 015570156

1557V

impact sockets for Volvo leaf springs



mm		
27	1 015570299	

1557/S3

set of 3 sockets for shock absorber nuts

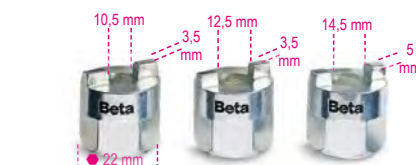

1557/S3	1 015570010
---------	-------------

1558/C4

internal and external snap ring tool, screw-operated

square drive allows a high force to be applied in both operating conditions
Supplied tips:
Ø 2.5-3-3.5 mm



1558/C4	5,5÷77	5,5÷77	1 015580100
330x220x50 mm - 900 g			

1558P

snap ring tips, pair, for item 1558



Ø		
mm		
2,5	1 015580125	
3,0	1 015580130	
3,5	1 015580135	

1558/C13

internal and external snap ring tool, screw-operated

square drive allows a high force to be applied in both operating conditions

supplied tips:
• straight: Ø 2.5 - 3 - 3.5 - 3.8 mm
• 45°: Ø 2.5 - 3 - 3.5 - 3.8 mm
• 90°: Ø 2.5 - 3 - 3.5 - 3.8 mm



1558/C13	5,5÷77	5,5÷77	1 015580200
330x220x45 mm - 1,6 kg			

1559
ball joint puller, light series



	A Max mm	Ø mm		
1559/22	50	18÷22	1	015590001
1559/36	90	36	1	015590036
1559/45	115	45	1	015590045

1559V/8T
hydraulic screw for ball joint pullers 1559/36
and 1559/45

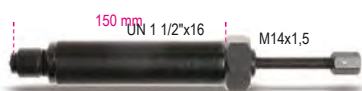

Nm	t		
80000	8	1	015590145

1560/1 - 1560/2
ball joint pullers, professional type



	A min+Max mm	Ø mm		
1560/1	12÷50	20	1	015600001
1560/2	60÷85	20	1	015600002

1560A
ball joint puller



1560A	1	015600601
-------	---	-----------

1561/...
ball joint pullers



	L mm	A mm	Ø mm		
1561/1	39	36,6	18	1	015610001
1561/2	47	45,7	25	1	015610002
1561/3	63	62	30	1	015610003
1561/4	75	63	40	1	015610004

1562D
ball joint puller

Supplied with 2 screws for pulling suspension and steering joints



A max mm	Ø mm	• mm	L mm		
50	39	26	155	1	015620239

1565/1 - 2 - 3
fork separators for ball joints



	Ø mm	L1 mm		
1565/1	18	65	1	015650001
1565/2	23	65	1	015650002
1565/3	30	88	1	015650003

1566N
tool for removing/installing steering arms



Ø x L mm	Ø mm	□ mm		
28÷35 x 400	27	12 ⁷	1	015660005
35÷45 x 190	27	-	1	015660008
35÷45 x 400	27	12 ⁷	1	015660010

1566/G01
homokinetic joint puller

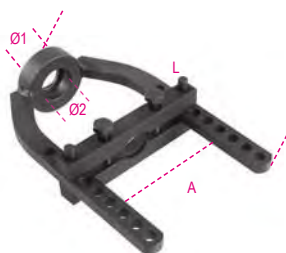

L mm	A mm	Ø1 mm	Ø2 mm		
250	115	29	36	1	015660052

1566P
ribbed axle shaft
circlip pliers

Pliers compress circlip, making it easier to fix axle shaft into homokinetic joint



L mm	A Max mm		
280	36	1	015660091

1567
lever for removing wishbone heads
and shock absorbers from pillar

Can be used by one operator



A mm	B min+Max mm		
1060	100÷300	1	015670001

1569/A
assortment of tools for removing and installing
rear axle silent blocks,
driving shaft oil seals and wheel bearings

- Bushings can be used both on vehicle and on hydraulic press
- Kit contents:
4 threaded bars: M10-M12-M14-M16
4 washers
bushings for diameters ranging from 44 mm to 82 mm



1569/A	1	015690011
--------	---	-----------

530x415x115 mm

1569/B
assortment of tools for removing and installing
silent blocks, oil seals and wheel bearings

diameter: 14÷32 mm



1569/B	1	015690015
--------	---	-----------

1569/F

tool assortment for removing and inserting Fiat Panda, Fiat 500 and Ford Ka silentblocks



1569/F 1 015690021

1569CP

striking tools for installing conical bearings and oil seals

Quick adjustment



	∅ min+Max mm	L mm		
1569CP/50	9,5÷50	130	1	015690750
1569CP/90	18÷90	145	1	015690790

1570/3

hydraulic presses for pullers



t	L mm	L1 mm	∅ mm	
30	243	36	19	1 015700003



1580/8I

two-leg hydraulic puller

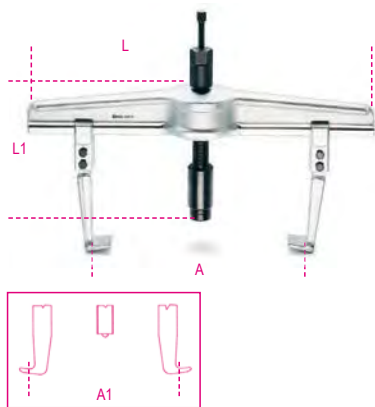

1580/8I 1 015800008

	A min+Max mm	L mm	L1 mm	A1 min+Max mm	N Max
1580/8I	170÷640	715	280	260÷715	180000

1580GL

loose legs, long series, for pullers item 1580/8I



	L mm		
1580GL/8A	300	1	015800227
1580GL/8B	400	1	015800228
1580GL/8C	500	1	015800229

1585/5I - 6I - 7I

three-leg pullers for hydraulic use

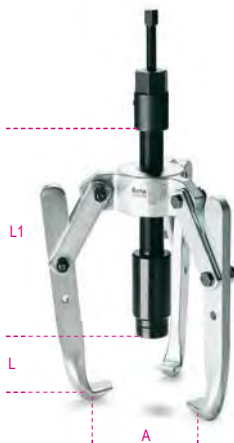

1585/5I 1 015850005
1585/6I 1 015850006
1585/7I 1 015850007

	A min+Max mm	L1 mm	L mm	N Max
1585/5I	50÷350	135	280	150000
1585/6I	50÷350	235	280	150000
1585/7I	50÷350	335	280	150000

1585GI/5 - 6 - 7

legs for hydraulic puller
1585/I-1585/6I-1585/7I

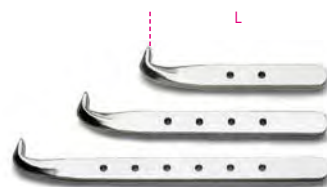

	L mm		
1585GI/5	135	1	015850205
1585GI/6	235	1	015850206
1585GI/7	335	1	015850207

1589VI

hydraulic screw for pullers
1580/8I and 1585/5I - 1585/6I - 1585/7I



1589VI 1 015890001

1589PI/50 - 100 - 150

extension sockets for hydraulic screw



	L mm	L1 mm		
1589PI/50	50	70	1	015890005
1589PI/100	100	120	1	015890010
1589PI/150	150	170	1	015890015

1590

standard clamps



A max mm	L1 mm		
60	55	2	015900305
80	65	2	015900307
100	65	2	015900310
120	85	2	015900312
150	95	2	015900315

1591

screw clamps



A ~	A max mm	L1 mm		
200	200	80	2	015910020
300	310	85	2	015910030
400	410	85	2	015910040
500	500	95	2	015910050
600	600	95	2	015910060
800	800	95	2	015910080
1000	1000	110	2	015910100

1593

screw clamps

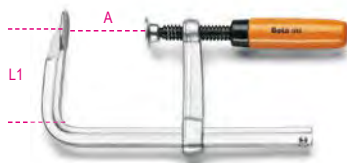

A	A max	L1		
mm	mm	mm		
160	170	80	2	015930016
200	240	100	2	015930020
300	320	145	2	015930030

1594

lever bar clamps

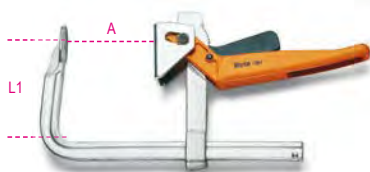

A	A max	L1		
mm	mm	mm		
200	240	145	1	015940020
250	290	145	1	015940025
300	340	145	1	015940030
400	430	150	1	015940040
500	530	150	1	015940050
600	630	150	1	015940060

1595

screw clamps

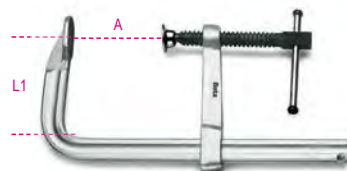

A	A max	L1		
mm	mm	mm		
200	230	100	2	015950020
250	270	120	2	015950025
300	330	120	2	015950030
400	420	120	2	015950040
500	520	125	2	015950050
600	620	125	2	015950060
800	820	125	1	015950080
1000	1030	125	1	015950100

1599F

parallel bench vices

with hardened top and slides



L1	BxH	Ø	A MAX		
mm	mm	mm	mm		
100	92x46	11	111	1	015990100
125	108x54	13	130	1	015990125
150	125x62	13	150	1	015990150
175	140x70	15	170	1	015990175

1599P

parallel bench vices

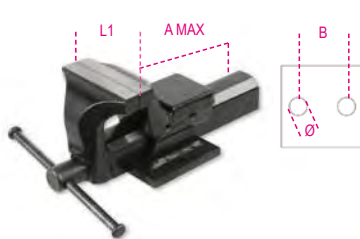

L1	B	Ø	A MAX		
mm	mm	mm	mm		
100	92	11	111	1	015990000
125	108	13	130	1	015990025
150	130	15	170	1	015990050

1599B

revolving bases for vices item 1599P



	1599P		
• 1599B 100	100	1	015990810
• 1599B 125	125	1	015990812
1599B 150	150	1	015990815

1599T

parallel drill vices

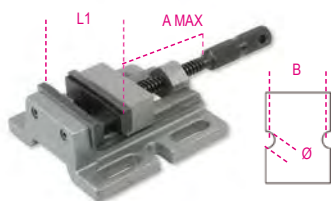

L1	B	Ø	A MAX		
mm	mm	mm	mm		
80	111	11	65	1	015990480
100	120	13	87	1	015990500

1599G

pairs of aluminium jaw covers



A		
mm		
100	1	015990910
125	1	015990912
150	1	015990915
180	1	015990917

1600Q 8

four-way wrench for control panel operators

square 5 / 6 / 7-8 mm
triangle 9 mm
flaps 3-5 mm
hexagon 1/4"
slotted head 1.0x7 mm + cross head PH2

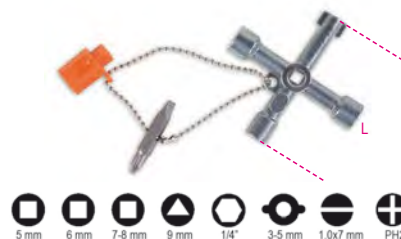

L		
mm		
76	1	016000008

1600Q 10

eight-way wrench with articulated joint, for control panel operators

square 5 / 6-7 / 8-9 mm
triangle 5-6 / 6-7 / 8-9 mm
flaps 3-5 mm
hexagon 1/4"
male drive 1/4"



L		
mm		
125	1	016000010

1601/PC

ratchet crimping pliers for telephone terminals and data transmission

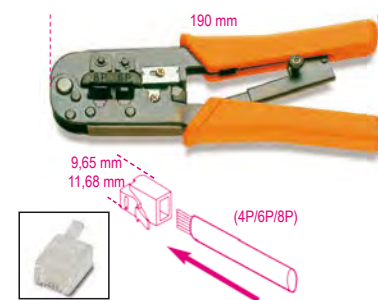

RJ11-RJ12-RJ45	2	016010011

1602

crimping pliers for insulated terminals, light series

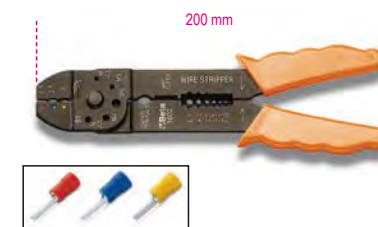

mm ²	0,75÷6	5 016020001

1602/C9

crimping pliers, light series,
with assortment of 450 terminals



1602/C9 1 016020045

1602	n.
BM00180 R/6,3	50
BM00280 B/6,3	50
BM00380 G/6,3	50
BM00191 R/6,3	50
BM00291 B/6,3	50
BM00392 G/6,3	50
BM00160 R/1,6	50
BM00260 B/2,3	50
BM00360 G/3,6	50

420x350x35 mm - 1,5 kg

1602A

crimping pliers for insulated
terminals, standard model



mm²
0÷6 2 016020005

1603

crimping pliers for non-insulated
terminals, light series

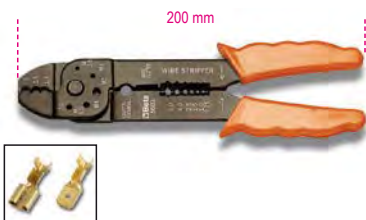

mm²
1,25÷5,5 5 016030001



1603A

crimping pliers for non-insulated
closed terminals, standard model

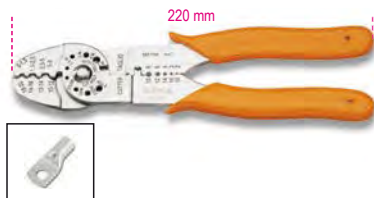

mm²
0÷8 2 016030005

1603B

crimping pliers for non-insulated
open terminals, standard model

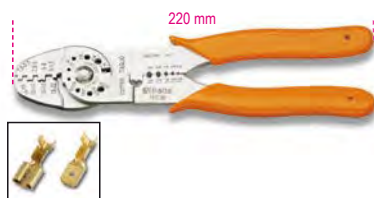

mm²
0÷8 2 016030010

1606/2

heavy duty crimping pliers
for cylindrical terminals



mm² L A B
0,14÷10 175 65 20 1 016060002

1606A

crimping pliers for tubular terminals



mm²
1606A6 0,5÷6 1 016060010
1606A16 6÷16 1 016060016

1606A/C9

crimping pliers for tubular terminals
with assortment of 450 terminals, 0,5÷6 mm²



1606A/C9 1 016060045

1606A6	n.
BM00601 W/0,5	50
BM00604 N/1,5	100
BM00506 B/2,5	100
BM00508 G/4	100
BM00610 Y/6	100

420x350x35 mm - 2,5 kg

1606T

crimping pliers for tubular terminals, 4-sided
crimping

reduced lever stress



mm² L A B
0.1÷10 173 61 13 1 016060005

1607

heavy duty crimping pliers
for BNC coaxial wires RG 58, RG 59,
RG 62, RG 71

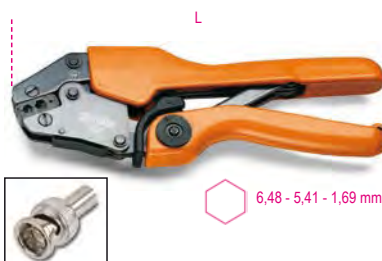

mm L A B
1607 220 73 19 1 016070001

1608

crimping pliers for insulated terminals, with pressure regulator



	mm ²		
0,5÷6		1	016080001

1608/C9

pliers with assortment of 450 terminals



1608/C9		
	1	016080045

1608		n.
BM00180	R/6,3	1
BM00280	B/6,3	50
BM00380	G/6,3	50
BM00191	R/6,3	50
BM00291	B/6,3	50
BM00392	G/6,3	50
BM00160	R/1,6	50
BM00260	B/2,3	50
BM00360	G/3,6	50

420x350x35 mm - 2 kg

1608A

heavy duty crimping pliers for insulated terminals



	mm ²		
0,75÷6		1	016080005

1609

crimping pliers for non-insulated terminals, professional model fast performance



	mm ²		
0,5÷2,5		1	016090001

1609A

heavy duty crimping pliers for non-insulated terminals



	mm ²		
0,5÷6		1	016090005

1609B

crimping pliers for noninsulated terminals



punch crimps, 10 mm ² ÷ 120 mm ²			
	L		
mm	mm ²	1	016090101
600	10÷120		

1609C/C5

oil-pressure crimping pliers with 5 pairs of dies

hexagonal crimps,
25 mm² ÷ 240 mm²



	mm ²		
50÷240		1	016090210

500x300x110 mm - 4 kg

1609M

dies for item 1609C

hexagonal crimps



		mm ²		
1609M/16		10-16	1	016090221
1609M/35		25-35	1	016090223
1609M/70		50-70	1	016090225
1609M/120		95-120	1	016090227
1609M/150		150	1	016090229
1609M/185		185	1	016090231
1609M/240		240	1	016090233

1639S

nylon wire puller

with interchangeable heads



L	∅		
m	mm	1	016390010
10	4		

1640K

oil-pressure punching machine with 4 punches

round punches
22.5-25.5-32.5-55.5 mm



1640K		
	1	016400001

470x400x100 mm

1640

sheet metal punch press



1640		
	1	016400100



1640A

adapter for item 1640



1640A 1 016400080

1640P

threaded pin for item 1640



	∅ mm		
1640P/9	9,5	1	016400088
1640P/19	19	1	016400089

1640Q

square punches for item 1640



1640Q 45 45x45 1 016400065

1640T

round punches for item 1640

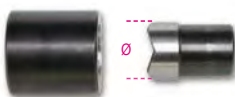

	∅ mm		
1640T 22,5	22,5	1	016400022
1640T 25,5	25,5	1	016400025
1640T 32,5	32,5	1	016400032
1640T 55,5	55,5	1	016400055

1650

sliding gauge
reading to 0.05 mm



UNI EN ISO 13385-1DIN 862

A max mm	L mm		
150	235	1	016500001
200	290	1	016500002

1650FD

sliding gauge for brake discs
reading to 0.1 mm

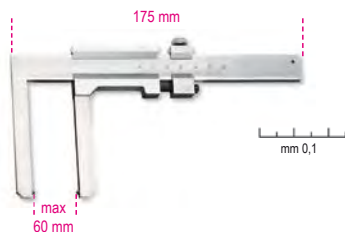

1650FD 1 016500050

1650FT

sliding gauge for brake drums
made from stainless steel
reading to 0.05 mm

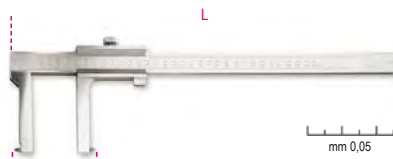

	A max mm	L mm		
1650FT/1	350	438	1	016500060
1650FT/2	500	550	1	016500070

1651DGT

digital vernier
reading to 0.01 mm

- Reading to 0.01 mm
- Screw slider locking
- mm/inch conversion

CE



UNI EN ISO 13385-1DIN 862CE

A Max mm	L mm		
150	225	1	016510111
200	285	1	016510112

1651DGT/IP

digital vernier,
reading to 0.01 mm, degree of protection IP67

Total protection against dust and liquids; it also works when it is completely immersed.

CE



UNI EN ISO 13385-1 DIN 862CE

1651DGT/IP 1 016510611

270x115x35 mm - 450 g

1652

analogue vernier,
analogue reading to 0.02 mm



UNI EN ISO 13385-1DIN 862

1652 1 016520016

1654

workshop verniers,
reading to 0.02 mm



UNI EN ISO 13385-1DIN 862

A max mm	L mm		
200	330	1	016540020
300	410	1	016540030

1654DGT

digital vernier,
reading to 0.01 mm
reading to 0.0005"

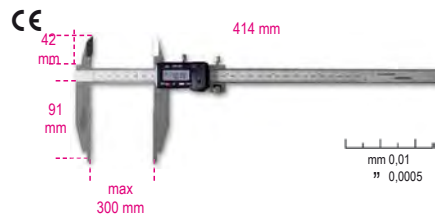

UNI EN ISO 13385-1DIN 862CE

1654DGT 1 016540111

1656

depth gauge, reading to 0.02 mm

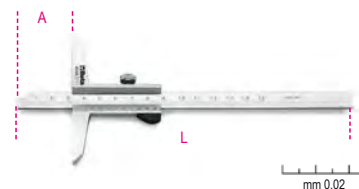

UNI EN ISO 13385-2DIN 862

A max mm	L mm		
200	260	1	016560020
300	360	1	016560030

1657DGT/2

digital depth gauge
reading to 0.01 mm
reading to 0,0005"

CE



UNI EN ISO 13385-2DIN 862CE

1657DGT/2	A max mm	L mm	1	016570002
	200	270		

1658/...

outside micrometers,
reading to 0.01 mm



DIN 863/II

1658/25	A mm	1	016580025
1658/50	0÷25	1	016580050
1658/75	25÷50	1	016580075
1658/100	50÷75	1	016580100
	75÷100	1	016580100

1658/C4

assortment of 4 micrometers
item 1658



DIN 863

1658/C4	1	016580001

1658/25	0÷25 mm
1658/50	25÷50 mm
1658/75	50÷75 mm
1658/100	75÷100 mm

365x245x35 mm - 2,5 kg

1658DGT

outside micrometers,
reading to 0.001 mm

CE



DIN 863CE

1658DGT25	A mm	1	016580325
1658DGT50	0÷25	1	016580350
	25÷50	1	016580350

1658SP/1

base for micrometer



1658SP/1	1	016580910

1659

thickness gauge with dial indicator,
reading to 0.01 mm

C=dial field



1659	C mm	1	016590001
	0÷10		

1662/1 - 1662/2

dial indicator, reading to 0.01 mm

C=dial field



1662/1	C mm	1	016620001
1662/2	0÷5	1	016620001
	0÷10	1	016620010

1662DGT/A

digital dial indicator,
reading to 0.01 mm

C = Dial field

CE



1662DGT/A	C mm	1	016620311
	0-12,5		

1662AN

adjustable stylus dial indicator,
reading to 0.01 mm

C=Dial field



DIN 2270

1662AN	C mm	1	016620200
	0÷0,8		

1662SP0

magnetic base



1662SP0	1	016620800

Beta

Beta

1662SP2

magnetic base, rotating



1662SP2 1 016620910

1666

precision squares
made from stainless steel ground
and lapped



DIN 875/0

L mm	L1 mm		
100	70	1	016660210
150	100	1	016660215
200	130	1	016660220
250	165	1	016660225
300	200	1	016660230

1666A

flanged precision squares
made from stainless steel ground
and lapped



DIN 875/0

L mm	L1 mm		
100	70	1	016660110
150	100	1	016660115
200	130	1	016660120
250	170	1	016660125
300	200	1	016660130

1668

squares
made from normalized,
ground steel



DIN 875/2

L mm	L1 mm		
100	70	2	016680210
150	100	2	016680215
200	130	2	016680220
250	165	1	016680225
300	174	1	016680230

1668A

flanged precision squares
made from normalised, ground steel



DIN 875/2

L mm	L1 mm		
100	70	2	016680110
150	100	2	016680115
200	130	2	016680120
250	165	1	016680125
300	176	1	016680130

1670

squares
made from ground steel



L mm	L1 mm		
100	70	3	016700010
150	100	3	016700015
200	130	3	016700020
250	160	3	016700025
300	175	3	016700030
400	230	2	016700040
500	280	2	016700050
600	330	2	016700060
800	420	1	016700080
1000	500	1	016700099

1670A

flanged precision squares
made from ground steel



L mm	L1 mm		
100	70	3	016700110
150	100	3	016700115
200	130	3	016700120
250	165	3	016700125
300	175	3	016700130
400	230	2	016700140
500	280	2	016700150
600	330	2	016700160
800	420	1	016700180
1000	500	1	016700199

1672

mitre square, adjustable sliding blade,
base and blade made from steel

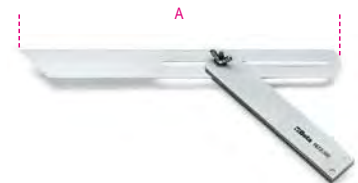

A mm		
300	2	016720030

1672A

mitre square, adjustable,
sliding blade, aluminium base,
blades made from chrome-plated steel

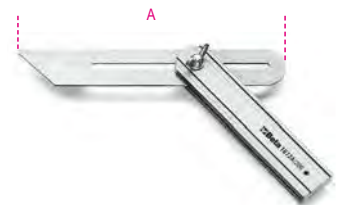

A mm		
200	3	016720120
300	3	016720130





1674A

carpenter's squares blades
made from stainless steel,
with aluminium bases, double metric scale



L mm	L1 mm		
300	169	2	016740130
400	214	2	016740140

1676

protractors made from stainless steel

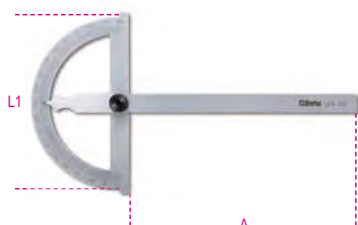

A	A	L1	G		
120	120	80	1°	2	016760012
150	165	120	1°	2	016760015
200	210	150	1°	2	016760020
300	310	200	1°	1	016760030

1678/C3

bevel protractor
made from stainless steel

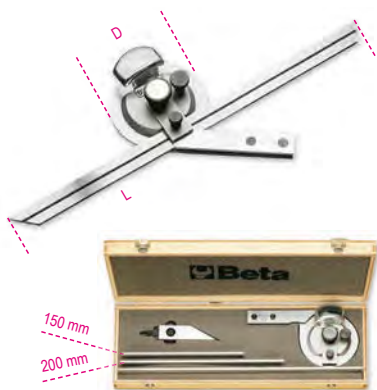

L Max mm	D mm		
300	70	1	016780030

1679

universal gauge with contact-roll,
made from stainless steel,
reading to 0.1 mm

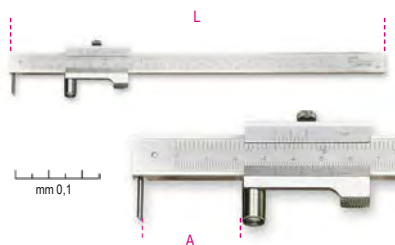

L mm	A Max mm		
235	200	1	016790020

1679/PR

spare tip for universal gauge 1679



1679/PR	1	016790021
---------	---	-----------

1680

tammels, hardened steel body
and tips

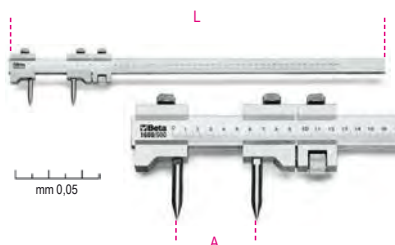

L mm	A Max mm		
660	500	1	016800050

1680A

inside callipers



L mm	A Max mm		
150	144	2	016800115
200	200	2	016800120
250	245	1	016800125
300	300	1	016800130

1680B

outside callipers



L mm	A Max mm		
150	155	2	016800215
200	190	2	016800220
250	235	1	016800225
300	280	1	016800230

1680C

precision dividers,
hardened steel straight tips



L mm	A Max mm		
150	138	2	016800315
200	190	2	016800320
250	235	1	016800325
300	280	1	016800330

1682

flexible graduated rules
made from stainless steel

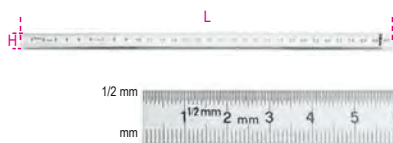

L mm	H mm	\pm mm		
150	13	0,5	5	016820015
200	13	0,5	5	016820020
250	13	0,5	5	016820025
300	13	0,5	5	016820030
500	13	0,5	2	016820050
1000	13	0,5	2	016820100

1683

semi-rigid graduated rules
made from stainless steel

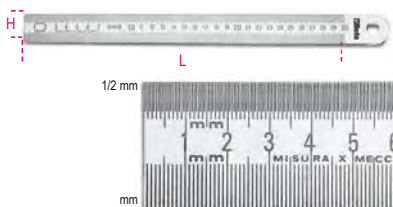

L mm	H mm	\pm mm		
300	30	1	5	016830030
500	30	1	2	016830050
1000	30	1	2	016830100
1500	30	1	1	016830150



1685/C7

assortment of 7 measuring and marking tools



1685/C7 1 016850110

	1650	160 mm
	1658/25	0+25 mm
	1670	100 mm
	1680C	150 mm
	1682	150 mm
	1688BC	165 mm
	1688BC/R	

320x210x37 mm - 1,2 kg

1687A

engineer's precision scribe, tip bent at 90°, with handle



1687A L mm 153 L1 mm 80 1 016870120

1687AC

engineer's precision scribe, short tip bent at 90°, with handle



1687AC L mm 153 L1 mm 80 1 016870125

1687D

engineer's precision scribe, straight tip, with handle



1687D L mm 153 L1 mm 80 1 016870110

1687U

engineer's precision scribe, hook tip, with handle



1687U L mm 153 L1 mm 80 1 016870115

1687/S4

set of 4 engineer's precision scribes, with handles



1687/S4 1 016870150
1687A-1687AC
1687D-1687U

1688

engineer's scribe made from hardened steel



1688 L mm 250 Ø mm 2 5 016880020

1688A

engineer's scribe made from hardened steel



1688A L mm 200 Ø mm 4 5 016880120

1688PC

engineer's scribe made of chrome-plated, hardened steel



1688PC L mm 150 Ø mm 1 1 016880300

1688PC/R

spare tip for item 1688PC



1688PC/R 1 016880310

1688M

carpenter's pencil



1688M L mm 180 50 016880880

1690F

folding ruler made of fibreglass precision class III



1690F/2 L m 2 S mm 17 5 016900220

1690L

folding ruler made of birch precision class III



1690L/2 L m 2 S mm 17 5 016900200

1691BM

measuring tapes shock-resistant bimaterial ABS casings, steel tapes, precision class: II

CE



1691BM/5 L m 5 S mm 25 1 016910205
1691BM/8 8 32 1 016910208
1691BM/10 10 32 1 016910210

1692

measuring tapes, shock-resistant bi-material ABS casings, steel tapes, precision class II

CE



1692/2 L m 2 S mm 16 5 016920052
1692/3 3 16 5 016920053
1692/5 5 19 5 016920055
1692/8 8 25 5 016920058

1693

laser distance meter,
20 m

MEASUREMENTS:

- single distance measurement
- continuous measurement or minimal measurement

Auto off feature

Battery life: up to 4,000 measurements

CE
IP54



TECHNICAL DATA

Measurement range: 0.05 + 20m (0.2in + 66f)

Scale selection: m, in, ft

Measurement accuracy: ±1.5 mm (± 0.06 in)

Laser class: 2

Battery life: AAA 2 x 1.5V

	H mm	L mm	S mm		
1693 20	100	36	23	1	016930020

1693M

laser distance meter, multipurpose,
80 m

MEASUREMENTS:

- single distance measurement
- continuous measurement or minimal measurement

FUNCTIONS:

- addition/subtraction
- area measurement
- volume measurement
- indirect measurement (Pythagorean measurement)
- tilt measurement

Auto off feature

Soft cloth case (included)

Battery life: up to 4,000 measurements

CE
IP54



TECHNICAL DATA

Measurement range: 0.05 + 80 m (0.2 in + 229f)

Scale selection: m, in, ft

Measurement accuracy: ±1.5 mm (± 0.06 in)

Laser class: 2

Max. storage: 99 units

Batteries: AAA 2 x 1.5V

	H mm	L mm	S mm		
1693M 80	115	48	29	1	016930080

1694/L

measuring tapes shock-resistant
ABS casings, PVC-coated fibreglass tapes,
precision class III

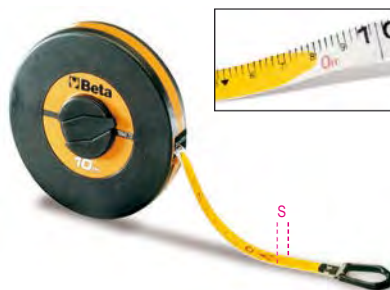

	L m	S mm		
1694L10	10	13	1	016940110
1694L20	20	13	1	016940120

1694A/L

measuring tapes with handles,
shock-resistant ABS casings,
PVC-coated fibreglass tapes,
precision class III



	L m	S mm		
1694A/L30	30	13	1	016940230
1694A/L50	50	13	1	016940250

1694B/L

measuring tape with handle,
aluminium casing, varnished steel tape,
precision class II



	L m	S mm		
1694B/L50	50	12,5	1	016940350

1695XS

pocket spirit level with magnetic V-shaped
base

made from profiled aluminium

2 unbreakable vials

accuracy: 1mm/m



L mm	H mm	S mm		
70	48,5	20	5	016950250

1696

spirit levels made from anodized profile
aluminium, with 2 unbreakable vials,
accuracy: 1 mm/m



L mm	H mm	S mm		
200	50	19	2	016960002
400	50	19	2	016960004
500	50	19	2	016960005
600	50	19	2	016960006
800	50	19	2	016960008
1000	50	19	2	016960010

1696A

spirit levels made from die-cast
aluminium, with 1 ground base
and 2 unbreakable vials, accuracy: 1 mm/m



L mm	H mm	S mm		
300	43	23	2	016960103
400	43	23	2	016960104
500	43	23	2	016960105
600	43	23	2	016960106
800	43	23	1	016960108
1000	43	23	1	016960110

1696B

spirit levels with magnetic bases
made from anodized profiled aluminium,
2 unbreakable vials accuracy: 1 mm/m



L mm	H mm	S mm		
200	49	22	2	016960202
300	49	22	2	016960203
400	49	22	2	016960204
500	49	22	2	016960205
600	49	22	2	016960206



1696D

spirit levels made of die-cast aluminium with handles,
4 ground bases and 3 unbreakable vials,
accuracy: 1 mm/m



L mm	H mm	S mm		
300	47	25	2	016960353
400	47	25	2	016960354
500	47	25	2	016960355
600	47	25	2	016960356

1696S

levelling staffs made from aluminium, with 2
unbreakable vials

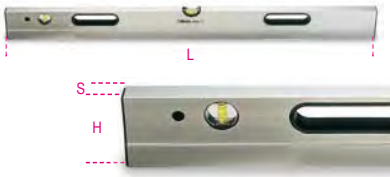

L mm	H mm	S mm		
1500	90	25	1	016960415
2000	90	25	1	016960420
2500	90	25	1	016960425
3000	90	25	1	016960430

1699L

precision surface level made from
die-cast iron with ground prismatic
base, 2 unbreakable vials,
accuracy: 0.05 mm/m



DIN 877

	L mm	A mm		
1699L	200	49	1	016990002

1699L/1

precision surface level made
from die-cast iron with ground prismatic
base, 2 unbreakable vials,
accuracy: 0.02 mm/m



DIN 877

	L mm	A mm		
1699L/1	200	49	1	016990005

1699Q

precision square levels made from
die-cast iron with 2 prismatic bases
and 2 ground flat bases, 2 unbreakable vials,
accuracy: 0.05 mm/m



DIN 877

	L mm	A mm		
	150	40	1	016990015
	200	48	1	016990020

1700N

masonry points



	L mm	S mm		
	250	16	5	017000005
	300	16	5	017000006

1700N/PM

masonry points
with hand guards



	L mm	S mm		
	250	16	2	017000105
	300	16	2	017000106

1701N

masonry chisels



	L mm	A mm	S mm		
	250	23	16	5	017010001
	300	23	16	5	017010003

1701N/PM

masonry chisels
with hand guards



	L mm	A mm	S mm		
	250	23	16	2	017010101
	300	23	16	2	017010103

1701PMR

hand guards for items 1700N and 1701N



	D mm	L mm		
	16	115	1	017010206

1701NE/...

electrician's chisels



		SxL mm		
1701NE3	10x200		5	017010406
1701NE4	10x250		5	017010409

1702N

extra-wide chisels



	A mm	SxH mm		
	50	12x25	2	017020005
	70	12x25	2	017020007

1702N/PM

extra-wide chisels
with hand guards



	A mm	SxH mm		
	50	12x25	2	017020105
	70	12x25	2	017020107



We recommend frequent cooling
of the tool while regrinding it.

1702PMR

hand guard for item 1702N



	L mm		
	115	1	017020200

1704
carpenter's wrenching bars

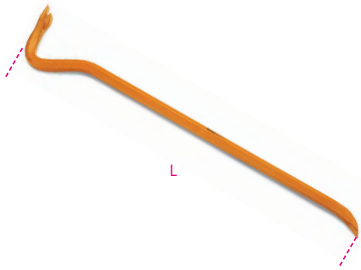

L mm	6 mm	mm	mm		
500	16	35	28	2	017040050
600	16	34	26	2	017040060
800	18	38	29	2	017040080

1704A
crow bars with open and pointed edges

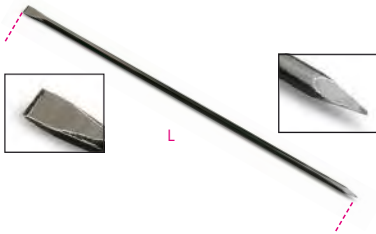

L mm	6 mm	mm		
1500	25	45	1	017040110
2000	28	55	1	017040120

1704C
crow bars with closed and pointed edges



L mm	8	min-MAX mm	mm		
1200		21-31	39	1	017040210
1400		31-37	42	1	017040212
1600		25-37	42	1	017040215

1705
chalk line reel made from aluminium



L m				
1705	30		4	017050001

1705PT
chalk powder



g				
250		5	017050025	

1706DGT
digital depth gauge for tyre threads



1706DGT		1	017060011	

1707
screw pitch gauge
For ISO 60° metric and Whitworth 55° threads



P (ISO)	W			
0,25÷6	62÷4x1"	5	017070001	

1707A/1 - 2 - 3
radius gauges,
concave and convex steel blades



	R mm	L mm	n		
1707A/1	1,0÷7,0	70	34	2	017070007
1707A/2	7,5÷15	85	32	2	017070015
1707A/3	15,5÷25	85	30	2	017070025

1708/8 - 13 - 20
metric feeler gauges



1708/8	S = 0,05±0,50 mm	5	017080008	
1708/13	S = 0,05±1,00 mm	5	017080013	
1708/20	S = 0,05±1,00 mm	5	017080020	

1709/10 - 1709/18
nut splitters



	L mm	A max mm		
1709/10	90	17 (M10)	1	017090010
1709/18	108	25 (M16)	1	017090018

1710
hydraulic nut splitters



C min mm	C max mm			
7 (M4)	22 (M14)	1	017100001	

1712E/1 - 2 - 3
flexible magnetic pick up tools

F = magnetic power



	L mm	D mm	F kg		
1712E/1	420	7,5	0,5	2	017120011
1712E/2	530	15	1,8	2	017120012
1712E/3	532	19	3,0	2	017120013

1712E/L1
flexible magnetic pick-up tool with LED light

F = magnetic force
Battery: 2xLR48

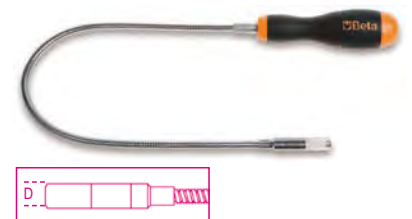

	L mm	D mm	F kg		
1712E/L1	500	11	0,75	2	017120111



1712E/R-L1

spare heads for item 1712E/L1, with LED and magnet

1712E/R-L1	1	017120611
------------	---	-----------

1712TF

telescopic magnet with flexible head

• With washer jet cleaner
F= magnetic force



L	D	F	
mm	mm	kg	
150÷590	11	1	1 017120600

1713M

flexible pickup tools

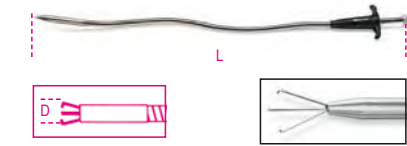

L	D	
mm	mm	
500	7	2 017130011
1000	7	1 017130015

1714

inspection mirror made from plastic



L	D		
mm	mm		
174	155	25	
			5 017140001

1715

telescopic joint inspection mirror
chrome-plated metal body



L	D		
mm	mm		
175	180÷540	30	
			1 017150001

1715FL/A

square flexible inspection mirror



L	A	B	
mm	mm	mm	
1715FL/A	600	53	90
			1 017150110

1715R/FL

kit of 2 inspection mirrors for items 1715FL/A and 1715FL/B

1715R/FL	1	017150151
----------	---	-----------

1715FL/B

rectangular flexible inspection mirror
with light

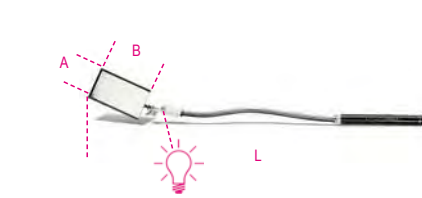

L	A	B	
mm	mm	mm	
1715FL/B	553	53	90
			1 017150115

1715B/R5L

kit of 5 spare light bulbs for item 1715FL/B

1715B/R5L	1	017150152
-----------	---	-----------

1716A

angled bit for general use



L	L1	■	
mm	mm	mm	
1716A	240	125	6
			3 017160040

1716P

packing scraper



L	L1	●	
mm	mm	mm	
1716P	250	125	6
			3 017160020

1716Q

square bit reamer



L	L1	∅	
mm	mm	mm	
1716Q	215	100	6
			5 017160010

1716R

round bit reamer



L	L1	∅	
mm	mm	mm	
1716R	215	100	6
			5 017160001

1716U

hook bit for general use

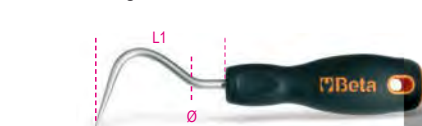

L	L1	∅	
mm	mm	mm	
1716U	195	80	6
			3 017160025

1717A

scrapers, two cutting edges



L	L1	L2	
mm	mm	mm	
150	70	260	2 017170015
200	75	310	2 017170020
250	100	360	2 017170025

1717B

scrapers, three cutting edges



L	L1	L2	
mm	mm	mm	
150	75	260	2 017170115
200	85	310	2 017170120
250	100	360	2 017170125

1717C

flat scrapers, varnished

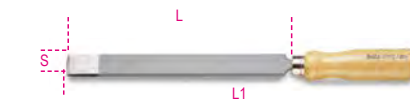

L	S	L1	
mm	mm	mm	
150	18	270	2 017170215
200	20	320	2 017170220
250	25	370	2 017170225

1717D

flat scraper, front cut



L	S	L1	
mm	mm	mm	
1717D	150	23	240
			2 017170320

1717T

triangular blade scrapers,
complete with 2 blades



L		
mm		
1717T	310	1 017170610

1717T RT

spare triangular blades



L		
mm		
1717T RT	65	1 017170660

1717T RS

spare shaped blades



1717T RS	1	017170661
----------	---	-----------

1717V

paint scrapers,
blades can be used on several sides



	L mm	A mm		
1717V 38	200	38	1	017170703
1717V 65	285	65	1	017170706

1717V R

spare blades for item 1717V



	L mm			
1717V R38	38		1	017170753
1717V R65	65		1	017170756

1718D...Q

rough square files, without handles

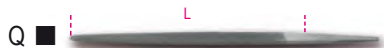

	L mm	L "		
1718D6/Q	150	6	5	017180121
1718D8/Q	200	8	5	017180131
1718D10/Q	250	10	5	017180141

1718A...Q

second-cut square files, without handles



	L mm	L "		
1718A6/Q	150	6	5	017180021
1718A8/Q	200	8	5	017180031
1718A10/Q	250	10	5	017180041

1718D...T

rough triangular files, without handles



	L mm	L "		
1718D6/T	150	6	5	017180123
1718D8/T	200	8	5	017180133
1718D10/T	250	10	5	017180143

1718A...T

second-cut triangular files, without handles

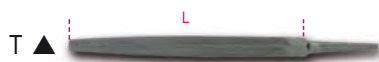

	L mm	L "		
1718A6/T	150	6	5	017180023
1718A8/T	200	8	5	017180033
1718A10/T	250	10	5	017180043

1718D...P

rough flat files, without handles



	L mm	L "		
1718D6/P	150	6	5	017180125
1718D8/P	200	8	5	017180135
1718D10/P	250	10	5	017180145

1718A...P

second-cut flat files, without handles



	L mm	L "		
1718A6/P	150	6	5	017180025
1718A8/P	200	8	5	017180035
1718A10/P	250	10	5	017180045

1718D...M

rough half-round files, without handles



	L mm	L "		
1718D6/M	150	6	5	017180127
1718D8/M	200	8	5	017180137
1718D10/M	250	10	5	017180147

1718A...M

rough half-round files, without handles



	L mm	L "		
1718A6/M	150	6	5	017180027
1718A8/M	200	8	5	017180037
1718A10/M	250	10	5	017180047

1718D...R

rough round files, without handles



	L mm	L "		
1718D6/R	150	6	5	017180129
1718D8/R	200	8	5	017180139
1718D10/R	250	10	5	017180149

1718A...R

second-cut round files, without handles

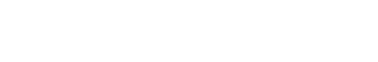

	L mm	L "		
1718A6/R	150	6	5	017180029
1718A8/R	200	8	5	017180039
1718A10/R	250	10	5	017180049

1718D...S5

set of 5 rough files, without handles



	L mm	L "		
1718D6/S5	150	6	1	017180130
1718D8/S5	200	8	1	017180140
1718D10/S5	250	10	1	017180150

1718A...S5

set of 5 second-cut files, without handles



	L mm	L "		
1718A6/S5	150	6	1	017180030
1718A8/S5	200	8	1	017180040
1718A10/S5	250	10	1	017180050

1719BMD...Q

rough square files, with handles



	L mm	L "		
1719BMD6/Q	150	6	5	017190191
1719BMD8/Q	200	8	5	017190221
1719BMD10/Q	250	10	5	017190241
1719BMD12/Q	300	12	3	017190325

1719BMA...Q

second-cut square files, with handles



	L mm	L "		
1719BMA6/Q	150	6	5	017190021
1719BMA8/Q	200	8	5	017190052
1719BMA10/Q	250	10	5	017190071
1719BMA12/Q	300	12	3	017190311

1719BMX...Q

smooth square files, with handles



	L mm	L "		
1719BMX6/Q	150	6	5	017190022
1719BMX8/Q	200	8	5	017190053
1719BMX10/Q	250	10	5	017190072

1719BMD...T

rough triangular files, with handles



	L mm	L "		
1719BMD6/T	150	6	5	017190193
1719BMD8/T	200	8	5	017190223
1719BMD10/T	250	10	5	017190243
1719BMD12/T	300	12	3	017190326

1719BMA...T

second-cut triangular files, with handles



	L mm	L "		
1719BMA6/T	150	6	5	017190023
1719BMA8/T	200	8	5	017190054
1719BMA10/T	250	10	5	017190073
1719BMA12/T	300	12	3	017190313

1719BMX...T

smooth triangular files, with handles



	L mm	L "		
1719BMX6/T	150	6	5	017190024
1719BMX8/T	200	8	5	017190055
1719BMX10/T	250	10	5	017190074

1719BMD...P

rough flat files, with handles



	L mm	L "		
1719BMD6/P	150	6	5	017190195
1719BMD8/P	200	8	5	017190225
1719BMD10/P	250	10	5	017190245
1719BMD12/P	300	12	3	017190327

1719BMA...P

second-cut flat files, with handles



	L mm	L "		
1719BMA6/P	150	6	5	017190025
1719BMA8/P	200	8	5	017190056
1719BMA10/P	250	10	5	017190075
1719BMA12/P	300	12	3	017190315

1719BMX...P

smooth flat files, with handles

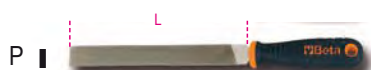

	L mm	L "		
1719BMX6/P	150	6	5	017190026
1719BMX8/P	200	8	5	017190057
1719BMX10/P	250	10	5	017190076

1719BMD...M

rough half-round files, with handles



	L mm	L "		
1719BMD6/M	150	6	5	017190197
1719BMD8/M	200	8	5	017190227
1719BMD10/M	250	10	5	017190247
1719BMD12/M	300	12	3	017190328

1719BMA...M

second-cut half-round files, with handles



	L mm	L "		
1719BMA6/M	150	6	5	017190027
1719BMA8/M	200	8	5	017190058
1719BMA10/M	250	10	5	017190077
1719BMA12/M	300	12	3	017190317

1719BMX...M

smooth half-round files, with handles



	L mm	L "		
1719BMX6/M	150	6	5	017190028
1719BMX8/M	200	8	5	017190059
1719BMX10/M	250	10	5	017190078

1719BMD...R

rough round files, with handles



	L mm	L "		
1719BMD6/R	150	6	5	017190199
1719BMD8/R	200	8	5	017190229
1719BMD10/R	250	10	5	017190249
1719BMD12/R	300	12	3	017190329

1719BMA...R

second-cut round files, with handles



	L mm	L "		
1719BMA6/R	150	6	5	017190029
1719BMA8/R	200	8	5	017190060
1719BMA10/R	250	10	5	017190079
1719BMA12/R	300	12	3	017190319

1719BMX...R

smooth round files, with handles



	L mm	L "		
1719BMX6/R	150	6	5	017190031
1719BMX8/R	200	8	5	017190061
1719BMX10/R	250	10	5	017190081

1719BMA...B5

set of 5 second-cut files, with handles, in wallet



	L mm	L "		
1719BMA8/B5	200	8	1	017190297
1719BMA10/B5	250	10	1	017190298

1719BMD...B5

set of 5 rough files, with handles, in wallet



	L mm	L "		
1719BMD8/B5	200	8	1	017190303
1719BMD10/B5	250	10	1	017190305

1719BMD...S5

set of 5 rough files, with handles



	L mm	L "		
1719BMD6/S5	150	6	1	017190200
1719BMD8/S5	200	8	1	017190230
1719BMD10/S5	250	10	1	017190250
1719BMD12/S5	300	12	1	017190363

1719BMA...S5

set of 5 second-cut files, with handles



	L mm	L "		
1719BMA6/S5	150	6	1	017190030
1719BMA8/S5	200	8	1	017190070
1719BMA10/S5	250	10	1	017190080
1719BMA12/S5	300	12	1	017190361

1719BMX...S5

set of 5 smooth files, with handles



	L mm	L "		
1719BMX6/S5	150	6	1	017190032
1719BMX8/S5	200	8	1	017190069
1719BMX10/S5	250	10	1	017190082

1719BMB/P

universal cut flat files, plastic handles



L mm	L "		
250	10	5	017190152
300	12	5	017190153

1719BMC

half-round and flat files, plastic handles

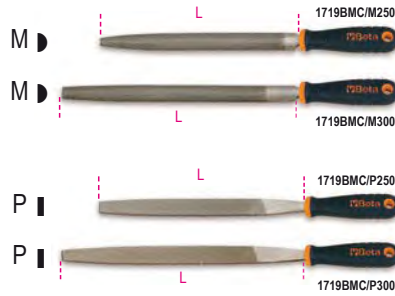

UNI 5569 - UNI 5568

	L mm	L "		
1719BMC/M 250	250	10	6	017190252
1719BMC/M 300	300	12	4	017190253
1719BMC/P 250	250	10	6	017190262
1719BMC/P 300	300	12	4	017190263

1719BM/RR

round rasp, plastic handle



	L mm	L "		
1719BM/RR	200	8	5	017190351

1719BM/RL

flat rasp file, plastic handle



	L mm	L "		
1719BM/RL	200	8	5	017190360

1719BMR

handles for files



	L mm	A mm		
1719BMR/0	95	25	10	017190950
1719BMR/0B	110	29	10	017190955
1719BMR/1	110	29	10	017190951
1719BMR/1B	110	29	10	017190953
1719BMR/2	123	31	10	017190952
1719BMR/2B	123	31	10	017190954

	L mm	A mm		
1719BMR/0	100/150	4/6	▲▲	▶▶
1719BMR/0B	100/150	4/6	■●	▶▶
1719BMR/1	150/200	6/8	▲▲	▶▶
1719BMR/1B	150/200	6/8	■●	▶▶
1719BMR/2	250/300	10/12	▲▲	▶▶
1719BMR/2B	250/300	10/12	■●	▶▶



1720/...

second cut needle files, shaft Ø 3 mm

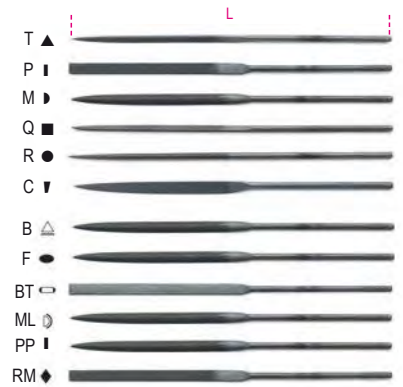

UNI 5569 UNI 5670

	L mm		
1720T	160	5	017200004
1720P	160	5	017200006
1720M	160	5	017200008
1720Q	160	5	017200009
1720R	160	5	017200010
1720C	160	5	017200012
1720B	160	5	017200005
1720ML	160	5	017200007
1720BT	160	5	017200011
1720F	160	5	017200013
1720PP	160	5	017200014
1720RM	160	5	017200015



1720/S3	1	017200000
---------	---	-----------

1720/B

set of 6 needle files in plastic wallet



1720/B6	1	017200002
1720/B12	1	017200003

1720D/...

diamond needle files
grit D126



	L mm		
1720D/T	160	2	017200104
1720D/P	160	2	017200106
1720D/M	160	2	017200108
1720D/Q	160	2	017200109
1720D/R	160	2	017200110
1720D/C	160	2	017200112



1720D/B6 1 017200120

1721/B6

set of 6 files for ignition contacts in plastic wallet



1721/B6 1 017210010

1723

spring puller



1723 L mm 210 5 017230001

1725

hacksaw frame

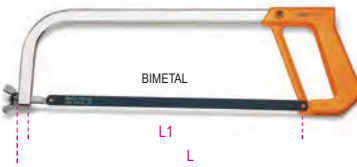

1725 L mm 420 L1 mm 300 4 017250001

1725CR

mini hacksaw frame



1725CR L mm 250 L1 mm 150 5 017250010

1726

hacksaw frame, blade attachment system in the handle



1726 L mm 440 L1 mm 300 4 017260001

1726BM

Hacksaw frame with quick release blade attachment system

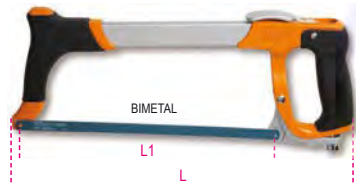

1726BM L mm 400 L1 mm 300 1 017260050

1727

hacksaw frame, heavy series

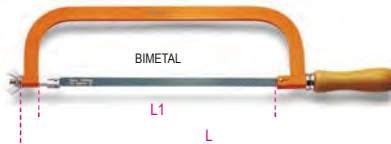

1727 L mm 515 L1 mm 300 4 017270001

1727BM

hacksaw frame, one hand grip



1727BM L mm 315 L1 mm 300 5 017270020

1728...

blades for hacksaw frames



1728LA 100 017280001

1725CR 100 017280010

1728BM 100 017280010

1725-1726 50 017280030

1727-1727M 50 017280030

1728CO 1725-1726 1727-1727M

50 017280030

1729

fixed frame hacksaw

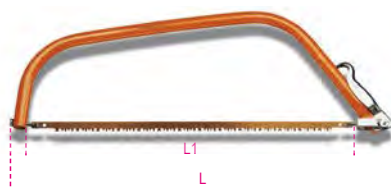

1729 L mm 710 L1 mm 610 5 017290001

1729LR

spare blade for item 1729



1729LR 10 017290010

1729CG

plasterboard saw



1729CG L mm 310 L1 mm 160 2 017290200

1729DM 450

wood rip saw

medium toothing, 12 teeth/inch



1729DM 450 L mm 450 L1 mm 400 4 017290450

1730

universal spatulas, with stainless steel blades and handles



S mm	L mm	L1 mm	
38	210	85	2 017300038
63	220	95	2 017300063
75	220	95	2 017300075
100	220	95	2 017300100

1730M

mixer spatulas, with stainless steel blades and handles



L1 mm	L mm	S mm	
120	245	27	2 017300215
200	330	28	2 017300220
250	365	36	2 017300225

1730V 38

glazier's spatula, knife blade made from stainless steel



S mm	L mm	L1 mm	
38	225	100	2 017300338

1736A

file brush
stainless steel wires,
wire Ø: 0.5 mm



1736A	L mm	240	10	017360010
-------	---------	-----	----	-----------

1737

brush, corrugated brass wires,
wire Ø: 0.2 mm



1737	L mm	145	10	017370001
------	---------	-----	----	-----------

1737NX

brake shoe cleaning brush, brassed steel
wires,
wire Ø: 0.3 mm



1737NX	L mm	270	5	017370010
--------	---------	-----	---	-----------

1737AC

steel wire brush,
5 rows,
wire Ø: 0.3 mm



1737AC	L mm	275	5	017370020
--------	---------	-----	---	-----------

1737B

pairs of vehicle battery lug
and post cleaner steel brushes,
steel wire
wire Ø: 0.3 mm



1737B	1	017370050
-------	---	-----------

1738

bristle brush



1738	L mm	210	H mm	30	10	017380001
------	---------	-----	---------	----	----	-----------

1739B

lazy tongs riveter, supplied
with 5 interchangeable nozzles



Ø mm	3,2	4	4,8	5	6	6,4
Aluminium	•	•	•	•	•	•
Stainless steel	•	•	•	•		

1739B	1	017390151
-------	---	-----------

1740A

heavy duty riveting pliers supplied
with 5 interchangeable nozzles



Ø mm	3,2	4	4,8	5	6	6,4
aluminium	•	•	•	•	•	•
stainless steel	•	•	•	•		

1740A	1	017400101
-------	---	-----------

1740B

compact heavy-duty riveting pliers,
supplied with 5 interchangeable nozzles



Ø mm	2,4	3	3,2	3,2	4,8
aluminium	•	•	•	•	•
steel	•	•	•	•	•
stainless steel	•	•	•	•	•

1740B 280	L mm	280	1	017400280
-----------	---------	-----	---	-----------

Ø mm	2,4	3,2	4,0	4,8	6,4
aluminium	•	•	•	•	•
steel	•	•	•	•	•
stainless steel	•	•	•	•	•

1740B 330	L mm	330	1	017400330
-----------	---------	-----	---	-----------

1741B

riveting pliers supplied
with 4 interchangeable nozzles



Ø mm	2,4	3,2	4	4,8	5
Aluminium	•	•	•	•	•
Steel	•	•	•	•	•
Stainless steel	•	•	•		

1741B	1	017410000
-------	---	-----------

1741B/C5

riveting pliers item 1741B with assortment
of 700 aluminium rivets



1741B/C5	1	017410025
----------	---	-----------

	Ø mm	L mm	n.
1741RV2,9K	3,0	6	200
1741RV3,2K	3,2	8	200
1741RV3,8K	4,0	10	100
1741RV4K	4,0	12	100
1741RV4,8K	4,8	12	100

415x155x60 mm - 3,1 Kg

1741BP

riveting pliers supplied
with 4 interchangeable nozzles



Ø mm	2,4	3,2	4	4,8	5
Aluminium	•	•	•	•	•
Steel	•	•	•	•	•
Stainless steel	•	•	•	•	•

1741BP	1	017410350
--------	---	-----------

1741U

ultra compact riveting pliers with adjustable force
with 4 interchangeable nozzles
3 legs: enhanced rivet hold





Ø mm	2,4	3	3,2	4	4,8
Aluminium	•	•	•	•	•
Steel	•	•	•	•	•
Stainless steel	•	•	•	•	•

1741U  1 017410450

1741RV...K

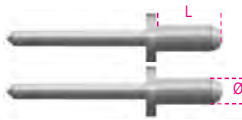
aluminium rivets



1741RV 2,9K	 1 017410191
ØxL = 3x6 mm	
1741RV 3,2K	1 017410192
ØxL = 3,2x8 mm	
1741RV 3,8K	1 017410193
ØxL = 4x10 mm	
1741RV 4K	1 017410194
ØxL = 4x12 mm	
1741RV 4,8K	1 017410195
ØxL = 4,8x12 mm	

1742

riveting pliers for threaded rivets,
with 4 interchangeable mandrels (1x
M3;M4;M5;M6)



1742  1 017420001

M	Ø mm	L mm
3	5	11
4	6	11
5	7	13
6	9	17

1742KR

spare mandrels for item 1742



M3	 1 017420043
M4	1 017420044
M5	1 017420045
M6	1 017420046

1742R-AL/M...

aluminium threaded rivets for items
1742-1742A-1946KF



1742R-AL M3	 1 017420023
ØxL = 5x10 mm	
M = 3	
1742R-AL M4	1 017420024
ØxL = 6x12 mm	
M = 4	
1742R-AL M5	1 017420025
ØxL = 7x13 mm	
M = 5	
1742R-AL M6	1 017420026
ØxL = 9x15 mm	
M = 6	

1742R-A/M...

steel threaded rivets for items
1742-1742A-1946KF



1742R-A M3	 1 017420013
ØxL = 5x11 mm	
M = 3	
1742R-A M4	1 017420014
ØxL = 6x11 mm	
M = 4	
1742R-A M5	1 017420015
ØxL = 7x13 mm	
M = 5	
1742R-A M6	1 017420016
ØxL = 9x17 mm	
M = 6	
• 1742R-A M8	1 017420018
ØxL = 11x17 mm	
M = 8	
• 1742R-A M10	1 017420020
ØxL = 13x24 mm	
M = 10	

1742/C4

riveting pliers item 1742
with assortment of 400 threaded
steel insets



1742/C4  1 017420005

	M	Ø mm	n.
1742R-A/M3	3	5	100
1742R-A/M4	4	6	100
1742R-A/M5	5	7	100
1742R-A/M6	6	9	100

 415x155x60 mm -  2,9 kg

1742A

heavy duty riveting pliers for threaded insets,
with 4 interchangeable mandrels





1742A  1 017420100

M	Ø mm	L mm
5	7	13
6	9	17
8	11	17
10	13	24

1742A/KR

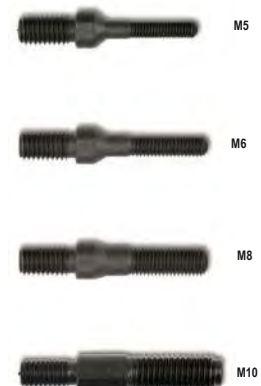
spare pins for item 1742A



1742A/KR M5	M5	 1 017420143
1742A/KR M6	M6	1 017420144
1742A/KR M8	M8	1 017420145
1742A/KR M10	M10	1 017420146



1742A/C

riveting pliers item 1742A with assortment of 60 threaded steel insets



1742A/C 1 017420105

	M	mm	n.
1742R-A/M5	5	7	20
1742R-A/M6	6	9	20
1742R-A/M8	8	11	10
1742R-A/M10	10	13	10

536x310x80 mm - 2,1 kg

1743

fitting tool for nylon ties

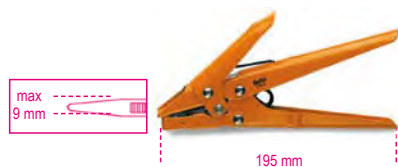

1743 1 017430001

1743T

cable tie cutting tool

• Also suitable for cutting small cables (3x1.5mm²; 1x17mm²)



1743T 1 017430100

1749

bonding gun varnished metal sheet



1749 2 017490001

1749A

bonding gun, professional model aluminium tube



1749A 1 017490010

1749A/RB

spare spouts for item 1749A

1749A/RB 2 017490051

1749A/RT

front screw plugs for item 1749A

1749A/RT 1 017490052

1749AC

high thrust gun for chemical binders



1749AC 1 017490005

1750

lever operated grease guns

Can be used with cartridges 1750CG or loose grease



1 g, 550 bar Max

1750CG	cc	cc	L mm	
400	500	380	1	017500500
600	750	450	1	017500750

1750R/1 - 1750R/2

spare flexible hose made from nylon



	L mm	
1750R/1	310	2 017500030
1750R/2	410	2 017500040

1750RC

curved rigid hose



	L mm	M mm	
1750RC	150	10x1	2 017500050

1750RT

4-jaw grease fitting "Hydraulic" type



	M mm	
1750RT	10x1	5 017500110

1750RP/1 - 1750RP/2

heads for flat nozzles



	Ø mm	M mm	
1750RP/1	16	10x1	2 017500115
1750RP/2	22	10x1	2 017500120

1750CG

grease cartridges for item 1750



cc		
400	18	017500140
600	18	017500160

1750KG10

lever-operated grease gun, 10 kg,
with high-pressure hose, 2 m

complete with swivel fitting, to avoid choking hose
die-cast aluminium pump body with check valve

3 different pressure levels available:

- 4 g at 275 bar
- 7 g at 206 bar
- 9 g at 137 bar



312.5 mm

1750KG10 1 017500100

1750TA

high-pressure, self-locking 6-pin grease nozzle

Once positioned, it remains on axis and connected to nipple;
it does not have to be held like common nozzles

Easy to disconnect, even with pressurized nozzle

Thread M10x1: suitable for all types of grease guns: electric,
pneumatic, manual etc.

Deformation-free up to 550 bar



17 mm
30 mm

1750TA 1 017500111

1750TLA

high-pressure, self-locking 6-pin grease
nozzle, long version

Once positioned, it remains on axis and connected to nipple

Easy to disconnect, even with pressurized nozzle

Thread M10x1: suitable for all types of grease guns: electric,
pneumatic, manual etc.

Deformation-free up to 550 bar



17 mm
80 mm

1750TLA 1 017500112

1750M

mini grease gun

- With micro nozzle
- Particularly suitable for pneumatic tools



Ø 0.5 mm

	cc	D mm	L mm		
1750M	100	43	145	1	017500025

1751

metal pressure oil cans flexible spout



cc	D mm	L mm		
200	62	140	4	017510002
300	75	140	4	017510003
500	85	140	4	017510005
750	100	140	2	017510007
1000	100	140	2	017510011

1751R

spare spout for item 1751



200÷1000 5 017510010

1752

plastic pressure cans rigid spouts



cc	D mm	L mm		
200	67	140	4	017520002
300	77	140	4	017520003
500	95	140	4	017520005
700	95	140	2	017520007

1752R

spare spout for item 1752



cc 200÷700 5 017520020

1753

plastic pressure oil cans flexible spouts



cc	D mm	L mm		
200	65	190	4	017530002
300	80	190	4	017530003
500	95	190	4	017530005
700	95	190	2	017530007

1753R

spare spout for item 1753



cc 200÷700 5 017530020

1754

plastic pressure oil cans flexible
plastic spouts



cc	D mm	L mm		
150	60	130	5	017540015
250	65	130	5	017540025

1755

plastic oil bottles retractable spouts



cc	L mm	A mm		
30	160	30	5	017550003
80	170	47	5	017550008
150	230	58	5	017550015

1756

pen oiler



cc	L mm		
5	140	2	017560001

1756B

pen oiler

• Operating temperature: -10°C - +60 °C



cc	L mm		
500	280	2	017560220

1756C

suction gun, 200 ml, made of polypropylene

- Also suitable for braking system fluid
- Double EPDM gasket
- Operating temperature: +0 - +50 °C
- NOT suitable for fuel



1756C	1	017560502
-------	---	-----------

1756D

suction gun, 1500 ml, made of polypropylene

- Double NBR gasket
- Operating temperature: +0 - +50 °C
- NOT suitable for fuel

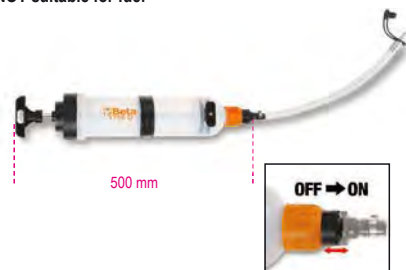

1756D	1	017560515
-------	---	-----------

1756G

diesel oil gun capacity: 1.5 l

- Can be used to:
- fill diesel oil filters
 - fill Cerina tank



- Kit contents:
- 2 pipes with female quick couplings for connecting diesel oil pipes
 - 2 male quick couplings, made of metal
 - 1 cone-shaped adapter for rubber pipes

1756G	1	017560615
-------	---	-----------

1756C-20R

O-rings (pair) for suction guns 1756C

1756C-20R	1	017560503
-----------	---	-----------

1756D-20R

O-rings (pair) for suction guns 1756D

1756D-20R	1	017560516
-----------	---	-----------

1757

battery fillers



cc	D mm		
250	60	4	017570002
500	75	4	017570004
1000	90	2	017570006

1756C	1	017560502
-------	---	-----------

1757A

battery filler



cc 2000	1	017570020
---------	---	-----------

1758

self-adapting funnel

particularly useful for cars with no depth in inlet plugs



1758	1	017580020
------	---	-----------

1758A

non-return funnel with quick coupling, Ø 38 mm For Volkswagen group cars



1758A	1	017580010
-------	---	-----------

1758B

non-return funnel with quick couplings Particularly suitable for VAG cars



1758B	1	017580030
-------	---	-----------

1758B-RNT

non-return quick coupling
for funnel item 1758B
for Renault 1.5 dCi engine



1758B-RNT 1 017580035

1758LG

formable, rubber-covered aluminium foil,
for canalizing liquids



L mm 365
H mm 168
1 017580006

1758M

funnel



L mm 350
1 017580000

1758R

liquid containers

Convenient, removable, flexible spout



1758R 3 3 1 017580203
1758R 5 5 1 017580205

1758VT

cylinder head testing kit

Quickly indicates whether expansion tank contains any
carbon dioxide.



1758VT 1 017580100

290x190x50 mm - 1 kg

1758VT/L

contrast liquid for testing cylinder heads



1758VT/L 1 017580101

1759

optical analyzer for coolant, battery,
windscreen and AdBlue® fluids
Supplied in a hard case

Automatic temperature compensation
Battery acid: measurement range:
1.1+1.3 kg/l
Propylene coolant: -25 °C + -50 °C
Ethylene coolant: -25 °C + -50 °C
Windscreen fluid: -25 °C + -40 °C
AdBlue: Urea percent measurement: 30% ± 45%



1759 1 017590251

1759A

antifreeze densimeter, glass body



L mm 340
1759A 1 017590001

1759B

acid densimeter, glass body



L mm 280
1759B 1 017590005

1759HD/3

cooling system seal testing and circuit filling
tools

• Make it possible to check circuit (pipes, joints, pumps,
radiators) for leaks under pressure and quickly fill circuit,
avoiding air bubble formation



1759HD/3 1 017590063

600x500x140 mm - 6,5 kg

1759HD/RR

cooling system filling tool



1759HD/RR

1 017590064

450x310x110 mm - 2,2 kg

1759HD/TRUCK

truck cooling system testing and sealing tool



1759HD/TRUCK

1 017590065

440x330x100 mm - 3 kg

1759TT

kit of 4 pairs of turbo circuit testing caps, for use with tyre inflators



1759TT

1 017590300

400x160x100 mm - 1,8 kg

1760DGT

digital automotive multimeter



TECHNICAL DATA

RPM (tachometer):
For 2 and 4 cylinder engines
RPM4 600 - 4000 RPM
RPM4 600 - 12000 RPM (x10 RPM)
RPM2/DIS 300 - 4000 RPM
RPM2/DIS 300 - 6000 RPM (x10 RPM)
Dwell angle: 4-8 CYL
DC voltage: 400mV-4/40/400/1000V
AC voltage: 4/40/400/700V
DC current: 40/400mA-4/20A
AC current: 40/400mA-4/20A
Resistance: 400Ω-4/40/400kΩ-4/40MΩ
Capacity: 40/400nF-4/40/100μF
Frequency: 5/50/500Hz-50/500-10MHz
Duty cycle: 0.1% - 99.9%
Pulse amplitude: 1 - 10ms
Diode test: Test current 0.3mA
Continuity: <150Ω - Test current <0.3mA
Display: High-contrast, backlit 4-digit LCD
Overvoltage: Category II 1000V
Auto power off: 30 minutes
Power supply: 1.9V battery (included)
Inductive clamp (included)
2 tips (included)
Soft cloth case (included)
Operating manual

1760DGT

1 017600005



1760DGT/2

digital automotive multimeter, portable, with 2-channel oscilloscope and waveform generator



KIT CONTENTS:

- multimeter tips
- 2 BNC crocodile clips for oscilloscope
- tip probe for oscilloscope (1X and 10X)
- battery charger
- nylon sheath

TECHNICAL DATA

Display: 2.8" colour TFT
Resolution: 320 x 240 pixels
Power supply: 100V-240V AC, 50Hz-60Hz; DC INPUT 5V DC-2A
Battery: 2 x 2600 mAh

MULTIMETER SPECIFICATIONS

Test: Voltage, Current, Resistance, Capacity, Diodes and On-Off
Max. voltage: 600V DC
Max. current: 10A DC
Max. resistance: 40MOHM
Max. capacity: 100μF

OSCILLOSCOPE SPECIFICATIONS

Horizontal
Bandwidth: 40MHz
Sampling frequency range: 250MSa/s (single channel) - 125MSa/s (double channel)
SEC/DIV range: 5ns/div ÷ 500s/div 1,2,5 sequence
Vertical
VOLTS/DIV range: 10mV/div÷10V/divat BNC input
Selectable analogue, bandwidth limit, typical: 20MHz
Low frequency response (-3db): ≤10Hz a BNC
DC Gain Accuracy: ± 3% for Normal or Medium acquisition mode, 10V/div ÷ 10 mV/div
Trigger
Type: Edge
Mode: Auto, Normal, Single
Slope: Rising, Falling, Rising, & Falling
Source: CH1, CH2
Input
Coupling: DC, AC or GND
Supported probe attenuation factors: 1X, 10X, 100X, 1000X
Arbitrary waveform generator
Waveform frequency: Sine (1Hz÷25MHz), Square (1Hz÷10MHz), Ramp (1Hz÷MHz), EXP (1Hz÷5MHz)
Width: 2.5Vpp (50Ω) - 5Vpp (high impedance)
Output impedance: 50Ω

Dimensions: 199 x 98 x 40 mm
Weight: 624g

1760DGT/2

1 017600008

1760B

digital multimeter

CE



SPECIFICATIONS

DC voltage: 200 mV-2/20/200/1000V
 AC voltage: 2-20/200/700V
 DC current: 2/20/200 mA-20 A
 AC current: 2/200 mA-20 A
 Resistance: 200Ω - 2/20/200 kΩ - 2/20 MΩ
 Capacity: 2/20/200 nF - 2/200 μF
 Temperature: -20° + 1000°C/ -4 °F ~ +2000°F
 Frequency: 20kHz
 Power supply: 1 9V battery (included)

1760B 1 017600012

1760/OHM

multimeter/megohmmeter for high voltage insulation testing.
 TRUE RMS indicator

CE

CAT. IV
 600V
 CAT. III
 1000V



Measuring range	Base accuracy	
AC/DC voltage: 50mV - 1000V	±0.06% - ±0.1% rdg	
AC/DC current: 0.01μA - 10A	±0.5% - ±1% rdg	
Resistance: 0.01Ω - 50MΩ	±0.2% - ±2% rdg	
Meg OHM: 0.01 - 5000MΩ	±4% rdg. max current	1mA
Capacity: 5nF - 10mF	±1.5% - ±3% rdg	
Frequency: 50Hz - 100 MHz	±0.02% - ±0.1% rdg	
Temperature: -50 °C - +1350 °C	±0.5% rdg	
Diode test: 3V dc		
Continuity test: <30 Ω		

1760/OHM 1 017600025

1760/RMS

industrial digital multimeter
 accurate and sturdy, in a 6-mm co-moulded shell, with antislip, shockproof outer rubber part

CE



Measuring range	Base accuracy
AC/DC voltage	110mV - 600V ±0.8% - ±2% rdg
AC/DC current	110μA - 10A ±1.5% - ±2% rdg
Resistance	110Ω - 40MΩ ±1.2% - ±2.5% rdg
Capacity to 11mF)	11nF - 40mF ±5% - ±10% rdg (up to 11mF)
Frequency	1100Hz - 110 MHz ±1.2% - ±1.5% rdg
Temperature	-32°C - +1000°C ±3% - ±5% rdg
Diode test, 3V DC ±10%	rdg
Continuity test	<30 Ω -

1760/RMS 1 017600020

1760PA/80

AC/DC amperometric clamp, 80A

Designed to measure low current leakage or absorption values on vehicles

CE



- Range: 1mA-80A AC/DC
- Torch function with white LED
- Backlit LCD display
- Zero setting function
- Hold function
- Auto power off
- Power supply: 2 1.5V AAA-type batteries

1760PA/80 1 017600002



1760PA/AC

amperometric clamp and digital multi-meter

A: AC
 V: AC/DC

CE



SPECIFICATIONS

DC voltage 400 mV - 4/40/400/600 V
 AC voltage 400 mV - 4/40/400/600 V
 AC current 40/400/1000 A
 Resistance 400Ω - 4/40/400 kΩ - 4/40 MΩ
 Frequency 5/50/500 Hz - 5/50/500 kHz - 5/10 MHz
 Capacity 40/400 nF - 4/40/100 μF
 Temperature -20 °C + 1000 °C / -4 °F + 1832 °F
 Power supply: 1 9V battery (included)

1760PA/AC 190 1 017600050

1760PA/AC-DC

amperometric clamp and digital multimeter

A: AC/DC
 V: AC/DC

CE



A: AC/DC
 V: AC/DC

SPECIFICATIONS

DC voltage: 0.1mV + 600V
 AC voltage: 0.1mV + 600V
 AC current: 0.01A + 1000A
 DC current: 0.01A + 1000A
 Resistance: 0.1Ω + 40MΩ
 Capacity: 0.001nF + 40 μF
 Frequency: 0.001kHz + 4kHz
 Temperature: -40°C + 1000 °C
 -40°F + 1832°F

1760PA/AC-DC 1 017600000

1760DGT-R3

spare leads for digital multimeters and amperometric clamps



1760DGT-R3

1 017600603

1760/RSE

signal detector

Allows power supply of parts to be tested, including common rail electro-injectors, petrol/LPG electro-injectors, piezoelectric injectors, flow regulating solenoid valves, EGR solenoid valves and coils



CE

Performing diagnosis of individual parts of electric system only requires probe to be brought near part being tested. In systems with electromechanical/electronic parts controlled by a control unit, this tool makes it possible to check whether:

- control unit is being supplied with power and is performing its control function
- cables connecting control unit to part is efficient
- part being tested has not being disconnected
- part has not short-circuited
- part is operating electronically

1760/RSE

1 017600170

1760/TC2

combination contact/non-contact digital tachometer



CE

TECHNICAL DATA

- For measuring:
 - non-contact rotational speed (rpm)
 - contact rotational (rpm) and linear surface speed (m/min or ft/min).
- 5-digit LCD display.
- Scale:
 - non-contact speed 2.5÷99,999 rpm
 - contact speed 0.5÷19,999 rpm
 - linear surface speed 0.05÷1,999.9 m/min.
- Frequency: 0.8 sec.
- Power supply: 4 1.5V batteries, AA size, or 6V power supply unit (not included).
- Supplied with the following:
 - adaptor for contact tip measurement;
 - male (contact) rubber tip (2 pcs.);
 - female (contact) rubber tip (1 pcs.);
 - linear measurement tape (1 pcs.);
 - reflecting tapes;
 - instruction manual;
 - plastic case.

1760/TC2 L 230 mm H 74 mm 1 017600161

1760R/TC2

set of reflecting tapes for item 1760/TC2



1760R/TC2

1 017600561

1760K

non-contact AC voltage detector with LED mini-torch

Testing range: 200-1000Vac 50/60Hz
CAT III-1000V
Requires 2 AAA batteries (included)



CE
CAT III-1000V

1760K

1 017600140

1760PT

combination voltage and continuity tester, 12-690V AC/DC

- Functions:
- continuity
 - phase rotation
 - mains testing
 - LED torch

CE

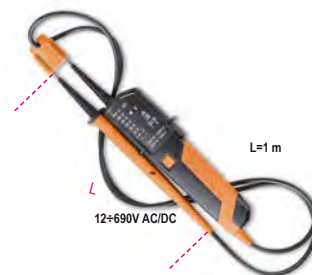

IP64
CATIV
- 600V ;
CATIII -
1000V

1760PT

1 017600150

1760/IR500

digital infrared thermometer with dual laser aiming system

not suitable for measuring body temperature



CE

TECHNICAL DATA

- Temperature range: -50 ÷ 500 °C (-22 ÷ +932 °F)
- Display resolution: 0.1 °C (0.1 °F)
- Emissivity: 0.1 ÷ 1 adjustable
- Accuracy: -50 °C ÷ +20 °C (+/- 3 °C); 20 ÷ 500 °C (+/-2% or 2 °C)
- Optical resolution (D:S): 12:1
- Auto power off: ca. 10 seconds
- Operating temperature: 0 °C ÷ 50 °C
- Storage temperature: -20 °C ÷ 60 °C
- Power supply: 1.9V battery

1760/IR500

1 017600350

Beta

Beta

1760/IR1000

digital infrared thermometer with dual laser aiming system

not suitable for measuring body temperature



TECHNICAL DATA

Temperature range: -50 °C + 1000 °C (-58 °F + 1832 °F)
Display resolution: 0.1 °C (0.1 °F)
Emissivity: 0.1 + 1 adjustable
Accuracy: -50 °C + 20 °C (+/- 3.5 °C); 20 °C + 300 °C (+/-1% or 1 °C); 300 °C + 1000 °C (+/-1.5%)
Optical resolution (D:S): 20:1
Operating temperature: 0 °C + 50 °C
Storage temperature: -10 °C + 60 °C
Power supply: 2 1.5V (AAA type batteries)

1760/IR1000 1 017600400

1760/IR1600

digital infrared thermometer with laser aiming system

not suitable for measuring body temperature



TECHNICAL DATA

Range: da -50 °C to +1600 °C / -58 °F to +2912 °F
Scale selection: °C/°F
Accuracy: ±1.5% or ±2 °C to 20 °C
Laser power: <1mW
Response: 1sec
Emissivity: 0.10-1.0 adjustable
Distance ratio: (D:S) 50:1
Operating temperature: 0 °C + 50 °C / 32 °F + 122 °F
Operating humidity: 10% to 90% RH
Backlit LCD display
Data storage function
Auto power off
Power supply: 1 9V battery (included)
Hard case with aluminium tripod
Operating manual

1760/IR1600 200 mm 115 mm 1 017600461

1760TMC

infrared thermal camera

compact thermal camera for contactless temperature measurement, suitable for applications in building, mechanical, electric installation and heating industries

LCD TFT display, 2", 240x320
sensor, 32x32 pixels
acquisition frequency 7Hz
thermal sensitivity <347mK
automatic acquisition of hot and cold spots
camera for acquisition of images in BMP format (max. 100 images)
adjustable emissivity
power supply: 3 alkaline AAA batteries
USB interface
IP54
temperature range: -20 °C + +600 °C
infrared band: 6.5+14µm
visible/infrared image fusion: 0.5; 1; 2m
alarm function, selecting acceptable maximum and minimum temperatures



1760TMC 600 1 017600710

1761

wire twisting pliers with automatic return



L mm 255 1 017610101

1761RS/1

reversible wire twisting pliers with automatic return



L mm 220 1 017610130

1762

revolving punch pliers



1763

car upholstery clip pliers



1763 1 017630001

1763G/S500

500 car upholstery clips



1763G/S500 1 017630105

1765/C24

cases with 24 tools for pulling out car radios



1765/C24 1 017650001

1766

double suction lifter



max kg 50 2 017660001

1766A

single suction cup



max
kg
30

2 017660005

1766/8

assortment of 8 tools
for car glass windows



1766/8

1 017660100

1766ER

window trim removal tool
with handle

Allows window trims to be easily removed,
with no risk of damage



1766ER

1 017660501

1766L

lever for glass windows



1766L

1 017660015

1766LI

lever for inserting car glass window cutting
cable
sharp edges for cutting bonds



1766LI

1 017660016

1766I

handle for steel cable item 1766G

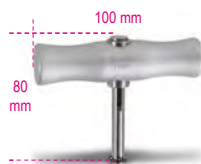

1766I

2 017660020

1766G

steel cable for car windows

Square section



50 m

1 017660025

1766T

steel cable for glass windows

triangular section



50 m

1 017660026

1767A

telescopic rod

- designed to support bonnets and tailgates with decompressed pistons.
- can be used to keep pedals from moving.



L
mm
640 ÷ 1090

1 017670000

1767PMC

magnetic tool holder, round



1767PMC

1 017670020

1767PMR

magnetic tool holder, rectangular



1767PMR

1 017670010

1770

extra flat utility knife,
9 mm snap-off blade



L mm
A mm
1770 140 9

10 017700001

1770A

utility knife 9 mm with automatic blade locking mechanism, 3 blades



1770A	L mm	A mm	10	017700025
	135	9		

1770RL

9 mm snap-off blades 10 pieces for utility knives 1770, 1770BM and 1770A



1770RL	5	017700010
--------	---	-----------

1770BM

utility knife, 9 mm, 6 blades



1770BM	L mm	A mm	10	017700050
	140	9		

1771

utility knife, 18 mm, supplied with 3 blades



1771	10	017710000
------	----	-----------

1771BM

utility knife, 18 mm, 6 spare blades



1771BM	L mm	A mm	10	017710050
	170	18		

1771HD

utility knife, 18 mm, supplied with 6 blades
•automatic blade change
•screw blade locking system



1771HD	L mm	A mm	5	017710100
	190	18		

1771RL

18 mm snap-off spare blades (10 pieces) for utility knives 1771, 1771BM, 1771HD



1771RL	5	017710010
--------	---	-----------

1772M

safety utility knife with retractable blade, supplied with 3 blades

blade retracts through an automatic spring mechanism
• die-cast alloy body
• staple remover built into handle



1772M	L mm	A mm	5	017720040
	170	18		

1772R

utility knife with retractable trapezoidal blade, supplied with 5 blades



1772R	L mm	A mm	5	017720006
	125	18		

1772H

safety utility knife with retractable blade, supplied with 2 blades



1772H	L mm	A mm	5	017720029
	170	18		

1772RL/2

10 long trapezoidal spare blades, in box, for utility knives, 1772H, 1772M, 1772R, 1774, 1777BMT, 1777T

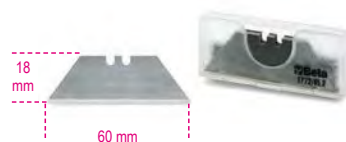

1772RL/2	5	017720017
----------	---	-----------

1773A

utility knife, 25 mm



1773A	L mm	A mm	10	017730000
	180	25		

1773RL

25 mm blades (10 pieces) for utility knife 1773A



1773RL	5	017730015
--------	---	-----------

1774

multi-function scraper with blade guard



1774	L mm	L1 mm	5	017740001
	155	60		

1774A

multifunction scraper, bi-material handle



1774A	L mm	A mm	1	017740011
	300	40		

1774A/RL

10 blades for scrapers 1774A and 1774S

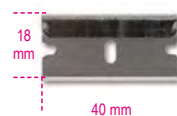

1774A/RL	1	017740511
----------	---	-----------

1774S

sticker removal scrapers



1774S	A mm	L mm	1	017740021
	40	100		

1777BM

foldaway knife with wire stripping notch, stainless steel blade



	L	L1	A		
1777BM	mm	mm	mm	5	017770100
	190	80	16		

1777T

foldaway knife with trapezoidal stainless steel blade, 5 spare blades



	L	A	L1		
1777T	mm	mm	mm	5	017770030
	160	19	65		

1777BMT

foldaway knife with trapezoidal blade 4 adjustable blade depths 4; 9.5; 15.5; 21.5 mm supplied with 3 blades

NOT AVAILABLE IN THE UK, IRELAND AND USA



	L	L1	A		
1777BMT	mm	mm	mm	5	017770050
	170	80	19		

1778AX

foldaway knife, stainless steel serrated blade, aluminium handle, serration pattern for easier opening • in case



	L	A	L1		
1778AX	mm	mm	mm	5	017780026
	189	26	80		

1778CM

camouflage foldaway knife, hardened steel blade, in case



	L	A	L1		
1778CM	mm	mm	mm	5	017780099
	195	24	80		

1778D

foldaway knife, stainless steel blade and handle, in case



	L	A	L1		
1778D	mm	mm	mm	5	017780060
	180	22	78		

1778P

foldaway knife, stainless steel and aluminium blade and handle, with push button opening mechanism • in case



	L	A	L1		
1778P	mm	mm	mm	5	017780088
	193	29	72		

1778SCL

foldaway knife with soft carbon look finish, hardened steel blade, in case



	L	A	L1		
1778SCL	mm	mm	mm	5	017780089
	180	22	78		

1778SOS

car service knife with window breaking hammer and seat belt cutter features in case



	L	A	L1		
1778SOS	mm	mm	mm	5	017780080
	205	25	85		

1778U

foldaway knife, hardened steel blade • in case



	L	A	L1		
1778U	mm	mm	mm	5	017780070
	195	24	80		

1778V18

foldaway knife, aluminium handle • in case



	L	A	L1		
1778V18	mm	mm	mm	5	017780018
	195	25	85		

1778X

knives for nautical maintenance, stainless steel blades, aluminium handles in case



	L	L1	A		
1778X	mm	mm	mm	2	017780050
	185	85	25		

1781
slim, long blade scissors



L	mm		
1781	132	2	017810001

1783
light duty scissors



L	mm		
1783	215	5	017830021
	240	5	017830024

1784
heavy duty scissors



L	mm		
1784	175	2	017840017
	200	2	017840020
	250	2	017840025
	300	2	017840030

1800/100
lifting airbags (max. lifting force: 100 kg)

- lifting/levelling
- locking doors



A	B	S	
mm	mm	mm	
1800	150	2÷55	3 018000000

1808
dual rating soldering iron with steel tips
1824R8



W	V		
20/130	230	1	018080001

1812 150
instant heat soldering iron

CE



230V
L=1,25 m Euro

W	V		
1812	150	230	1 018120015

1814M
soldering irons
with steel tips

CE



L=1,2 m
230V
Schuko

W	V		
1814M	25	230	1 018140225
	30	230	1 018140230
	40	230	1 018140240

1820
soldering irons

CE



L=1,25 m
230V
Shuko

1820	30W	L = 210mm	1 018200003
1820	60W	L = 220mm	1 018200006
1820	80W	L = 260mm	1 018200008

1822
high-performance soldering irons

CE



230V
Shuko
L=1,25 m

1822	120W	LxA = 250x125 mm	1 018220012
1822	180W	LxA = 250x125 mm	1 018220018
1822	320W	LxA = 250x140 mm	1 018220032

1823 60
digital soldering station
supplied with soldering iron

- Temperature range: 160 °C ÷ 480 °C with ±1% accuracy.
- Memory mode designed to save the temperature selected when switching off the station.
- 3 quick selection keys (200-300-400 °C).

CE



W	V		
1823	60		1 018230060

1823R/60
spare soldering iron for item 1823 60

CE



1823R	60W	24V	1 018230066
-------	-----	-----	-------------

1824R
spare tips for soldering irons



1824R	08	1808	1 018240100
1824R	12	1812/150	1 018240301
1824R	14-M25	1814M/25	1 018240152
1824R	14-M30	1814M/30	1 018240153
1824R	14-M40	1814M/40	1 018240154
1824R	20	1820/30	1 018240302
1824R	60	1820/60	1 018240303
1824R	80	1820/80	1 018240304
1824R	120-180	1822/120 -/180	1 018240305
1824R	320	1822/320	1 018240307
1824R	ST-60	1823-60	1 018240308

1825B
soldering tin wire with antioxidant

- 1 mm²; 250 g
- Sn 99.3%; Cu 0.7%



1825B			1 018250251
-------	--	--	-------------

1827

gas soldering iron, adjustable



1827 1 018270001

1827PC

spare conical tips for item 1827

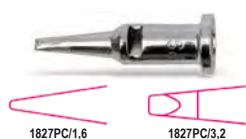

1827PC 1,6 1 018270501
1827PC 3,2 1 018270502

1827PCL

spare knife tips for item 1827



1827PCL 2,4 1 018270503

1827PFL

spare naked flame tips for item 1827



1827PFL 1 018270504

1827/K

gas soldering iron with 7 accessories in case with soft polyethylene foam base



- Power: 30 watts to 125 watts
- Tip temperature can be adjusted between 250 °C and 500 °C
- Gas flow regulator
- Warm-up time: 15 seconds
- Tank contains gas for 120 minutes' non-stop operation
- Clear tank for monitoring gas level
- Can be refilled with butane gas

1827/K 1 018270100

1827F

butane gas soldering iron

35 g tank

- three interchangeable nozzles: 550 °C; 1000 °C; 1300 °C
- supplied with a stand in hard case



1827F 1 018270200

1830T

dissoldering pipe with antistatic plastic (PTFE) nozzle



L mm 190 5 018300021

1833L/USB

high-brightness LED torch, made of sturdy anodized aluminium, up to 1,200 lumens

- adjustable focus
- 3 brightness settings
- battery life: 3.0 h
- IP66
- flat battery indicator (<15%)
- USB-C charging
- charger not included



L mm 240 1 018330054

1833RB-L/USB

spare battery for item 1833L/USB

1833RB-L/USB 1 018330975

1833XS/1

LED inspection torch, made of sturdy anodized aluminium

- 100 lumens
- adjustable focus
- batteries: 1xAAA (not included)
- battery life: 5.0 h
- IP66



L mm 92 3 018330000

1833XS/2

LED inspection torch, made of sturdy anodized aluminium

- 200 lumens
- adjustable focus
- batteries: 2xAAA (not included)
- battery life: 10.0 h
- IP66



L mm 133 3 018330001

1833S

high-brightness LED torch, made of sturdy anodized aluminium, up to 500 lumens

- adjustable focus
- 2 brightness settings
- batteries: 2xAA (not included)
- battery life: 10.0 h
- IP66



L mm 150 1 018330002

Beta
Quality Tools

1833M

high-brightness LED torch,
made of sturdy anodized aluminium,
up to 700 lumens

- adjustable focus
- 2 brightness settings
- batteries: 3xAAA (not included)
- battery life: 7.5 h
- IP66



L
mm
162  1 018330003

1833L

high-brightness LED torch,
made of sturdy anodized aluminium,
up to 1,100 lumens

- adjustable focus
- 2 brightness settings
- batteries: 3xAAA (not included)
- battery life: 8.5 h
- IP66



L
mm
196  1 018330004

1833XL

high-brightness LED torch,
made of sturdy anodized aluminium,
up to 1,500 lumens

- adjustable focus
- 2 brightness settings
- batteries: 3xD (not included)
- battery life: 22.0 h
- IP66



L
mm
300  1 018330005

1834RR

LED torch,
rechargeable in cigarette lighter socket

- Adjustable focus
- Rechargeable in cigarette lighter socket, 10-28V DC
- IP30
- 130 lumens



1834RR  1 018340520

1836A

LED headlamp, dual brightness, with
contactless ON/OFF sensor

- 120/65 lumens
- IP54
- Batteries: 3xAAA included



1836A  1 018360050

1836B

rechargeable LED headlamp, dual brightness,
with ON/OFF sensor

- Contactless ON/OFF sensor
- 250 lumens
- Life: 3-6 h
- IP65



1836B  1 018360200

1837C

rechargeable LED spotlight for building yards

- 3 brightness settings
- battery charger: input: 100-240V AC - 50/60Hz; output: 15V 1.5A
- charging time: 4 hours
- 3-LED charge indicator
- can rotate up to 180°
- IP65
- IK07
- with applicable magnetic base



LxHxI mm	Lm	h	
220x225x70	2100	2.5	1 018370210
	1000	5.0	
	500	9.0	
266x236.6x59	4300	1.5	1 018370430
	2100	3.0	
	1100	6.0	

1837F

magnetic, articulated lamp with high-
brightness LEDs,
made of sturdy anodized aluminium,
up to 500 lumens

- adjustable focus
- 2 brightness settings
- batteries: 3xAA (not included)
- battery life: 14.5 h
- charge indicator
- IP66



L
mm
460  1 018370050

1837F/USB

rechargeable, magnetic, articulated lamp with
high-brightness LEDs,
made of sturdy anodized aluminium,
up to 600 lumens

- adjustable focus
- 2 brightness settings
- battery life: 10.0 h
- USB-C charging
- IP66



L
mm
460  1 018370060

1837RB-F/USB

spare battery for item 1837F/USB

1837RB-F/USB  1 018370960

1837M

rechargeable LED COLOUR MATCH spotlight, for visual colour control, high colour rendering index (CRI 96+), up to 2,000 lumens

- 3 brightness settings: 500/1,000/2,000 lumens
- CRI (colour rendering index): 96+
- CCT (correlated colour temperature): 2700K/ 3500K/ 4500K/ 5500K/ 6500K
- battery charger: input: 100-240V AC - 50/60Hz; output: 15V 1.5A
- quick release charge connector
- charging time: 3.5 hours
- battery life: 8/4/2 h
- charge indicator
- button and LED colour temperature indicator
- button and LED brightness indicator
- can rotate up to 180°
- IP65
- IK07



LxHxI mm	Lm	h	
220x225x70	500	8.0	1 018370450
	1000	4.0	
	2000	2.0	

1837S

telescoping tripod for worklight

- made of metal
- adjustable height: 70÷155 cm
- compatible with items 1837C and 1838FLASH



h cm	
70÷170	1 018370500

1838/11LED

rechargeable inspection lamp with ultra-high brightness LEDs, lithium polymer battery

- Compact body made of antislip rubber
- Easy-to-replace front glass
- Swinging hook
- With charging station, 110-230Vac
- 320 lumens
- With multidirectional head LED



1838/11LED 1 018380111

1838RA/10-11LED

spare power supplies for items 1838/10LED and 1838/11LED

1838RA/10-11LED 1 018380903

1838RB/10LED

spare battery for items 1838/10LED and 1838/11LED

1838RB/10LED 1 018380902

1838RR/11LED

charging bases for item 1838/11LED

1838RR/11LED 1 018380914

1838RV/11LED

spare scratch-proof glass for lamp 1838/11LED



1838RV/11LED 2 018380905

1838COB

portable rechargeable LED inspection lamp

- with hanging hook and antislip, shockproof body
- lithium polymer battery
- 100/200 lumens SPOT 75 lumens



1838COB 1 018380010

1838P

rechargeable inspection pen light, with double light emission: lamp and torch

- Compact body made of non-slip rubber
- 50/80 lumens
- Pocket hook
- Magnetic base can be rotated 180 degrees
- Complete with USB/jack charging cable, 3.5mm
- Life: 2.5 hours
- IP20



1838P 1 018380005

1838FLASH

rechargeable, ultracompact spotlight, designed to offer the best possible solution for each use

ABUNDANT READY LIGHTING: with a maximum lighting capacity of 720 lumens, and running on both battery and cable, it is always ready to use.

CAN BE PLACED ANYWHERE:

-on flat surfaces: with rubber feet on three sides or 1/4" drive for stands (camera-like standard)

-on metal structures: with unscrewable magnet or hook that can be rotated 360 degrees.

COMPACT: no more than 85x100x155 mm in size, it can be easily replaced in tool bag and used in small areas.

STURDY: designed to withstand extremely severe mechanical stress. Guaranteed durability.



IP65

1838FLASH 1 018380300

1838RB/FLASH

spare battery for item 1838/FLASH

1838RB/FLASH 1 018380930

Beta

Beta
Quality Tools

1838SL

ultra-thin inspection lamp with ultra-high brightness LEDs.

For jobs in small areas

- power supply: 12V, with lighter socket and battery terminals
- 2.5-m-long cable
- thickness: 6mm
- 345 lumens

CE



1838SL 1 018380101

1838SLIM

rechargeable, articulated slim 3-LED inspection lamp

- triple light emission
- front: 100/200 lumens/ back: 180 lumens/ spot (head): 80 lumens
- magnetic base
- charging time: 2.5h
- battery life: 2-4h/ spot 3h

CE

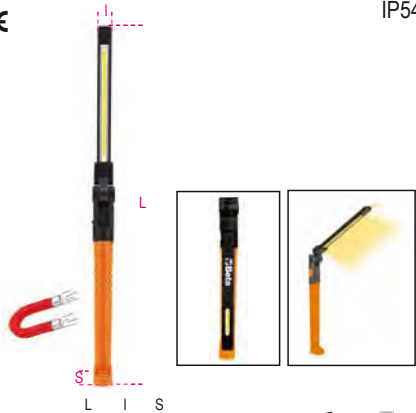

IP54

1838SLIM 307 17 29 1 018380221

1838S

rechargeable, articulated LED inspection lamp

- can be rotated 180°
- dual light emission, front and spot (head)
- 700 lumens / spot 200 lumens
- nonslip rubber body
- double swinging hook
- magnets on base and back for increased adjustability
- complete with charger (100-240V / 50-60Hz)
- charging time: 4h
- battery life: 2-7.5 h
- dual light emission
- front: 150/300/700 lumens/ spot (head): 200 lumens

CE



IP65

1838S 260 52 38 1 018380122

1838UV

rechargeable UV and white light inspection lamp

ideal for detecting leaks

- Compact body made of antislip rubber
- With charger 100-240Vac / 50-60Hz
- 150 lumens / UV

CE



1838UV 1 018380150

1839/R1

transformer with USB output, spare part for items 1834L/USB; 1836B; 1837/USB; 1838COB

1839/R1 1 018390501

1839/R2

USB/jack cable 3.5 mm, spare part for items 1836B; 1838P; 1838COB

1839/R2 1 018390502

1839/R4

USB/USB-C cable, spare part for items 1833L/USB; 1833F/USB; 1838SLIM; 1838S

1839/R4 1 018390504

1840BM

230V inspection lamp, base type: E27

- Bulb not included

CE



IP20

1840BM 230 60 420 1 018400101

1842LED/BM

lamp with ultra-high brightness LEDs, 100-240 Vac

- 10-m-long cable
- compact body made of antislip rubber
- easy-to-replace front glass
- swinging hook
- 340 lumens
- with multi-directional head LED light

CE



IP65

1842LED/BM 1 018420301

1842LED/ABM

lamp with ultra-high brightness LEDs, 12-24V AC/DC

- 10-m-long cable
- compact body made of antislip rubber
- easy-to-replace front glass
- swinging hook
- 320 lumens
- with multi-directional head LED light

CE



IP65

1842LED/ABM 1 018420311

1843BM

automatic cable reel with 230 Vac inspection lamp, base type E27 and steel protector

- Bulb not included

CE



IP42
IP20

1843BM 1 018430101

1843R/BM

spare inspection lamp for cable reels, base type E27

- Bulb not included

CE



IP20

1843R/BM

1 018430131

1846LED/BM

Automatic cable reel with LED inspection lamp, 100-240 Vac

- With 230/24V safety transformer
- Max. 25 W

CE



IP42
IP65

1846LED/BM

1 018460301

1846LED/ABM

Automatic cable reel with LED inspection lamp, 12-24V AC/DC

- Max. 60 W

CE



IP42
IP65

1846LED/ABM

1 018460311

1846R-LED/BM

spare LED lamps
12-24V - AC-DC



1846LED/BM R

1 018460331

1848

automatic cable reel with Schuko type socket

- Crush-resistant rubber cable H07 - 3x1.5 mm² - 15m
- Max. 1600 W with unwound cable
- Max. 1200 W with wound cable

CE



IP42

L=15 m

1848

1 018480015

1850B

heat gun

- Pos. I 240 l/min. 300° C
- Pos. II 450 l/min. 500° C
- can be used with gun placed vertically on worktop

CE



1600W
300÷500 C°

230V
Schuko

L=2,4 m

1850B

L mm 240
H mm 190

1 018500011

1850C

heat gun

- Pos. I 150-250 l/min 50°C
- Pos. II 150-500 l/min 50-650°C

- digital display
- buttons designed to adjust temperature and flow capacity
- can be used with gun placed vertically on a worktop
- 4 preset programmes and possibility to customize other programmes

- Prog 1 250°C ca. 350 l/min
- Prog 2 350°C ca. 400 l/min
- Prog 3 450°C ca. 500 l/min
- Prog 4 550°C ca. 400 l/min

CE



2000W
50÷650 C°

L=2,4 m

230V
Schuko

1850C

L mm 255
H mm 210

1 018500015

1850U...

nozzles for items 1850B and 1850C

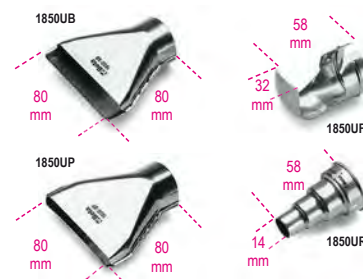

1850UB	1850 B-C	1	018500100
1850UF	B-C	1	018500101
1850UP	B-C	1	018500102
1850UR	C	1	018500103

1851VK

hot glue gun with 12 thermofusible glue sticks in case

CE



1851VK

320x250x50 mm

1 018510058

1851VK-12C

12 thermofusible glue sticks
Ø 11 mm



1851VK-12C

1 018510062

1851VK-12V

12 thermofusible glue sticks
for painted surfaces
Ø 11 mm



1851VK-12V

1 018510072

1852R1750

portable induction heater

CE



- heats and loosens bolts, hubs and bearings without using flames
- allows any type of ferromagnetic metal to be heated

Standard equipment:

- two front attachable coils, Ø 19 and 26 mm, for loosening nuts
- one flat coil for heating surfaces
- one flexible coil, 800 mm long
- supplied in plastic case

Technical data:

- input voltage: 230V AC, 50/60 Hz
- input current: max. 7,5A
- power: max. 1.75 kW

OPTIONAL EQUIPMENT

Coils are also available in other sizes

BENEFITS

- Time saving: quick, extremely accurate heating
- Fire safety: does not produce flames, maximum operator safety
- Functional: can be used with one hand, and coils can be easily interchanged

FIELDS OF APPLICATION

- Automotive industry
- Industrial maintenance
- Aviation industry
- Naval industry
- Petrochemical industry

1852R1750

1 018520175

480x370x130 mm - 4,5 kg

1852S-L

side attachable coils



	Ø	M	L		
	mm	M	mm		
1852S-L 19	19	M6	220	1	018520501
1852S-L 20	20	M8	220	1	018520502
1852S-L 23	23	M10	220	1	018520503
1852S-L 26	26	M12	220	1	018520504
1852S-L 32	32	M16	220	1	018520505
1852S-L 38	38	M20	220	1	018520506
1852S-L 45	45	M22	220	1	018520507

1852S-F

front attachable coil



	Ø	M	L		
	mm	M	mm		
1852S-F 19	19	M6	220	1	018520508
1852S-F 20	20	M8	220	1	018520509
1852S-F 23	23	M10	220	1	018520510
1852S-F 26	26	M12	220	1	018520511
1852S-F 32	32	M16	220	1	018520512
1852S-F 38	38	M20	220	1	018520513
1852S-F 45	45	M22	220	1	018520514

1852S-FLESS

flexible coil



1852S-FL 800	1	018520515
1852S-FL1000	1	018520517
1852S-FL1500	1	018520518

1852 S-PIATTE

flat coil



1852S-PIATTE	1	018520516
--------------	---	-----------

1860 140A

DC inverter welding machine for MMA and TIG electrode steel welding.

Compact and easy to carry

Arc force, hotstart, anti-sticking and thermostatic protection features

Adjustment current: 5÷140A
Power supply: 1x230V

Use factor (40 °C) :

- 25% - 140 A
- 60% - 100 A
- 100% - 90 A

Delayed fuse: 16 A

Protection: IP23S

Usable electrodes: Ø 1.5- 4mm rutilic, basic, stainless steel, cast iron etc.

supplied with 16mm² cables



1860 140A	1	018600004
-----------	---	-----------

1860 160A

DC inverter welding machine for MMA and TIG electrode steel welding.

Compact and easy to carry

Arc force, hotstart, anti-sticking and thermostatic protection features

Adjustment current: 5÷160A
Power supply: 1x230V

Use factor (40 °C) :

- 30% - 160 A
- 60% - 1030 A
- 100% - 110 A

Delayed fuse: 25 A

Protection: IP23S

Usable electrodes: Ø 1.5 - 4mm rutilic, basic, stainless steel, cast iron etc.

Supplied with 25mm² cables



1860 160A	1	018600006
-----------	---	-----------

1860RC

spare cables for inverter welding machines item 1860

electrode holder cable length: 2.5m
earth cable length: 1.8m



1860RC/140A	1	018600604
1860RC/160A	1	018600606

1860EI

magnetic square, 90°, for interior and exterior angles

Ideal for locking tubular or flat parts, 18 kg magnetic force, with bevels for 30° and 60° angles, with hexagon hole making it easier to separate magnet from metal



	L	L1	S		
	mm	mm	mm		
1860EI	165	110	35	1	018600290

Beta

Beta
Quality Tools

1860RG

adjustable magnetic square, 30°+270°

Ideal for locking tubular or flat parts,
15 kg magnetic force,
supplied with an offset hexagon key wrench for locking angle
adjustment mechanism,
supplied with a pin for locking angle adjustment mechanism
at 30°-45°-90°/270°-180°
with hexagon hole making it easier to separate magnet from
metal



	L mm	S mm		
1860RG	155	35	1	018600255

1860SQ

magnetic square, 45°/90°

ideal for locking tubular or flat parts
27 kg magnetic force
no battery required, ON/OFF effect obtained by tilting interior
magnets
easier chip removal with magnets in OFF position



1860SQ			1	018600210

7041LCD/4S

auto-darkening LCD mask, for electrode
welding; MIG/MAG; TIG and plasma.

4 sensors
with TRUE COLOR filter
solar cell power supply and lithium batteries
for outstanding LCD filter life

- Viewing area: 98x80 mm
- Darkening shade range: 5÷8.5/ 9-13, internally adjustable
- UV/IR protection: DIN16
- Light to dark time: 1/25000 s
- Dark to light time: 0.1-2.0s
- Adjustable darkening sensitivity and delay
- Auto on/off
- Grinding feature
- Low battery indicator
- Ergonomic design, lightweight, well-balanced
- With adjustable ring nut



CE



7041LCD/4S			1	070410001

7041LCD/4S-VE

scratch-proof lens protector for item
7041LCD/4S

7041LCD/4S-VE			2	070410101

7041LCD/4S-VI

inside lens for item 7041LCD/4S

7041LCD/4S-VI			2	070410102

7042LCD

Auto-darkening LCD mask, for electrode
welding; MIG/MAG; TIG and plasma.
Solar cells power supply and lithium batteries
for outstanding LCD filter life

- Viewing area: 98x43 mm
- Darkening shade: DIN 9-13, externally adjustable
- UV/IR protection
- Light to dark time: 1/25000 s
- Dark to light time: 0.25-1s
- Adjustable darkening sensitivity and delay
- Auto on/off
- Grinding feature
- Optimized shape to make it easier to breathe with pulled-down
screen



CE



7042LCD			1	070420001

7042LCD/RV

scratch-proof lens protector for item 7042LCD,
7043

7042LCD/RV			2	070420101

7042LCD/RV-INT

inside lens for item 7042LCD, 7043

7042LCD/RV-INT			2	070420102



7043

auto-darkening LCD mask, for electrode
welding, MIG/MAG, TIG and plasma,
solar cell power supply

- viewing area: 92x43 mm
- darkening shade: DIN 9-13, externally adjustable
- UV/IR protection
- light to dark time: 1/1000 s
- dark to light time: 0.1-1.0 s
- adjustable darkening delay
- auto on/off
- grinding feature
- optimized shape to make it easier to breathe with pulled-down
screen

CE



7043			1	070430001

1870

solid and fluid vacuum cleaner, 20 l

- single-stage by-pass motor
- voltage: 230/240 V
- frequency: 50/60 Hz
- max. power: 1200 W
- airflow rate: 58 l/sec.
- max. suction power: 190 mbar
- max. drum capacity: 20 l, made of antistatic PP
- acoustic emissions: <70 dB(A)
- cable length: 5 m
- trolley for accessories
- STANDARD ACCESSORIES, Ø 36 mm
- 1 corrugated hose with ergonomic handle
- 2 hard extension tubes
- 1 multiuse brush for floors and fluids
- 1 flat nozzle
- FILTERING SYSTEMS
- 1 surface filter cartridge 1900 cm² - 12 µm nom.
- 1 anti-foam filter PPI 45/PPI 30

CE



IPX4

1870			1	018700020

1871M

solid and fluid vacuum cleaner, 35 l,
with service power and compressed air outlets

- automatic filter cleaning
- two-stage by-pass motor
- voltage: 230/240 V
- max. power: 1200 W
- max. service outlet power: 2000 W
- max. pneumatic tool connection: 15 bar
- airflow rate: 60 l/sec.
- max. suction power: 220 mbar
- max. drum capacity: 35 l, made of antistatic PE-HD
- acoustic emissions: <68 dB(A)
- cable length: 7 m

STANDARD ACCESSORIES

- 1 corrugated hose with ergonomic handle
- 2 plastic extension tubes
- 1 combined brush frame
- 1 section with fluid collection hoses
- 1 flat nozzle
- 1 rubber fitting for tool connection; inside Ø: 26 mm
- 6 air pipe locks, with suction pipe

FILTERING SYSTEMS

- paper bag; IFA class: "M"
- filter cartridge; IFA class: "M"
- anti-foam filter PPI 45/PPI 30

CE



1871M

1 018710035

1871M/AS

solid and fluid vacuum cleaner, 35 l,
with service power and compressed air outlets,
class "M" certified

- automatic filter cleaning
- two-stage by-pass motor
- voltage: 230/240 V
- max. power: 1200 W
- max. service outlet power: 2000 W
- max. pneumatic tool connection pressure: 15 bar
- airflow rate: 60 l/sec.
- max. suction power: 220 mbar
- max. drum capacity: 35 l, made of antistatic PE-HD
- acoustic emissions: <68 dB(A)
- cable length: 7 m

STANDARD ACCESSORIES

- 1 corrugated hose

CE



1871M/AS

1 018710135

1872L

solid and fluid vacuum cleaner, 35 l
"L" class certified

- two-stage by-pass motor
- voltage: 230/240 V
- frequency: 50/60 Hz
- max. power: 1100 W
- airflow rate: 55 l/sec.
- max. suction power: 220 mbar
- max. drum capacity: 35 l, made of antistatic PE-HD
- acoustic emissions: <68 dB(A)
- cable length: 6 m

STANDARD ACCESSORIES, Ø 36 mm

- 1 corrugated hose with ergonomic handle
- 2 plastic extension tubes
- 1 combined brush frameQ
- 1 section with fluid collection hoses
- 1 flat nozzle

FILTERING SYSTEMS

- 1 disposable fabric bag; filtration class: "L"
- 1 filter cartridge; IFA class: "L"
- 1 anti-foam filter PPI 45/PPI 30
- 2 post-filters made of PP-laminated PET

CE



IPX4

1872L

1 018720135

1873

solid and vacuum cleaner, 30 l,
stainless steel drum

- two-stage by-pass motor • voltage: 230/240 V
 - frequency: 50/60 Hz • max. power: 1100 W
 - airflow rate: 55l/sec. • max. suction pressure: 220 mbar
 - max. drum capacity: 30 l, made of stainless steel
 - acoustic emissions: <61 dB(A)
 - cable length: 6 m • trolley for accessories
- ### STANDARD ACCESSORIES, Ø 45 mm
- 1 corrugated hose with ergonomic handle
 - 2 stainless steel extension tubes
 - 1 industrial brush frame
 - 1 industrial section for carpets
 - 1 industrial section with fluid collection hoses
 - 1 flat nozzle

FILTERING SYSTEMS

- 1 filter paper bag
- 1 surface filter cartridge 1900 cm², 12 µm nom.
- 1 anti-foam filter PPI 45/PPI 30

CE



1873 30

1 018730030

1874

solid and fluid vacuum cleaner, 50 l,
stainless steel drum

- two-stage by-pass motor • voltage: 230/240 V
 - frequency: 50/60 Hz
 - max. power: 1350 W
 - airflow rate: 55 l/sec.
 - max. suction pressure: 240 mbar
 - max. drum capacity: 50 l, made of stainless steel
 - acoustic emissions: <63 dB(A)
 - cable length: 6 m
 - trolley for accessories
- ### STANDARD ACCESSORIES, Ø 45 mm
- 1 corrugated hose with ergonomic handle
 - 2 stainless steel extension tubes
 - 1 industrial brush frame
 - 1 industrial section for carpets
 - 1 industrial section with fluid collection hoses
 - 1 flat nozzle
- ### FILTERING SYSTEMS
- 1 filter bag
 - 1 surface filter cartridge 5200 cm², 12 µm nom.
 - 1 anti-foam filter PPI 45/PPI 30

CE



1874 50

1 018740050

1870-20/5S

5 horizontal paper bags for item 1870



1870 20/5S

1 018700021

1870-72 /FC

cartridge filter 1900 cm² 12 - µm nom.
for items 1870 - 1872 - 1873



1870-72 /FC

1 018700026

1870-72/FL

fluid vacuum cleaning filter
for items 1870 - 1872 - 1873 - 1874



1870 72/FL

1 018700027

1872L 35/FC

cartridge filter, "L" class,
for item 1872L 35



1872L 35/FC

1 018720144

1872L 35/5S

5 disposable fabric bags, "L" class



1872L 35/5S

1 018720136

1873-30/5S

5 vertical paper bags for item 1873



1873 30/5S

1 018730031

1874-50/5S

5 vertical bags for item 1874



1874 50/5S

1 018740051

1874-50/FC

cartridge filter 5200 cm² - 12 µm nom.
for item 1874



1874 50/FC

1 018740056

1877

exhausted oil drain unit, wheeled,
with 90 l tank

- level indicator
- big diameter pan with breakwater grate; capacity: 12 l
- pneumatic tank emptying through 1.8 m pipe
- tool tray

CE



1877

1 018770008

1877A

exhausted oil drain unit / vacuum cleaner,
wheeled,
with 90 l tank and pre-chamber

- level indicator
- big diameter pan with breakwater grate; capacity: 12 l
- transparent pre-chamber: capacity 9.5 l
- 1.8 m suction pipe
- pneumatic tank emptying through 1.8 m pipe
- tool tray

Standard accessories:

- 1 hard probe, Ø 5x700 mm
- 1 flexible probe, Ø 5x700 mm
- 1 hard probe, Ø 6x600 mm
- 1 flexible probe, Ø 6x700 mm
- 1 flexible probe, Ø 7x700 mm
- 1 flexible probe, Ø 8x700 mm
- adapters for VW, BMW, CITROËN

CE



1877A

1 018770080

1878 2

fluid collection tank

- maximum capacity: 2 l
- particularly suitable for changing oil in scooters



1878 2

2 l
H mm
85

1 018780002

1878 3

oil collection tank,
for truck hubs
With oil drip catcher



1878 3

3 l

1 018780003

1878 4

fluid collection tank,
portable

- suitable for motorcycles
- maximum capacity: 4 l
- reduced splashing



1878 4

4 l
H mm
100

1 018780004

1878 8

fluid collection tank

- height suitable for motorcycles
- maximum capacity: 8 l



1878 8

8 l
H mm
110

1 018780008

1878 11

fluid collection tank

- Maximum capacity: 11 l
- Fluid drain plug
- Interior wall for preventing fluid leakage during transportation



1878 11 11 1 018780011

1878 30

fluid collection tank

- Maximum capacity: 30 l
- Splashproof grate
- Fitted with 4 pivoting wheels

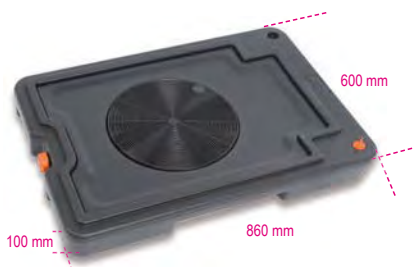

1878 30 30 1 018780030

1879

9.5 l manual/pneumatic operation fluid extractor



1879 1 018790001

1879 6

manual operation fluid extractor, 6 l



1879 6 1 018790000

1879R/K4

kit of 4 spare tubes for fluid extractor 1879



1879R/K4 1 018790504

1879/FUEL

manual operation fluid extractor, 6 l for use with hydrocarbons



1879/FUEL 6 1 018790010

1880

manual barrel pump



1880 gr 240 1 018800001

1880ADB

rotary AdBlue® pump

- 5 litres supplied every twenty turns
- drum extensions up to 1.20 m
- 1 fine-pitch drum coupling, fine pitch
- 1 coarse-pitch drum coupling



1880ADB 1 018800101

1881

pneumatic barrel pump, ratio 3:1



1881 l/min 14 1 018810001

1882

oil gun with flexible end and automatic drip catcher

- 1/2"
- Maximum delivery rate: 65 l/min
- Maximum operating pressure: 100 bar
- Lockable delivery lever



1882 1 018820010

1883

digital litre counter for oil

- 1/2"
- Shockproof rubber coating
- Battery: 1 CR2 (included)
- Max. delivery rate: 0÷35 l/min (0÷9 gal/min)
- Max. pressure: 50 bar (750 psi)
- Viscosity: 8÷5000 mPas
- Tolerance: ±0.5%

CE



1883 1 018830035

1883NC

male-male nipple, 1/2, for items 1882 and 1883



1883NC 1 018830135

1884

oil filler tool
for manual and automatic gearboxes and
differentials

Complete with 12 adaptors for direct connection



1884 1 018840010

AT-101	FORD
AT-102	UNIVERSAL (Bmw, Honda, Nissan...)
AT-103	VW-AUDI
AT-104	VW-AUDI-PORSCHE
AT-105	VW-AUDI-MINI COOPER
AT-106	MERCEDES
AT-107	DSG
AT-108	VW-AUDI CVT
AT-109	VOLVO
AT-110	TOYOTA-LEXUS
AT-111	SKODA
AT-112	VW Passat/Tiguan <2007

1884/C12

case of adaptors for item 1884



1884/C12 1 018840100

1889

steel handling and storage base
for 2 200-l barrels

- Completely hot painted with epoxy powder
- Easy to carry with a fork lift truck or a transpallet
- Support cannot be placed under any part

CE



1889 1 018890200

1889CF

universal barrel opening wrench

- 1 female hexagon Ø 38 mm
- 1 4-sector profile Ø 42 mm
- 1 blade 17x7 mm



L
mm
270 1 018890010

1885

automatic gearbox maintenance station

Allows entire washing cycle to be safely performed in all automatic transmissions, through a simple, guided procedure.
Avoids damage from wear of oil in automatic gearbox, thereby easily and quickly preventing typical malfunctions, including:
excessive gearbox noise, jammed gears, abruptly engaged gears, long gear shifting time.



CE



FUNCTIONAL SPECIFICATIONS

Automatic operation
Step-by-step guided procedure with integrated database
Balancing quantity of injected oil with same quantity of exhausted oil, thereby making sure that system always contains proper quantity of oil
Flow meter for visual inspection of oil quantity
Printing records of each operation

AUTOMATIC SPECIFICATIONS

Injecting solvent (optional)
Washing gearbox system
Emptying oil out of sump
Emptying oil out of converter
Injecting oil into converter

TECHNICAL SPECIFICATIONS

Power supply: 220 V 50 Hz
Backlit oil viewers with 2 white light LEDs
2 electronic balances
Electronic balances, resolution +/- 10 g
Electronic card with backlit graphic display

1885 1 018850010

1885/C1

automatic transmission fittings kit for item 1885

Kit contents:

- 1885/C1-R1 Land Rover Freelander transmission fittings
- 1885/C1-R2 DP0 transmission fitting
- 1885/C1-R3 ZF 9HP transmission fitting
- 1885/C1-R4 ZF 9HP transmission dipstick
- 1885/C1-R5 Mercedes transmission dipstick
- 1885/C1-R6 AISIN TG82 transmission fittings
- 1885/C1-R7 AISIN TG81 transmission fittings
- 1885/C1-R8 Renault-Nissan transmission fittings



1885/C1 1 018850110

1885/C1-R1

Land Rover Freelander transmission fittings
for item 1885

Ic01430



1885/C1-R1 1 018850111

1885/C1-R2

DP0 transmission fitting for item 1885

Ic0990



1885/C1-R2 1 018850112

1885/C1-R3

ZF 9HP transmission fitting for item 1885

Ic0992



1885/C1-R3 1 018850113

1885/C1-R4

ZF 9HP transmission dipstick for item 1885

Ic0192



1885/C1-R4 1 018850114

1885/C1-R5

Mercedes transmission dipstick for item 1885

K-A-M



1885/C1-R5 1 018850115

1885/C1-R6

AISIN TG82 transmission fittings for item 1885

Ic01820



1885/C1-R6 1 018850116

1885/C1-R7

AISIN TG81 transmission fittings for item 1885

Ic0150



1885/C1-R7 1 018850117

1885/C1-R8

Renault-Nissan transmission fittings for item 1885

Ic02150



1885/C1-R8 1 018850118

1885/C2

automatic transmission fittings kit for item 1885

Kit contents:

- 1885/C2-R1 Audi 8HP transmission fittings
- 1885/C2-R2 ZF 9HP transmission fittings without exchanger
- 1885/C2-R3 Audi 0KC transmission fitting
- 1885/C2-R4 AG4-ZF 4HP transmission fittings
- 1885/C2-R5 FIAT transmission fittings
- 1885/C2-R6 Audi Q5-Q7 transmission fittings
- 1885/C2-R7 Audi 0B5 transmission fitting



1885/C2 1 018850120

1885/C2-R1

Audi 8HP transmission fittings for item 1885

Ic0993



1885/C2-R1 1 018850121

1885/C2-R2

ZF 9HP transmission fittings without exchanger for item 1885

Ic0860



1885/C2-R2 1 018850122

1885/C2-R3

Audi 0KC transmission fitting for item 1885

Ic02020



1885/C2-R3 1 018850123

1885/C2-R4

AG4-ZF 4HP transmission fittings for item 1885

Ic0750



1885/C2-R4 1 018850124

1885/C2-R5

FIAT transmission fittings for item 1885

Ic0061



1885/C2-R5 1 018850125

1885/C2-R6

Audi Q5-Q7 transmission fittings for item 1885

Ic0680



1885/C2-R6 1 018850126

1885/C2-R7

Audi 0B5 transmission fitting for item 1885

Ic01720



1885/C2-R7 1 018850127

1885/C3

automatic transmission fittings kit for item 1885

Kit contents:

- 1885/C3-R1 Mercedes DSG transmission fitting
- 1885/C3-R2 POWERSHIFT transmission fitting
- 1885/C3-R3 Toyota IQ transmission fittings
- 1885/C3-R4 Mazda transmission fittings
- 1885/C3-R5 Renault Laguna-Esp transmission fittings
- 1885/C3-R6 Nissan Juke transmission fittings
- 1885/C3-R7 AISIN TF71 FV transmission fittings
- 1885/C3-R8 AISIN TF71 FP transmission fittings
- 1885/C3-R9 AISIN TF71 FO transmission fittings
- 1885/C3-R10 AISIN TF71 FS transmission fittings



1885/C3 1 018850130

1885/C3-R1

Ic0191



1885/C3-R1 1 018850131

1885/C3-R2

POWERSHIFT transmission fitting for item 1885

Ic0190



1885/C3-R2 1 018850132

1885/C3-R3

Toyota IQ transmission fittings for item 1885

Ic0991



1885/C3-R3 1 018850133

1885/C3-R4

Mazda transmission fittings for item 1885

Ic02130



1885/C3-R4

1 018850134

1885/C3-R5

Renault Laguna-Esp transmission fittings for item 1885

Ic02150



1885/C3-R5

1 018850135

1885/C3-R6

Nissan Juke transmission fittings for item 1885

Ic02140



1885/C3-R6

1 018850136

1885/C3-R7

AISIN TF71 FV transmission fittings for item 1885

Ic01420



1885/C3-R7

1 018850137

1885/C3-R8

AISIN TF71 FP transmission fittings for item 1885

Ic001420/1



1885/C3-R8

1 018850138

1885/C3-R9

AISIN TF71 FO transmission fittings for item 1885

Ic001420/2



1885/C3-R9

1 018850139

1885/C3-R10

AISIN TF71 FS transmission fittings for item 1885

Ic001420/3



1885/C3-R10

1 018850140

1893/134A

automatic charging station for R134a gas air conditioners

Fully automatic model, complete with car/lorry database with gas quantities, compressor oil quantities and types, self-diagnosis software for routine maintenance jobs. Database can be updated via software. Machine can be operated in both manual mode (provided it is controlled by a human operator step by step) and in fully automatic mode (without requiring a human operator).



R134A (250 ml)

FUNCTIONAL SPECIFICATIONS

Automatic operation
Car/lorry database with gas quantities and compressor oil quantities and types
Automatic gas recovery from pipe
Compensation of recharged quantity of gas in pipes
Automatic discharge of noncondensable gases
Automatic reporting of defects and required maintenance jobs
Gauges, ø 80 mm
Digital vacuummeter

TECHNICAL SPECIFICATIONS

Gas tank: 15 kg
Vacuum pump: 75 l/min
Electronic balance: 50 kg
Electronic card with backlit display
Recovery rate: 500 rpm
Power supply: 220 V

1893/134A

1 018930001

1893/1234YF

automatic charging station for R1234yf gas air conditioners

Fully automatic model, complete with car/lorry database with gas quantities, compressor oil quantities and types, self-diagnosis software for routine maintenance jobs. Database can be updated via software. Machine can be operated in both manual mode (provided it is controlled by a human operator step by step) and in fully automatic mode (without requiring a human operator).



1234YF (250 ml)

FUNCTIONAL SPECIFICATIONS

Automatic operation
Car/lorry database with gas quantities and compressor oil quantities and types
Automatic gas recovery from pipe
Compensation of recharged quantity of gas in pipes
Automatic discharge of noncondensable gases
Automatic reporting of defects and required maintenance jobs
Gauges, ø 80 mm
Digital vacuummeter

TECHNICAL SPECIFICATIONS

Gas tank: 15 kg
Vacuum pump: 75 l/min
Electronic balance: 50 kg
Electronic card with backlit display
Recovery rate: 500 rpm
Power supply: 220 V

1893/1234YF

1 018930012

1893TR/134A

R134a gas tracer



1893TR/134A 250 ml

1 018930901

1893TR/1234YF

R1234yf gas tracer



1893TR/1234YF 250 ml

1 018930902



1893TR/CI

hybrid compressor tracer



1893TR/CI ^{ml} 250 1 018930903

1895G

control generator for (petrol and LPG) electro-injectors and solenoid valves

Makes it possible to autonomously test efficiency of such parts as:

- EGR solenoid valves
- electro-injectors of petrol and LPG engines
- solenoid valves for variable-geometry turbine adjustment
- compressors for new-generation air conditioners



BENEFITS

- Makes it possible to understand whether part is working mechanically
- Combined with ultrasonic cleaning tanks, it allows more efficient cleaning of parts, electronically controlling part during washing phase
- Essential for air conditioner testing, to check whether compressor and its control valve are efficient

SPECIFICATIONS

Petrol and LPG injector control:

- number of outlets: 4
- test duration: 1-60 s
- Operating time: 5-10 ms
- Impulse frequency range: 1-10 Hz

PWM device control:

- number of outlets: 1
- test duration: 1-60 min
- Automatic or manual
- Duty cycle adjustment: 10%-85%
- Signal frequency regulation: 120-250 Hz

Includes 4 connectors with female FASTON terminals

Power supply: 110-220 V

Dimensions: 334x240x74 mm

Weight: 4 kg

1895G 1 018950800

1895/S

adjustable support for ultrasonic cleaning tanks 1895

Allows injectors to be correctly placed during washing in ultrasonic cleaning tank

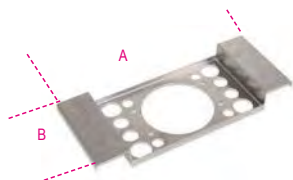

1895/S ^{A mm} 340 ^{B mm} 140 1 018950501

1895 6

ultrasonic cleaning tank, 6 l

with special degas function



CE

- Ultrasonic cleaning relies on fluid heating to effectively clean spare parts and metal pieces in general (injectors, carburetors, valves etc.)
- Digital display for temperature and cleaning time selection
- Two cleaning modes: "soft" and "normal"
- For normal cleaning, just use water at a temperature of 50/60 °C
- For more accurate cleaning, add non-foaming detergent (e.g. Arexons Fulcron Extra) specific for ultrasonic tanks
- Using the degas mode speeds up air release throughout the tank, thereby improving ultrasonic cleaning efficiency

TECHNICAL DATA

Tank capacity: 6 l
Drain tap
Power: 150 W
Heating power: 300 W
Temperature range: 0+80 °C
Cleaning time range: 0-99 minutes
Frequency: 40 kHz
Power supply: 220/230V
Overall dimensions: 330x180x310 mm
Tank dimensions: 300x155x150 mm
Basket dimensions: 250x105x100 mm
Maximum capacity: 5.5 kg

1895 6 ^{Max} 5,5 1 018950060

1895 13

ultrasonic cleaning tank, 13 l

with special degas function



CE

- Ultrasonic cleaning relies on fluid heating to effectively clean spare parts and metal pieces in general (injectors, carburetors, valves etc.)
- Digital display for temperature and cleaning time selection
- Two cleaning modes: "soft" and "normal"
- For normal cleaning, just use water at a temperature of 50/60 °C
- For more accurate cleaning, add non-foaming detergent (e.g. Arexons Fulcron Extra) specific for ultrasonic tanks
- Using the degas mode speeds up air release throughout the tank, thereby improving ultrasonic cleaning efficiency

TECHNICAL DATA

Tank capacity: 13 l
Drain tap
Power: 300 W
Heating power: 400 W
Temperature range: 0+80 °C
Cleaning time range: 0-99 minutes
Frequency: 40 kHz
Power supply: 220/230V
Overall dimensions: 350x325x320 mm
Tank dimensions: 325x235x145 mm
Basket dimensions: 257x185x100 mm
Maximum capacity: 12 kg

1895 13 ^{Max} 12 1 018950130

1895 27

ultrasonic cleaning tank, 27 l

with special degas function



CE

- Ultrasonic cleaning relies on fluid heating to effectively clean spare parts and metal pieces in general (carburetors, valves etc.)
- Digital display for temperature and cleaning time selection
- Two cleaning modes: "soft" and "normal"
- For normal cleaning, just use water at a temperature of 50/60 °C
- For more accurate cleaning, add non-foaming detergent solutions specific for ultrasonic tanks
- Using the degas mode speeds up air release throughout the tank, thereby improving ultrasonic cleaning efficiency

TECHNICAL DATA

Tank capacity: 27 l
Drain tap
Power: 500 W
Heating power: 500 W
Temperature range: 0+80 °C
Cleaning time range: 0-99 minutes
Frequency: 40 kHz
Power supply: 220/230V
Dimensions: 530x330x380 mm

1895 27 ^{Max} 25 1 018950270

1895/RC

rack for ultrasonic tanks 1895



	L	L1	A	
	mm	mm	mm	
1895/RC6	250	105	100	1 018950506
1895/RC13	257	185	100	1 018950513
1895/RC27	450	250	150	1 018950527



1897 professional bench sander

Particularly recommended for surface finishing jobs on several materials (metal, plastic, glass, ceramic, wood etc.). The cabin is made from properly reinforced sheet steel which results in unparalleled sturdiness and firmness.

The cabin is equipped with the following:

- loading door with magnet closure
- perforated sheet metal top
- standard connection for vacuum cleaners, \varnothing 36 mm
- protective polycarbonate viewing window, 6 mm
- LED lamp
- pneumatic circuit (compressed air inlet)
- sanding gun with trigger operation



CE

TECHNICAL DATA

Useful dimensions of cabin: 600x520x320 mm

Overall dimensions: 660x530x500 mm

Weight: 38 kg

Worktop: perforated sheet metal

Lighting: LED

Air consumption: 340 l/min at 7 atm

Power supply: 220 V - 50 Hz

1897 1 018970066

1897/KSA bench sander item 1897, complete with vacuum cleaner item 1871M/AS

CE



1897/KSA 1 018970660

1897/CRB corundum for sander 1897 in 25 kg bag



1897/CRB 1 018970101

1897/G garnet for sander 1897 in 25 kg bag



1897/G 1 018970104

1897/MV glass microspheres for sander 1897 in 25 kg bag



1897/MV 1 018970103

1898/K40 Eco friendly, heated manual cleaning tank

- Using the bio-active liquid included, oil and residue can be effectively removed from mechanical parts without the need for aggressive chemicals
- The bio-active liquid converts the oil and other residue into carbon dioxide and water which can be re-used again and again
- no need for specialist waste collection and disposal
- suitable for both metal and plastic parts

CE



EQUIPMENT:

- long bristle brush and connecting pipe
- right-hand and left-hand operation function
- perforated stainless steel grid
- wheels with brakes
- card with display operating temperature and low level alert

ACCESSORIES INCLUDED:

- 2 20-l cans of environmentally friendly liquid detergent and 2 packs of bacteria
- 2 packs of bio-active liquid

TECHNICAL DATA

- Max. pump capacity: 10 l/min
- Tank capacity: 40 l
- Operating temperature: $+5^{\circ}\text{C}$ \pm $+40^{\circ}\text{C}$
- Dimensions: 900 x 1000 x 750 mm
- Weight: 50 kg (when empty)

1898/K40 1 018980004

ATTENTION

Countries where product 1898/K40 is allowed to be distributed: Austria, Belgium, France (from 2021), Hungary, Italy, Netherlands, Poland, Portugal, Spain, United Kingdom.

1898/B bottle of bacteria, 400 ml, for part cleaning tank 1898/K40



1898/B 1 018980904

1898/D tank of environmentally friendly detergent liquid, 20 l, for part cleaning tank 1898/K40



1898/D 1 018980920

2250-0 heavy duty swivel creeper seat with tray



2250-0 1 022500011

2251-0 heavy duty swivel creeper seat with drawers



2251-0 1 022510011

2252

seat with castors



2252-O	1	022520001
2252-G	1	022520002
2252-R	1	022520003

2252KR4

spare seat castors 2252



2252KR4	1	022520900
---------	---	-----------

2258-0

heavy duty creeper with tool chest



2258-0	1	022580011
--------	---	-----------

2254C

suction cup protector for vehicles' bodies

Made of plastic-coated fabric, with 4 suction cups on top side



	L1	L2	
2254C	1150	650	1 022540200

2254F

car front protector

Allows front part of vehicle to be protected, while leaving openings for headlights and radiator



- Waterproof
- Resistant to oil and grease
- Strap fixing
- Material: 98% polyamide/nylon, 2% polyurethane

2254F	1	022540150
-------	---	-----------

2254K

Reusable seat, steering wheel and gear knob protector

Suits most car seats, steering wheels and gear knobs



2254K	1	022540101
-------	---	-----------

2254SM

creeper mat, made of EVA

Double finish:

- 1 side in soft EVA
- 1 side in hard carbon look for improved slip performance



2254SM	1	022540033
--------	---	-----------

2254T

kneeling pad

made from non-slip EVA foam



2254T	1	022540047
-------	---	-----------

3000M/LT

creeper

• PVC lining with upholstered foamed rubber designed for remarkable comfort



3000M/LT	1	030000220
		7,3 kg

3000M/RLS

spare creeper castors



3000M/RLS	1	030000206
-----------	---	-----------

3002

creeper and seat

- Steel frame
- PVC lining with upholstery
- Easily convertible into a creeper or a seat



3002	1	030020001
------	---	-----------

3002/RLS

6 spare wheels for creeper 3002



3002/RLS	1	030020501
----------	---	-----------

3003

creeper
made of shockproof plastic

- Wheel Ø: 76 mm



3003 1 030030001

3003/RLS

6 spare wheels for creeper 3003



3003/RLS 1 030030501

3003C

creeper made of shockproof plastic

- Complete with:
- head and lumbar region with carbon look finish
 - upper metal plates for fixing magnetic accessories
 - 6 rubber castors, 79 mm in diameter
 - Max. capacity: 120 kg
 - Weight: 5.5 kg



3003C 1 030030100

3003C/RLS

6 spare wheels for creeper 3003C



3003C/RLS 1 030030600

3003PRO

- creeper made of shockproof plastic
Complete with:
- ergonomic head cushion
 - soft back protector
 - 2 178 mm double bearing castors for trouble-free use on uneven surfaces and pipes/cables
 - 1 castor
 - double height adjustment from the ground: 38 or 76 mm
 - 2 portable LED lamps (250 lumens) with fixing magnets
 - load capacity: 200 kg
 - weight: 7.7 kg

NOT AVAILABLE IN THE USA AND CANADA



C max	H min	H Max	H1
kg	mm	mm	mm
200	170	230	230

3003PRO/SP

wall-mounted plastic support for creeper 3003PRO

can be mounted to walls, bridge jacks, chests of drawers or other equipment, thereby allowing creeper to be fixed through a quick system with safety closure.



3003PRO/SP 1 030030151

3003PRO/PM

magnetic tool holder, round, for creeper item 3003PRO

can be applied to wheel rims of creeper to retain small items during jobs



3003PRO/PM 1 030030152

3003PRO/RCR

spare rear wheels for creeper 3003PRO, pair



3003PRO/RCR 1 030030650

3003PRO/RRG

spare front castor for creeper 3003PRO



3003PRO/RRG 1 030030651

3003PRO/RT

LED inspection lamp with spare magnets for creeper 3003PRO

- 250 lumens
- Batteries: 4xAAA (not included)



3003PRO/RT 1 030030652

3006

jack and positioner for tractor and excavator wheels

- max. capacity: 1,500 kg
- min. wheel diameter: 1,000 mm
- max. wheel diameter: 2,200 mm
- max. wheel thickness: 800 mm

CE



3006 1 030060000

3006 R/RGF

spare castor with brake for wheel jack and positioner 3006



3006 R/RGF 1 030060501

3006 R/RG

spare castor for wheel jack and positioner 3006



3006 R/RG 1 030060502

3007

underbody trolley for vehicles
without forecarriage / rear axle

Allows vehicles without
forecarriage or rear axle to be easily handled while working

- 4 pivoting wheels, including 2 with brakes, suitable for use in painting furnaces
- 2 sliding supports to fit all chassis
- max. capacity: 800 kg

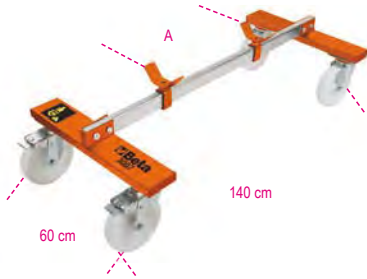

3007
A Max mm 110
1 030070001

3007 R/RGF

spare castor with brake for
vehicle underbody trolley 3007



3007 R/RGF
1 030070501

3007 R/RG

spare castor for
vehicle underbody 3007



3007 R/RG
1 030070502

3008

jack and positioner
for single and twin truck wheels

- max. capacity: 700 kg
- min. height: 140 mm
- max. height: 660 mm
- distance between rollers: 470÷740 mm
- hydraulic overloading safety device
- front pivoting wheels

CE



3008
1 030080100

3009

wheel lifter

Maximum lifting capacity: 550 kg
4 pivoting rollers
Roller width: 200 mm
For wheels up to 240 mm in width



A B
400÷850 mm 600 mm
1 030090001

3009R/GR4

4-wheel groups for trolleys 3009 R/GR4



3009R/GR4
1 030090501

3010/T...

jack stands, pair



C max kg 2000
H min mm 280
H max mm 425
H1 mm 245
L mm 185
L1 mm 165

3010T 2
1 030100002

C max kg 3000
H min mm 285
H max mm 430
H1 mm 250
L mm 180
L1 mm 195

3010T 3
1 030100003

C max kg 6000
H min mm 400
H max mm 580
H1 mm 340
L mm 245
L1 mm 280

3010T 6
1 030100006

C max kg 10000
H min mm 471
H max mm 735
H1 mm 420
L mm 330
L1 mm 290

3010T 10
1 030100010

3011/T

hydraulic bottle jacks

CE



C max kg 3500
H min mm 170
H Max mm 366
L mm 86

3011T 3,5
1 030110035

C max kg 5000
H min mm 203
H Max mm 467
L mm 118

3011T 5
1 030110050

C max kg 10000
H min mm 220
H Max mm 484
L mm 114

3011T 10
1 030110100

C max kg 15000
H min mm 230
H Max mm 497
L mm 113

3011T 15
1 030110150

C max kg 20.000
H min mm 245
H Max mm 521
L mm 115

3011T 20
1 030110200

3010H

heavy-duty jack stands



C Max kg 15,000
H min mm 450
H Max mm 750
L mm 300
L1 mm 300

3010H 750
1 030100150

C Max kg 15,000
H min mm 650
H Max mm 1100
L mm 300
L1 mm 300

3010H 1100
1 030100165

3010V

heavy-duty jack stands,
screw adjustable



C Max kg	H min mm	H Max mm	L mm	L1 mm
20,000	470	680	300	300

3010V 680 1 030100200

C Max kg	H min mm	H Max mm	L mm	L1 mm
20,000	680	1170	300	300

3010V 1170 1 030100220

3012

engine brackets



L mm	C max kg		
1500	500	1	030120010
1800	400	1	030120018

3012C

lower engine bracket

ideal for cars and commercial vehicles



3012C 1 030120255

3012I

lower engine bracket

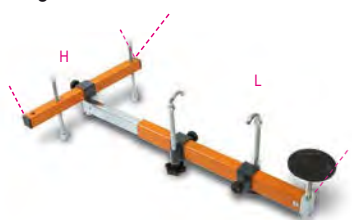

L mm	H mm		
630=960	190	1	030120250

3014

engine stand



3014 1 030140010

3014R/GR5

5 spare wheels for engine stand 3014



3014R/GR5 1 030140501

3014 SAR

folding engine stand

- Easy to fold up, for significantly increased compactness
 - Allows 360° rotation of engine or gear
 - Provides unparalleled safety and stability during jobs
- Maximum capacity: 450 kg



3014SAR 1 030140360

3014SAR/RR

4 spare wheels for engine stand 3014SAR



3014SAR/RR 1 030140370

3014SAR/1

fluid collection tank
for item 3014 SAR

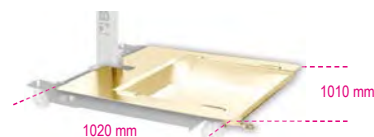

3014SAR/1 1 030140361

1020x1010x11 mm

3014SAR/2

clamp for fixing transmission gear on stand
item 3014 SAR

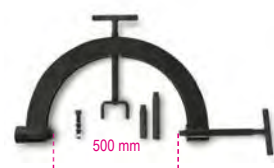

3014SAR/2 1 030140362

3025

folding hydraulic crane with dual effect pump

Maximum capacity: 1 t

CE



3025 3025 1 030250001

3025/RF

2 spare fixed wheels for hydraulic crane 3025



3025/RF 1 030250901

3025/RG

2 spare swivel wheels for hydraulic crane 3025



3025/RG 1 030250902

3025/PF

barrel handling pliers

Maximum capacity: 300 kg

CE



3025/PF	A mm	B mm	1	030250011
	550+640	70		

3026 0,3

hydraulic pit and under bridge jack

CE



3026 0,3	1	030260003

3026/R0,3

4 spare swivel wheels for hydraulic jack 3026 0,3



3026/R 0,3	1	030260903

3026 0,5

hydraulic pit and under bridge jack

Maximum capacity: 500 kg

CE



3026 0,5	1	030260005

3026/R0,5

4 spare swivel wheels for hydraulic jack 3026 0,5



3026/R 0,5	1	030260905

3026 1,0

hydraulic pit and under bridge jack

Maximum capacity: 1 t

CE



3026 1,0	1	030260010

3026/R 1,0

4 spare swivel wheels for hydraulic jack item 3026 1,0



3026/R 1,0	1	030260910

3026/S

swivel transmission gear support with reduction bushes for jacks item 3026

Maximum capacity: 500 kg



3026/S	1	030260501

3026/SP

Universal transmission support

Allows one operator to disassemble and reassemble any transmissions of cars, commercial vehicles and off-rovers quickly and safely.



3026/SP	1	030260505

3026/SA

wheel hub support for pit jacks

- for use for maintenance jobs relating to hubs, and during shock absorber replacement jobs
- can be adapted to hydraulic pit jacks items 3026 0,3 and 3026 0,5



3026/SA	Ø mm	1	030260510
	30,4		

3026/SAM

shock absorber support for pit jacks

- for use for supporting shock absorber when suspension arm is removed
- shock absorber bracket, max. diameter 80 mm, plus adapter for max. diameters 60 mm
- can be adapted to hydraulic pit jacks items 3026 0,3 and 3026 0,5



3026/SAM	1	030260515

3027 10

hydraulic bench press with moving piston

Maximum capacity: 10 t

CE



3027 10 1 030270010
90 kg

3027 20

hydraulic press with moving piston
20 t

Maximum capacity: 20 t

CE



3027 20 1 030270020
140 kg

3027 30

hydraulic press with moving piston and hoist

Maximum capacity: 30 t

CE



3027 30 1 030270030
230 kg

3027 50

hydraulic press with moving piston and hoist

Maximum capacity: 50 t

CE



3027 50 1 030270050
350 kg

3027/KP

set of pin punches and plate
for press item 3027



3027/KP10	3027 10	1	030270510
3027/KP20	3027 20	1	030270520
3027/KP30	3027 30	1	030270530
3027/KP50	3027 50	1	030270550

3027/KPP50

pedal control for hydraulic press item 3027
20-30-50



3027/KPP50 1 030270555

3027/PR

press supporting tool for removal/insertion of
hubs, bearings and silent blocks

Universal system which allows user to mount/dismount hubs, bearings and silent blocks into/from their housings by operating under a press, through a supporting base and its accessories. Tool can adapt to irregular geometric shapes of hubs/king pins on which operator must work.



TECHNICAL DATA

Working range: min. 130 mm - max. 186 mm
Dimensions: 300 x 300 mm
Weight: 13 kg
Max. load-bearing capacity: 20 t

3027/PR 1 030270400

3029/2T

lowered hydraulic jack, 2 t, with 4 wheels

- Quick approach pedal
- Steel frame and nylon wheels
- Minimum height: 75 mm

CE



3029/2T 1 030290020

3029L/2T

long, lowered jack, 2 t

Makes it possible to work on vehicles with reduced height
from the ground and internal lifting point

- Controlled descent speed
- Quick approach pedal
- Nylon wheels

CE



3029L/2T 1 030290120

3029/2T-L/RP

spare 85-mm rubber plate for items 3029/2T and 3029L/2T



3029/2T-L/RP 1 030290502

3029/2T-L/R6

spare rear wheel for items 3029/2T and 3029L/2T



3029/2T-L/R6 1 030290506

3029/2T-L/R5

spare front wheel for jacks item 3029/2T and item 3029L/2T



3029/2T-L/R5 1 030290505

3030/2T

lowered car jack, 2 t with 6 wheels

- dual front tilting wheels made of plastic material (PTFE)
- car jack can be easily handled on uneven, irregular floors
- maximum capacity: 2 tons



3030/2T 1 030300020

43 kg

3030/2T-R5

front wheel with pin for jack 3030 2T



3030 2T/R5 1 030300505

3030/2T-R6

spare rear wheel for item 3030/2T



3030 2T/R6 1 030300506

3030/2TRP

spare 85-mm rubber plate for item 3030/2T



3030/2TRP 5 030300501

3033/3T

hydraulic jack, 3t long version

- For use on commercial vehicles
- Maximum capacity: 3 t
- Polyamide wheels

CE



3033/3T 1 030330030



3035

tyre trolley

- 2 castors Ø 260 mm
- 2 castors Ø 125 mm
- Maximum carrying capacity: 200 kg
- Forks can be adjusted in 2 positions: first position: maximum opening 880 mm second position: maximum opening 980 mm
- Can be used as a top by locking position horizontally



3035 1 030350100

3036

wheel handling base

Non-marking rubber castors



3036 1 030360063



3061/2T

air hydraulic jack, 2 tons - 2 stages

CE



B	415 mm
C	250 mm
D	132-326 mm
E	2 t

Fitted with:

- high-resistance three-layer diaphragm and internal telescopic guide
- end-of-stroke stop and overloading safety valve
- can also be used on auto lifts

TECHNICAL DATA

capacity: 2 t
weight: 14 kg
power supply pressure: 8-10 bar
height: min. 132 - max. 326 mm

3061/2T

1 030610020

3061/2T-P50

50-mm extension for item 3061/2T



3061/2T P50

1 030610021

3061/2T-P100

100-mm extension for item 3061/2T



3061/2T P100

1 030610022

3065/20-10T

air hydraulic jack, 20-10 t, with case

Portable and lightweight, ideal for road assistance operations

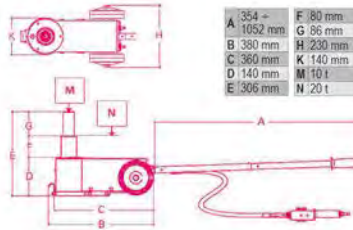

354 -	F 80 mm
A 1052 mm	G 86 mm
B 380 mm	H 230 mm
C 360 mm	K 140 mm
D 140 mm	M 10 t
E 306 mm	N 20 t

- Supplied with two extensions, 75 and 60 mm long

TECHNICAL DATA

capacity: 20-10 t
weight: 23 kg
power supply pressure: 8-10 bar
air consumption: 400 l/min

3065/20-10T

1 030650100

3065/40-20T

air hydraulic jack, 40/20 tons

CE

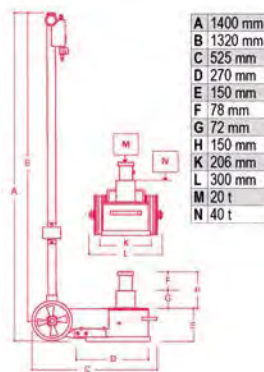

A	1400 mm
B	1320 mm
C	525 mm
D	270 mm
E	150 mm
F	78 mm
G	72 mm
H	150 mm
K	206 mm
L	300 mm
M	20 t
N	40 t



- suitable for use on heavy vehicles
- functional and easy to handle, for transportation on mobile repair shops as well
- automatic piston return
- two descent valves with under load speed control

TECHNICAL DATA

capacity: 40/20 tons
weight: 39 kg
power supply pressure: 8-10 bar
air consumption: 400 l/min

3065/40 20T

1 030650200

3067/60-15T

air hydraulic jack, 60-30-15 t

With a minimum height of no more than 120 mm, it is particularly suitable for use on buses, coaches and public means of transport

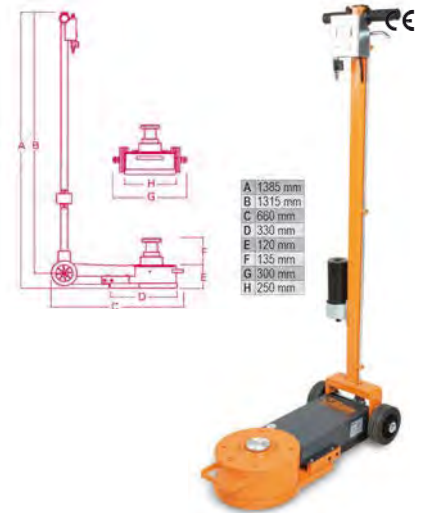

A	1385 mm
B	1315 mm
C	660 mm
D	330 mm
E	120 mm
F	135 mm
G	300 mm
H	250 mm

- Automatic piston return
- Two descent valves with under load speed control
- supplied with two extensions, 70 and 120 mm long

TECHNICAL DATA

capacity: 60-30-15 t
weight: 56 kg
power supply pressure: 8-10 bar
air consumption: 600 l/min

3067/60-30-15T

1 030670120

3067/70-13T

air hydraulic jack, 70-43-23-13 t

CE

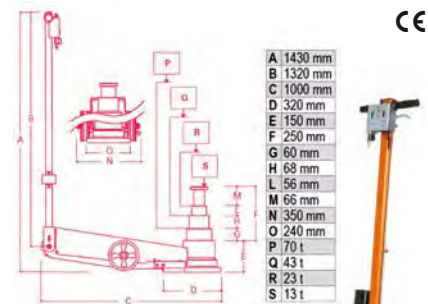

A	1430 mm
B	1320 mm
C	1000 mm
D	320 mm
E	150 mm
F	250 mm
G	60 mm
H	68 mm
L	56 mm
M	66 mm
N	350 mm
O	240 mm
P	70 t
Q	43 t
R	23 t
S	13 t

- Long version, suitable for use on lorries, articulated vehicles, buses and coaches, and agricultural machines
- automatic piston return
- two descent valves with under load speed control

TECHNICAL DATA

capacity: 70-43-23-13 tons
weight: 74 kg
power supply pressure: 8-10 bar
air consumption: 600 l/min

3067/70 13T

1 030670130





MOTORCYCLE TOOLS

Beta's products are synonymous with unparalleled quality and reliability, as the result of eighty years of experience and tradition.

Our products are regularly updated, their quality being highly appreciated by the engineers and mechanics of the best racing teams in the Road Racing World Championship Grand Prix, Superbike World Championship, Motocross World Championship and World Enduro Championship.



3040C

rear motorcycle stand, adjustable

- Matt black lacquer
- 4 thermoplastic rubber wheels
- Includes V-shaped sliders, pair
- Includes L-shaped sliders, pair



3040C 1 030400002

3040C/S1

V-shaped sliders, pair, for item 3040C



3040C/S1 1 030400503

3040C/S2

rubber L-shaped sliders, pair, for item 3040C



3040C/S2 1 030400504

3041C

front motorcycle stand, adjustable

- Matt black lacquer
- 4 thermoplastic rubber wheels
- Includes roller sliders, pair
- Includes cone-shaped sliders, pair



3041C 1 030410002

3041C/12

roller sliders, pair, for item 3041C



3041C/12 1 030410512

3041C/16

cone-shaped sliders, for item 3041C



3041C/16 1 030410516

3042C

front stand for motorcycle steering pin

- Matt black lacquer
- 4 thermoplastic rubber wheels
- Includes 8-pin kit Ø 13 - 15 - 15.5 - 17 - 19 - 20 - 21 - 27



3042C 1 030420002

3043C

motorcycle stand with left single arm

- Matt black lacquer
- 4 thermoplastic rubber wheels
- Optional pin



3043C 1 030430002

3043C/ 41÷47

pin for item 3043C



	∅ mm	
3043C/41 Ducati	21,5 ÷ 25,5	1 030430551
3043C/42 KTM - Triumph	27,5	1 030430552
3043C/43 MV	42,5	1 030430553
3043C/44 Ducati	40,5	1 030430554
3043C/45 Honda	28,5	1 030430555
3043C/47 BMW	53,5	1 030430557

3047C

pedal stand for cross/enduro motorcycles



3047C 1 030470002

3048C

Steel racing cross stand



3048C 1 030480002

3050/CC

chock cradle centre stand for Custom, Enduro, Cross, Scooter motorcycles
includes adjustable support kit

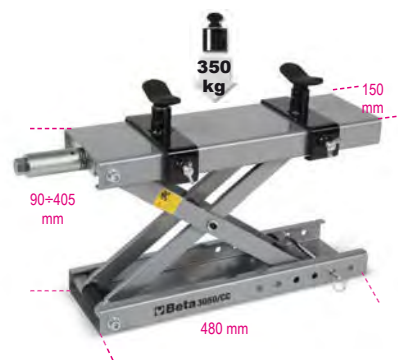

3050/CC 1 030500012



3050/600

electro-hydraulic motorcycle jack,
600 kg



CE



- 3050/O
- 3050/G
- 3050/R

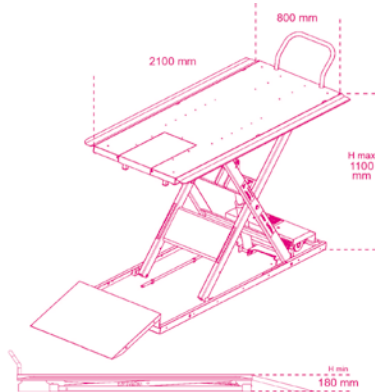

Technical specifications

- Electrical, mechanical and hydraulic safety devices
- Capacity: 600 kg
- Integrated electro-hydraulic unit: 230V - 50 Hz
- Hydraulic pump
- Controlled downward speed
- Safety fuses for protection in case of cable cuts
- control push button panel
- CE-certified, TÜV-approved

	L	L	H min	H Max	
	mm	mm	mm	mm	
3050/O	975	2100	185	1110	1 030500201
3050/G	975	2100	185	1110	1 030500202
3050/R	975	2100	185	1110	1 030500203

3050/KA

widening kit for jack item 3050/600

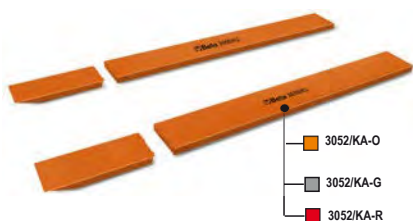

- 3052/KA-O
- 3052/KA-G
- 3052/KA-R

	A	B	
	mm	mm	
3050/KA-O	107,5	2100	1 030500221
3050/KA-G	107,5	2100	1 030500222
3050/KA-R	107,5	2100	1 030500223

3050/MS

wheel clamp for jack item 3050/600



allows motorcycle front wheel to be locked to bridge



3050/MS 1 030500032

3050/MV

mechanical screw wheel clamp
for jack 3050/600



3050/MV 1 030500034

3050/LA

non-slip sheet metal top
for jack item 3050/600

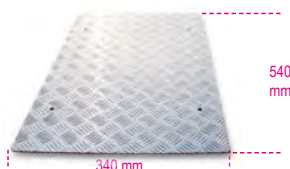

3050/LA 1 030500062

9562T3

garage mat
Dimensions: 300x160 cm



- particularly suitable for use under motorcycle jacks

- protects floor from oil and petrol leaks, environmentally friendly
- easy to clean, anti-skid, rubber-coated bottom



9562T3 1 095620300

3054

moving base for central stand or motorcycle
rear wheel
with extension for side stand



3054 1 030540000

3055M

automatic van clamp



Allows motorcycle front wheel
to be fixed



3055M 1 030550002

3057

aluminium ramp for loading/unloading
motorcycles

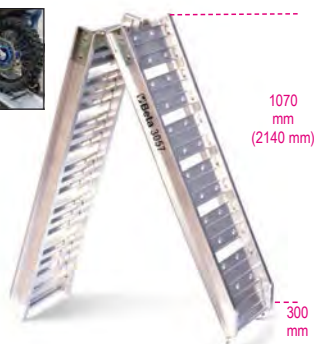

3057 1 030570001

3070B

manual static balancer



- Allows wheel balancing both in the workshop and on racing tracks
- Equipped with rolling bearings, rabbet level and adjustable feet for unparalleled precision
- Comes with 2 hub cones

3070B 1 030700100

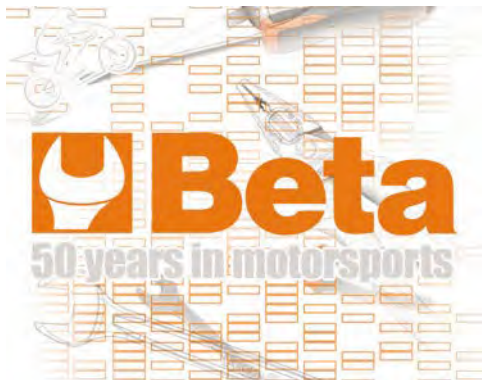

3070BE/K

electronic hand-spin wheel balancer, portable

balancing system with hand-spin microprocessor (without motor), for balancing iron or alloy car and motorcycle wheels



CE



- compact and easy to carry, for use in garages, trucks or track pits
- can be mounted to a workbench or a wall
- software includes all unbalance correction programmes, reading of positions with adhesive weights (ALUS), weights hidden behind spokes (SPLIT) and unbalance optimization
- can be used with swivel support BETA 3070BE/S (optional)

ACCESSORIES SUPPLIED WITH WHEEL BALANCER

- flexible graduated ruler
- ring nut with handwheel and 3 cones $\varnothing 45 + 110$ mm

TECHNICAL DATA

Power supply: 115-230V AC o 12-24V DC
 Max. absorbed power: 0.15 kW
 Balancing speed: 100 rpm
 Measurement uncertainty: 1 g
 Rim width: 1.5" + 20" (40 + 510 mm)
 Max. wheel diameter: max. 75 kg

3070BE/K

1 030700250

3070BE/S

swivel support for portable electronic wheel balancer item 3070BE

allows wheel balancer to be fixed to a wall or a workbench, thereby resulting in reduced installation space



	L	L1
	mm	mm
3070BE/S	514	280

1 030700201

3070BE/F

universal motorcycle flange, $\varnothing 40$ mm, for item 3070BE

for use on wheels with central through-holes, $\varnothing 15 \pm 35$ mm, and on flanged wheels with truing up to $\varnothing 68$ mm



3070BE/F

1 030700202

3070BE/B

kit of 8 motorcycle wheel truing sockets for item 3070BE

Designed to work on following diameters:
 28 - 25 - 22 - 20 - 19.05 - 17 - 16 - 15



3070BE/B

1 030700203

3073

universal fork oil seal driver fitting tool

for fork tube diameters 35 ± 48 mm



3073

1 030730001

3075A

hexagon socket for wheel hub nuts

12"



	Ø	Ø	L
	mm	mm	mm
3075A 28	28	38	30
3075A 30	30	40	30

1 030750028
 1 030750030

3075B

bi-hex socket for wheel hub nuts

12"

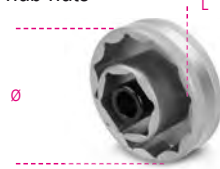

	Ø	Ø	L
	mm	mm	mm
3075B 55	55	70,7	25

1 030750155

3075MV

bi-hex socket for MV AGUSTA wheel hub nuts

12"

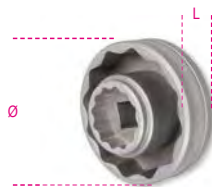

	Ø	Ø	L
	mm	mm	mm
3075MV 56	56	70,7	30

1 030750156

3075/CM

multiple hexagon socket for wheel pins



3075/CM
 12-14-17-19-22-24 mm

1 030750212

3075/K10

set with a universal wrench with interchangeable head and 10 bits, for tightening wheel spokes

Sizes: 5.2 - 5.4 - 5.6 - 5.8 - 6.0 - 6.2 - 6.4 - 6.6 - 6.8 - 7.0



3075/K10

1 030750410

3079/21

cable oiler

Allows proper lubrication of clutch cables and gas control, for increased sheath smoothness and cable duration.



3079/21

1 030790021

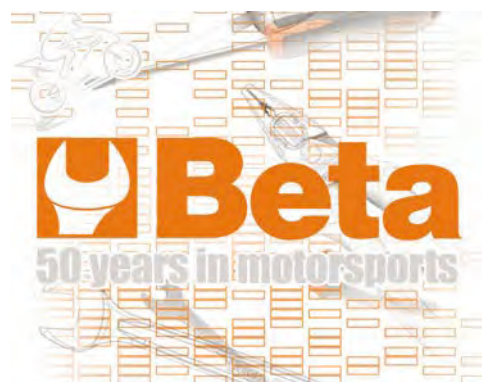

3080/C15

chain opening and riveting kit



Ø 3-4-5 mm and Regina kit



3080/C15 1 030800015

420x185x60 mm

3080R/CS3

kit with 3 spare pin punches for chain tool 3080/C15



Ø 3-4-5 mm



3080R/CS3 1 030800503

3081

portable chain tool



Sturdy and foldable, easily fitting into enduro tool bags. Suitable for chain sizes 415, 420, 428, 520, 525, 530, 532



3081 1 030810010

3085

tool for retracting brake pistons



Suitable for motorcycle and scooter brake callipers



3085 1 030850010

3091

flywheel pullers with internal thread



	M		
3091/10	24x1,5	1	030910010
3091/20	26x1,0	1	030910020
3091/30	28x1,0	1	030910030
3091/40	30x1,0	1	030910040
3091/45	30x1,5	1	030910045
3091/50	32x1,5	1	030910050
3091/60	33x1,5	1	030910060
3091/70	35x1,0	1	030910070
3091/75	35x1,5	1	030910075
3091/80	38x1,5	1	030910080

3092

flywheel pullers with external thread



	M		
3092/10	18x1,5	1	030920010
3092/20	19x1,0	1	030920020
3092/30	27x1,25/20x1	1	030920030
3092/35	22-26x1,5	1	030920035
3092/40	25x1,5/22x1	1	030920040
3092/50	26-28x1,0	1	030920050
3092/60	28x1,5	1	030920060

3093/E

tool for locking flywheel, clutch bell and pulleys



3093/E 1 030930100

3093/U

multiple flywheel puller



3093/U	M10x1.25R	1	030930050
	M14x1.5R		
	M16x1.5R		
	M18x1.5R		
	M24x1.0R		
	M27x1.0L		

Beta



BICYCLE TOOLS

We partner UAE Team Emirates, which is led by the General Manager, Giuseppe Saronni, and competes at UCI World Tour level



Partnership 2020



3912T

TOP workshop workbench for bicycle maintenance

- With support for central movement
- Tool drawer



3912T 1 039120010

3912P

PRO workshop workbench for bicycle maintenance

- With support for central movement
- Tool drawer



3912P 1 039120110

3912T/AD12

adapters with 12-mm through hole, pair



- For workbenches 3912T and 3912P



Ø	L	Ø1
mm	mm	mm
12	50	23,5

3912T/AD12 1 039120012

3912T/AD15

adapters with 15-mm through holes, pair



- For workbenches 3912T and 3912P



Ø	L	Ø1
mm	mm	mm
15	50	23,5

3912T/AD15 1 039120015

3912T/AD20

adapters with 20-mm through holes, pair



- For workbenches 3912T and 3912P



Ø	L	Ø1
mm	mm	mm
20	50	23,5

3912T/AD20 1 039120020

3912T/ADC

cone-shaped adapters, pair



- For workbenches 3912T and 3912P
- For DownHill, MTB, Cross Country bicycles



Ø	L
mm	mm
27	22

3912T/ADC 1 039120035

3916MM

workshop single-sided clamp for bicycle maintenance



- Clamp can be rotated 360°
- Carrying capacity: 20 kg



3916MM 1 039160110

3921

derailleur hanger alignment gauge

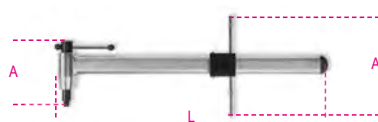

L	A	A1
mm	mm	mm
440	115	165

3921 1 039210010

3923

blade guide tool for cutting airfoil shaped seatposts up to 80 mm and tubes 1" ÷ 1.1/2"

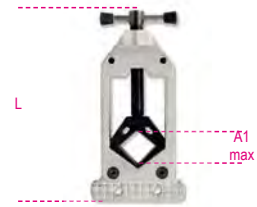

L	A1 max	Ø max
mm	mm	mm
160	80	45

3923 1 039230010

3927

handlebar clamp



3927 1 039270010

3932U

professional chain tool compatible with chains from 5 to 11 speeds



L	L1
mm	mm
164	115

3932U 1 039320011

3935

chain wear indicator



3935 1 039350010

3937

missing link pliers



3937 1 039370010

3948

crank extractor

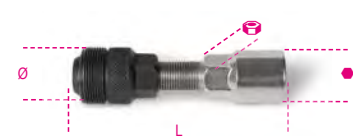

Ø	L	Ø	●
mm	mm	mm	mm
14	79	20	15

3948 1 039480015

3952
simple cone wrench



mm	L mm		
13	205	2	039520013
14	205	2	039520014
15	205	2	039520015
16	205	2	039520016
17	205	2	039520017
18	205	2	039520018
19	205	2	039520019
20	205	1	039520020
21	205	1	039520021
22	205	1	039520022
24	205	1	039520024



3952/S7 13-14-15-16 17-18-19 mm	1	039520207
3952/S11 13-14-15-16 17-18-19-20-21-22-24 mm	1	039520211

3953
pedal wrench



mm	L mm		
15	401	1	039530015

3955
open end wrenches for universal headsets



mm	L mm		
30x32	292	1	039550108
32x36	319	1	039550114

3961 3,2
spoke wrench, black, 3.2 mm



mm			
3,2		1	039610032

3961 3,3
spoke wrench, green, 3.3 mm



mm			
3,3		1	039610033

3961 3,5
spoke wrench, red, 3.5 mm



mm			
3,5		1	039610035

3961U
professional spoke wrench, 3.2 - 4.0 mm



mm			
3,2 - 4,0		1	039610100

3962SH
double spoke wrench for Shimano



L mm	A1 mm	A2 mm		
132	4,3	4,4	1	039620010

3962MV
double spoke wrench for Mavic



L mm	A1 mm	A2 mm		
135	4,3	8,4	1	039620020

3963P
special wrench for flat spokes



L mm			
129		1	039630010

3964
special nipple driver



L mm	L1 mm		
170	89	1	039640010

3965
wheel alignment gauge, $\varnothing 20'' \div 29''$



L mm			
680		1	039650010

3965C
professional wheel truing stand



- For $\varnothing 20'' \div 29''$
- Through axle hub adapter, 10 \div 20mm

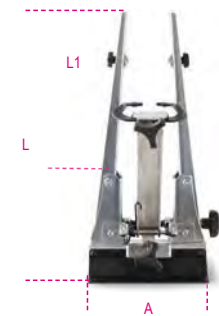

L mm	L1 mm	A mm		
500	380	285	1	039650110

3967
sprocket removal wrench with chain whip



- Caters for up to 11 speed cassettes
- 2PVC handle
- Also suitable for fixed wheels



L mm			
289		1	039670010

3969
tyre lever



L mm	A mm		
200	15,6	1	039690010

3969K3
kit with 3 tyre levers, made of plastic



L mm			
113		1	039690130

3971

wrench for Shimano plastic bolts



- Suitable for Shimano Hollowtech II cranksets



N°	mm		
8	8		1 039710010

3972

bottom bracket removal wrench



- Suitable for Shimano® Hollowtech II, Campagnolo® Ultra-torque, FSA®, SRAM®



L			
mm			1 039720010
252			

3973PF

Press-Fit bearing removal tool



- Suitable for inside Ø 24 mm and 30 mm



L			
mm			1 039730001
240			

3973/1

16-notch bottom bracket removal socket



- Suitable for Shimano® XTR BB93, Dura-Ace® BB9000

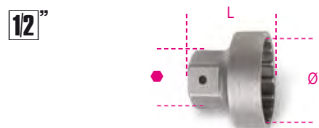

Ø	mm	mm	L		
mm	39	24	mm	34	
					1 039730010

3973/2

16-notch bottom bracket removal socket



- Suitable for Shimano® BBR60 (Ultegra® 11 speeds)



Ø	mm	mm	L		
mm	41	24	mm	35	
					1 039730020

3973/3

16-notch bottom bracket removal socket



- Suitable for Shimano® Hollowtech II, Campagnolo® Ultra-torque, FSA®, SRAM®

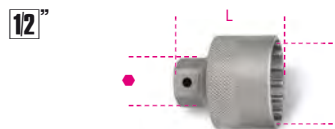

Ø int.	mm	mm	L		
mm	46	24	mm	53,5	
					1 039730030

3973/4

20-notch bottom bracket removal socket with central pin, nickel-plated



- Suitable for Shimano and ISIS



Ø	L	mm			
mm	mm	mm			1 039730040
31,5	55	24			

3975

bearing cup press



- For headset cup assembly, compatible with headset cups 1", 1.1/8", 1.1/4", 1.1/2" and 2"



L	Ø				
mm	mm			1 039750010	
360	16x1				

3984/1

BMX freewheel removal wrench, 2 grafts

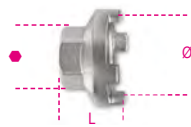

Ø	L	mm			
mm	mm	mm			1 039840010
35	25,5	24			

3984/2

Shimano freewheel removal wrench



Ø	L	mm			
mm	mm	mm			1 039840020
22,8	26	24			

3984/3

Shimano freewheel removal wrench, cassette with guide pin

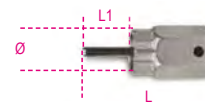
**12"**

Ø	L	L1			
mm	mm	mm			1 039840030
23,5	65	25			

3984/4

Campagnolo freewheel removal wrench, with guide pin



Ø	L	L1	mm		
mm	mm	mm	mm		1 039840040
23	51	13	24		

3984/5

freewheel removal wrench, 2 grafts

**12"**

Ø	L	mm			
mm	mm	mm			1 039840050
18,5	38	21			

3984/6

freewheel removal wrench, 4 grafts

**12"**

Ø	L	mm			
mm	mm	mm			1 039840060
19,5	36	21			

3991

lever for pushing back disc brake pads



L	A	α			
mm	mm	°			1 039910010
222	36	7°			

3992

disc brake straightener



L	A1				
mm	mm			1 039920010	
234	4 55	2,2			



INSULATED TOOLS

Beta Utensili's insulated tools are meant to guarantee installation and electrical maintenance men's safety. All of the insulated tools make it possible to work on systems up to 1000V on alternating current and up to 1500V on direct current.

To provide the highest quality and performance standards and verify fitness and compliance with EN 60900, each tool is subjected to the following stringent tests: handle resistance to slipping and flame propagation, and high voltage test (10000V). For assortments and thermoformed trays, see relevant sections.

All of Beta's insulated tools are built in accordance with the specifications of EN60900 and are approved by the best European certification institutions



Istituto Italiano del Marchio di Qualità - I



Verband der Elektrotechnik
Elektronik Informationstechnik - D

1000 V

SAFETY TESTS: tested at 10,000 V to work on 1,000 V electrical installations.

Beta's high-insulation tools are tested piece by piece at 10 kV, with a view to providing unparalleled quality for working instruments which are required to ensure ultra-high safety standards: they make it possible to work at voltages up to 1,000 V a.c. (1,500 V d.c.).

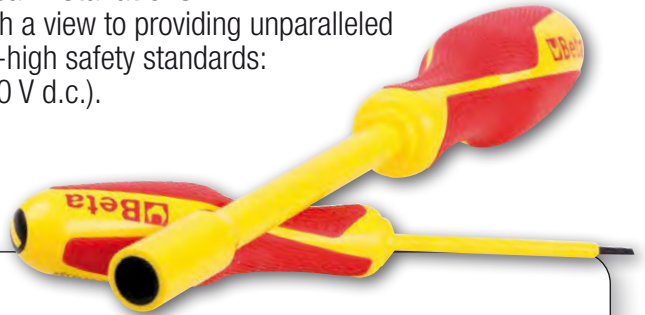

SAFETY STANDARDS:

Although extremely stringent tests are performed during production, before using a tool, the operator must always check the insulating handle for tears, modifications or damage. Keeping the dielectric properties unchanged in time is closely connected with the mechanical, chemical or thermal stress the tool may be subjected to. In case the insulator should get damaged, the tool cannot be considered safe for use in live installations. Always wear protective goggles and insulated gloves.

TESTS PERFORMED DURING PRODUCTION



100% visual test:

All the surface finishes of the tools must be free from externally visible defects

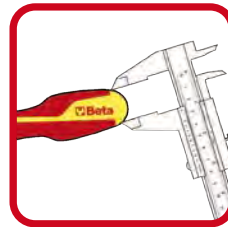

Dimensional test:

All the dimensions of the tools must comply with the design specifications.



Crash test:

After 2 hours at -25°C , the tool is hit three times (by such a specific weight as provided for by the standard); the insulating handle must not show any signs of damage.



Electrical insulation test:

Following immersion in water for 24 hours, the tool is subjected to a voltage of 10 kV for 3 minutes. Current dissipation must not exceed such values as provided for by the standard.



Penetration test:

A weight of 2 kg is applied to the tool handle at $+70^{\circ}\text{C}$ for two hours. Later a voltage of 5 kV is applied to the area that is subjected to mechanical pressure for 3 minutes. No signs of current passing through must be shown.

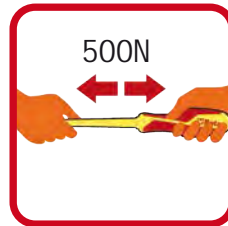

Adhesion test:

after 168 hours at $+70^{\circ}\text{C}$, the tool is subjected to a load of 500 N to check that the handle does not slip off.

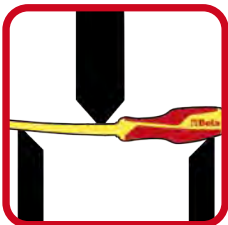

Mechanical test:

The tools must satisfy such mechanical performance requirements as provided for in the relevant ISO standards



Marking indelibility test:

Following the friction test with isopropyl alcohol, markings must remain legible.



Flame propagation test:

A flame is directed towards the tool for 10 seconds; during the next 20 seconds, the flame must not exceed a height of 120 mm.



52MQ

single open end wrenches



EN 60900

mm	L mm		
6	90	1	000520106
7	96	1	000520107
8	100	1	000520108
9	108	1	000520109
10	110	1	000520110
11	120	1	000520111
12	132	1	000520112
13	140	1	000520113
14	146	1	000520114
15	166	1	000520115
16	156	1	000520116
17	168	1	000520117
18	170	1	000520118
19	176	1	000520119
21	190	1	000520121
22	200	1	000520122
24	225	1	000520124
27	210	1	000520127
30	240	1	000520130
32	240	1	000520132

89MQ

single ring wrenches



EN 60900

mm	L mm		
6	150	1	000890106
7	155	1	000890107
8	155	1	000890108
9	160	1	000890109
10	170	1	000890110
11	180	1	000890111
12	190	1	000890112
13	195	1	000890113
14	200	1	000890114
15	210	1	000890115
16	216	1	000890116
17	218	1	000890117
18	236	1	000890118
19	240	1	000890119
21	250	1	000890121
22	255	1	000890122
24	280	1	000890124
27	300	1	000890127
30	320	1	000890130
32	340	1	000890132

110MQ

adjustable wrench with scale



EN 60900

L mm	A max		
200	28	1	001100520
250	30	1	001100525
300	30	1	001100530

606MQ/50

click-type torque wrench with reversible ratchet



EN 60900
UNI EN 26789
ISO 6789

Nm	Kgfm	lb.ft	A mm	L mm	g
5÷50	0,5÷5	4÷40	90	375	1130

606MQ/50 1 006060705

850MQ

magnetic bit holder, insulated, with bimaterial handle



IMQ CSV
EN 60900

L mm	L1 mm	D mm		
233	125	12.5	1	008500910

910MQ/B

bi-hex sockets



EN 60900

mm	L mm	Ø1 mm	Ø mm		
6	45	14	24	1	009100616
7	45	15	24	1	009100617
8	45	16	24	1	009100618
9	45	17	24	1	009100619
10	45	19	24	1	009100620
11	45	20	24	1	009100621
12	45	24	24	1	009100622
13	45	24	24	1	009100623
14	45	25	24	1	009100624
15	45	27	24	1	009100625
16	45	27.5	24	1	009100626
17	45	30	24	1	009100627
18	45	31	24	1	009100628
19	45	32	24	1	009100629

910MQ/PE

socket drivers for hexagon screws



EN 60900

mm	Ø mm	L mm		
4	24	100	1	009100604
5	24,5	100	1	009100605
6	25,0	100	1	009100606
8	25,0	100	1	009100608
10	25,5	100	1	009100610

910MQ/TX

socket drivers for Torx(R) head screws



EN 60900

mm	Ø mm	L mm	L1 mm		
15	23	116	61	1	009100641
20	24,5	116	65	1	009100642
25	24,5	116	65	1	009100643
27	24,5	116	65	1	009100644
30	24,5	116	65	1	009100645
40	24,5	116	65	1	009100646

910MQ/XZN

socket drivers with XZN® profile



EN 60900

mm	Ø mm	L mm	L1 mm		
M8	24	106	57	1	009100658
M10	24	106	57	1	009100660

910MQ/PT

preset extensions with 3/8" female drive



EN 60900

Nm	L mm	L1 mm		
12	80	35,5	1	009100801

910MQ/21

3/8" drive extension



EN 60900

L mm	Ø mm		
140	13,4	1	009100804

910MQ/22

3/8" drive extension



EN 60900

L mm	Ø mm		
265	13,4	1	009100805

910MQ/T

3/8" drive, T-handle



910MQ/55

3/8" drive reversible ratchet

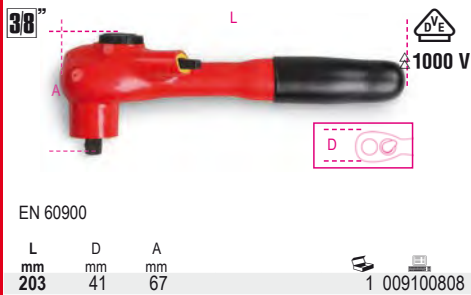

910MQ/C16

8 bi-hex sockets,
4 hexagon socket drivers
and 4 accessories



910MQ/C16

1 009100917

- 910MQ/B 8 - 10 - 11 - 12 - 13 - 14 - 17 - 19 mm
- 910MQ/PE 4 - 5 - 6 - 8 mm
- 910MQ/21 125 mm
- 910MQ/22 250 mm
- 910MQ/T
- 910MQ/55

914MQ/A

hexagon hand sockets,
3/8" female drive,
made from special polyamide-based
technopolymers
Specially designed for batteries of hybrid and electric cars

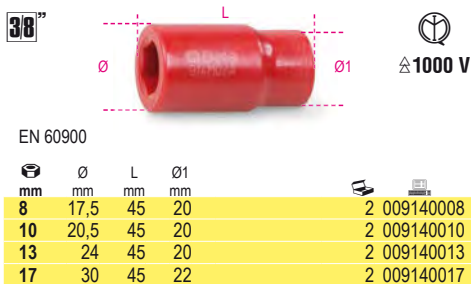

914MQ-A/S4

8-10-13-17 mm

1 009140054

920MQ/A

hexagon sockets



Ø	L	Ø1
mm	mm	mm
8	21,5	57
9	21,5	57
10	21,5	57
11	21,5	57
12	23,0	57
13	23,0	57
14	23,0	57
16	23,0	57
17	30,0	57
18	32,0	57
19	32,2	57
20	32,0	57
21	34,0	57
22	36,0	57
24	39,0	57
27	42,0	57
30	44,0	57
32	48,0	57

1 009200238
1 009200239
1 009200240
1 009200241
1 009200242
1 009200243
1 009200244
1 009200246
1 009200247
1 009200248
1 009200249
1 009200250
1 009200251
1 009200252
1 009200254
1 009200257
1 009200260
1 009200262

920MQ/PE

socket drivers for hexagon screws



Ø	L	L1
mm	mm	mm
*4	28,5	94,50
*5	28,5	94,5
*6	28,5	94,5
*8	28,5	94,5
10	28,5	94,5
12	28,5	94,5

1 009200264
1 009200265
1 009200266
1 009200268
1 009200267
1 009200269

920MQ/21

1/2" square drive extension bar



920MQ/22

1/2" square drive extension bar



920MQ/T

1/2" square drive, T-handle

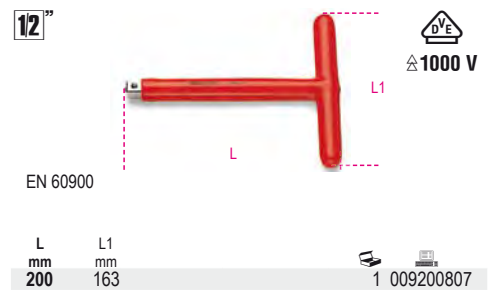

920MQ/55A

1/2" square drive reversible ratchet
with socket locking system

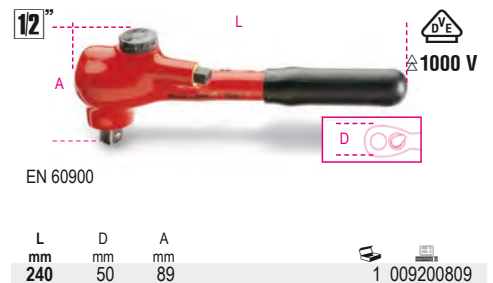

920MQ/C16

9 hexagon sockets,
3 socket drivers for hexagon screws
and 4 accessories



920MQ/C16

1 009200917

- 920MQ/A 8 - 10 - 12 - 13 - 14 - 17 - 19 - 22 - 24 mm
 - 920MQ/PE 5 - 6 - 8 mm
 - 920MQ/21 135 mm
 - 920MQ/22 264 mm
 - 920MQ/55A
 - 920MQ/T
- 420x280x60 mm - 5,2 kg

943MQ

hexagon nut spinners with handles



EN 60900

mm	L mm	L1 mm	D mm		
5,5	233	125	12,2	1	009430235
6	233	125	12,5	1	009430236
7	240	125	14,3	1	009430237
8	240	125	15,3	1	009430238
10	252	125	17,3	1	009430240
13	252	125	21,3	1	009430243

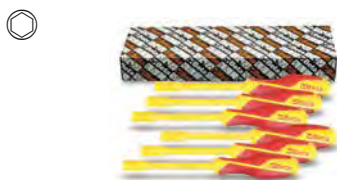

943MQ/S6	1	009430250
5,5-6-7-8-10-13 mm		

951MQ

T-handle wrenches with hexagon male ends



EN 60900

mm	L mm	L1 mm		
3	120	105	1	009510703
4	165	105	1	009510704
5	170	105	1	009510705
6	168	105	1	009510706
8	165	105	1	009510708
10	200	105	1	009510710

993MQ

bent knurled point spring tweezers



EN 60900

L mm		
147	1	009930040

994MQ

straight knurled point spring tweezers



EN 60900

L mm		
145	1	009940040

1010MQ

long round nose pliers



EN 60900

L mm	L1 mm		
160	51,5	1	010100096

1048MQ

slip joint pliers, boxed joint

• Chrome-plated finish



EN60900

L mm	A max mm	L1 mm		
250	48	39	1	010480315

1082MQ

diagonal cutting nippers



EN 60900

L mm	L1 mm	mm		
140	20	1,6	1	010820094
160	22	1,6	1	010820096

1084MQ

heavy duty diagonal cutting nippers



EN 60900

L mm	L1 mm	mm		
200	26	2,0	1	010840100

1088MQ

end cutting nippers



EN 60900

L mm	L1 mm	mm		
160	7	1,6	1	010880096

2115P L-MQ32



2115PL-MQ32

320

1128MQ

electrician's scissors, stainless steel blades, with microteeth



IEC60900

L mm	L1 mm		
145	45	1	011280101

1132MQ

cable cutter with insulated handles for copper and aluminium cables



EN 60900

L mm	mm		
230	18	1	011320193

1142MQ

wire stripping pliers



EN 60900

L mm	mm ²		
160	0,5÷6	1	011420096

1150MQ

combination pliers, bright chrome-plated



EN 60900

L mm	L1 mm	mm		
160	37	1,6	1	011500096
180	39	1,8	1	011500098
200	43	2,0	1	011500100
220	46	2,0	1	011500102

1162MQ

extra long flat nose pliers



EN 60900

L mm	L1 mm	mm		
160	56	1,6	1	011620096
200	76	1,6	1	011620100

1164MQ

extra-long bent flat nose pliers



EN 60900

L mm	L1 mm	mm		
160	54	1,6	1	011640096
200	76	1,6	1	011640100

1166MQ

extra long needle nose pliers



EN 60900

L mm	L1 mm	mm		
160	56	1,6	1	011660096
200	76	1,6	1	011660100

1168MQ

extra long bent needle nose pliers



EN 60900

L mm	L1 mm	mm		
160	50	1,6	1	011680096
200	70	1,6	1	011680100

1272MQ/F

screwdrivers for cross head Phillips® screws



EN60900

PHxDxL mm	L1 mm			
1x4.5x80	187	3	012720409	
2x6x100	218	3	012720418	

1272MQ

screwdrivers for cross head Phillips® screws

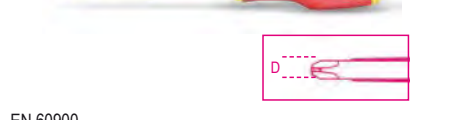

EN 60900

PHxDxL mm	L1 mm			
0x3x60	160	3	012720703	
1x4.5x80	187	3	012720709	
2x6x100	218	3	012720718	
3x8x150	276	2	012720724	
4x10x200	326	2	012720727	



1272MQ/S5
PH0x3x60-PH1x4,5x80
PH2x6x100-PH3x8x150
PH4x10x200 mm

1 012720751

1273MQ/F-D6

set of 6 slim screwdrivers

1274MQ/F: 0.5x3.5x100 - 0.8x4.5x100 - 1x5.5x125 - 1.2x6.5x150 mm



1272MQ/F: PH1x4.5x80- PH2x6x100 mm

1 012730406

1273MQ/F-D6

1274MQ/F 0.5x3,5x100 - 0.8x4,5x100 - 1x5,5x125 - 1.2x6,5x150 mm

1272MQ/F PH1x4.5x80- PH2x6x100 mm

1273MQ/D6

set of 6 screwdrivers



1273MQ/D6

1274MQ 0,5x3x100 -0,8x4x100
1,0x5,5x125 mm

1272MQ PH0x3x60 -PH1x4,5x80
PH2x6x100 mm

1 012730851

1274MQ/F

screwdrivers for headless slotted screws

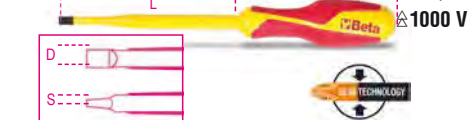

EN60900

SxDxLmm	L1 mm			
0.6x3.5x100	200	3	012740403	
1x4.5x100	205	3	012740406	
1x5.5x125	232	3	012740409	
1.2x6.5x150	268	3	012740412	

1274MQ

screwdrivers for headless slotted screws



EN 60900

SxDxL mm	L1 mm			
0,4x2,5x75	175	3	012740700	
0,5x3x100	200	3	012740703	
0,8x4x100	207	3	012740706	
1x5,5x125	232	3	012740709	
1,2x6,5x150	268	3	012740712	
1,2x8x175	301	2	012740715	
1,6x10x200	326	2	012740718	



1274MQ/S6
0,5x3x100-0,8x4x100
1x5,5x125-1,2x6,5x150
1,2x8x175-1,6x10x200 mm

1 012740751

1275MQ/C

screwdrivers for combined cross head PH + slotted head screws

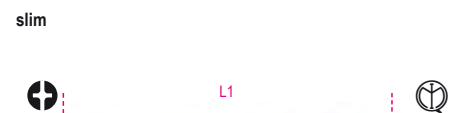

EN60900

PH1+LPP	2	012750409		
PH2+LPP	2	012750418		

1276MQ/C

screwdrivers for combined cross head PZ + slotted head screws

slim

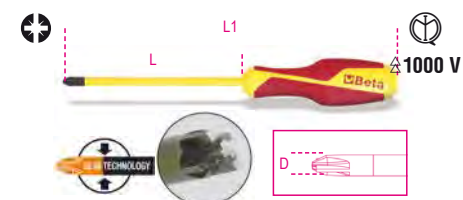

EN 60900

☉ PZ1+LPP	2	012760409
☉ PZ2+LPP	2	012760418

1279MQ/F

screwdrivers for cross head Pozidriv®-Supadriv® screws

slim

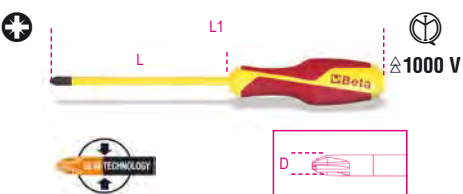

EN60900

pz	L mm	L1 mm		
1	80	187	3	012790409
2	100	218	3	012790418

1279MQ

screwdrivers for cross head Pozidriv®-Supadriv® screws



EN 60900

PZ	L mm	L1 mm		
0	60	160	3	012790703
1	80	187	3	012790709
2	100	218	3	012790718
3	150	276	2	012790724



1279MQ/S4	1	012790751
-----------	---	-----------

1725MQ

mini-hacksaw frame



EN 60900

	L mm	H mm		
1725MQ	260	85	1	017250030

1777MQ/C

cable stripping knife, insulated

• for multicore cables



EN 60900

1777MQ/C	L mm		
	190	1	017770026

1777MQ/U

cable stripping knife, insulated



EN 60900

1777MQ/U	L mm		
	190	1	017770011

1777RL/U

4 spare blades for utility knife 1777MQ/U



1777RL/U	1	017770021
----------	---	-----------

1995MQ/T

insulating mat

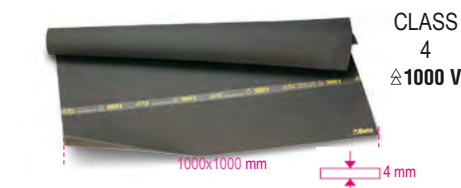

VDE 0303
EN 60243

1995MQ/T	LxSxH mm		
	1000x1000	1	019950030

1995MQ/G1 - G2

insulating gloves in latex



EN 60903

	Gr.	L mm		
1995MQ/G1	9	410	1	019950010
1995MQ/G2	10	410	1	019950013

1996MQ/T

insulating cloth

500x500mm

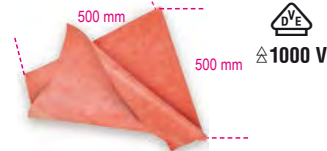

DIN EN 61112

1996MQ/T	S mm		
	0.5	1	019960005

1996MQ/GM

composite insulating gloves

EN60903
EN388



EN 60903
EN 61482

	Gr.	L mm		
1996MQ/GM 9	9	410	1	019960109
1996MQ/GM 10	10	410	1	019960110

1996SVG

pneumatic tester for insulated gloves

mandatory testing in accordance with EN90603



1996SVG	1	019960133
---------	---	-----------





TETHERED TOOLS

Beta H-SAFE

The H-SAFE tool range by Beta comprises over 200 coded items, for which a holding system has been individually designed to withstand extremely severe mechanical stress, as synonymous with unparalleled safety.

Operating comfort is also crucial: tools with a double active part, including combination wrench item 42, are tied with a cable which runs along the entire body of the tool; whereas twisting tools, including screwdrivers, are tied with freely rotating rings preventing the string from getting twisted.



The H-SAFE holding system has been designed, tested and manufactured in Beta's factories. With the H-SAFE system by Beta, tools are always within reach, comfortably and safely.

35HS

flat chisels, ribbed type

with H-SAFE tethered system



L mm	A mm		
200	23,0	1	000354004
250	28,5	1	000354005

42NEWHS

combination wrenches, open and offset ring ends

with H-SAFE tethered system



DIN 3113 UNI-ISO 7738

mm	L mm		
6x6	95	1	000424506
7x7	105	1	000424507
8x8	116	1	000424508
9x9	127	1	000424509
10x10	137	1	000424510
11x11	148	1	000424511
12x12	158	1	000424512
13x13	169	1	000424513
14x14	180	1	000424514
15x15	190	1	000424515
16x16	201	1	000424516
17x17	212	1	000424517
18x18	222	1	000424518
19x19	233	1	000424519
20x20	243	1	000424520
21x21	254	1	000424521
22x22	264	1	000424522
23x23	275	1	000424523
24x24	285	1	000424524
25x25	296	1	000424525
26x26	307	1	000424526
27x27	317	1	000424527
28x28	328	1	000424528
29x29	338	1	000424529
30x30	349	1	000424530
32x32	370	1	000424532
34x34	391	1	000424534
36x36	412	1	000424536

42HS/AS

combination wrenches, open and offset ring ends

with H-SAFE tethered system



mm	L mm		
1/4x1/4	95	1	000424106
5/16x5/16	116	1	000424108
3/8x3/8	137	1	000424110
7/16x7/16	148	1	000424111
1/2x1/2	169	1	000424113
9/16x9/16	180	1	000424114
5/8x5/8	201	1	000424116
11/16x11/16	212	1	000424117
3/4x3/4	233	1	000424119
13/16x13/16	254	1	000424121
7/8x7/8	264	1	000424122

mm	L mm		
15/16x15/16	285	1	000424124
1x1	296	1	000424125
1.1/16x1.1/16	317	1	000424127
1.1/8x1.1/8	338	1	000424129
1.1/4x1.1/4	370	1	000424132
1.5/16x1.5/16	391	1	000424133

55HS

double open end wrenches

with H-SAFE tethered system



UNI-ISO 10102 DIN 3110

mm	L mm		
6x7	120	1	000554012
8x9	140	1	000554021
10x11	155	1	000554030
12x13	170	1	000554042
14x15	185	1	000554054
16x17	202	1	000554060
18x19	220	1	000554066
20x22	236	1	000554075
21x23	245	1	000554078
22x24	245	1	000554081
24x27	262	1	000554090
30x32	297	1	000554108
34x36	325	1	000554117

91HS-C

heavy duty offset ring wrenches

with H-SAFE tethered system



mm	Ø mm		
36	54	1	000914036
41	62	1	000914041
46	69	1	000914046

91HS

heavy duty offset ring wrenches

with H-SAFE tethered system



mm	Ø mm		
36	54	1	000914236
41	62	1	000914241
46	69	1	000914246

92HS

tubes for item 91

with H-SAFE tethered system



L mm	91 mm	Ø mm		
610	32+41	22	1	000924020
760	46+55	25	1	000924030

93HS

double-ended offset ring wrench for scaffolding bolts

with H-SAFE tethered system



mm	L mm		
21x22	310	1	000934021

96THS

offset hexagon key wrenches, with high torque handles

with H-SAFE tethered system



mm	L mm	L1 mm		
2,5	153	55	1	000964935
3	153	55	1	000964936
4	179	70	1	000964938
5	200	84	1	000964940
6	221	103	1	000964941
8	255	117	1	000964943
10	285	132	1	000964945

96THS-AS

offset hexagon key wrenches, with high torque handles

with H-SAFE tethered system



mm	L mm	L1 mm	Ø mm		
5/32	200	84	6	1	000964673
3/16	200	84	6	1	000964674
7/32	221	103	7	1	000964675
1/4	236	106	8	1	000964676
5/16	255	117	10	1	000964678
3/8	285	132	12	1	000964680

97TTXHS

offset key wrenches with handles for Torx(R) head screws
with H-SAFE tethered system

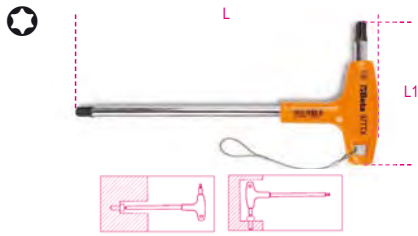

Ø	L	L1		
mm	mm	mm		
T10	179	70	1	000974710
T15	179	70	1	000974715
T20	179	70	1	000974720
T25	179	70	1	000974725
T30	200	84	1	000974730
T40	221	103	1	000974740
T45	236	106	1	000974745
T50	255	117	1	000974750

111HS

adjustable wrenches with scales, chrome-plated
with H-SAFE tethered system

- Right-hand rotation of pin
- With mm and inch scale



DIN 3117 ISO 6787

L	L	A max	A1		
mm	mm	mm	mm		
200	8	28	62,0	1	001114020
250	10	34	70,0	1	001114025
300	12	35	84,0	1	001114030
380	15	45	97,0	1	001114038
450	18	54	115,0	1	001114045

142HS

reversible ratcheting combination wrenches
with H-SAFE tethered system



Ø	L		
mm	mm		
8x8	136	1	001424008
9x9	143	1	001424009
10x10	159	1	001424010
11x11	168	1	001424011
12x12	174	1	001424012
13x13	180	1	001424013
14x14	190	1	001424014
15x15	200	1	001424015
16x16	216	1	001424016
17x17	233	1	001424017
18x18	239	1	001424018
19x19	248	1	001424019
21x21	285	1	001424021
22x22	285	1	001424022
24x24	325	1	001424024
27x27	355	1	001424027
30x30	420	1	001424030
* 32x32	420	1	001424032

* Straight model without inverter

360HS

pipe wrenches, Stillson pattern
with H-SAFE tethered system



L	Ø		
mm	max "		
250	1" gas	1	003604025
350	1 1/2" gas	1	003604035
450	2" gas	1	003604045
600	2 1/2" gas	1	003604060

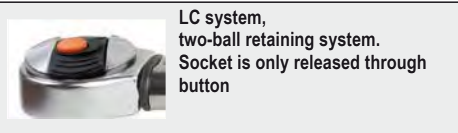

LC system,
two-ball retaining system.
Socket is only released through
button

666HS

Click-type torque wrenches
with reversible ratchets
for right-hand tightening
torque accuracy: ±3%

with H-SAFE tethered system



ISO 6789

Nm	Kgfm	lbf.ft	■	D	A	L	g
10÷50	1÷5	7÷37	3/8	mm	mm	mm	660

666HS/5 1 006664005

Nm	Kgfm	lbf.ft	■	D	A	L	g
20÷100	2÷10	15÷75	3/8	mm	mm	mm	730

666HS/10 1 006664010

Nm	Kgfm	lbf.ft	■	D	A	L	LC	g
40÷200	4÷20	30÷150	1/2	mm	mm	mm	system *	1010

666HS/20LC 1 006664021

Nm	Kgfm	lbf.ft	■	D	A	L	LC	g
60÷300	6÷30	50÷220	1/2	mm	mm	mm	system *	1380

666HS/30LC 1 006664031

900E-HS/55

reversible ratchets
with H-SAFE tethered system



DIN 3122 - UNI-ISO 3315

L	Ø	A	■		
mm	mm	mm	1/4		
125	25	18	1/4	1	009004880

910E-HS/55

reversible ratchets
with H-SAFE tethered system

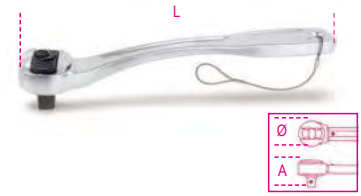

DIN 3122 - UNI-ISO 3315

L	Ø	A	■		
mm	mm	mm	3/8		
200	30	33	3/8	1	009104880

920E-HS/55LC

reversible ratchets "Locking System"

with H-SAFE tethered system

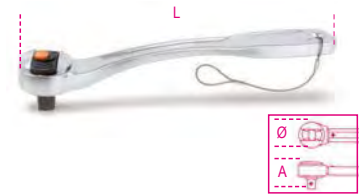

DIN 3122 - UNI-ISO 3315

L	Ø	A	■		
mm	mm	mm	1/2		
275	40	43	1/2	1	009204860

932HS

double ended hexagon / bi-hex offset socket
wrenches, bright chrome-plated
with H-SAFE tethered system

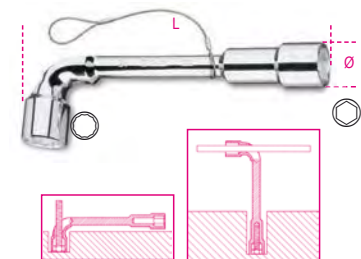

NF E 74.303

Ø	Ø	L		
mm	mm	mm		
6x6	11,5	110	1	009324006
7x7	12,5	116	1	009324007
8x8	13,0	120	1	009324008
9x9	14,0	125	1	009324009
10x10	16,5	133	1	009324010
11x11	17,5	143	1	009324011
12x12	19,0	148	1	009324012
13x13	19,5	154	1	009324013
14x14	21,5	167	1	009324014
15x15	22,5	182	1	009324015
16x16	24,5	193	1	009324016
17x17	26,0	198	1	009324017
18x18	26,5	215	1	009324018
19x19	29,0	220	1	009324019

1032HS

internal circlip pliers, straight pattern PVC-coated handles with H-SAFE tethered system



UNI 7914 DIN 5256

L	∅	∅1	A		
mm	mm	mm	mm		
140x1,3	12÷25	1,3	20	1	010324014
180	19÷60	1,9	21	1	010324017

1034HS

internal circlip pliers, bent pattern, 90° PVC-coated handles with H-SAFE tethered system



UNI 7914 DIN 5256

L	∅	∅1	A		
mm	mm	mm	mm		
170	19÷60	1,9	21	1	010344017

1036HS

external circlip pliers, straight pattern PVC-coated handles with H-SAFE tethered system



UNI 7915 DIN 5254

L	∅	∅1	A		
mm	mm	mm	mm		
140x1,3	10÷25	1,3	20	1	010364014
175	19÷60	1,9	21	1	010364017

1038HS

external circlip pliers, bent pattern, 90° PVC-coated handles with H-SAFE tethered system



UNI 7915 DIN 5254

L	∅	∅1	A		
mm	mm	mm	mm		
175	19÷60	-	21	1	010384017

1048BM-HS

slip joint pliers, boxed joint, bimaterial handles with H-SAFE tethered system

· new 9-position model



ISO 8976

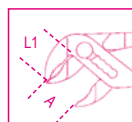

L	A max	L1	g		
mm	mm	mm	g		
250	48	39	460	1	010484215

1052HS

adjustable self-locking pliers, concave jaws with H-SAFE tethered system

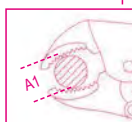

L	A	A1 max	S		
mm	mm	mm	mm		
240	72	42	10,0	1	010524024

1082BM-HS

diagonal cutting nippers, bi-material handles with H-SAFE tethered system



UNI/ISO 5749

L	L1	∅	A		
mm	mm	mm	mm		
160	22	1,6	28,0	1	010824036

1088BM-HS

heavy duty end cutting nippers, bi-material handles with H-SAFE tethered system



UNI/ISO 5748

L	L1	∅	A		
mm	mm	mm	mm		
160	9	1,6	28,0	1	010884036
200	11	2,0	36,0	1	010884040

1128BAX-HS

Double-acting electricians' scissors, with milling profiles in DLC-coated stainless steel with H-SAFE tethered system

Double-acting cutting: a special cam on the fulcrum allows the blades to run lengthwise, which results in increased cutting power while closing the blades.

Profile and mill: designed to enlarge holes on plastic, from 13 mm to 25 mm.

DLC coating: DLC (diamond-like carbon) is an innovative carbon-based coating: the high hardness and low coefficient of friction arise from the simultaneous presence of carbon on the surface in the form of graphite, and diamond.

- High blade surface hardness (resistance to abrasion and wear)
- Low coefficient of friction (smoothness and anti-adherence)
- Anti-loose eccentric pin
- Large handles with pipe throttling grooves
- With articulated plastic case
- Patented



L	L1	∅			
mm	mm	mm	mm ²		
150	50	50		1	011284088

1132BM-HS

cable cutters for insulated copper and aluminium cables, bi-material handles with H-SAFE tethered system



UNI 8791

L	∅	A	B		
mm	mm	mm	mm		
230	18	37	12,5	1	011324143

1150BM-HS

combination pliers bright chrome-plated, bi-material handles with H-SAFE tethered system



ISO 5746

L mm	L1 mm	mm	A mm		
160	42	1,6	22,0	1	011504146
180	46	1,8	25,0	1	011504148
200	50	2,0	27,0	1	011504150

1166BM-HS

extra long needle knurled nose pliers, bi-material handles with H-SAFE tethered system



ISO 5745

L mm	L1 mm	mm	A mm		
200	76	1,6	22,0	1	011664040

1168BM-HS

extra long bent needle knurled nose pliers, bi-material handles



ISO 5745

L mm	L1 mm	mm	A mm		
200	70	1,6	22,0	1	011684040

1290HS

screwdrivers for slotted head screws H-SAFE



ISO 2380

SxAxL mm	L1 mm	Ø mm		
0,4x2,5x75	171	2,5	1	012904006
0,5x3x100	196	3,0	1	012904012
0,6x3,5x100	196	3,5	1	012904021
0,8x4x100	196	4,0	1	012904030
0,8x4x150	246	4,0	1	012904036
1x5,5x150	259	5,0	1	012904042
1,2x6,5x150	270	6,0	1	012904051
1,2x8x150	282	7,0	1	012904057
1,6x10x200	332	8,0	1	012904066

1292HS

screwdrivers for cross head Phillips® screws with H-SAFE tethered system



UNI/ISO 8764

PHxDxL mm	L1 mm		
0x3x100	196	1	012924006
1x4,5x120	229	1	012924012
2x6x150	270	1	012924021
3x8x150	282	1	012924024

1294HS

screwdrivers for headless slotted screws

with H-SAFE tethered system



SxDxL mm	L1 mm		
0,5x2,5x60	156	1	012944003
0,6x3x75	171	1	012944006
0,8x4x100	196	1	012944012
1x5x125	234	1	012944018

1299HS

screwdrivers for cross head Pozidriv(R)-Supadriv(R) screws with H-SAFE tethered system



UNI/ISO 8764

PZ	L mm	L1 mm		
0	60	156	1	012994000
1	80	189	1	012994003
2	100	220	1	012994006
3	150	282	1	012994009

1370T-HS

mechanic's hammers fibre shaft with H-SAFE tethered system



g	A mm	L mm	L1 mm		
300	23	300	105	1	013704630
500	27	320	118	1	013704650
1000	36	360	135	1	013704700

1370FT-HS

riveting hammers, fibre shafts

with H-SAFE tethered system



A mm	L mm	L1 mm	B mm		
28	280	86	22	1	013704528
30	280	92	24	1	013704530
36	300	104	29	1	013704536

1390HS

soft face hammers, wooden shafts with H-SAFE tethered system



UNI 7784

D mm	L mm	L1 mm		
35	310	95	1	013904035
45	320	107	1	013904045



1392HS

dead-blow hammers, with interchangeable plastic faces, steel shafts with H-SAFE tethered system



D	L	L1		
mm	mm	mm		
35	305	115	1	013924035
40	310	125	1	013924040
50	325	135	1	013924050
60	385	155	1	013924060

1602A-HS

crimping pliers for insulated terminals, standard model with H-SAFE tethered system



mm ²	L	A	B		
mm ²	mm	mm	mm		
0÷6	220	42	4	1	016024005

1682HS

flexible graduated rules made from stainless steel with H-SAFE tethered system

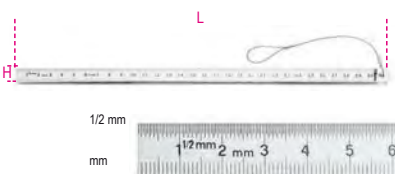

L	H	±		
mm	mm	mm		
200	13	0,5	1	016824020
300	13	0,5	1	016824030

1692HS

measuring tapes, shock-resistant bi-material ABS casings, steel tapes, precision class II

with H-SAFE tethered system



L	S		
m	mm		
3	16	1	016924053
5	19	1	016924055

1708HS/20

metric feeler gauges with H-SAFE tethered system



S	S	L		
mm	mm	mm		
0,05±1,0	0,002±0,040	105	1	017084020

1727HS

hacksaw frame, heavy series with H-SAFE tethered system



L	L1		
mm	mm		
515	300	1	017274001

1743HS

fitting tool for nylon ties with H-SAFE tethered system

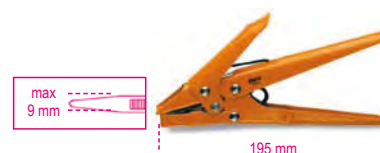

L	A	B		
mm	mm	mm		
195	85	17	1	017434001

1750HS

lever operated grease guns with H-SAFE tethered system



1 g, 550 bar Max

cc	L		
mm	mm		
500	380	1	017504500

1760BHS

digital multimeter with H-SAFE tethered system



SPECIFICATIONS

DC voltage: 200 mV-2/20/200/1000V
 AC voltage: 2-20/200/700V
 DC current: 2/20/200 mA-20 A
 AC current: 2/200 mA- 20 A
 Resistance: 200Ω - 2/20/200 kΩ - 2/20 MΩ
 Capacity: 2/20/200 nF - 2/200 μF
 Temperature: -20° + 1000°C/ -4 °F ~ +2000°F
 Frequency: 20kHz
 Power supply: 1 9V battery (included)

1760BHS

1 017604012

Beta

Beta

1772H-HS

safety utility knife with retractable blade, supplied with 2 blades with H-SAFE tethered system



L mm	A mm	
170	18	1 017724029

1778SOS-HS

car service knife with window breaking hammer and seat belt cutter features in case with H-SAFE tethered system



L mm	A mm	L1 mm	
205	25	85	1 017784080

8871

safety belt with metal double closure buckle. To connect H-SAFE tools



L cm	min-max	
70	70-100	1 088710070
100	100-135	1 088710100

8872A

fixed loop

• For belt item 8871



8872A 50	
	1 088720050

8872AS

strap loop

• For belt item 8871



8872AS 25	
	1 088720525

8873

tool bag with self-locking

• For belt item 8871



8873	
	1 088730230

8877

cushioned hook-up lace

• MAX 2.7 kg



8877 80	L cm min+max	DxL mm	
	70-110	40x80	1 088770080

8877M

cushioned hook-up lace

• With anti-winding joint
• MAX 2.7 kg



8877M 20-140	L cm min+max	DxL mm	
	20-140	30x60	1 088770510

8879

strap wristband

• MAX 2.7 kg



8879	D mm	
	30	1 088790025

8880

hard hook-up lace

• With anti-winding joint



8880	L Cm	D mm	
	30	10	1 088800030

8883

tool bag

• Made of anti-abrasion nylon 840
• MAX 20 kg
• Snap link for stopping zip at top
• 6 tool retaining strings
• Interior pocket



8883	DxH cm	
	30x40	1 088830030





STAINLESS STEEL TOOLS



Stainless steel is an alloy steel with a high chromium content.

Chromium forms a surface oxide film which protects metal and immediately reforms in case of chemical or mechanical damage.

We at **Beta Utensili** have relied on this unique characteristic to develop the **Beta Inox** tools, which are the name for high resistance to corrosion as well as remarkable **hygiene** and **low bacterial retentiveness**. Indeed, stainless steel tools **get less dirty and are cleaned better** than those made from other materials, and can be **autoclaved at 121 °C**.

The **Beta Inox** tools can be used in **critical environments** – that is, in areas where absolutely no contamination is permitted.

Fields of application:

- Nuclear applications
- Pharmaceutical production - class C
- Biotechnological and biomedical laboratories
- Food industry.

The **Beta Inox** tools avoid ferrous contamination, thus preventing improper **rust formation**. Whenever any tools made of ordinary carbon steel are used on stainless steel screws, nuts or surfaces, a few iron particles may come off the tools, which results in aesthetic problems (**iron moulds**). If neglected, these trigger localized corrosion. Using stainless steel tools will completely prevent polluting particles from spreading.



STAINLESS STEEL + NO STAINLESS STEEL = RUST



STAINLESS STEEL + STAINLESS STEEL = NO RUST

Fields of application:

- Shipyards
- Building
- Offshore applications
- Solar systems
- Car industry

Mechanical characteristics

Beta's tools are made of magnetic **steel AISI 420**. Its outstanding mechanical characteristics translate into tools whose performance far exceeds the standards and is comparable to that of Beta's other tools.

These tools share the same ergonomic properties and design as Beta's other tools, which have been known to, and appreciated by, professional users for over 80 years.

The containers are made of **steel AISI 304**, which can boast remarkable cold formability properties and even higher corrosion resistance.

Recyclability

Stainless steel is **100% recyclable**. This is also a major plus.



Mark for stainless steel products
Released by Centro Inox – Italian Stainless Steel Development Association
– for products made of stainless steel.

34INOX

flat chisels,
made of stainless steel



L mm	A mm	Ø mm		
160	18	18	1	000340318
200	20	20	1	000340320

39INOX

wedges,
made of stainless steel



L mm	A mm	S mm		
100	50	10	1	000390310
150	50	13	1	000390315
200	40	40	1	000390320

42INOX

combination wrenches
made of stainless steel



DIN 3113 - UNI ISO 7738

mm	L mm		
6x6	95	2	000420306
7x7	105	2	000420307
8x8	116	2	000420308
9x9	127	2	000420309
10x10	137	2	000420310
11x11	148	2	000420311
12x12	158	2	000420312
13x13	169	2	000420313
14x14	180	2	000420314
15x15	190	2	000420315
16x16	201	2	000420316
17x17	212	2	000420317
18x18	222	2	000420318
19x19	233	2	000420319
21x21	254	1	000420321
22x22	264	1	000420322
24x24	285	1	000420324
27x27	290	1	000420327
30x30	320	1	000420330
32x32	340	1	000420332
36x36	360	1	000420336
38x38	430	1	000420338
41x41	430	1	000420341
46x46	480	1	000420343
50x50	520	1	000420345
55x55	560	1	000420347
60x60	595	1	000420350



42INOX/S11	1	000420391
6-8-10-11-12-13-14-15-16-17-19 mm		



42INOX/SC9	1	000420387
8-10-11-12-13-14-15-17-19 mm		
42/SCV9I	1	000420103

42INOX-AS

combination wrenches,
made of stainless steel



"	L mm		
1/4x1/4	95	1	000420356
5/16x5/16	116	1	000420358
3/8x3/8	137	1	000420360
7/16x7/16	148	1	000420361
1/2x1/2	169	1	000420363
9/16x9/16	180	1	000420364
5/8x5/8	201	1	000420366
11/16x11/16	212	1	000420367
3/4x3/4	233	1	000420369
13/16x13/16	254	1	000420371
7/8x7/8	264	1	000420372
15/16x15/16	285	1	000420373



42INOX-AS/S9	1	000420396
1/4-5/16-3/8-7/16-1/2-9/16-5/8-11/16-3/4		



96BPINOX

ball head offset hexagon key wrenches,
made of stainless steel



mm	L mm	L1 mm	Ø mm		
2	91	22	4	4	000961441
2,5	91	22	6	4	000961442
3	101	24	11	4	000961443
4	112	29	19	4	000961444
5	131	33	32	4	000961445
6	154	36	51	4	000961446
7	164	40	65	2	000961447
8	175	44	116	2	000961448
10	197	51	189	2	000961450



96BPINOX/B6	1	000961455
2,5-3-4-5-6-8 mm		
96BPINOX/B9	1	000961456
2-2,5-3-4-5-6-7-8-10 mm		
96BPINOX/BV	1	000961459

96BPINOX-AS

ball head offset hexagon key wrenches,
made of stainless steel



"	L mm	L1 mm	Ø mm		
5/64	91	22	5,5	4	000961989
3/32	91	22	5,3	4	000961990
7/64	101	24	10,5	4	000961991
1/8	101	24	10,7	4	000961992
9/64	112	29	18,7	4	000961993
5/32	112	29	18,7	4	000961994
3/16	131	33	31,5	2	000961995
7/32	154	36	50,0	2	000961996
1/4	164	40	70,0	2	000961997
5/16	175	44	115,0	2	000961998
3/8	197	51	186,5	2	000961999



96BPINOX-AS/B8	1	000962000
5/64-3/32-1/8-5/32-3/16-7/32-1/4-5/16		
96BPINOX/BV	1	000961459

96TINOX

offset hexagon key wrenches,
with high-torque handles,
made of stainless steel

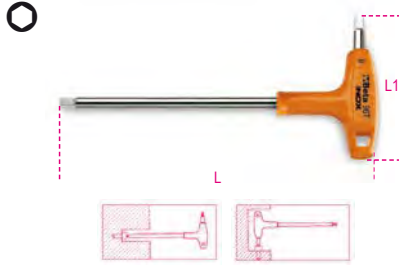

mm	L mm	L1 mm	
2,5	153	55	2 000961935
3	153	55	2 000961936
4	179	70	2 000961938
5	200	84	2 000961940
6	221	95	2 000961941
7	236	106	2 000961942
8	255	117	2 000961943
10	285	132	2 000961944



96TINOX/S5 2,5-3-4-5-6 mm	1 000961952
96TINOX/S8 2,5-3-4-5- 6-7-8-10 mm	1 000961954

96TINOX-AS

offset hexagon key wrenches,
with high torque handles,
made of stainless steel

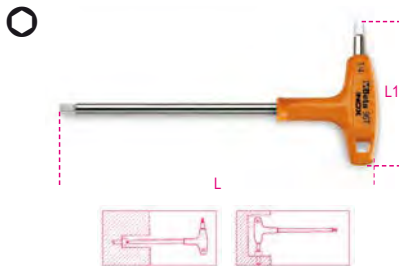

"	L mm	L1 mm	Ø mm	
3/32	153	55	3	2 000961861
7/64	153	55	4	2 000961862
1/8	179	70	4	2 000961863
9/64	179	70	5	2 000961864
5/32	200	84	6	2 000961865
3/16	200	84	6	2 000961866
7/32	221	103	7	2 000961867
1/4	236	106	8	2 000961868
5/16	255	117	10	2 000961869
3/8	285	132	12	2 000961870



96TINOX-AS/S7 3/32-1/8-5/32-3/16- 7/32-1/4-5/16	1 000961877
---	-------------

111INOX

adjustable wrenches,
made of stainless steel



DIN 3117 - ISO 6787

L mm	L "	A max mm	A1 mm	
150	6	18	45	1 001110315
200	8	24	58	1 001110320
250	10	30	70	1 001110325

362INOX

heavy-duty pipe wrenches,
made of stainless steel



L mm	Ø max mm	
300	58	1 003620430

920INOX-A

hexagon hand sockets,
made of stainless steel

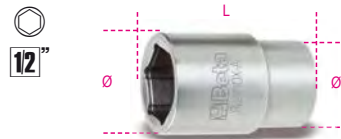

DIN 3124 - UNI ISO 2725

Ø mm	Ø mm	A mm	L mm	
8	15	10	40	2 009203008
9	16	10	40	2 009203009
10	17	10	40	2 009203010
11	18	11	40	2 009203011
12	19	11	40	2 009203012
13	20	11	40	2 009203013
14	21	11	40	2 009203014
15	23	11	40	2 009203015
16	24	11	40	2 009203016
17	25	11	40	2 009203017
18	26	13	42	2 009203018
19	28	13	42	2 009203019
20	29	13	42	1 009203020
21	30	13	43	1 009203021
22	31	15	43	1 009203022
24	34	15	43	1 009203024
27	38	18	46	1 009203027
30	42	20	46	1 009203030
32	44	20	46	1 009203032

920/55INOX

1/2" drive reversible ratchet,
72 teeth,
made of stainless steel



L mm	Ø mm	A mm	
264	40	43	1 009203882

920/R55INOX



920/R55INOX

1 009203879

1048INOX

slip joint pliers, boxed joints,
made of stainless steel

• 7-position model

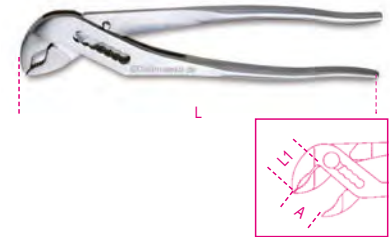

L mm	A max mm	L1 mm	
250	33	33	1 010480325

1082INOX

diagonal cutting nippers,
made of stainless steel



L mm	L1 mm	Ø mm	
150	20,0	1,6	1 010820350

1150INOX

heavy-duty combination pliers,
made of stainless steel
decentralized pin
open joint



L mm	L1 mm	
180	39	1 011500518

1153INOX

adjustable pliers, two positions,
made of stainless steel



L mm	L1 mm	
150	26	1 011530315

1290INOX

screwdrivers for slotted head screws
made of stainless steel

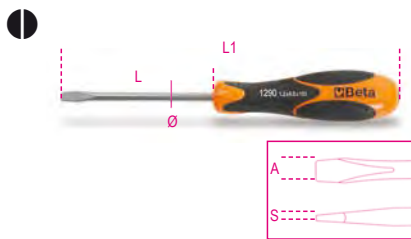

ISO 2380

SxAxL mm	L1 mm	Ø mm		
0,4x2,5x50	146	2.5	4	012900403
0,5x3x75	171	3.0	4	012900409
0,8x4x100	196	4.0	4	012900430
1,0x5,5x150	259	5.0	4	012900442
1,2x6,5x150	270	6.0	4	012900451

1292INOX

screwdrivers for cross head Phillips® screws,
made of stainless steel

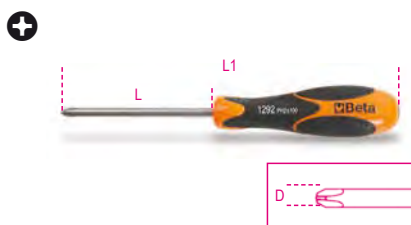

ISO 8764

PHxDxL mm	L1 mm		
0x3x60	156	4	012920403
1x4,5x80	189	4	012920409
2x6x100	220	4	012920418

1293INOX/D8

screwdriver set
made of stainless steel



1293INOX/D8 1 012930408

1290INOX	0,4x2,5x50-0,5x3x75 0,8x4x100-1,0x5,5x150- 1,2x6,5x150 mm
1292INOX	PH0x60-PH1x80 PH2x100 mm

1370INOX

engineer's hammer,
made of stainless steel

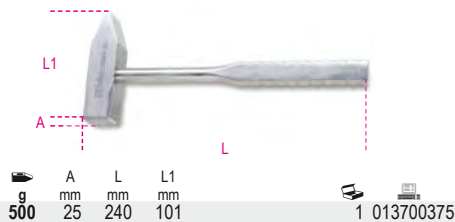

1377INOX

ball pein hammers,
round heads,
for coppersmiths and tinsmiths,
made of stainless steel

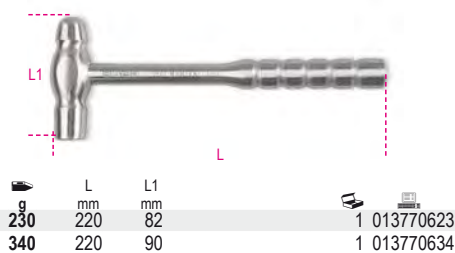

1730INOX

universal spatula,
made from stainless steel



C20TSS

five-section cantilever tool box, made of AISI
304 stainless steel



C20TSS 1 021203001

450x200x210 mm - 4kg

Beta

Beta

C04TSS-7

mobile roller cab with seven drawers, made entirely of stainless steel,
Non-marking wheels

Main features:

- Seven drawers (570 x 410 mm) with ball bearing slides;
- 6 drawers, 83 mm high;
- 1 drawer, 170 mm high;
- 4 castors Ø 125 mm
- 2 fixed and 2 steering (two with brakes);
- Front centralized lock;
- Frame made entirely of stainless steel AISI 304
- Castors, supports, ball bearings, drawer interiors and guides made of stainless steel
- Drawer handles made of aluminium

63 kg

Beta
INOX
STAINLESS STEEL

700
kg

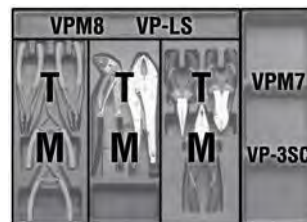

h	max
83 mm	25 kg
170 mm	30 kg

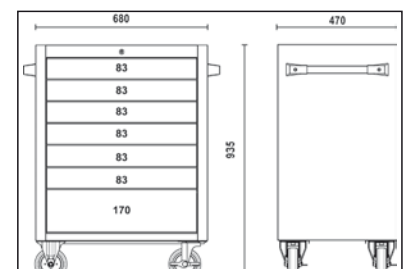
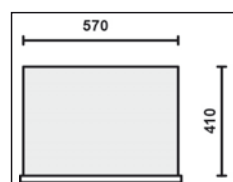



SPARK-PROOF TOOLS

Copper-Berillium Cu-Be

The **Beta** spark-proof tools are specially designed for safe operations in environments subject to potential risk of explosion, in the presence of flammable liquids or gases, or for any applications that require using perfectly antimagnetic, corrosion-resistant tools.



The Beta sparkproof tools are certified by the Federal Institute for Materials Research and Testing, BAM, under European Directive 99/92/EC.

CLASSIFICATION OF AREAS SUBJECT TO EXPLOSION RISK

		MEDIUM-LOW	EXTREMELY LOW
ATEX	GASES	ZONE 1 An area in which an explosive atmosphere consisting of a mixture of air and flammable substances in the form of gas, vapour or mist is likely to occur in normal operation.	ZONE 2 An area in which an explosive atmosphere consisting of a mixture of air and flammable substances in the form of gas, vapour or mist is not likely to occur in normal operation but, if it does occur, will persist for a short period only.
		ZONE 21 An area in which an explosive atmosphere in the form of a cloud of combustible dust in air is likely to occur in normal operation occasionally.	ZONE 22 An area in which an explosive atmosphere in the form of a cloud of combustible dust in air is not likely to occur in normal operation but, if it does occur, will persist for a short period only.



WARNING!
 Risk of explosion in **ACETYLENE** environment

The mechanical characteristics of sparkproof tools differ from those of normal steel tools. Sparkproof tools should be used with extreme caution, avoiding overloads.

30BA

sparkproof drift punches



Ø mm	L mm	S mm		
5	150	15	1	000300806
8	150	17	1	000300808
10	150	19	1	000300810

31BA

sparkproof pin punches



Ø mm	L mm		
3	110	1	000310853
4	110	1	000310854
6	115	1	000310856
8	120	1	000310858

31BA/C

sparkproof drift punches



Ø mm	Ø1 mm	L mm		
*6	12	150	1	000310876
*7	13	150	1	000310877
*12	18	175	1	000310882
*13	29	255	1	000310883

32BA

sparkproof centre punch



● mm	L mm		
14	150	1	000320811

34BA

sparkproof flat chisels



L mm	A mm		
200	22	1	000340801
250	24	1	000340803
300	25	1	000340802

39BA

sparkproof wedges



L mm	A mm		
150	40	1	000390801
230	40	1	000390802
250	40	1	000390803

42BA

sparkproof combination wrenches, open bi-hex ring ends



● mm	L mm		
6x6	105	1	000420806
7x7	105	1	000420807
8x8	120	1	000420808
9x9	120	1	000420809
10x10	135	1	000420810
11x11	135	1	000420811
12x12	150	1	000420812
13x13	150	1	000420813
14x14	175	1	000420814
15x15	175	1	000420815
16x16	195	1	000420816
17x17	200	1	000420817
18x18	215	1	000420818
19x19	220	1	000420819
20x20	230	1	000420820
21x21	240	1	000420821
22x22	250	1	000420822
24x24	268	1	000420824
26x26	290	1	000420826
27x27	290	1	000420827
28x28	290	1	000420828
30x30	313	1	000420830
32x32	333	1	000420832
34x34	360	1	000420834
35x35	360	1	000420835
36x36	355	1	000420836
38x38	430	1	000420838
41x41	430	1	000420841
46x46	480	1	000420846
50x50	520	1	000420850
55x55	560	1	000420855
60x60	580	1	000420860
*65x65	595	1	000420865
*70x70	630	1	000420870

42BA-AS

sparkproof combination wrenches, open bi-hex ring ends



● mm	L mm		
9/32x9/32	120	1	000420946
5/16x5/16	120	1	000420947
11/32x11/32	135	1	000420948
3/8x3/8	128	1	000420950
7/16x7/16	135	1	000420951
15/32x15/32	140	1	000420949
1/2x1/2	140	1	000420953
9/16x9/16	163	1	000420954

● mm	L mm		
*19/32x19/32	195	1	000420955
5/8x5/8	177	1	000420956
11/16x11/16	195	1	000420957
3/4x3/4	215	1	000420959
13/16x13/16	230	1	000420961
7/8x7/8	235	1	000420962
15/16x15/16	256	1	000420964
*31/32x31/32	265	1	000420963
1x1	266	1	000420965
1.1/16x1.1/16	283	1	000420967
1.1/8x1.1/8	297	1	000420969
1.3/16x1.3/16	308	1	000420970
1.1/4x1.1/4	324	1	000420973
*1.7/16x1.7/16	360	1	000420976

55BA

sparkproof double open end wrenches



● mm	L mm		
6x7	90	1	000550801
8x9	100	1	000550802
8x10	100	1	000550795
9x11	110	1	000550797
10x11	120	1	000550803
12x13	130	1	000550804
*12x14	130	1	000550846
13x14	133	1	000550799
14x15	145	1	000550805
14x17	150	1	000550806
16x17	165	1	000550807
17x19	170	1	000550847
18x19	170	1	000550809
*19x22	185	1	000550810
20x22	185	1	000550811
21x23	210	1	000550813
22x24	210	1	000550815
24x26	230	1	000550817
24x27	230	1	000550818
25x28	230	1	000550819
27x29	246	1	000550820
30x32	265	1	000550822
36x38	320	1	000550826
36x41	335	1	000550828
41x46	355	1	000550829
*46x50	370	1	000550830
*50x55	385	1	000550831
*55x60	415	1	000550832

55BA-AS

sparkproof double open end wrenches



● mm	L mm		
3/8x7/16	110	1	000550853
1/2x9/16	130	1	000550854
5/8x11/16	160	1	000550857
3/4x13/16	180	1	000550859
7/8x15/16	210	1	000550865
1x1.1/16	230	1	000550868
1.1/8x1.3/16	245	1	000550870
1.1/4x1.5/16	255	1	000550872

58BA

sparkproof open end slogging wrenches



mm	L mm		
17	125	1	000580817
19	125	1	000580819
22	135	1	000580822
24	150	1	000580824
27	165	1	000580827
30	180	1	000580830
32	190	1	000580832
*34	200	1	000580834
*36	210	1	000580836
38	220	1	000580838
41	230	1	000580841
46	240	1	000580846
50	255	1	000580850
*55	305	1	000580855
*60	315	1	000580860
*65	335	1	000580865
*70	370	1	000580870
*75	375	1	000580875
*80	400	1	000580880
*85	400	1	000580885
*90	445	1	000580890
*95	445	1	000580895
*100	485	1	000580900
*110	513	1	000580901

58BA-AS

sparkproof double open end slogging wrenches



mm	L mm	A mm	S mm		
*11/16	125	40,5	11,0	1	000580904
*3/4	125	40,5	11,0	1	000580905
*7/8	135	46,2	12,0	1	000580906
*15/16	150	50,3	12,0	1	000580907
*31/32	150	50,3	12,0	1	000580954
*1	175	56,9	15,0	1	000580908
*1.1/8	190	64,0	15,5	1	000580909
*1.1/4	190	64,0	15,5	1	000580910
*1.7/16	210	75,0	18,5	1	000580912
*1.1/2	220	82,0	18,5	1	000580913
*1.5/8	230	86,8	18,5	1	000580914
*1.3/4	250	98,0	20,	1	000580970

78BA

sparkproof bi-hex ring slogging wrenches



mm	L mm		
17	145	1	000780817
19	145	1	000780819
22	165	1	000780822
24	140	1	000780824
27	155	1	000780827
30	165	1	000780830
32	180	1	000780832
34	192	1	000780834
36	208	1	000780836
38	215	1	000780838
41	225	1	000780841
46	245	1	000780846
50	250	1	000780850
55	265	1	000780855
60	275	1	000780860
65	295	1	000780865
70	310	1	000780870

mm	L mm		
75	325	1	000780875
80	340	1	000780880
*85	355	1	000780885
*90	380	1	000780890
*95	390	1	000780895
*100	410	1	000780900
*105	420	1	000780903
*110	445	1	000780901
*120	480	1	000780902

78BA-AS

sparkproof bi-hex ring slogging wrenches



mm	L mm		
11/16	145	1	000780908
3/4	145	1	000780909
7/8	155	1	000780935
15/16	165	1	000780936
*31/32	165	1	000780937
1	175	1	000780938
*1.1/16	175	1	000780939
1.1/8	180	1	000780940
1.3/16	185	1	000780941
1.1/4	177	1	000780910
*1.5/16	200	1	000780954
*1.3/8	205	1	000780911
1.7/16	208	1	000780912
*1.1/2	215	1	000780913
*1.9/16	225	1	000780947
*1.11/16	225	1	000780962
1.5/8	225	1	000780914
*1.3/4	235	1	000780963
1.13/16	243	1	000780916
1.7/8	235	1	000780915
2	254	1	000780918
2.3/16	264	1	000780920
2.3/8	275	1	000780922
*2.9/16	286	1	000780924
*2.15/16	311	1	000780926
*3.1/8	325	1	000780928
*3.1/2	355	1	000780930

89BA

spark-proof single ring wrenches



mm	L mm		
10	200	1	000890810
11	210	1	000890811
12	220	1	000890812
13	230	1	000890813
14	240	1	000890814
16	260	1	000890816
17	270	1	000890817
18	280	1	000890818
19	300	1	000890819
20	310	1	000890820
22	330	1	000890822
24	350	1	000890824
27	370	1	000890827
30	400	1	000890830
32	420	1	000890832

90BA

sparkproof double ended offset ring wrenches



mm	L mm		
6x7	122	1	000900801
8x9	128	1	000900802
10x11	155	1	000900803
12x13	175	1	000900806
12X14	180	1	000900807
14x15	200	1	000900808
14x17	220	1	000900809
16x17	230	1	000900811
16x18	235	1	000900812
17X19	250	1	000900814
18x19	265	1	000900815
19x22	280	1	000900817
20x22	295	1	000900818
21x23	298	1	000900820
22x24	315	1	000900821
24x26	333	1	000900822
24x27	340	1	000900823
30x32	395	1	000900824
34x36	410	1	000900826
*36x41	450	1	000900828
*41x46	470	1	000900829
*46x50	490	1	000900830

91BA

sparkproof heavy duty offset ring wrenches



mm	Ø mm		
24	38	1	000910824
27	42	1	000910827
30	48	1	000910830
32	49	1	000910832
36	54	1	000910836
41	62	1	000910841
*46	69	1	000910846
*50	75	1	000910850
*55	82	1	000910855

92BA

sparkproof tubes for item 91BA



	L mm	91BA mm	Ø mm		
92BA/1	460	24÷30	25	1	000920810
92BA/2	610	32÷41	28	1	000920820
*92BA/3	760	46÷55	32	1	000920830

93BA

ratcheting double-ended offset ring wrench for scaffolding bolts, sparkproof



mm	L mm		
21x22	345	1	000930821

95BA

double ended flat ring wrenches, sparkproof



mm	L mm		
7x9	115	1	000950801
8x10	115	1	000950802
10x11	140	1	000950804
10x12	140	1	000950805
12x14	145	1	000950806
14x17	165	1	000950807
*16x18	170	1	000950809
*17x19	185	1	000950808
*18x19	185	1	000950810
*19x22	200	1	000950812
*21x23	230	1	000950815
*24x27	255	1	000950817
*30x32	295	1	000950820

96BA

sparkproof offset hexagon key wrenches



mm	L mm	L1 mm		
1,5	50	17	1	000960760
2	50	16	1	000960762
2,5	56	20	1	000960761
3	63	21	1	000960763
4	69	25	1	000960764
5	78	29	1	000960765
6	88	33	1	000960766
7	93	34	1	000960767
8	97	36	1	000960768
9	104	37	1	000960769
10	110	39	1	000960770
12	122	44	1	000960772

96BA/BP

ball head offset hexagon key wrenches, sparkproof



mm	L mm	L1 mm		
1,5	50	16	1	000961800
2	50	16	1	000961801
2,5	63	20	1	000961802
3	60	20	1	000961803
3,5	70	25	1	000961799
4	66	25	1	000961804
5	75	28	1	000961805
6	84	32	1	000961806
8	92	36	1	000961808
10	102	40	1	000961810
12	113	45	1	000961812

96BAF-AS

sparkproof offset hexagon key wrenches



mm	L mm	L1 mm		
*1/16	59	25	1	000962831
*5/64	59	25	1	000962832
*3/32	59	25	1	000962833
*7/64	59	25	1	000962834
*1/8	59	25	1	000962835
*9/64	64	29	1	000962836
*5/32	65	30	1	000962837
*3/16	79	31	1	000962838
*7/32	85	37	1	000962839
*1/4	85	37	1	000962840
*5/16	92	44	1	000962842
*3/8	110	45	1	000962844
*7/16	119	48	1	000962845
*1/2	140	55	1	000962846

99BA

sparkproof hook wrenches with square noses, for ring nuts UNI/ISO 2982, 2983



mm	A mm		
32-75	4,0	1	000990803
50-120	4,5	1	000990805
115-170	4,5	1	000990811

110BA

sparkproof adjustable wrenches



L mm	A max mm		
100	13	1	001100810
150	18	1	001100815
200	24	1	001100820
250	30	1	001100825
300	36	1	001100830
375	46	1	001100837
*450	55	1	001100845
*600	65	1	001100860

330BA

sparkproof pipe cutters for gas pipes



330BA/2	Ø max mm	L mm		
	50 mm	375	1	003300802
	2"			

330BA/2R

spare pin and knife for gas pipe cutter 330BA, sparkproof



330BA /2-R		
	1	003300822

363BA

sparkproof heavy duty pipe wrenches



L mm	Ø max mm	Ø max mm		
150	1 1/2" gas	20	1	003630815
200	1" gas	30	1	003630820
250	1 1/2 gas	49	1	003630825
300	2" gas	60	1	003630830
350	2" gas	60	1	003630835
450	2 1/2 gas	76	1	003630845
600	3" gas	90	1	003630860

378BA

sparkproof pipe wrench, Swedish pattern, made from copper/beryllium alloy



L mm	Ø max "		
430	1" 1/2 gas	1	003780800
530	2" gas	1	003780801

386BA

sparkproof heavy duty reversible chain pipe wrenches

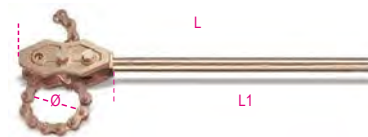

L mm	Ø max mm	L1 mm		
600	100	470	1	003860806
900	200	750	1	003860809

911BA

bi-hex hand sockets, spark-proof

38



mm	L mm		
6	28	1	009110806
7	28	1	009110807
8	28	1	009110808
9	28	1	009110809

mm	L mm		
10	32	1	009110810
11	32	1	009110811
12	32	1	009110812
13	32	1	009110813
14	32	1	009110814
15	32	1	009110815
16	32	1	009110816
17	32	1	009110817
18	32	1	009110818
19	32	1	009110819

911BA/16

adaptor, 3/8" female and 1/2" male drives, spark-proof

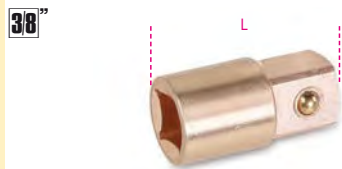

L mm	mm	mm		
34	3/8	1/2	1	009110836

911BA/20

extension bar, 3/8" male and female drives, spark-proof



L mm				
75			1	009110840

911BA/55

3/8" push-through drive ratchet, spark-proof

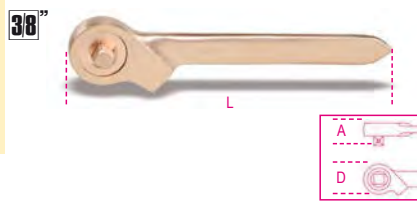

L mm	D mm	A mm		
200	45	16.5	1	009110882

921BA

sparkproof bi-hex sockets

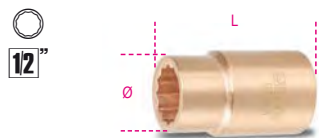

mm	Ø mm	L mm		
8	24,0	40	1	009210808
9	24,0	40	1	009210809
10	16,5	40	1	009210810
11	17,5	40	1	009210811
12	18,5	40	1	009210812
13	19,5	40	1	009210813
14	20,0	40	1	009210814
15	21,5	40	1	009210815

mm	Ø mm	L mm		
16	24,0	40	1	009210816
17	25,0	40	1	009210817
18	25,0	40	1	009210818
19	28,0	42	1	009210819
20	29,0	42	1	009210820
21	30,0	43	1	009210821
22	30,5	43	1	009210822
24	34,0	43	1	009210824
25	36,0	43	1	009210825
26	37,5	43	1	009210826
27	37,5	45	1	009210827
28	38,9	46	1	009210828
30	41,5	46	1	009210830
32	43,5	46	1	009210832

921BA-AS

sparkproof bi-hex sockets

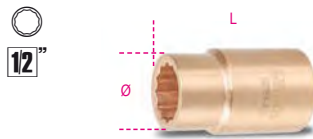

"	Ø mm	L mm		
5/16	24,0	40	1	009210958
3/8	24,0	40	1	009210960
7/16	24,0	40	1	009210961
1/2	24,0	40	1	009210963
9/16	24,0	40	1	009210964
5/8	25,0	40	1	009210966
11/16	25,5	40	1	009210967
3/4	28,0	42	1	009210969
13/16	30,0	43	1	009210971
7/8	31,5	43	1	009210972
15/16	34,0	43	1	009210974
1	36,0	43	1	009210975
1.1/16	38,0	46	1	009210977
1.1/4	42,0	46	1	009210982
1.7/16	50,5	50	1	009210986

921BA/15

adaptor, 1/2" female and 3/8" male drives, spark-proof



L mm	mm	mm		
34	1/2	3/8	1	009210839

921BA/21 - 921BA/22

sparkproof 1/2" wobble extension bars



	L mm	Ø mm		
921BA/21	125	30	1	009210842
921BA/22	250	31	1	009210844

921BA/25

sparkproof 1/2" drive universal joint



L mm	Ø mm	mm	mm		
80	25	1/2	1/2	1	009210845

921BA/42

sparkproof 1/2" drive sliding T handle



L mm				
250			1	009210846

921BA/50

sparkproof 1/2" drive push-through square ratchet



L mm	D mm	A mm		
250	45	16,5	1	009210850

921BA/R50

sparkproof spare set



L mm				
1/2"			1	009210851

926BA

sparkproof bi-hex hand sockets

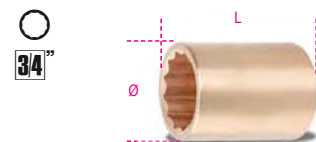

mm	Ø mm	L mm		
22	40	55	1	009260822
24	40	55	1	009260824
26	40	55	1	009260826
27	40	55	1	009260827
28	41	55	1	009260828
30	43	60	1	009260830
32	45	60	1	009260832
34	48	60	1	009260834
36	50	60	1	009260836
38	53	60	1	009260838
41	57	65	1	009260841
46	63	65	1	009260846
50	68	70	1	009260850

926BA/22

sparkproof 3/4" drive extension bars



926BA/22	L mm	Ø mm	1	009260872
	200	38		

926BA/42

sparkproof 3/4" drive slide T-handle

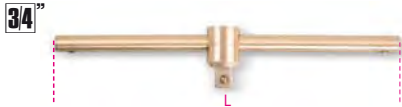

926BA/42	L mm	1	009260876
	400		

926BA/50

sparkproof 3/4" push-through drive ratchet



926BA/50	L mm	D mm	A mm	1	009260880
	300	61	22		

926BA/R50

sparkproof spare set



926BA/R50	1	009260881

937BA

hexagon socket wrenches, sparkproof



937BA	L mm	A mm	1	009370813
13	240	45		
17	260	51		
19	270	55		
22	278	59		
24	286	63		
27	294	69		
30	302	75		
32	310	81		
*36	330	85		
*41	350	90		

951BA

T-handle wrenches with hexagon male ends, sparkproof

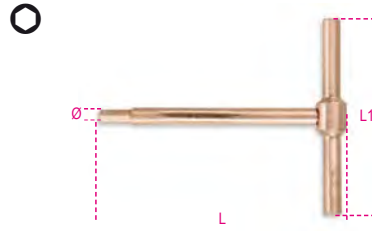

951BA	L mm	L1 mm	1	009510904
4	100	90		
5	100	90		
6	100	90		

961BA

sparkproof scrapers



961BA	L mm	A mm	1	009610802
	250	39		
	350	55		

963BA

sparkproof pry bars with pointed and flat bent ends



963BA	L mm	A mm	1	009630801
500	24			
*800	24			
*1000	30			

964BA

sparkproof wrench bungs



964BA	L mm	1	009640801
	385		

964BA/L

universal shears for barrels, sparkproof
For opening edged metal barrels



964BA/L	L mm	1	009640821
	510		

965BA

safety valve wrenches, sparkproof



965BA	A mm	A1 mm	L mm	1	009650830
30	44	200			
32	50	300			
35	47	250			
40	50	300			
45	58	350			
48	62	375			
50	67	400			
55	73	450			
60	79	500			
*65	82	550			
*70	85	600			

966BA

sparkproof safety valve wrench

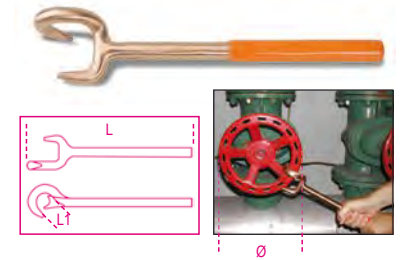

966BA	L mm	L1 mm	Ø min+max mm	1	009660801
	350	40	50±150		

966BA/V

sparkproof safety valve wrenches

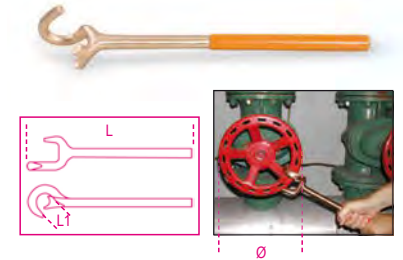

966BA/V	L mm	L1 mm	Ø min+max mm	1	009660812
	370	36	125±250		
	430	48	250±400		

1032BA

sparkproof internal circlip pliers, straight pattern, PVC-coated handles



1032BA	L mm	Ø mm	1	010320820
	200	40±100		

1036BA

sparkproof external circlip pliers, straight pattern, PVC-coated handles



L mm	mm	
200	40=100	1 010360820

1046BA

sparkproof slip joint pliers



L mm	A max mm	
250	32	1 010460801
★300	52	1 010460803

1052BA

adjustable self-locking pliers, concave jaws, sparkproof

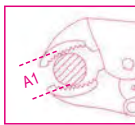

L mm	A1 max mm	
225	40,0	1 010520824

1082BA

sparkproof diagonal cutting nippers

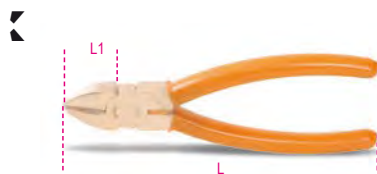

L mm	L1 mm	
160	22	1 010820801

1100BA

bolt cutters, spark-proof



L mm		
600		1 011000860

1137BA

blasting pliers



L mm	L1 mm	
185	30	1 011370801

1137BA/RC

spare blade for item 1137BA



1137BA/RC		1 011370851
-----------	--	-------------

1150BA

sparkproof combination pliers

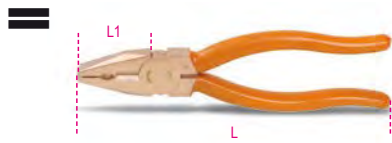

L mm	L1 mm	
200	40	1 011500820

1162BA

sparkproof extra-long flat knurled nose pliers



L mm	L1 mm	
150	54	1 011620815

1166BA

sparkproof extra-long needle knurled nose pliers



L mm	L1 mm	
150	54	1 011660815

1270BA

sparkproof screwdrivers for slotted head screws



AxL mm	L1 mm	
3x75	178	1 012700803
4x100	209	1 012700804
5x150	250	1 012700805
6x150	270	1 012700806
10x250	382	1 012700810
8x200	312	1 012700808

1272BA

sparkproof screwdrivers for cross head Phillips® screws



PHxDxL mm	L1 mm	
1x5x100	209	1 012720801
2x6x150	270	1 012720802
3x8x200	332	1 012720803

1277BA

screwdrivers for Torx® head screws, sparkproof



Ø	L mm	L1 mm	Ø mm	
T10	75	184	5	1 012770810
T15	75	184	5	1 012770815
T20	100	209	6	1 012770820
T25	125	209	6	1 012770825
T30	150	270	6	1 012770830
T40	200	332	8	1 012770840

1370BA

sparkproof engineer's hammers, wooden shafts



g	A mm	L mm	L1 mm		
500	30	310	108	1	013700805
1000	35	340	137	1	013700810

1370BA/MR

spare shafts for item 1370BA

1370BA/MR 500	1	013700865
1370BA/500		
1370BA/MR 1000	1	013700870
1370BA/1000		

1370BA/PL

sparkproof engineer's hammers, fibre shafts



g	A mm	L mm	L1 mm		
500	30	310	108	1	013700815
1000	35	340	137	1	013700820

1375BA/PL

sparkproof ball pein and claw hammer, wooden shaft



g	L mm	L1 mm	Ø mm		
680	321	125	30	1	013750800

1377BA

sparkproof ball pein hammer, round head, for coppersmiths and tinsmiths



g	L1 mm	L mm		
340	90	280	1	013770834

1377BA/PL

sparkproof ball pein hammer, round head, for coppersmiths and tinsmiths



g	L1 mm	L mm		
340	90	280	1	013770884

1379BA

sparkproof scraping hammer, wooden shaft



g	L1 mm	L mm		
500	142	315	1	013790850

1380BA

sparkproof lump hammers, wooden shafts



g	L1 mm	L mm		
1000	100	400	1	013800810
1500	118	400	1	013800815
2000	126	400	1	013800820

1380BA/MR

spare shafts for item 1380BA

1380BA/MR 1000	1	013800860
1380BA/1000		
1380BA/MR 1500	1	013800865
1380BA/1500		
1380BA/MR 2000	1	013800870
1380BA/2000		

1380BA/PL

sparkproof mason club hammers, fibre shafts



g	L1 mm	L mm		
500	80	310	1	013800955
1000	94	350	1	013800960
1500	115	400	1	013800965
2000	125,5	400	1	013800970

1381BA

sparkproof sledge hammers, wooden shafts



g	L1 mm	L mm		
5000	179	900	1	013810850
*8000	190	900	1	013810858

1381BA/MR

spare shaft for item 1381BA

1381BA/MR 5000	1	013810870
1381BA/5000		
*1381BA/MR 8000	1	013810878
1381BA/8000		

1381BA/PL

sparkproof sledge hammers, fibre shafts



g	L1 mm	L mm		
5000	172	900	1	013810885
8000	204	900	1	013810888

1390BA

spark-proof soft face hammer



Ø mm	L mm	L1 mm		
*52	370	130	1	013900805



1390BA/R

spare nylon faces for item 1390BA



D			
mm	52	4	013900885

1602BA

sparkproof crimping pliers for insulated terminals, lightweight series



$\frac{1}{2}$	L		
mm ²	0.75÷6	mm	200
			1 016020801

1701BA

sparkproof hexagon chisels



L	A	S	
mm	mm	mm	
150	12	10	1 017010810
200	16	14	1 017010814
250	18	14	1 017010815
350	19	17	1 017010817

1703BA/A

sparkproof axe



L	L1	A	
mm	mm	mm	
340	145	82	1 017030082

1703BA/P

sparkproof pick



A	L	L1	
mm	mm	mm	
56	1050	410	1 017030150

1703BA/PL

sparkproof shovel

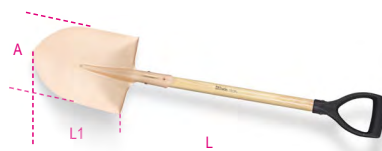

A	L1	L	
mm	mm	mm	
240	420	990	1 017030200

1717BA

sparkproof rigid spatulas



A			
mm	60		1 017170801
	80		1 017170803

1717BA/1

sparkproof wall scraper



A	L		
mm	mm		
100	220		1 017170805

1719BA8

sparkproof files, 8"



	L		
	mm		
1719BA8/P	200		1 017190801
1719BA8/M	200		1 017190805
1719BA8/R	200		1 017190810
1719BA8/T	200		1 017190815
1719BA8/Q	200		1 017190820

1719BA12

sparkproof files, 12"



P	L		
	mm		
1719BA12/P	300		1 017190831

1727BA

sparkproof hacksaw and blade



L	L1		
mm	mm		
500	300		1 017270801

1728BA

spark-proof blades for hacksaw frames, made from copper-beryllium alloy



L			
mm	300		1 017280801

1737BA

brush with sparkproof wires



L	A		
mm	mm		
294	29		1 017370801

1758BA

sparkproof funnel



Ø	H		
mm	mm		
160	150		1 017580815

1776BA

sparkproof knife



L1	L		
mm	mm		
145	250		1 017760801

1784BA

sparkproof scissors



L			
mm	225		1 017840822

1972/12

ultracompact drill, 12V

- ultracompact, no more than 176 mm in length; ultralightweight, no more than 1.1 kg, with battery, perfectly balanced
- double mechanical speed with steel gears and 18-position clutch
- torque up to 34 Nm and 1500 rpm (350 rpm in 1st gear); drills diameters up to 10 mm in steel and 20 mm in wood
- 2Ah batteries and charge indicator on drill body
- triple battery self-protection (heat, overload and monitoring of charge differences (if any) between cells) for increased safety and durable high performance
- ergonomic nonslip handle
- front LED
- 10-mm autochuck
- belt clip (right/left side)
- selector switch, screwing-unscrewing-locking modes (for transportation)
- supplied in a hard case with 2 lithium ion batteries (2 Ah) and quick charger (45 min)

1,1 kg

AVAILABLE ONLY IN EMEA REGIONS

1972/12

019720012



1984/18QM

reversible impact wrench, 18V, brushless

digital brushless motor: remarkably enhanced performance, including: increased power, reduced energy consumption, extended useful motor life, outstanding compactness, improved power proportioning from push button.

- 5Ah batteries with charge indicator
- ultracompact: no more than 196 mm in length
- 1/2" male drive with bush retaining ring
- belt clip (right/left side)
- triple front LED
- gearcase made entirely of metal
- selector switch, screwing-unscrewing-locking modes (for transportation)
- ergonomic nonslip handle
- triple battery self-protection (heat, overload and monitoring of charge differences (if any) between cells) for increased safety and durable high performance

4 modes available:

1: 270Nm; 1400 RPM

2: 360Nm; 2000 RPM

3: 450Nm; 2750 RPM

A: 450Nm Autostop - as long as the impact wrench detects a free rotation, it applies maximum torque/speed (450Nm; 2750 RPM)

when the nut reaches the end of stroke and stops rotating, the impact wrench keeps applying maximum torque for 1 second; then it sets itself to the lowest level, to avoid damaging the nut

- supplied in a hard case with hexagon bit holder adaptor (1/4"), 2 lithium ion batteries (5 Ah) and quick charger (80 min)

2,3 kg

AVAILABLE ONLY IN EMEA REGIONS

1984/18QM

019840018





PNEUMATIC TOOLS

For over 20 years Beta Utensili has supplemented its products with a comprehensive range of pneumatic tools and accessories developed for the automotive and industrial maintenance markets: impact wrenches, ratchets, drills, grinders, sanders and many more items.

During this period close co-operation with professional users has been key to ongoing growth. It is on the basis of such growth that Beta's pneumatic tools can boast an excellent reliability/performance ratio.

In order to satisfy market requirements in the best possible way, Beta Utensili repairs the pneumatic tools in its Quality Department.

This process has allowed the company to improve its know-how to a significant extent and become increasingly responsive to the customer base.

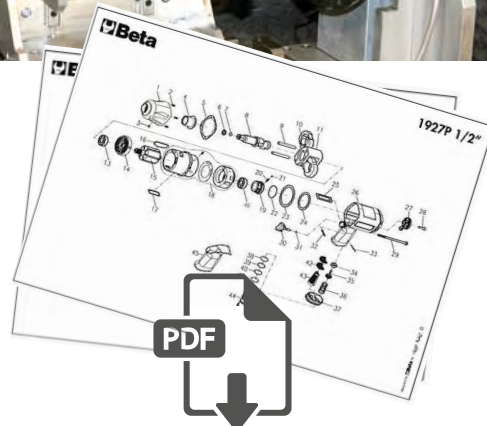
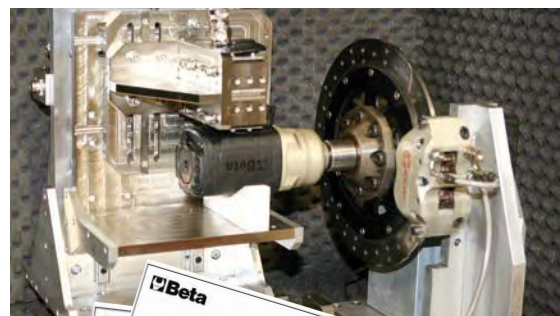



























PDF

www.beta-tools.com



GUIDE TO CHOOSING PNEUMATIC TOOLS

IMPACT WRENCHES

■	BETA ITEM	N °.	MATERIAL	 max. Nm	 db (A) LpA	 db (A) LpW	 l/min.	 kg	MECHANISM	 m/s ²
3/8"		1924F	Aluminium	108	93.6	104.6	59	0,5	Double hammer	6.85
3/8"		1924B	Aluminium	353	91	95	80	1,5	Pin clutch	7.9
3/8"		1924CD	Composite material	410	91.7	102.7	79	1,3	Double hammer	6.2
1/2"		1927AN	Aluminium	244	89.4	100.4	190	2,1	Single hammer	8.63
1/2"		1927G	Aluminium	325	92.2	103.2	113	1,2	Single hammer	9.96
1/2"		1927B	Aluminium	705	98.0	109.0	133	2,1	Pin clutch	14.08
1/2"		1927XM	Aluminium	770	102	113	122	1,3	Single hammer	7.5
1/2"		1927CD	Composite material	1.020	95.5	106.5	130	2,3	Double hammer	7.2
1/2"		1927P	Composite material	1.750	95.1	106.1	290	2,0	Double hammer	6.7
3/4"		1928XM	Aluminium	1.600	91.8	102.8	175	2,9	Double hammer	12.96
3/4"		1928DA	Aluminium	1.695	96	99.5	300	4,3	Double hammer	3.6
3/4"		1928DAL	Aluminium	1.695	96	99.5	300	4,8	Double hammer	3.6
3/4"		1928CD	Composite material	1.800	97.5	108.5	215	3,5	Double hammer	11.4
1"		1930CD	Composite material	2.445	95.6	97.1	410	7,1	Double hammer	3,6
1"		1930PA	Aluminium	2.445	96.0	97.1	410	9,6	Double hammer	7,2
1"		1930A	Aluminium	2.445	103.3	114.3	460	9,5	Double hammer	67
1"		1930LH	Aluminium	2.441	97.1	108.1	282	7,1	Double hammer	17.4
1"		1930LA	Aluminium	2.445	95.6	97.1	460	10,6	Double hammer	3,6
1"		1930HLA	Aluminium	3.661	99	101	460	16,4	Double hammer	16,4
1 1/2"		1930ZL	Aluminium	4.068	102.4	113.4	480	15	Double hammer	69.6

GUIDE TO CHOOSING PNEUMATIC TOOLS

AIR IMPACT RATCHETS

■	BETA ITEM	N°.	 max. Nm	 db (A) LpA	 db (A) LpW	 l/min.	 kg	 m/s ²
1/4"		1921B1	24	96	85	90	0,4	2.6
1/4"		1921M1	27	84	88	96	0,6	1.8
1/4"		1922P1	68	90.6	101.6	88	0,6	8.61
3/8"		1921M2	27	84	88	96	0,6	1.8
3/8"		1922P2	68	90.6	101.6	88	0,6	8.61
1/2"		1921N3	68	80	87	140	1,2	2.6
1/2"		1922P3	136	94.9	105.9	113	1,5	18.28

GRINDERS

	BETA ITEM	N°.	POWER	 db (A) LpA	 db (A) LpW	 l/min.	 kg	 m/s ²
		1933	0,20 kW	80.0	87.0	230	0,38	4.53
		1933L	0,20 kW	80.0	87.0	270	0,67	1.15
		1933AN90	0,20 kW	80.0	87.0	230	0,51	1.24
		1933I	0,38 kW	80.0	87.0	260	0,67	4.53
		1933IL	0,38 kW	79.0	97.0	113	1,4	1.6
		1933IH	0,75 kW	88.1	99.1	370	0,8	2.6
		1933ILH	0,75 kW	85.7	96.7	370	1,2	1.4
		1933AN90-H	0,75 kW	85.6	96.6	370	1,1	6.7
		1934MAV	0,04 kW	71	76	115	0,2	2.5
		1934MAV70	0,08 kW	80	87	115	0,2	4

1921B1

baby reversible air ratchet

1/4"

CE



130 mm

Free speed	350 rpm
Max. torque	24 Nm
Bolt capacity	Cl 8.8 M7●11 mm
Bolt capacity	Cl 12.9 M6●10 mm
Air inlet	1/4" GAS
Working pressure	6.2 bar
Internal hose size (Ø)	8 mm
Mean air consumption	68 l/min
Weight	0,4 kg

1/4"	kg	1	019210001
------	----	---	-----------

1921N3

reversible air ratchet

1/2"

CE



258 mm

Free speed	150 rpm
Max. torque	68 Nm
Bolt capacity	Cl 8.8 M10●16 mm
Bolt capacity	Cl 12.9 M8●13 mm
Air inlet	1/4" GAS
Working pressure	6.2 bar
Internal hose size (Ø)	10 mm
Mean air consumption	140 l/min
Weight	1.2 kg

1/2"	kg	1	019210025
------	----	---	-----------

1922P3

reversible air impact ratchet

1/2"

CE



292 mm

Free speed	600 rpm
Maximum torque	136 Nm
Bolt capacity	Cl 8.8 M12●18 mm
Bolt capacity	Cl 12.9 M10●16 mm
Air inlet	1/4" GAS
Working pressure	6.2 bar
Internal hose size (Ø)	10 mm
Mean air consumption	113 l/min
Weight	1.5 kg

1/2"	kg	1	019220013
------	----	---	-----------

1921M1

compact reversible air ratchet

• Knob speed regulator

1/4"

CE



198 mm

Free speed	200 rpm
Max. torque	27 Nm
Bolt capacity	Cl 8.8 M7●11 mm
Bolt capacity	Cl 12.9 M6●10 mm
Air inlet	1/4" GAS
Working pressure	6.2 bar
Internal hose size (Ø)	8 mm
Mean air consumption	96 l/min
Weight	0.6 kg

1/4"	kg	1	019210005
------	----	---	-----------

1922P1

reversible air impact ratchet

• "Double rocking dog" impulse device

1/4"

CE



164 mm

Free speed	700 rpm
Maximum torque	68 Nm
Bolt capacity	Cl 8.8 M10●16 mm
Bolt capacity	Cl 12.9 M8●13 mm
Air inlet	1/4" GAS
Working pressure	6.2 bar
Internal hose size (Ø)	10 mm
Mean air consumption	88 l/min
Weight	0.6 kg

1/4"	kg	1	019220006
------	----	---	-----------

1924F

butterfly compact reversible impact wrench

• "Double rocking dog" impulse device

3/8"

CE



139 mm

Free speed	12,000 rpm
Maximum torque	108 Nm
Bolt capacity	Cl 8.8 M12●18 mm
Bolt capacity	Cl 12.9 M10●16 mm
Air inlet	1/4" GAS
Working pressure	6.2 bar
Internal hose size (Ø)	10 mm
Mean air consumption	59 l/min
Weight	0.5 kg

3/8"	kg	1	019240025
------	----	---	-----------

1921M2

compact reversible air ratchet

• Knob speed regulator

3/8"

CE



198 mm

Free speed	200 rpm
Max. torque	27 Nm
Bolt capacity	Cl 8.8 M7●11 mm
Bolt capacity	Cl 12.9 M6●10 mm
Air inlet	1/4" GAS
Working pressure	6.2 bar
Internal hose size (Ø)	8 mm
Mean air consumption	96 l/min
Weight	0.6 kg

3/8"	kg	1	019210015
------	----	---	-----------

1922P2

reversible air impact ratchet

• "Double rocking dog" impulse device

3/8"

CE



164 mm

Free speed	700 rpm
Maximum torque	68 Nm
Bolt capacity	Cl 8.8 M10●16 mm
Bolt capacity	Cl 12.9 M8●13 mm
Air inlet	1/4" GAS
Working pressure	6.2 bar
Internal hose size (Ø)	10 mm
Mean air consumption	88 l/min
Weight	0.6 kg

3/8"	kg	1	019220010
------	----	---	-----------



1924B

compact reversible impact wrench

- "Pin Clutch" impulse device



Free speed	10,000 rpm
Max. torque	353 Nm
Bolt capacity	Cl 8.8 M16 ● 24 mm
Bolt capacity	Cl 12.9 M14 ● 21 mm
Air inlet	1/4" GAS
Working pressure	6,2 bar
Internal hose size (Ø)	8 mm
Mean air consumption	80 l/min
Weight	1,5 kg

3/8	kg	1	019240021
1,5			

1927CD

reversible impact wrench,
made from composite material

- Double hammer impulse device

NOT AVAILABLE IN THE USA



Free speed	7,000 rpm
Max. torque	1.020 Nm
Bolt capacity	Cl 8.8 M22 ● 34 mm
Bolt capacity	Cl 12.9 M18 ● 27 mm
Air inlet	1/4" GAS
Working pressure	6,2 bar
Internal hose size (Ø)	10 mm
Mean air consumption	130 l/min
Weight	1,9 kg

1/2	kg	1	019270007
2,3			

1927XM

compact reversible impact wrench

- Single hammer impulse device



Free speed	10,000 rpm
Max. torque	770 Nm
Bolt capacity	Cl 8.8 M22 ● 34 mm
Bolt capacity	Cl 12.9 M18 ● 27 mm
Air inlet	1/4" GAS
Operating pressure	6,2 bar
Internal hose size (Ø)	10 mm
Mean air consumption	122 l/min
Weight	1,3 kg

1/2	kg	1	019270030
1,3			

1924CD

reversible impact wrench,
made from composite material

- Double hammer impulse device

NOT AVAILABLE IN THE USA



Free speed	10,000 rpm
Max. torque	410 Nm
Bolt capacity	Cl 8.8 M16 ● 24 mm
Bolt capacity	Cl 12.9 M14 ● 21 mm
Air inlet	1/4" GAS
Working pressure	6,2 bar
Internal hose size (Ø)	8 mm
Mean air consumption	79 l/min
Weight	1,3 kg

3/8	kg	1	019240007
1,3			

1927P

reversible impact wrench, made from
composite material

- Double hammer impulse device



Free speed	7,500 rpm
Max. torque	1.750 Nm
Bolt capacity	Cl 8.8 M24 ● 36 mm
Bolt capacity	Cl 12.9 M20 ● 30 mm
Air inlet	1/4" GAS
Operating pressure	6,2 bar
Internal hose size (Ø)	10 mm
Mean air consumption	290 l/min
Weight	2 kg

1/2	kg	1	019270008
2,0			

1927B

reversible impact wrench

- "Pin Clutch" impulse device



Free speed	7,000 rpm
Max. torque	705 Nm
Bolt capacity	Cl 8.8 M22 ● 34 mm
Bolt capacity	Cl 12.9 M18 ● 27 mm
Air inlet	1/4" GAS
Operating pressure	6,2 bar
Internal hose size (Ø)	10 mm
Mean air consumption	133 l/min
Weight	2,1 kg

1/2	kg	1	019270022
2,1			

1927AN

Angle reversible impact wrench

- Single hammer impulse device

12"

CE



Max. torque	244 Nm
Bolt capacity	244 Nm
Bolt capacity	CI 8.8 M14 ● 21 mm
Air inlet	CI 12.9 M12 ● 19 mm
Operating pressure	1/4" GAS
Internal hose size (Ø)	6,2 bar
Mean air consumption	10 mm
Weight	2.1 kg

1/2"	kg	1	019270012
2,1			

1927G

compact reversible impact wrench

- Single hammer impulse device

12"

CE



Free speed	9500 rpm
Max. torque	325 Nm
Bolt capacity	CI 8.8 M16 ● 24 mm
Bolt capacity	CI 12.9 M14 ● 21 mm
Air inlet	1/4" GAS
Operating pressure	6,2 bar
Internal hose size (Ø)	10 mm
Mean air consumption	122 l/min
Weight	1.2 kg

1/2"	kg	1	019270050
1,2			

1927SP-AM

magnetic support for pneumatic impact wrench

- Fitted with two high-powered magnets with protective rubber tops
- Can accommodate 1 1/2" impact wrench, 4 sockets and 1 torque wrench
- Capacity: 10 kg



400 g	1	019270000
-------	---	-----------

1928XM

compact reversible impact wrench

- Double hammer impulse device
- Amazingly compact and powerful
- One-hand reverse button
- Three power adjustable screwing positions
- Exhaust through handle

3/4"

CE



Free speed	4,800 rpm
Max. torque	1,600 Nm
Bolt capacity	CI 8.8 M27 ● 41 mm
Bolt capacity	CI 12.9 M24 ● 36 mm
Air inlet	3/8" GAS
Operating pressure	6,2 bar
Internal hose size (Ø)	10 mm
Mean air consumption	175 l/min
Weight	2.9 kg

3/4"	kg	1	019280030
2,9			

1928CD

reversible impact wrench,
made from composite material

- Double hammer impulse device

NOT AVAILABLE IN THE USA

3/4"

CE



Free speed	4,500 rpm
Max. torque	1,800 Nm
Bolt capacity	CI 8.8 M27 ● 41 mm
Bolt capacity	CI 12.9 M24 ● 36 mm
Air inlet	3/8" GAS
Working pressure	6,2 bar
Internal hose size (Ø)	10 mm
Mean air consumption	215 l/min
Weight	3,5 kg

3/4"	kg	1	019280007
3,5			

1928DA

reversible impact wrench

- Double hammer impulse device

3/4"

CE



Free speed	5,000 rpm
Max. torque	1,695 Nm
Bolt capacity	CI 8.8 M30 ● 46 mm
Bolt capacity	CI 12.9 M27 ● 41 mm
Air inlet	3/8" GAS
Working pressure	6,2 bar
Internal hose size (Ø)	10 mm
Mean air consumption	240 l/min
Weight	4,3 kg

3/4"	kg	1	019280022
4,3			

1928DAL

reversible impact wrench

- Double hammer impulse device

3/4"

CE



Free speed	5,000 rpm
Max. torque	1,695 Nm
Bolt capacity	CI 8.8 M27 ● 41 mm
Bolt capacity	CI 12.9 M24 ● 36 mm
Air inlet	3/8" GAS
Working pressure	6,2 bar
Internal hose size (Ø)	10 mm
Mean air consumption	240 l/min
Weight	4,8 kg

3/4"	kg	1	019280023
4,8			

1928K4

assortment of one reversible impact wrench and four impact sockets, long series

- "Pin Clutch" impulse device

3/4" CE



728L 27-30-32-36 mm

Free speed	4,000 rpm
Max. torque	1,493 Nm
Bolt capacity	CI 8.8 M27 ● 41 mm
Bolt capacity	CI 12.9 M24 ● 36 mm
Air inlet	3/8" GAS BSP
Working pressure	6,2 bar
Internal hose size (Ø)	10 mm
Mean air consumption	260 l/min
Impact wrench weight	5,2 kg

3/4"	kg	1	019280104
9,3			
410x330x106 mm			

1930LH

reversible impact wrench

- Double hammer impulse device

1" CE



Free speed	6,000 rpm
Max. torque	2,441 Nm
Bolt capacity	CI 8.8 M36 ● 55 mm
Bolt capacity	CI 12.9 M30 ● 46 mm
Air inlet	1/2" GAS
Operating pressure	6,2 bar
Internal hose size (Ø)	13 mm
Mean air consumption	280 l/min
Weight	7,1 kg

1"	kg	1	019300030
7,1			

1930LA

reversible impact wrench

- Double hammer impulse device

1" CE



Free speed	4,000 rpm
Max. torque	2,445 Nm
Bolt capacity	CI 8.8 M36 ● 55 mm
Bolt capacity	CI 12.9 M30 ● 46 mm
Air inlet	1/2" GAS
Working pressure	6,2 bar
Internal hose size (Ø)	13 mm
Mean air consumption	460 l/min
Weight	10,6 kg

1"	kg	1	019300037
10,6			

1930CD

reversible impact wrench, made from composite material

- Double hammer impulse device

1" CE



Free speed	4,000 rpm
Max. torque	2,445 Nm
Bolt capacity	CI 8.8 M36 ● 55 mm
Bolt capacity	CI 12.9 M30 ● 46 mm
Air inlet	1/2" GAS
Working pressure	6,2 bar
Internal hose size (Ø)	13 mm
Mean air consumption	320 l/min
Weight	7,1 kg

1"	kg	1	019300022
7,1			

1930PA

reversible impact wrench

- Double hammer impulse device

1" CE



Free speed	3,500 rpm
Max. torque	2,445 Nm
Bolt capacity	CI 8.8 M36 ● 55 mm
Bolt capacity	CI 12.9 M30 ● 46 mm
Air inlet	1/2" GAS
Operating pressure	6,2 bar
Internal hose size (Ø)	13 mm
Mean air consumption	350 l/min
Weight	9,6 kg

1"	kg	1	019300032
9,6			

1930A

reversible impact wrench

- Double hammer impulse device

1" CE



Free speed	4,000 rpm
Max. torque	2,445 Nm
Bolt capacity	CI 8.8 M36 ● 55 mm
Bolt capacity	CI 12.9 M30 ● 46 mm
Air inlet	1/2" GAS
Working pressure	6,2 bar
Internal hose size (Ø)	13 mm
Mean air consumption	460 l/min
Weight	9,5 kg

1"	kg	1	019300036
9,5			

1930HLA

reversible impact wrench

- Double hammer impulse device



Free speed	3,000 rpm
Max. torque	3.661 Nm
Bolt capacity	CI 8.8 M42 ● 65 mm
Bolt capacity	CI 12.9 M33 ● 50 mm
Air inlet	1/2" GAS
Working pressure	6,2 bar
Internal hose size (Ø)	13 mm
Mean air consumption	460 l/min
Weight	16,4 kg

■	kg	1	019300040
1	16,4		

1931CD6

reversible drill,
made from composite material



Free speed	2,600 rpm
Chuck capacity	1÷6 mm
Power	0,23 kW
Spindle thread	3/8" - 24UNF
Air inlet	1/4" GAS
Working pressure	6,2 bar
Internal hose size (Ø)	8 mm
Mean air consumption	130 l/min
Weight	0,6 kg

■	kg	1	019310006
0,6			

1931CD13

reversible drill,
made from composite material



Free speed	800 rpm
Chuck capacity	1,0÷13 mm
Power	0,38 kW
Spindle thread	1/2" - 20UNC
Air inlet	1/4" GAS
Working pressure	6,2 bar
Internal hose size (Ø)	10 mm
Mean air consumption	170 l/min
Weight	1,3 kg

■	kg	1	019310013
1,3			

1930ZL

reversible impact wrench

- Double hammer impulse device



Free speed	3,000 rpm
Max. torque	4.068 Nm
Bolt capacity	CI 8.8 M42 ● 65 mm
Bolt capacity	CI 12.9 M36 ● 55 mm
Air inlet	1/2" GAS
Working pressure	6,2 bar
Internal hose size (Ø)	13 mm
Mean air consumption	480 l/min
Weight	15 kg

■	kg	1	019300070
1 1/2	15		

1931CD10

reversible drill,
made from composite material



Free speed	1,800 rpm
Chuck capacity	1÷10 mm
Power	0,38 kW
Spindle thread	3/8" - 24UNF
Air inlet	1/4" GAS
Working pressure	6,2 bar
Internal hose size (Ø)	10 mm
Mean air consumption	170 l/min
Weight	1 kg

■	kg	1	019310010
1,0			

1931AN10

reversible angle drill



Free speed	1,400 rpm
Chuck capacity	1÷10 mm
Power	0,38 kW
Spindle thread	3/8" - 24UNF
Air inlet	1/4" GAS
Working pressure	6,2 bar
Internal hose size (Ø)	10 mm
Mean air consumption	150 l/min
Weight	1,1 kg

■	kg	1	019310030
1,1			

1932B10

reversible drill



Free speed	1,800 rpm
Chuck capacity	1÷10 mm
Power	0,44 kW
Spindle thread	3/8" - 24UNF
Air inlet	1/4" GAS
Working pressure	6,2 bar
Internal hose size (Ø)	10 mm
Mean air consumption	160 l/min
Weight	1,2 kg

kg 1,2

1 019320040

1932RS13

reversible drill



Free speed	750 rpm
Chuck capacity	1,5÷13 mm
Power	0,55 kW
Spindle thread	3/8" - 24UNF
Air inlet	1/4" GAS
Working pressure	6,2 bar
Internal hose size (Ø)	10 mm
Mean air consumption	160 l/min
Weight	1,4 kg

kg 1,4

1 019320043

1932B13

reversible drill



Free speed	400 rpm
Chuck capacity	1,5÷13 mm
Power	0,34 kW
Spindle thread	1/2" - 20UNC
Air inlet	1/4" GAS
Operating pressure	6,2 bar
Internal hose size (Ø)	10 mm
Mean air consumption	180 l/min
Peso	1,6 kg

kg 1,6

1 019320004

1933IH

high-power die grinder

• Collect chuck, Ø 3 mm and 6 mm



Free speed	20,000 rpm
Chuck capacity	3 - 6 mm
Power	0,75 kW
Air inlet	1/4" GAS
Working pressure	6,2 bar
Internal hose size (Ø)	10 mm
Mean air consumption	370 l/min
Weight	800 g

g 800

1 019330006

1933ILH

high-power long spindle die grinder

• Collect chuck, Ø 3 mm and 6 mm

CE



Free speed	20,000 rpm
Chuck capacity	3 - 6 mm
Power	0,75 kW
Air inlet	1/4" GAS
Working pressure	6,2 bar
Internal hose size (Ø)	10 mm
Mean air consumption	370 l/min
Weight	1,2 kg

kg 1,2

1 019330011

1933AN90-H

high-power angle grinder

• Collect chuck, Ø 3 mm and 6 mm

CE



Free speed	15,000 rpm
Chuck capacity	3 - 6 mm
Power	0,75 kW
Air inlet	1/4" GAS
Working pressure	6,2 bar
Internal hose size (Ø)	10 mm
Mean air consumption	370 l/min
Weight	1,1 kg

kg 1,1

1 019330021

1933

die grinder

• Collect chuck, Ø 3 mm and 6 mm

CE



Free speed	25,000 rpm
Chuck capacity	3 - 6 mm
Power	0,20 kW
Air inlet	1/4" GAS
Working pressure	6,2 bar
Internal hose size (Ø)	10 mm
Mean air consumption	230 l/min
Weight	380 g

g 380

1 019330001

Beta
Quality Tools

1933I

die grinder

- Collect chuck, Ø 3 mm and 6 mm

CE



Free speed	20,000 rpm
Chuck capacity	3 - 6 mm
Power	0,38 kW
Air inlet	1/4" GAS
Working pressure	6,2 bar
Internal hose size (Ø)	10 mm
Mean air consumption	260 l/min
Weight	670 g

g 670 1 019330005

1933L

long spindle die grinder

- Collect chuck, Ø 3 mm and 6 mm

CE



Free speed	25,000 rpm
Chuck capacity	3 - 6 mm
Power	0,20 kW
Air inlet	1/4" GAS
Working pressure	6,2 bar
Internal hose size (Ø)	10 mm
Mean air consumption	270 l/min
Weight	670 g

g 670 1 019330015

1933IL

long spindle die grinder

- Collect chuck, Ø 3 mm and 6 mm

CE



Free speed	20,000 rpm
Chuck capacity	3 - 6 mm
Power	0,38 kW
Air inlet	1/4" GAS
Working pressure	6,2 bar
Internal hose size (Ø)	10 mm
Mean air consumption	113 l/min
Weight	1,4 kg

kg 1,4 1 019330010

1933AN90

angle grinder

- Collect chuck, Ø 3 mm and 6 mm

CE



Free speed	20,000 rpm
Chuck capacity	3 - 6 mm
Power	0,20 kW
Air inlet	1/4" GAS
Working pressure	6,2 bar
Internal hose size (Ø)	10 mm
Mean air consumption	230 l/min
Weight	510 g

g 510 1 019330020

1934BV

low-speed tyre buffer

- Collect chuck, Ø 3 mm and 6 mm

CE



Free speed	3,700 rpm
Chuck capacity	3 - 6 mm
Power	0,37 kW
Air inlet	1/4" GAS
Operating pressure	6,2 bar
Internal hose size (Ø)	10 mm
Mean air consumption	113 l/min
Weight	0.84 kg

g 840 1 019340000



1934MAV

micro die grinder

CE



Free speed	56,000 rpm
Chuck capacity	3 mm
Power	0,04 kW
Air inlet	1/4" GAS BSPT
Operating pressure	6,2 bar
Internal hose size (Ø)	4,5 mm
Mean air consumption	115 l/min
Weight	0.2 kg

g 205 1 019340010

1934MAV70

high-speed micro die grinder

CE



Free speed	70,000 rpm
Chuck capacity	3 mm
Power	0,08 kW
Air inlet	1/4" GAS BSPT
Operating pressure	6,2 bar
Internal hose size (Ø)	4,5 mm
Mean air consumption	115 l/min
Weight	0.21 kg

g 210 1 019340030

1935F

reversible air screwdriver



Free speed	800 rpm
Torque range	4-16 Nm
Screw capacity	6-9 M
Bit holder	● 1/4"
Air inlet	1/4" GAS
Working pressure	6,2 bar
Internal hose size (Ø)	10 mm
Mean air consumption	150 l/min
Weight	1,3 kg



kg

1,3



1 019350045

1936/4A

angle grinder



Free speed	11,000 rpm
Grinding disc size	115 mm
Power	0,66 kW
Spindle thread	M14
Air inlet	1/4" GAS
Operating pressure	6,2 bar
Internal hose size (Ø)	10 mm
Mean air consumption	390 l/min
Weight	1,77 kg



kg

1,8



1 019360024

1936/5A

angle grinder



Free speed	10,000 rpm
Grinding disc size	125 mm
Power	0,66 kW
Spindle thread	M14
Air inlet	1/4" GAS
Working pressure	6,2 bar
Ø internal hose size	10 mm
Mean air consumption	390 l/min
Weight	1,9 kg



kg

1,9



1 019360025

1936/7A

angle grinder



Free speed	7600 giri/min
Grinding disc size	180 mm
Power	1,3 kW
Spindle thread	M14
Air inlet	3/8" GAS
Working pressure	6,2 bar
Ø internal hose size	13 mm
Mean air consumption	906 l/min
Weight	2,7 kg



kg

2,7



1 019360027

1937 2,5

roto-orbital palm sander, lubrication free, made from composite material

• Orbit diameter: 2.5 mm



Free speed	12,000 rpm
Power	0.18 kW
Pad size	150 mm
Orbit diameter	2.5 mm
Spindle thread	5/16"-24
Air inlet	1/4" GAS
Operating pressure	6.2 bar
Internal hose size (Ø)	10 mm
Mean air consumption	170 l/min
Weight	0.86 kg



kg

0,86



1 019370000

1937

Roto-orbital palm sander, lubrication free, made from composite material

• Orbit diameter: 5 mm



Free speed	12,000 rpm
Power	0.18 kW
Pad size	150 mm
Orbit diameter	5 mm
Spindle thread	5/16"-24
Air inlet	1/4" GAS
Operating pressure	6.2 bar
Internal hose size (Ø)	10 mm
Mean air consumption	170 l/min
Weight	0,86 kg



kg

0,86



1 019370001

1937R/P

6-hole pad, Ø 150 mm, for item 1937



1937R/P



1 019370002

1937KC

mini orbital sander

- Orbit diameter 4 mm
- 2 sanding pads (Ø 50 mm and Ø 75 mm)
- 10 abrasive paper discs (Ø 50 mm), grain 400, 600, 800
- 10 abrasive paper discs (Ø 75 mm), grain 400, 600, 800

CE



Free speed	15000
Power	0.25
Pad size	50 - 75
Spindle thread	M6 x 1.0
Air inlet	1/4" GAS BSPT
Operating pressure	6.2 bar
Internal hose size (Ø)	10
Mean air consumption	79
Polisher weight	0.64
Kit weight	1.4

kg	1	019370171
1,4		

1937C...

Abrasive paper discs for item 1937KC

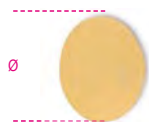

Ø mm	P	
50	400	1 019370175
50	600	1 019370176
50	800	1 019370177
75	400	1 019370178
75	600	1 019370179
75	800	1 019370180



Beta

Beta

Quality Tools

1937KL

mini polisher

- Sanding pad (Ø 75 mm)
- 2 polishing sponges (Ø 90 mm) - 1937/KL-DSB, 1937/KL-DSG
- Lambswool pad (Ø 90 mm) - 1937/KL-DLA

CE



Free speed	3,200 rpm
Power	0.25 kW
Pad size	75 mm
Spindle thread	M6
Air inlet	1/4" GAS BSPT
Operating pressure	6.2 bar
Internal hose size (Ø)	10 mm
Mean air consumption	91 l/min
Polisher weight	0.75 kg
Kit weight	1.8 kg

kg	1	019370161
1,8		

1937KL-D

accessories for item 1937KL



	Ø mm	
1937KL-DLA	90	1 019370164
1937KL-DSB	90	1 019370165
1937KL-DSG	90	1 019370166

1937K...

Pads for items 1937KC and 1937KL



	Ø mm	1937KC	1937KL	
1937KC-RP	50	•		1 019370173
1937KL-RP	75	•	•	1 019370163

1937RT

orbital palm sander, made from composite material, with suction system

- Orbit diameter 5 mm
- Rectangular pad (100x110 mm)
- Delta pad (125x95 mm)

CE



Free speed	10,000 rpm
Orbit diameter	5 mm
Air inlet	1/4" GAS
Operating pressure	6.2 bar
Internal hose size (Ø)	10 mm
Mean air consumption	180 l/min
Weight	0.9 kg

kg	1	019370021
0,9		

1937RT/R

rectangular pad for item 1937RT



	L mm	L1 mm	
1937RT/R	110	100	1 019370022

1937RT/T

Delta pad for item 1937RT



	L mm	L1 mm	
1937RT/T	125	95	1 019370023



Beta

1937M

multi-use sander
with 16 accessories

CE



Ø 1/4" GAS BSPT



Free speed	3,500 rpm
Power	0,34 kW
Air inlet	1/4" GAS
Working pressure	6,2 bar
Internal hose size (Ø)	10 mm
Mean air consumption	113 l/min
Sander weight	1,5 kg
Kit weight	4,5 kg

	kg		1	019370011
	458x495x116 mm			

1937M-01÷11

accessories for item 1937M



L mm	1937M-		
30	1937M-01	1	019370101
30	1937M-02	1	019370102
11	1937M-03	1	019370103
23	1937M-04	1	019370104
11	1937M-05	1	019370105
23	1937M-06	1	019370106
16	* 1937M-07	1	019370107
13	1937M-08	07	019370108
26	1937M-09	07	019370109
11	1937M-10	03, 05	019370110
23	1937M-11	01, 02, 04, 06	019370111

1937N10

pneumatic belt sander

CE



Free speed	20,000 rpm
Power	0,37 kW
Belt size	10x330 mm
Air inlet	1/4" GAS
Working pressure	6,2 bar
Internal hose size (Ø)	10 mm
Mean air consumption	374 l/min
Weight	0,9 kg

	kg		1	019370041
--	-----------	--	----------	------------------

1937N10-GR

sand belts for item 1937N10



	P		
1937N10-GR60	60	1	019370146
1937N10-GR80	80	1	019370148
1937N10-GR100	100	1	019370150
1937N10-GR120	120	1	019370152

1937N20

pneumatic belt sander

CE



Free speed	16,000 rpm
Power	0,45 kW
Belt size	20x520 mm
Air inlet	1/4" GAS
Working pressure	6,2 bar
Internal hose size (Ø)	10 mm
Mean air consumption	400 l/min
Weight	1,6 kg

	kg		1	019370051
--	-----------	--	----------	------------------

1937N20-GR

sand belts for item 1937N20



	P		
1937N20-GR60	60	1	019370156
1937N20-GR80	80	1	019370158
1937N20-GR100	100	1	019370160
1937N20-GR120	120	1	019370162

1938

Windscreen remover

• Supplied with 1 57 mm straight blade

CE



Oscillations/minute	20,000
Air inlet	1/4" GAS
Operating pressure	6,2 bar
Internal hose size (Ø)	6,5 mm
Mean air consumption	200 l/min
Weight	1,0 kg

	kg		1	019380021
--	-----------	--	----------	------------------

1938R/L

blades for windscreen removers

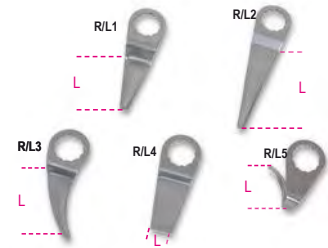

	L mm		
1938R/L1	57	1	019380041
1938R/L2	90	1	019380042
1938R/L3	50	1	019380043
1938R/L4	16	1	019380044
1938R/L5	36	1	019380045

1938R/S5

set of 5 blades for item 1938

	kg		1	019380055
--	-----------	--	----------	------------------

1940

air hammer

- Supplied with a nonreturn spring and a bayonet retainer for hexagon chisels



Strokes per minutes	3,500
Chisel inlet	○ 11 mm
Piston size	19 mm
Piston stroke	67 mm
Air inlet	1/4" GAS
Working pressure	6.2 bar
Internal hose size (Ø)	8 mm
Mean air consumption	240 l/min
Weight	1.9 kg

kg 1,9 1 019400001

1940E10

air hammer

- Compatible with chisels with 10-mm hexagon drive
- Supplied with a nonreturn spring and a bayonet retainer



Strokes per minute	2,900
Inlet size	○ 10 mm
Piston size	19 mm
Piston stroke	67 mm
Chisel inlet	1/4" GAS
Working pressure	6.2 bar
Internal hose size (Ø)	10 mm
Mean air consumption	76 l/min
Weight	1.7 kg

kg 1,7 1 019400010

1940MT

spare retainer spring for item 1940



1940MT 5 019400110

1940E10/MT

spare retainer spring for item 1940E10



1940E10/MT 5 019400112

1940S...

chisels for air hammers

item 1940



1940SN	5 019400020
1940ST	5 019400021
1940SD	5 019400022
1940SPS	5 019400023
1940SDT	5 019400024

1940E10/S...

chisels for air hammers 1940E10



1940E10/SN	5 019400040
1940E10/ST	5 019400041
1940E10/SD	5 019400042
1940E10/SPS	5 019400043
1940E10/SDT	5 019400044

1940/S5

set of 5 chisels for air hammers

item 1940



1940/S5 1 019400030

1940E10/S5

set of 5 chisels for air hammers 1940E10



1940E10/S5 1 019400050



Beta

1942A

air saw

CE



Strokes per minute	10.000
Stroke length	10 mm
Air inlet	1/4" GAS BSP
Operating pressure	6,2 bar
Internal hose size (Ø)	8 mm
Mean air consumption	75 l/min
Weight	550 g

550 g 1 019420000

1942LR

Bimetal blades
for air saw 1942A



1942LR 5 019420032

1944A

axial needle scaler

CE



Strokes per minute	3.800
Stroke length	33 mm
N°. of needles	19
Needle size (Ø)	3 mm
Air inlet	1/4" GAS
Working pressure	6.2 bar
Internal hose size (Ø)	10 mm
Mean air consumption	85 l/min
Weight	2.8 kg

2,8 kg 1 019440011

1944N

needle scaler

CE



Strokes per minute	3800
Stroke length	33 mm
N°. of needles	19
Needle size (Ø)	3 mm
Air inlet	1/4" GAS
Working pressure	6.2 bar
Internal hose size (Ø)	8 mm
Mean air consumption	85 l/min
Weight	2.7 kg

2,7 kg 1 019440002

1944AR

set of needles
for needle scalars 1944N and 1944A



	Ø mm	n.	
1944AR 2	2	29	1 019440015
1944AR 3	3	19	1 019440005

1944PA

needle plates for items 1944N and 1944A



	Ø mm	N.	
1944PA 2	2	29	1 019440016
1944PA 3	3	19	1 019440006



1945S

stapler

• Uses staples type 80, section 0.95 x 0.65 mm (21-Gauge), length: 4 - 16 mm; width: 12.8 mm

CE



Magazine capacity	157 pcs
Air inlet	1/4" GAS
Working pressure	4,2 - 7 bar
Internal hose size (Ø)	8 mm
Air consumption (7 bar)	0.34 l/cycle
Weight	0.87 kg

0,9 kg 1 019450000

1945S/G...

staples type 80, section 0.95x0.65 mm
(21-Gauge), width 12.8 mm, for item 1945S



	L mm	
• 1945S/G4	4	1 019450004
1945S/G6	6	1 019450006
1945S/G8	8	1 019450008
1945S/G10	10	1 019450010
1945S/G12	12	1 019450012
1945S/G14	14	1 019450014
1945S/G16	16	1 019450016

1945C

stapler, nailer, combo tool

• Uses staples type 90, section 1.25 x 1.0 mm (18-Gauge), length: 16 - 40 mm; width: 5.8 mm
• Uses round-headed nails type B12, section 1.25 x 1.0 mm (18-Gauge), 1.9-mm head

CE



Magazine capacity	100 pcs
Air inlet	1/4" GAS
Working pressure	5 - 8 bar
Internal hose size (Ø)	8 mm
Air consumption (7 bar)	1.12 l/cycle
Weight	1.16 kg

1,16 kg 1 019450200

1945C/G...

staples type 90, section 1.25x1.0 mm (18-Gauge), width 5.8 mm, for item 1945C

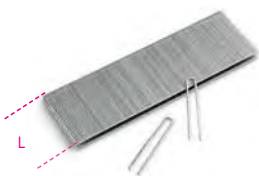

	L mm		
1945C/G16	16	1	019450216
1945C/G19	19	1	019450219
1945C/G22	22	1	019450222
1945C/G25	25	1	019450225
1945C/G28	28	1	019450228
1945C/G32	32	1	019450232
1945C/G35	35	1	019450235
1945C/G38	38	1	019450238
1945C/G40	40	1	019450240

1945C/GP...

nails type B12, section 1.25x1.0 mm (18-Gauge), 1.9 mm-head, for item 1945C

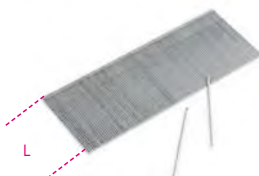

	L mm		
1945C/GP15	15	1	019450255
1945C/GP16	16	1	019450256
1945C/GP20	20	1	019450260
1945C/GP25	25	1	019450265
1945C/GP30	30	1	019450270
1945C/GP32	32	1	019450272
1945C/GP35	35	1	019450275
1945C/GP38	38	1	019450278
1945C/GP40	40	1	019450280
1945C/GP45	45	1	019450285
1945C/GP50	50	1	019450290

1945P

headless pinner

• Uses pins type B6, Ø 0.64 mm (23-Gauge), length: 12 - 35 mm



Magazine capacity	145 pcs
Air inlet	1/4" GAS
Working pressure	4 - 7 bar
Internal hose size (Ø)	8 mm
Air consumption (7 bar)	0.27 l/cycle
Weight	0.87 kg

kg	1	019450100
0,87		

1945P/S...

pins type B6, Ø 0.64 mm (23-Gauge), for item 1945P

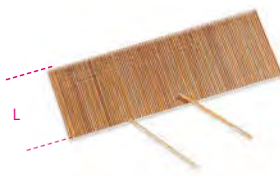

	L mm		
1945P/S12	12	1	019450112
1945P/S15	15	1	019450115
1945P/S18	18	1	019450118
1945P/S20	20	1	019450120
1945P/S21	21	1	019450121
1945P/S22	22	1	019450122
1945P/S25	25	1	019450125
1945P/S30	30	1	019450130
1945P/S35	35	1	019450135

1946T

air riveter

• supplied with interchangeable nozzles for steel, stainless steel, aluminium and copper rivets, 2.4 - 3.2 - 4.0 - 4.8 mm long



Traction power	9,000 N
Stroke length	16 mm
Maximum rivet capacity	Stainless steel Ø 4.8 mm
Air inlet	1/4" GAS
Working pressure	6,2 bar
Internal hose size (Ø)	8 mm
Air consumption	2.0 l/cycle
Weight	1.7 kg

kg	1	019460021
1,7		



1946C4,8

riveter

• Automatic suction
• Supplied assembled for use with 2.4 - 3.2 - 4.0 - 4.8 mm long steel, stainless steel, aluminium and copper rivets



Traction power	8,900 N
Stroke length	15 mm
Maximum rivet capacity	Stainless steel Ø 4.8 mm
Air inlet	1/4" GAS
Operating pressure	6,2 bar
Internal hose size (Ø)	10 mm
Air consumption	2.6 l/cycle
Weight	1.5 kg

kg	1	019460006
1,5		

1946C7,8

riveter

• Automatic suction
• Supplied assembled for use with 4.8 - 5.6 - 6.4 - 7.8 mm long steel, stainless steel, aluminium and copper rivets



Traction power	16,900 N
Stroke length	22.5 mm
Maximum rivet capacity	Stainless steel Ø 7.8 mm
Air inlet	1/4" GAS
Operating pressure	6,2 bar
Internal hose size (Ø)	10 mm
Air consumption	4.9 l/cycle
Weight	1.8 kg

kg	1	019460008
1,8		

1946C/T...

heads for structural rivets



	Ø mm		
1946C/T4,8	4,8	1	019460016
1946C/T6,4	6,4	1	019460018

1946KF

air riveter for threaded inserts

- Supplied assembled for threaded rivets made of steel, stainless steel, aluminium and copper, M4, M5, M6, M8



Traction power	14,235 N
Stroke length	7 mm
Maximum rivet capacity	Stainless steel Ø, M8
Air inlet	1/4" GAS
Operating pressure	6,2 bar
Internal hose size (Ø)	10 mm
Air consumption	2.1 l/cycle
Air riveter weight	2.1 kg
Kit weight	3.4 kg

kg 3,4 1 019460012

1946KF/M...

spare pins for item 1946KF



1946KF/M4	1	019460124
1946KF/M5	1	019460125
1946KF/M6	1	019460126
1946KF/M8	1	019460128

1947

bonding gun

- Pneumatic gun for medium-density silicone, adhesives and bonds
- Supports standard cartridges (210 x 50 mm), hard and soft



Tube size	210x50 mm
Cartridge capacity	350 ml
Air inlet	1/4" GAS
Working pressure	4,8 bar
Internal hose size (Ø)	10 mm
Mean air consumption	120 l/min
Weight	1,1 kg

kg 1,1 1 019470001

1947H

bonding gun

- Pneumatic gun for extruding silicone and bonds in standard plastic or aluminium
- Supports standard cartridges (215/218 x 50/51 mm), hard and soft
- Built-in pressure reducing valve



Tube size	210x50 mm
Cartridge capacity	300/310 ml
Air inlet	1/4" GAS
Working pressure	4 ÷ 8 bar
Internal hose size (Ø)	2.5 mm
Mean air consumption	120 l/min
Weight	750 g

g 750 1 019470011

1947G

grease gun

- Die-cast aluminium head
- Ergonomic grip for ease of access to tough greasing points
- Corrosion-resistant brass valve
- Takes 400 g cartridges or bulk grease up to 500 cc
- Tube size: 54 (interior) x 260 mm
- Air inlet: 1/4" GAS
- Operating pressure: 4+10 bar
- Weight: 1.9 kg



1 019470051



1947M

gun for single-component sealants

- Can be used with 310 ml plastic cartridges
- Supplied with extrusion nozzle kit



Tube dimensions	210x50 mm
Cartridge capacity	310 ml
Air inlet	1/4" GAS
Working pressure	3 ÷ 5 bar
Nozzle Ø	1.6 - 2.5 mm
Mean air consumption	250 l/min
Weight	1.2 kg

kg 1,2 1 019470021

1947M -...

spare nozzles for item 1947M



1947M-ST	10	019470025
1947M-T	10	019470026
1947M-P	10	019470027

1948

engraving pen

- Allows such materials as steel, stainless steel, aluminium, glass, stone and ceramic to be marked



Strokes per minute	3,500 ÷ 3,800
Maximum hardness	60 HRC
Air inlet	1/4" GAS
Working pressure	6,2 bar
Mean air consumption	50 l/min
Weight	150 g

g 150 1 019480001

1948PR

spare tungsten carbide bit
for item 1948

- Maximum hardness: 60 HRC



1948PR 1 019480005

1949U5

progressive blow gun with 5 nozzles

- Hard-wearing, shockproof composite material body
- 3 steel nozzles, 100/160/320 mm, scratchproof, protective rubber tips
- 1 "Turbo" nozzle made of fibreglass-reinforced nylon with safety tip
- 1 revolving nozzle, 100 mm, made of fibreglass-reinforced nylon
- With quick fixing system



Ø 1/4" GAS BSPT

Threaded brass insert	1/4" GAS
Working pressure	10 bar
Maximum working pressure	15 bar
Mean air consumption	280 l/min
Working temperature	-10°C ÷ 80°C
Weight	93 g

g 93 1 019490030

1949U5/A

steel nozzle, 100 mm, with scratchproof,
protective rubber tip, for item 1949U5 - 1949P



1949U5/A 1 019490131

1949U5/B

steel nozzle, 160 mm, with scratchproof,
protective rubber tip, for item 1949U5 - 1949P



1949U5/B 1 019490132

1949U5/C

steel nozzle, 320 mm, with scratchproof,
protective rubber tip, for item 1949U5 - 1949P



1949U5/C 1 019490133

1949U5/D

revolving nozzle, 100 mm, made of fibreglass
reinforced nylon, for item 1949U5 - 1949P



1949U5/D 1 019490134

1949U5/E

"Turbo" nozzle made of fibreglass-reinforced
nylon, with safety tip



1949U5/E 1 019490135

1949U5/F

flat, fan-shaped nozzle, made of fibreglass-
reinforced nylon, for items 1949U5 and 1949P



1949U5/F 1 019490136

1949U5/G

OSHA nozzle, made of fibreglass-reinforced
nylon, for items 1949U5 and 1949P



1949U5/G 1 019490137

1949BC

progressive blow gun with rubber nozzle

- Hard-wearing, shockproof composite material body
- Replaceable scratchproof rubber nozzle



Aluminium threaded insert	1/4" GAS
Operating pressure	6-8 bar
Maximum operating pressure	15 bar
Mean air consumption	87 l/min
Operating temperature	-20°C ÷ 70°C
Weight	120 g

g 120 1 019490022

1949BC/RU

5 rubber nozzles for item 1949BC



1949BC/RU 1 019490122

1949P

progressive mini blow gun

- Hard-wearing, shockproof composite material body
- Quick nozzle fixing system
- Airflow can be adjusted through ring nut rotation



Ø 1/4" GAS BSPT

Brass threaded insert	1/4" GAS
Working pressure	6÷8 bar
Maximum operating pressure	15 bar
Mean air consumption	280 l/min
Operating temperature	-10 °C ÷ 85 E97°C
Weight	70 g

g 70 1 019490031



1949T

telescopic progressive blow gun

- Hard-wearing, shockproof composite material body
- Telescopic steel swivel tube: 165 mm ÷ 300 mm



Aluminium threaded insert
Operating pressure 6÷8 bar
Maximum operating pressure 15 bar
Mean air consumption 144 l/min
Operating temperature -20°C ÷ 70°C
Weight 190 g

190 g 1 019490040

1949F

progressive blow gun

- Made from hard-wearing, shockproof, scratchproof, thermally insulated composite plastic material
- The special valve and the lever allow the circuit to be progressively opened, thus optimizing air flow



Brass threaded insert
Operating pressure 6-8 bar
Maximum operating pressure 10 bar
Operating temperature -15°C ÷ 70°C
Weight 130 g

130 g 5 019490027

1949G

progressive blow gun
with air regulator

- Made from hard-wearing, shockproof, scratchproof, thermally insulated composite plastic material
- The special valve and the lever allow the circuit to be progressively opened, thus optimizing air flow



Brass threaded insert
Operating pressure 6-8 bar
Maximum operating pressure 10 bar
Operating temperature -15 °C ÷ 70 °C
Weight 140 g

140 g 5 019490035

1949DGT

digital tyre inflator

- Operating pressure: 0÷14 bar (0÷200 psi)
- 4 units of measurement: psi/bar/kgcm2/kpa
- Backlit LCD display
- Reset feature
- Self-power off after 3 min.
- Pressure release button
- Resolution: 0.05 bar
- ABS housing, protective rubber shell on gauge, shockproof, nonslip handle grip
- Power supply: 2 AAA size 1.5V batteries
- Compatible with coupling 19161 1/4"



1949DGT bar 0-14 g 500 1 019490020

1949GPE

tyre inflator

- Operating pressure: 0÷11 bars (10÷160 psi)
- Pressure release feature
- Pressure measurement feature
- Gauge coated with shockproof rubber
- 360 degree hose rotation



1949GPE bar 0÷11 g 640 1 019490008

1949GPN

tyre inflator,
ABS housing

- CE certified pressure gauge with scale 0.7÷12 bars (graduation: 1/10 bars)
- Two servo-controlled buttons allow accurate, quick tyre inflating (+) and deflating (-)
- Supplied with a calibration certificate
- Fitted with a shockproof, protective shell and an eyelet
- Fitted with a 1/4" GAS threaded coupler
- Swivel air inlet for rubber hose, Ø 7 mm



1949GPN bar 0,7÷12 g 810 1 019490011

1949M

tyre pressure tester



1949M bar 0÷4 psi 5÷60 g 280 1 019490400

Beta

Beta
Quality Tools



1951 cleaning gun

- For cleaning car upholstery, carpeting, seats and boots



Free speed	
Tank capacity	1 L
Air inlet	1/4" GAS
Working pressure	6,2 bar
Internal hose size (Ø)	8 mm
Mean air consumption	110 l/min
Weight	650 g

g	1	019510051
650		

1951A suction cleaning gun

- For cleaning car upholstery, carpeting, seats and boots
- For use with suitable detergents
- 1L tank
- Fitted with a tap for dispensing liquid from tank
- Complete with corrugated tube, 1.8 m long



Tank capacity	1 l
Air inlet	1/4" GAS
Operating pressure	6.2 bar
Internal hose size (Ø)	8 mm
Mean air consumption	120 l/min
Weight	800 g

g	1	019510101
800		

1952

professional paint spray gun

- Die-cast aluminium body plated with black chemical nickel
- Nylon cup with drip-catching device, 3/8M BSP thread
- Body thread: 1/4" BSP cylindrical gas thread
- Pressure and airflow regulator
- Jet regulator from round to fan spray pattern
- Paint quantity regulator
- Supplied with service spanner for maintenance operations

CE



	Ø mm		
1952 1,2	1,2	1	019520012
1952 1,5	1,5	1	019520015
1952 1,8	1,8	1	019520018
1952 2,0	2,0	1	019520020

1901BM/8

automatic hose reel
shock-proof plastic body
for compressed air or cold water

- Max. operating pressure: 12 bar

CE

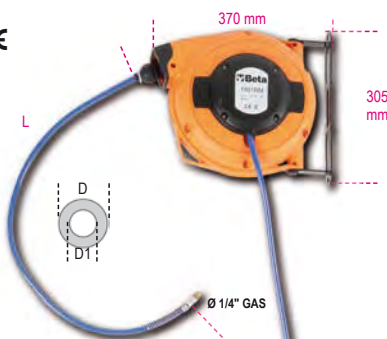

D1xD	L	Ø GAS	
mm	m	BSP	
8x12	9+1	1/4"	1 019010111

1901T/10

automatic hose reel,
shock-proof plastic body,
for compressed air or cold water

- Max. operating pressure: 15 bar

CE



D1xD	L	Ø GAS	
mm	m	BSP	
10x14	15+1	3/8"	1 019010210

1910

automatic hose reel,
aluminium body,
for compressed air or cold water

- Max. operating pressure: 15 bar

CE



D1xD	L	A	B	Ø GAS
mm	m	mm	mm	mm
8x12	9+1	375	130	1/4"

1910/8	1	019100008
--------	---	-----------

D1xD	L	A	B	Ø GAS
mm	m	mm	mm	mm
10x14	15+1	490	160	3/8"

1910/10	1	019100010
---------	---	-----------

1914

polyurethane recoiled hoses, 98 Shore,
extendable

- Maximum operating pressure: 12 bar

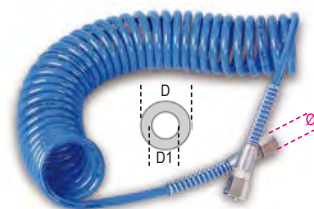

L	D1xD	Ø GAS	
m	mm	BSP	
4	5x8	1/4"	1 019140054
6	5x8	1/4"	1 019140056
10	5x8	1/4"	1 019140060

1915B

polyurethane recoil hoses, 95 Shore,
extendable up to 9 m

- Maximum operating pressure: 10 bar

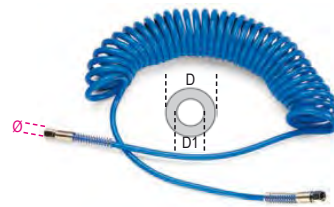

D1xD	Ø GAS	
mm	BSP	
6,5x10	1/4"	1 019150011
8x12	1/4"	1 019150012
11x16	3/8"	1 019150013



1915C

polyurethane recoil hoses, 95 Shore, extendable up to 12 m

• Maximum operating pressure: 10 bar

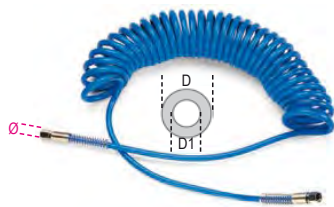

D1xD	Ø GAS		
mm	BSP		
6,5x10	1/4"	1	019150014
8x12	1/4"	1	019150015
11x16	3/8"	1	019150016

1915C/L

polyurethane recoil hoses, 95 Shore, extendable up to 15 m

• Maximum operating pressure: 10 bar



D1xD	Ø GAS		
mm	BSP		
8x12	1/4"	1	019150115
11x16	3/8"	1	019150116

1915D

braided polyurethane hose, 95 Shore, 9 metres long

• Maximum operating pressure: 15 bar



D1xD	Ø GAS		
mm	BSP		
8x12	1/4"	1	019150017
11x16	3/8"	1	019150018

1915E

braided polyurethane hose, 95 Shore, 12 metres long

• Maximum operating pressure: 15 bar



D1xD	Ø GAS		
mm	BSP		
8x12	1/4"	1	019150019
11x16	3/8"	1	019150020

1915E/XL

braided polyurethane coils, 95 Shore, 50 m long

• Maximum operating pressure: 15 bar



D1xD	Ø GAS		
mm	BSP		
8x12	1/4"	1	019150519
11x16	3/8"	1	019150520

1916I

quick couplings Italian profile male threaded, cylindrical (BSP)



Ø GAS			
BSP			
1/4"	5	019160001	
3/8"	5	019160002	

1916G

quick couplings European profile male threaded, tapered (BSPT)



Ø GAS			
BSPT			
1/4"	5	019160005	
3/8"	5	019160010	
1/2"	5	019160012	

1916GF

quick couplings, Italian profile, female threaded, cylindrical (BSP)



Ø GAS			
BSP			
1/4"	5	019160055	
3/8"	5	019160060	

1916GFE

quick couplings, European profile, female threaded, tapered (BSPT)



Ø GAS			
BSPT			
1/4"	5	019160075	
3/8"	5	019160082	
1/2"	5	019160084	

1916JM

quick couplings, Asian profile, male threaded, tapered (BSPT)



Ø GAS			
BSPT			
1/4"	1	019160406	
3/8"	1	019160410	

1916JF

quick couplings, Asian profile, female threaded, cylindrical (BSP)



Ø GAS			
BSPT			
1/4"	1	019160456	
3/8"	1	019160460	

1916P

quick couplings, Italian profile, with sleeve for rubber hose



D1xD			
mm			
6x14	5	019160256	
8x17	5	019160258	
10x19	5	019160260	

1916S

quick couplings, Italian profile, with coil springs

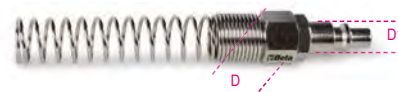

D1xD			
mm			
6x8	5	019160306	
8x10	5	019160308	
10x12	5	019160310	

1917M

universal ball quick couplers, shockproof rubber, male threaded, cylindrical (BSP)

• Designed for couplings 1916I and 1916G



Ø GAS			
BSP			
1/4"	5	019170001	
3/8"	5	019170003	
1/2"	5	019170004	

1917F

universal ball quick couplers,
shockproof rubber,
female threaded, cylindrical (BSP)

- Matches couplings 1916I and 1916G



Ø GAS BSP		
1/4"	5	019170005
3/8"	5	019170010
1/2"	5	019170014

1917JM

ball quick couplers,
Asian profile,
male threaded, cylindrical (BSP)



Ø GAS BSP		
1/4"	1	019170406
3/8"	1	019170410
1/2"	1	019170412

1917JF

ball quick couplers, Asian profile,
female threaded, cylindrical (BSP)



Ø GAS BSP		
1/4"	1	019170456
3/8"	1	019170460

1917RG

rotary universal coupler

- Made of aluminium, female threaded, cylindrical (BSP)
- male threaded, cylindrical (BSP)
- Matches all couplings with Italian and European profiles
- Rotates freely, even without connected area



Ø GAS BSP		
1/4"	1	019170252

1917SP

universal ball quick couplers,
with sleeve for rubber hose



D1xD mm		
6x14	5	019170206
8x17	5	019170208
10x19	5	019170210

1917ST

universal ball quick couplers,
with coil springs

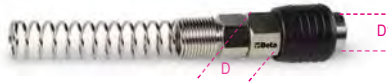

D1xD mm		
6x8	5	019170306
8x10	5	019170308
10x12	5	019170310

1918

hose tail fitting, male threaded



D1 mm	Ø GAS BSP		
6	1/8"	3	019180106
8	1/8"	3	019180108
6	1/4"	3	019180116
8	1/4"	3	019180118
10	1/4"	3	019180120
10	3/8"	3	019180130
12	3/8"	3	019180132
10	1/2"	3	019180140
12	1/2"	3	019180142

1918N

connecting nipples
with tapered threads (BSPT)



Ø mm	Ø1 mm		
1/4"	1/4"	5	019180300
3/8"	3/8"	5	019180310
1/2"	1/2"	5	019180320

1918R

reducing nipples
with tapered threads (BSPT)



Ø mm	Ø1 mm		
1/4"	3/8"	5	019180200
3/8"	1/2"	5	019180210

1919FE1/4

filter-regulator-lubricator



Air in/outlet	1/4" GAS BSPT
Pressure gauge inlet	1/8" GAS BSPT
Maximum air capacity	750 l/min
Maximum pressure	9,5 bar
Operating pressure	0,5 - 8,5 bar
Operating temperature	5 - 60 °C
Filter capacity	5 micron
Cup capacity	15 cc air / 25 cc oil
Weight	700 g

g		
700	1	019190200

1919RB-FE1/4

set of spare cups for item 1919FE1/4



g		
1919RB-FE1/4	1	019190210

1919RF-FE1/4

spare filter for item 1919FE1/4



g		
1919RF-FE1/4	1	019190230

1919RM-FE1/4

spare pressure gauge
for item 1919FE1/4



g		
1919RM-FE	1	019190220

1919F1/4 filter-regulator-lubricator



Air in/outlet 1/4" GAS BSPT
Maximum air capacity 1000 l/min
Maximum pressure 9,5 bar
Operating pressure 0,5 - 8,5 bar
Operating temperature 5 - 60 °C
Filter capacity 5 microns
Cup capacity 60 cc air / 90 cc oil
Weight 1.3 kg

kg 1,3 1 019190250

1919F3/8 filter-regulator-lubricator



Air in/outlet 3/8" GAS BSPT
Maximum air capacity 1350 l/min
Maximum pressure 9,5 bar
Operating pressure 0,5 - 8,5 bar
Operating temperature 5 - 60 °C
Filter capacity 5 microns
Cup capacity 60 cc air / 90 cc oil
Weight 1.3 kg

kg 1,3 1 019190350

1919F1/2 filter-regulator-lubricator



Air in/outlet 1/2" GAS BSPT
Maximum air capacity 2500 l/min
Maximum pressure 9,5 bar
Operating pressure 0,5 - 8,5 bar
Operating temperature 5 - 60 °C
Filter capacity 5 microns
Cup capacity 60 cc air / 90 cc oil
Weight 1.3 kg

kg 1,3 1 019190450

1919RB-F set of spare cups for filters item 1919F - 1/4", 3/8" and 1/2"



1919RB-F 1 019190510

1919RF-F spare filter for filters item 1919F - 1/4", 3/8" and 1/2"



1919RF-F 1 019190530

1919RM-F spare pressure gauge for filters item 1919F - 1/4", 3/8" and 1/2"



1919RM-F 1 019190520

1919ML mini lubricators



Ø	L	Ø		
mm	mm	mm		
1/4"	63	36	1	019190030
3/8"	63	36	1	019190032

1919SC mini water separator



Ø	L	Ø		
mm	mm	mm		
1/4"	80	40	1	019190035

1919L ISO 32 lubricating oil

Density 20°C 875 Kg/m³
Viscosity 40°C 32 cSt
Flammability COC 210°C



cc 500 5 019190050



CONTAINERS AND ASSORTMENTS

			TOOL CASES & TROLLEYS						TOOL BAGS & BOXES											TOOL TROLLEYS						
		N° of pieces	2009N/BV	2028/VV	2029/VV	2032TV	2033P/VV	2036TV	C6T		C7	C8	C10	C11 CP15L		C12	C14	CP15	C18	C19L		C20	C20L	C41H	C42H	
									C4	C5				C9	C16					C17	C19					C19L
5915VU/0	Universal maintenance	35							430																	
5915VU/1	Universal maintenance	45											431	431	431			431	431							
5915VU/2	Universal maintenance	49								432								432				432	432			
5915VU/3	Universal maintenance	74								433			433	433	433						433	433	433			
5915VU/4	Universal maintenance	80																				434	434			
5915VU/5	Universal maintenance	111														435									435	435
5915VU/AS	Universal maintenance	68											436									436	436			
5980EL/A	Electronic	57		450		450	450																			
5980EL/B	Electronic	98			451		451	451																		
5980ET/A	Electrotechnical	70		446		446											446									
5980ET/B	Electrotechnical	64			447		447	447									447									
5980ID	Plumbing	35	452																							
5980MQ	Electrotechnical	46			448																					
5980U/BIKE	Bicycle and motorcycle repairs	90																					441			
5914VU/M	Universal maintenance	109																428								
5940SBK	Bicycle and motorcycle repairs	125																						465	465	
5941VU-M	Universal maintenance	64																						466		

2001/B26

fabric wallet with assortment of 26 tools



1 020010215

55 6x7 - 8x9 - 10x11 - 12x13 - 14x15 - 16x17 mm

96N/SC9 1,5 - 2 - 2,5 - 3 - 4 - 5 - 6 - 8 - 10 mm

1044F 250 mm

1128BMX 145 mm

1150 180 mm

1201E 3x75 - 4x100 - 5,5x150 mm

1202E PH1x80 - PH2x100 mm

1370 300 g

1692 2 m

1770A 9 mm

2001/BV 1 020010051

2005PA/D

tool pouch,
empty, made from nylon, with belt



2005PA/D 1 020050000

2005PA/S

tool pouch,
empty, made from nylon, with belt



2005PA/S 1 020050020

2009N/BV

leather bag for maintenance



mm
530x190x210 1 020090200

2009ID

bag with assortment of tools
for plumbing maintenance



2009ID
(2009N/BV+5980ID) 1 020091013

2028/VV

tool case, made of polypropylene

2 tool panels
Interior bottom with removable partitions
Double combination lock



mm
470x410X185 mm 1 020280010

2028E

tool case with assortments of tools for
electronic and electrotechnical maintenance



2028EL/A
(2028/VV+5980EL/A) 1 020281014
2028ET/A
(2028/VV+5980ET/A) 1 020281018

2029/VV

tool case, made of thick polypropylene,
aluminium edged

2 tool panels
Bottom with removable and adjustable partitions
Supplied with shoulder strap
2 keyed locks



mm
490x380x230 1 020290000

2029E

tool cases with assortments of tools
for electronic and electrotechnical
maintenance



2029 BG MQ
(2029/VV+5980MQ) 1 020291257
2029ET/B
(2029/VV+5980ET/B) 1 020291021
2029EL/B
(2029/VV+5980EL/B) 1 020291017

2029/RT

universal shoulder strap for bags and cases



2029/RT 1 020290900

 **Beta**
Quality Tools

 **Beta**

2032/TV

tool trolley, made from plastic

2 tool panels
Tool pocket
Interior bottom with removable partitions



mm
430x370x200 1 020320110

2032/TE

tool trolley with assortments of tools
for electronic and electrotechnical
maintenance



2032TET/A 1 020321328
(2032/TV+5980ET/A)
2032TEL/A 1 020321314
(2032/TV+5980EL/A)

2033 P/VV

wall tool case, made from aluminium, with ABS
sides

2 tool panels
Interior bottom with removable partitions
2 keyed locks



mm
500x380x200 1 020330300

2033P

tool cases with assortments of tools
for electronic and electrotechnical
maintenance



2033PET/B 1 020331227
(2033P/VV+5980ET/B)
2033PEL/A 1 020331214
(2033P/VV+5980EL/A)
2033PEL/B 1 020331215
(2033P/VV+5980EL/B)

2036/TV

tool trolley,
made of thick polypropylene,
aluminium edged

2 tool panels
Telescopic handle
Ball bearing castors



mm
490x380x260 1 020360000

2036E

trolley with assortments of tools
for electronic and electrotechnical
maintenance



2036TET/B 1 020361223
(2036/TV+5980ET/B)
2036EL/B 1 020361218
(2036/TV+5980EL/B)

2037/TV

tool trolley, made of thick polypropylene, with 4
pivoting castors

Highly shock resistant. Suitable for tool transportation in
aircraft.
2 removable tool panels.
Built-in document pocket.
4 removable pivoting castors for horizontal trolley handling.
2 tote-trays included
2 TSA approved locks with keys
Rubber-coated handle



mm
420x325x275 mm 1 020370000

2038/TV

tool trolley, made of thick polypropylene

- Highly shock resistant
- Aluminium sealing profile
- 2 TSA approved locks with keys
- 2 removable tool panels.
- Telescopic handle and big ball bearing castors
- 2 ergonomic rubber-coated handles (including 1 side handle)
- Capacious bottom
- Document pocket
- 3 tote drawers



mm
430x500x340 1 020380000



2041UC

Utility Case with assortment of 33 tools



2041UC 1 020410215

- 55 6x7 - 8x9 - 10x11 - 12x13 - 14x15 - 16x17 mm
- 96/SC9 1,5 - 2 - 2,5 - 3 - 4 - 5 - 6 - 8 - 10 mm
- 111 200 mm
- 1048V 250 mm
- 1128BMX 145 mm
- 1150 180 mm
- 1201E 2,5x50 - 3x75 - 4x100 - 5,5x100 - 6,5x150 mm
- 1202E PH0x60 - PH1x80 - PH2x100 mm
- 1370 300 g
- 1692 3m
- 1771 170 mm
- 1833S 70 Lumen / 140 mm
- 1639NS-N 25m
- 1696 200 mm

535x282x87 mm - 4,5 Kg

2051N

assortment of 55 tools
for nautical maintenance
with shockproof polypropylene case



2051N 1 020510215

- 42NEW 7 - 8 - 10 - 12 - 13 - 14 - 17 - 19 mm
- 55AS 3/8x7/16 - 1/2x9/16 - 5/8x11/16"
- 956C □1/2 - 16 - 20,8 mm
- 1048 250 mm
- 1084BM 160 mm
- 1128BMX 145 mm
- 1150BM 180 mm
- 1166BM 160 mm
- 1201E ●3x75 - 4x100 - 5,5x150 - 6,5x150 mm
- 1202E ⊕PH1x80 - PH2x100 mm
- 1390 ∅ 35 mm
- 1490/2 ∅ max 240 mm
- 96/SC9 ○1,5÷10 mm
- 1737 145 mm
- 1778X
- 1748N 3,6 x 140 mm
- 1639NS-N 25m
- 111 200 mm
- 920A ○ 10 - 12 - 13 - 14 - 17 - 19 mm
- 920AS ○ 7/16 - 1/2 - 9/16 - 11/16 - 7/8"
- 920/22 255 mm - □1/2 - ■1/2
- 920/25 □1/2 - ■1/2
- 920/42 ■1/2
- 920/55 ■1/2

585x393x92 mm - 9 kg

2055HB

"Home Bag" case with assortment of 24 tools



2055HB 1 020550215

- 55 6x7 - 8x9 - 10x11 - 12x13 mm
- 96N/SC9 1,5 - 2 - 2,5 - 3 - 4 - 5 - 6 - 8 - 10 mm
- 1128BMX 145 mm
- 1150 180 mm
- 1048V 250 mm
- 1201E 3x75 - 4x100 - 5,5x100 mm
- 1202E PH0x60 - PH1x80 - PH2x100 mm
- 1370 300 g
- 1692 3m

373x275x70 mm - 3 Kg

2060/WV

hard cavity wall tool case

Floating, waterproof/watertight
Made from thick resin
With manual pressure release valve



IP67

490x410x210 mm 1 020600101

2080/V6

organizer tool case with 6 removable tote-trays
and adjustable partitions



2080/V6 385x320x60 mm 1 020800060

2080/V6-U

removable tote-tray for organizer tool case
2080/V6



2080/V6-U 1 020800066

90x60x50 mm

2080/D10

set of 10 adjustable partitions for organizer
tool case 2080/V6



2080/D10 1 020800070



2080/V12

organizer tool case with 12 removable tote-trays



2080/V12 300x145x330 mm 1 020800000

2080/V12-...

removable tote-tray for organizer tool case 2080/V12



2080/V12-S	3	020800013
95x75x65 mm		
2080/V12-M	2	020800015
145x75x65 mm		
2080/V12-L	1	020800020
295x75x65 mm		

C4 - 2104

tool basket made of technical fabric

Removable internal tool panel
Internal and external pockets and elastic tool holder
Sturdy waterproof base with rubber feet
Supplied with shoulder strap



C4	1	021040000
2104VU/0	1	021041122
(C4+5915VU/0)		
360x330x260 mm - 2,5 kg		

C5S

tool rucksack, made of hard-wearing polyester

- Double handle on top centre of rucksack for firm, balanced hold
- Two large front pockets
- Two capacious interior pockets and 2 additional Velcro straps
- Handy roll-up interior bag, composed of 4 tool panels
- Adjustable reinforced shoulder straps
- Maximum carrying capacity: 15 kg



C5S	1	021050100
370x300x100 mm - 0,9 Kg		

C5 - 2105

tool rucksack, made of technical fabric



C5	1	021050000
2105VU/0	1	021051122
(C5+5915VU/0)		
500x400x180 mm - 2,5 Kg		



Beta

C6T - 2106

tool rucksack, made of technical fabric, with castors



C6T 1 021060010
2106T/VU0 1 021061123
 (C6T+5915VU/0)

480x370x220 mm - 4,5 kg

C7 - 2107

technical fabric tool bag

2 removable interior tool panels
 Interior PC pocket
 2 exterior front pockets
 Interior bottom made of plastic, with removable partitions



C7 1 021070000
2107VU/2 1 021071112
 (C7+5915VU/2)

2107VU/3 1 021071114
 (C7+5915VU/3)

440x370x170 mm - 3,5 kg

C8 - 2108

technical fabric tool trolley



C8 1 021080000
2108 VU/1 1 021081022
 (C8+5915VU/1)

470x370x280 mm - 4 kg

C9 - 2109

technical fabric tool bag

- Hard base
- Interior and exterior tool pockets
- Exterior pocket with zip closure for enhanced safety
- Pocket with strap closure for personal belongings
- Double bottom
- Double string for levels
- Shoulder strap for easier transport



C9 1 021090000
2109VU/1 1 021091022
 (C9+5915VU/1)

2109VU/3 1 021091024
 (C9+5915VU/3)

550x280x320 mm - 2,6 kg

C9/RT

shoulder strap for items
 C4,C7,C9,C10,C10S,C11 and C12



C9/RT 1 021090900

C10 - 2110

technical fabric tool box

Hard frame

Double bottom. Bottom can be removed for increased bag capacity

Tilting handle for easier access to tools

Elastic tool bands and interior and exterior pockets

Cover

Tool tray included in double bottom



C10 1 021100000

2110VU/1 1 021101031
 (C10+5915VU/1)

2110VU/3 1 021101034
 (C10+5915VU/3)

2110VU/AS 1 021101036
 (C10+5915VU/AS)

520x220x250 mm - 3,3 kg

C10S - 2110S

technical fabric tool box

Hard frame

Double bottom. Bottom can be removed for increased bag capacity

Tilting handle for easier access to tools

Elastic tool bands and interior and exterior pockets

Cover

Tool tray included in double bottom



C10S 1 021100001

2110SVU/1 1 021101041
 (C10S+5915VU/1)

2110SVU/3 1 021101044
 (C10S+5915VU/3)

420x220x250 mm - 2,3 kg





C11 - 2111

technical fabric tool box



C11	1	021110000
2111VU/1 (C11+5915VU/1)	1	021111031
2111VU/3 (C11+5915VU/3)	1	021111034

400x240x220 mm - 2 kg

C12 - 2112

technical fabric tool bag

Removable interior tool panel
Elastic tool bands and capacious interior and exterior pockets
Bag opens at front for easier access to tools at workplace
Hard, waterproof base with rubber feet
Can be used with trolley C8



C12	1	021120000
2112ET/A (C12+5980ET/A)	1	021121028
2112ET/B (C12+5980ET/B)	1	021121029
2112VU/5 (C12+5915VU/5)	1	021121056

500x370x270 mm - 5 kg

C13

tool trunk with castors,
made of hard-wearing polypropylene

Suitable for outdoor use
Shockproof, resistant to chemical agents
Can be padlocked



C13

870x410x350 mm - 7,2 kg

C14

tool trolley, made of polypropylene, with 4
drawers

- Injection polypropylene frame for increased shock resistance.
- Lid-protected front accommodates 4 pull-out drawers (470x255):
1 drawer 30 mm high
2 drawers 60 mm high
1 drawer 90 mm high
- Front centralized lock allows top and front lids to be closed simultaneously.
- Two side handles
- 4 sturdy rear castors
- Removable top tray
- Tool panel built into lid
- 3 tote-trays included
- Nameplate
- Can be closed with TSA lock



C14

2114VU/M
(C14+5914VU/M)

580x380x455 mm - 10 kg

CP15 - 2115

tool box, made from plastic, removable tote-
tray and tool trays

- 1 tool tray built into cover
- 2 removable tool trays with adjustable partitions
- 1 interior tote-tray with adjustable partitions



CP15

2115PVU/1
(CP15+5915VU/1)

2115PVU/2
(CP15+5915VU/2)

445x240x250 mm - 2 kg

CP15L - 2115

tool box, long series, made from plastic,
removable tote-tray and tool trays

- 3 tool trays built into cover with adjustable partitions
- 1 interior tote-tray with adjustable partitions



CP15L

2115PL-VU/1
(CP15L+5915VU/1)

2115PL-VU/3
(CP15L+5915VU/3)

558x277x270 mm - 2,5 kg





2115P L-MQ32

assortment of 32 insulated tools for hybrid cars, in plastic tool box with soft thermoformed tray



2115PL-MQ32

1 021150332

920MQ/55A

89MQ 10-12 mm

850MQ 1/4"

860TX/A10 T7-T8-T9-T10-T15-T20-T25-T27-T30-T40

920MQ/A 8-10-12-13-14-17-19 mm

920MQ/21 125mm

920MQ/22 250mm

1048MQ250 250mm

1150MQ 180mm

1164MQ160 160mm

1272MQ 4.5X80-6X100mm

1274MQ 3X100-4X100-5.5X125

1995MQ/G2 G2

CP15L

C16 - 2116

tool box, made of plastic, with interior object compartment, empty



C16

1 021160000

2116VU/1

1 021161102

(C16+5915VU/1)

2116VU/3

1 021161105

(C16+5915VU/3)

500x260x260 mm - 2,5 kg

CP17 - CP17L - 2117

tool box, made of stainless steel and plastic, removable tote-tray



CP17

500x200x220 mm



CP17L

575x245x265 mm

CP17

1 021170500

2117P-VU/1

1 021171042

(CP17+5915VU/1)

2117P-VU/3

1 021171045

(CP17+5915VU/3)

CP17L

1 021170502

2117L-VU/1

1 021171142

(CP17L+5915VU/1)

2117PL-VU/3

1 021171145

(CP17L+5915VU/3)

C18 - 2118

tool box made from sheet metal



C18

1 021180001

2118VU/1

1 021181032

(C18+5915VU/1)

450x200x100 mm - 3 kg

C19 - 2119 - C19L - 2119L

three-section cantilever tool box, made from sheet metal



C19

450x200x160 mm



C19L

550x200x160 mm

C19

1 021190001

2119VU/3

1 021191025

(C19+5915VU/3)

C19L

1 021190002

2119L-VU/3

1 021191125

(C19L+5915VU/3)

C20 - C20L - 2120

five-section cantilever tool box, made from sheet metal



C20

450x200x210 mm



C20L

550x200x210 mm

C20

1 021200001

2120VU/2

1 021201061

(C20+5915VU/2)

2120VU/3

1 021201063

(C20+5915VU/3)

2120VU/4

1 021201064

(C20+5915VU/4)

2120VU/AS

1 021201068

(C20+5915VU/AS)

C20L

1 021200002

2120L-VU/2

1 021201161

(C20L+5915VU/2)

2120L-VU/3

1 021201163

(C20L+5915VU/3)

2120L-VU/4

1 021201164

(C20L+5915VU/4)

2120L-VU/AS

1 021201168

(C20L+5915VU/AS)



C20TSS

five-section cantilever tool box, made of AISI 304 stainless steel



C20TSS

1 021203001

≡ 450x200x210 mm - 4kg

C22B

tool trunk,
made of sheet metal



C22B O
≡ 720x320x310 mm



C22BM O
≡ 850x360x350 mm



C22BL O
≡ 1010x410x400 mm

C22B-O 1 022000150
C22BM-O 1 022000160
C22BL-O 1 022000170

C22B O: 13 kg
C22BM O: 20 kg
C22BL O: 26 kg

C22W

tool trunk,
made from sheet metal,
lined for enhanced tool protection



C22W O
≡ 690x300x360 mm



C22WL O
≡ 990x300x360 mm

C22W-O 1 022000269
C22WL-O 1 022000299

C22W O: 15 kg
C22WL O: 28 kg

C22P

tool trunk for building yards, made of sheet metal

built-in, retractable handles
raised shoes for forklift truck handling
double burglar-proof lock closure (not included)



C22PM O
≡ 915x540x430 mm



C22PL O
≡ 1220x720x615 mm

C22PM-O 1 022000240
C22PL-O 1 022000245

C22PM O: 39 kg
C22PL O: 67 kg





C99

Combo is Beta's new modular system comprised of **3 different types of sturdy tool cases** for replacing your work equipment tidily and totally safely.

The tool cases can be easily joined to each other by a **simple click**, through the functional side snap-on mechanism.

The new system, Beta Combo C99, is compatible with the L-BOXX standard by Sortimo®.

C99V1

wall tool case, made from ABS

Main features:

- Outer dimensions: 445x358x152 mm
- Max. interior carrying capacity: 25 kg
- Can be padlocked
- Weight: 2.2 kg

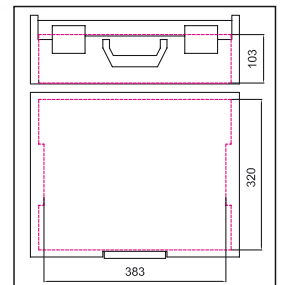

C99V1

1 099000250

C99V2

wall tool case, made from ABS

Main features:

- Outer dimensions: 445x358x254 mm
- Max. interior carrying capacity: 25 kg
- Weight: 2.8 kg

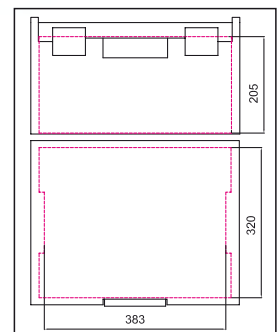

C99V2

1 099000350

C99V3/2C

wall tool case, made from ABS, with 2 portable tote trays

Main features:

- Outer dimensions: 445x358x322 mm
- Max. interior carrying capacity: 25 kg
- Supplied with 2 tote trays C99C-V3, empty
- Weight: 5.6 kg

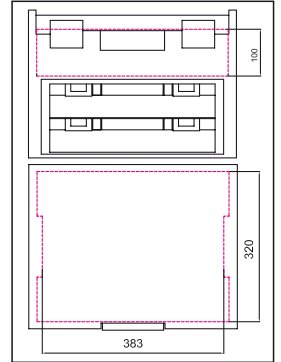

C99V3/2C

1 099000450

C99C-V3

portable tool box

Transparent cover for quick identification of contents

Built-in handle

Outer dimensions: 367x316x72 mm

Weight: 0.9 kg

Can be equipped with:

- 7 compartment thermoformed tote tray C99T-V3
- kit of 17 tote trays item C99P-V3

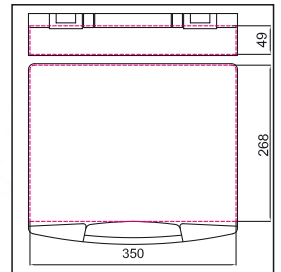

C99C-V3

1 099000496

C99P

folding tool trolley, made of aluminium

Main features:

- Ultracompact folding tool trolley, made of anodized aluminium
- Telescopic handle
- Dimensions when open: 485x520x1195 mm
- Dimensions when closed: 485x60x905 mm
- Dimensions of folding base: 485x350 mm
- Two puncture proof wheels, Ø 175 mm
- Supplied with strap
- Maximum capacity: 120 kg
- Weight: 5.1 kg



C99P

1 099000101

C99PC

cover lining for wall tool cases C99V1 and C99V3/2C

Required in combination with thermoformed trays, to prevent the contents from coming out of the compartments or getting mixed up during transportation.



C99PC

1 099000491

C99T

thermoformed tote tray, 4-compartment, for tool cases C99V1 and C99V3/2C



C99T

1 099000492

C99M

soft foam insert, pre-cubed, for tool cases C99V1, C99V2 and C99V3/2C

Easy to shape, for safe, customized accommodation of any tools

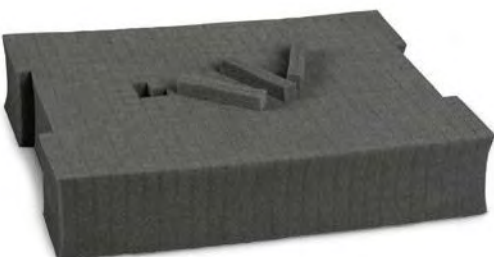

C99M

1 099000494

C99T-V3

thermoformed tote tray with 7 compartments, for tool boxes C99C-V3



C99T-V3

1 099000497

C99P-V3

kit of 17 tote trays for tool boxes C99C-V3

Kit contents:

- 6 red trays 52x52 mm
- 2 yellow trays 104x52 mm
- 3 grey trays 78x260 mm and 6 partitions



C99P-V3

1 099000498

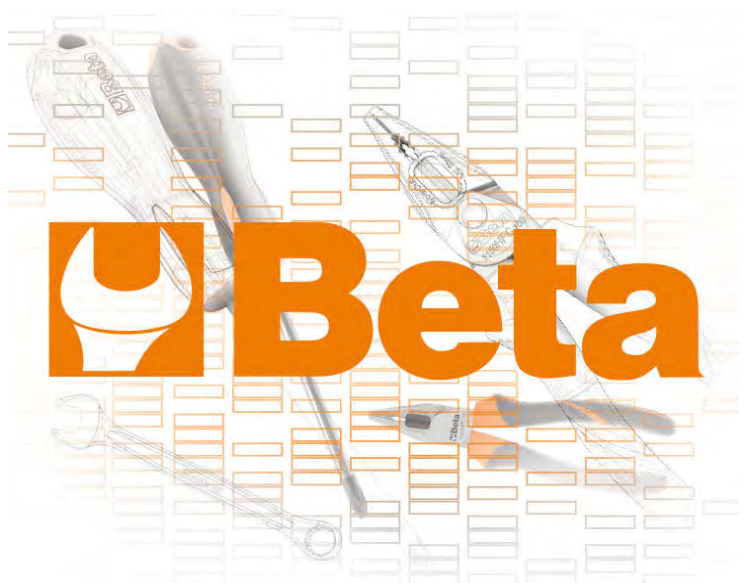

C22S

portable tool chest
with three drawers

Main features:

- Three drawers (588x277 mm) with ball bearing slides:
- 1 drawer, 50 mm high
- 2 drawers, 70 mm high.
- Front centralized safety lock.
- Retractable side handles for ease of handling.

19 kg



C22S-O



C22S-G



C22S-R

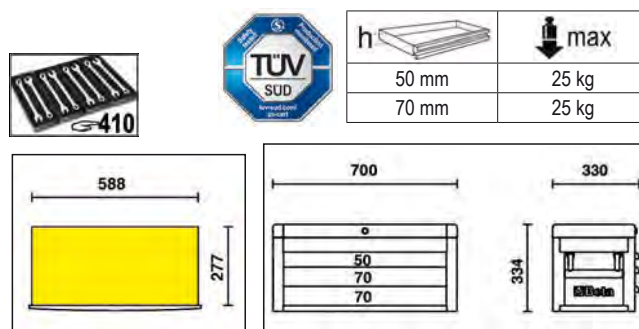

C22S-O	1	022000501
C22S-G	1	022000502
C22S-R	1	022000503

C23S

portable tool chest
with five drawers

Main features:

- Five drawers (588x277 mm) with ball bearing slides:
- 2 drawers, 50 mm high
- 3 drawers, 70 mm high.
- Front centralized safety lock.
- Retractable side handles for ease of handling.

26 kg



C23S-G



C23S-R



C23S-O

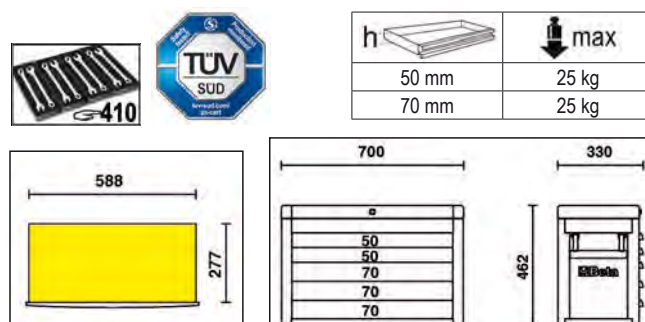

C23S-O	1	023000501
C23S-G	1	023000502
C23S-R	1	023000503

CD23S

Caddy trolley

Main features:

- ABS worktop designed to match tool chests C22S, C23S, C23SC.
- The removable handle can be stored underneath the chassis.
- Four castors 125 mm in Ø:
- 2 fixed and 2 steering (one with brake).
- Maximum load: 250 kg.

14 kg



CD23S	1	023000610
-------	---	-----------

C23SC

portable tool chest
with eight drawers

Main features:

- Eight drawers with ball bearing slides:
4 drawers, 50 mm high
3 drawers, 70 mm high
1 drawer, 100 mm high.
- Front centralized safety lock.
- Retractable side handles for ease of transport.

28 kg

C23SC-O	1	023000511
C23SC-G	1	023000512
C23SC-R	1	023000513



C23SC-G



C23SC-R



C23SC-O



h	max
50 mm	25 kg
70 mm	25 kg

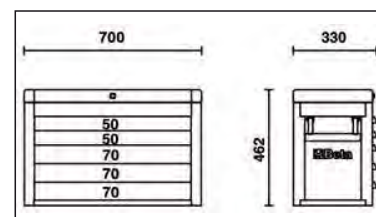
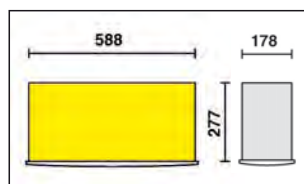

C23ST

portable tool chest
with five drawers

Main features:

- Five drawers (588x367 mm) with ball bearing slides:
5 drawers, 70 mm high.
- Front centralized safety lock.
- Can be fitted with kit composed of 4 castors and 1 handle (2300ST/KIT)

36 kg

C23ST-O	1	023000521
C23ST-G	1	023000522
C23ST-R	1	023000523



C23ST-G



C23ST-R



C23ST-O



h	max
70 mm	25 kg

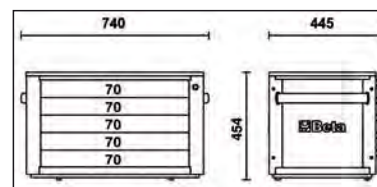
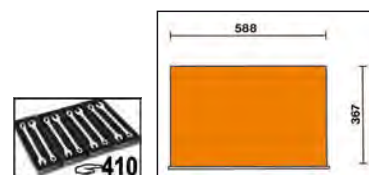

2300ST/KIT

kit with 4 castors and 1 handle for item C23ST

- Four castors 125 mm in Ø:
2 fixed and 2 steering (two with brakes).
- Telescopic handle

6,5 kg

2300ST/KIT	1	023000950
------------	---	-----------



C24S/5

mobile roller cab with five drawers

Main features:

- Five drawers (588x367 mm) with ball bearing slides:
 - 2 drawers, 70 mm high
 - 2 drawers, 140 mm high
 - 1 drawer, 280 mm high
- Drawer bases protected by foamed rubber mats.
- Four castors 125 mm in Ø:
- 2 fixed and 2 steering (one with brake).
- Front centralized safety lock.
- Static load capacity: 800 kg.
- Thermoplastic worktop designed to match tool chests C22S, C23S, C23SC and C23ST
- Integrated side bottle holder.
- Paper roll holder item 2400S-R/PC can also be included.

52 kg

800 kg



C24S/5-O



C24S/5-G



C24S/5-R

h	max
70 mm	25 kg
140 mm	30 kg
280 mm	35 kg

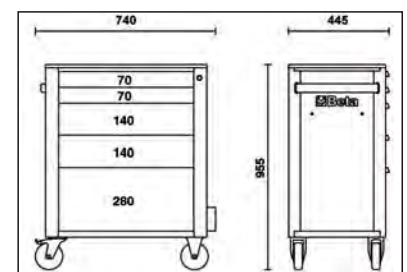
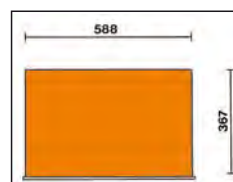

C24S/5-O	1	024002051
C24S/5-G	1	024002052
C24S/5-R	1	024002053

C24S/6

mobile roller cab with six drawers

Main features:

- Six drawers (588x367 mm) with ball bearing slides:
 - 4 drawers, 70 mm high
 - 1 drawer, 140 mm high
 - 1 drawer, 280 mm high
- Drawer bases protected by foamed rubber mats.
- Four castors 125 mm in Ø:
 - 2 fixed and 2 steering (one with brake).
- Front centralized safety lock.
- Static load capacity: 800 kg.
- Thermoplastic worktop designed to match tool chests C22S, C23S, C23SC and C23ST.
- Integrated side bottle holder.
- Paper roll holder item 2400S-R/PC can also be included.



55 kg



C24S/6-O



C24S/6-G



C24S/6-R

h	max
70 mm	25 kg
140 mm	30 kg
280 mm	35 kg

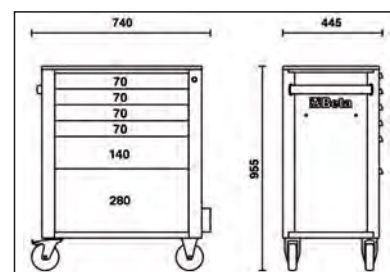
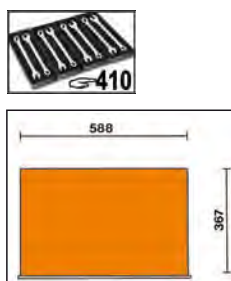

C24S/6-O	1	024002061
C24S/6-G	1	024002062
C24S/6-R	1	024002063

C24S/7

mobile roller cab with seven drawers

Main features:

- Seven drawers (588x367 mm) with ball bearing slides:
 - 5 drawers, 70 mm high
 - 1 drawer, 140 mm high
 - 1 drawer, 210 mm high
- Drawer bases protected by foamed rubber mats.
- Four castors 125 mm in Ø:
 - 2 fixed and 2 steering (one with brake).
- Front centralized safety lock.
- Static load capacity: 800 kg.
- Thermoplastic worktop designed to match tool chests C22S, C23S, C23SC and C23ST
- Integrated side bottle holder.
- Paper roll holder item 2400S-R/PC can also be included.

58 kg

800 kg



C24S/7-O



C24S/7-G



C24S/7-R



C24S/7-B



C24S/7-N

h	max
70 mm	25 kg
140 mm	30 kg
210 mm	30 kg

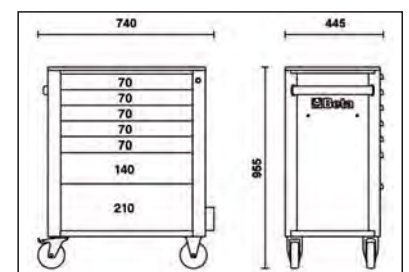
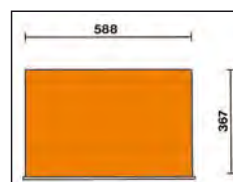

Model	Quantity	Part Number
C24S/7-O	1	024002071
C24S/7-G	1	024002072
C24S/7-R	1	024002073
C24S/7-B	1	024002076
C24S/7-N	1	024002079

C24S/8

mobile roller cab with eight drawers

Main features:

- Eight drawers (588x367 mm) with ball bearing slides:
- 6 drawers, 70 mm high
- 2 drawers, 140 mm high
- Drawer bases protected by foamed rubber mats.
- Four castors 125 mm in Ø:
- 2 fixed and 2 steering (one with brake).
- Front centralized safety lock.
- Static load capacity: 800 kg.
- Thermoplastic worktop designed to match tool chests C22S, C23S, C23SC and C23ST.
- Integrated side bottle holder.
- Paper roll holder item 2400S-R/PC can also be included.

61 kg



C24S/8-O



C24S/8-G



C24S/8-R

h	max
70 mm	25 kg
140 mm	30 kg

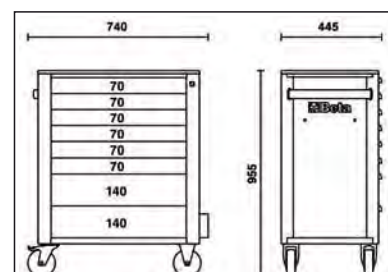
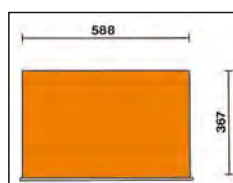

C24S/8-O	1	024002081
C24S/8-G	1	024002082
C24S/8-R	1	024002083

C24SA/6

mobile roller cab with six drawers,
with anti-tilt system

Main features:

- Six drawers (588x367 mm), with ball bearing slides:
 - 4 drawers, 70 mm high
 - 1 drawer, 140 mm high
 - 1 drawer, 280 mm high.
- Drawer bases protected by foamed rubber mats.
- Four castors Ø 125 mm:
 - 2 fixed and 2 steering (one with brake).
- Front centralized safety lock.
- Static load capacity: 800 kg.
- Thermoplastic worktop designed to match tool chests C22S, C23S, C23SC and C23ST
- Integrated side bottle holder.
- Paper roll holder item 2400S-R/PC can also be included.

55 kg

800 kg



C24SA/6-O



C24SA/6-G



C24SA/6-R

h	max
70 mm	25 kg
140 mm	30 kg
280 mm	35 kg

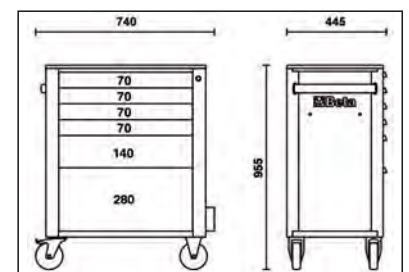
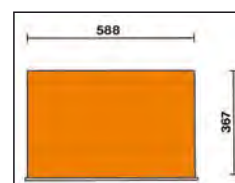

C24SA/6-O	1	024002161
C24SA/6-G	1	024002162
C24SA/6-R	1	024002163

C24SA/7

mobile roller cab with 7 drawers,
with anti-tilt system

Main features:

- Seven drawers (588x367 mm) with ball bearing slides:
 - 5 drawers, 70 mm high
 - 1 drawer, 140 mm high
 - 1 drawer, 210 mm high
- Drawer bases protected by foamed rubber mats.
- Does not allow simultaneous opening of several drawers
- Four castors 125 mm in Ø:
 - 2 fixed and 2 steering (one with brake)
- Front centralized safety lock
- Static load capacity: 800 kg
- Integrated side bottle holder

58 kg

800 kg



C24SA/7-O



C24SA/7-G



C24SA/7-R

h	max
70 mm	25 kg
140 mm	30 kg
210 mm	30 kg

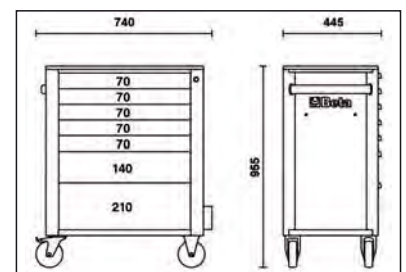
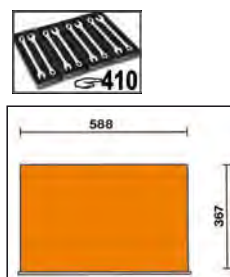

C24SA/7-O	1	024002171
C24SA/7-G	1	024002172
C24SA/7-R	1	024002173

C24SA/8

mobile roller cab with eight drawers,
with anti-tilt system

Main features:

- 8 drawers (588x367 mm), with ball bearing slides:
 - 6 drawers, 70 mm high
 - 2 drawers, 140 mm high.
- Drawer bases protected by foamed rubber mats.
- Four castors Ø 125 mm:
 - 2 fixed and 2 steering (one with brake).
- Front centralized safety lock.
- Static load capacity: 800 kg.
- Thermoplastic worktop designed to match tool chests C22S, C23S, C23SC and C23ST.
- Integrated side bottle holder.
- Paper roll holder item 2400S-R/PC can also be included.

61 kg

800 kg



C24SA/8-O



C24SA/8-G



C24SA/8-R

h	max
70 mm	25 kg
140 mm	30 kg

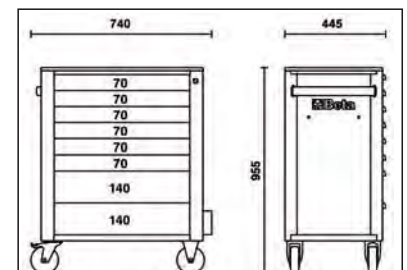
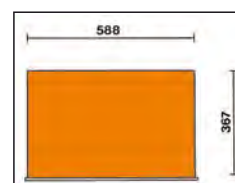

C24SA/8-O	1	024002181
C24SA/8-G	1	024002182
C24SA/8-R	1	024002183

C24SA-XL/7

mobile roller cab with 7 drawers,
with anti-tilt system,
long model

Main features:

- 7 drawers (882x367) mm, with ball bearing slides:
- 5 drawers, 70 mm high
- 1 drawer, 140 mm high
- 1 drawer, 210 mm high
- Sturdy ABS worktop, with 6 tool trays.
- Sturdy nylon front, with integrated label holder.
- Drawer bases protected by foamed rubber mats.
- Four castors 125 mm in Ø:
- 2 fixed and 2 steering (one with brake).
- Front centralized safety lock.
- Static load capacity: 1,000 kg.
- Integrated side bottle holder.

84 kg

1000 kg



C24SAXL7-O



C24SAXL7-G



C24SAXL7-R

h	max
70 mm	30 kg
140 mm	35 kg
210 mm	35 kg

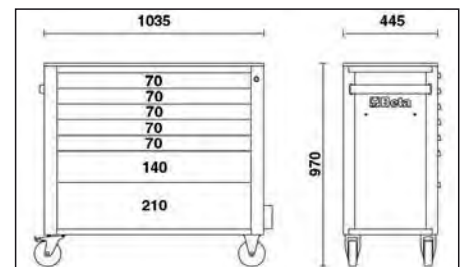
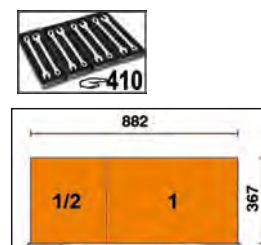

C24SAXL7-O	1	024002271
C24SAXL7-G	1	024002272
C24SAXL7-R	1	024002273

C24SA-XL/8

mobile roller cab with eight drawers,
with anti-tilt system,
long model

Main features:

- 8 drawers (882x367 mm), with ball bearing slides: 6 drawers, 70 mm high 2 drawers, 140 mm high.
- Sturdy ABS worktop, with 6 tool trays.
- Sturdy nylon front, with integrated label holder.
- Drawer bases protected by foamed rubber mats.
- Four castors Ø 125 mm: 2 fixed and 2 steering (one with brake).
- Front centralized safety lock.
- Static load capacity: 1,000 kg.
- Integrated side bottle holder.
- Paper roll holder item 2400S-R/PC can also be included.

88 kg

1000 kg



C24SAXL/8-O



C24SAXL/8-G



C24SAXL/8-R

h	max
70 mm	30 kg
140 mm	35 kg

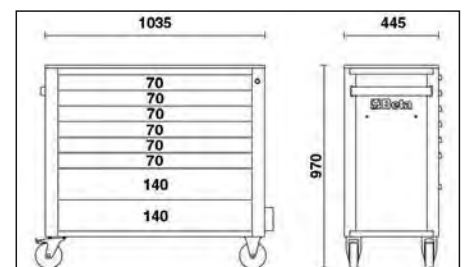
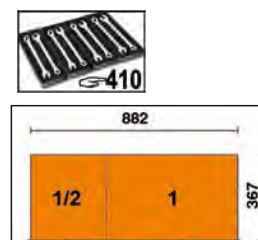

C24SAXL/8-O	1	024002281
C24SAXL/8-G	1	024002282
C24SAXL/8-R	1	024002283

C24SA-XL/9

mobile roller cab with nine drawers,
with anti-tilt system,
long model

Main features:

- 9 drawers (882x367 mm), with ball bearing slides: 8 drawers, 70 mm high
1 drawer, 140 mm high
- Sturdy ABS worktop, with 6 tote-trays.
- Sturdy nylon front, with built-in label holder.
- Drawer bases protected by foamed rubber mats.
- Four castors Ø 125 mm: 2 fixed and 2 steering (one with brake).
- Front centralized safety lock.
- Static load capacity: 1,000 kg.
- Built-in side bottle holder.
- Paper roll holder item 2400S-R/PC can also be included.

90 kg

1000 kg



C24SAXL/9-O



C24SAXL/9-G



C24SAXL/9-R

h	max
70 mm	30 kg
140 mm	35 kg

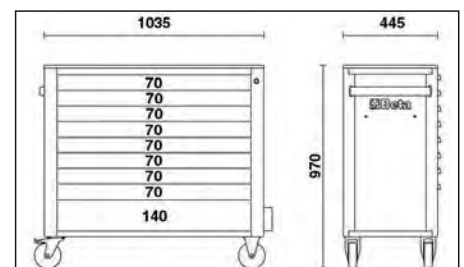
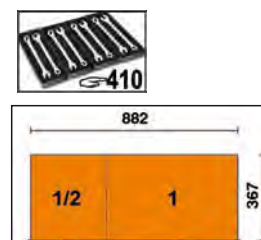

C24SAXL/9-O	1	024002331
C24SAXL/9-G	1	024002332
C24SAXL/9-R	1	024002333

2400S-R/PC

paper roll holder

- Matches roller cabs C24S

0,3 kg

2400SR/PC-O	1	024002951
2400SR/PC-G	1	024002952
2400SR/PC-R	1	024002953



- 2400S R/PC-O
- 2400S R/PC-G
- 2400S R/PC-R



2400S/PF

bottle holder

- Matches roller cabs C24S

0,5 kg

2400S/PF	1	024002906
----------	---	-----------



2499PF

bottle holder

- Can match roller cabs C38, C38A

2,5 kg

2499PF-O	1	024990210
2499PF-G	1	024990219
2499PF-R	1	024990230

2499PF O

2499PF G

2499PF R



2499PF/M

universal magnetic bottle holder

2,2 kg

2499PF/M	1	024990050
----------	---	-----------



2499PC

paper roll holder

- Matches all Tank and roller cabs and C38, C38A.

2,2 kg

2499PC	1	024990090
--------	---	-----------



C24SL

mobile roller cab
with seven drawers
and side tops

Main features:

- Seven drawers (588x367 mm) with ball bearing slides:
 - 5 drawers, 70 mm high
 - 1 drawer, 140 mm high
 - 1 drawer, 210 mm high.
- Drawer bases protected by foamed rubber mats.
- Four castors 125 mm in Ø:
 - 2 fixed and 2 steering (two with brakes).
- Front centralized safety lock.
- Static load capacity: 1.100 kg.
- Multi-ply wood worktop with holes for a vice (1599F/100, to be ordered separately).
- Side compartment with vertically adjustable top.
- Integrated paper roll holder.
- Double rear bottle holder.

80 kg

C24SL-O	1	024002101
C24SL-G	1	024002102
C24SL-R	1	024002103

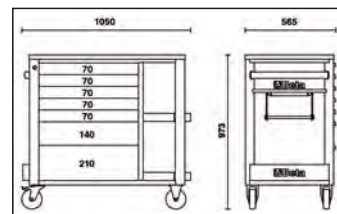
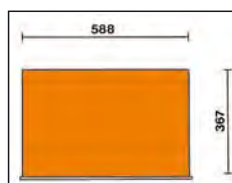

C24SL-CAB

mobile roller cab
with seven drawers
and tool cabinet

Main features:

- Seven drawers (588x367 mm) with ball bearing slides:
 - 5 drawers 70 mm high
 - 1 drawer 140 mm high
 - 1 drawer 210 mm high.
- Drawer bases protected by foamed rubber mats.
- Four castors, Ø 125 mm:
 - 2 fixed and 2 steering (two with brakes).
- Front centralized lock.
- Side tool cabinet with lockable door and vertically adjustable interior top.
- Static load capacity: 1,100 kg.
- Multi-ply wood worktop with holes for a vice (1599F/100, to be ordered separately).
- Built-in paper roll holder.
- Double rear bottle holder.

82 kg

C24SL-CAB/O	1	024002191
C24SL-CAB/G	1	024002192
C24SL-CAB/R	1	024002193

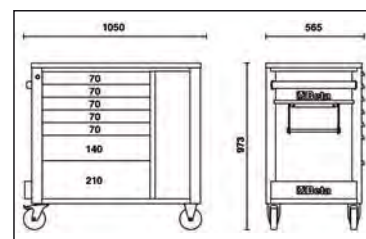
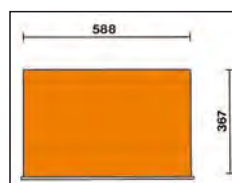

C04TSS-7

mobile roller cab with seven drawers, made entirely of stainless steel,
Non-marking wheels

Main features:

- Seven drawers (570 x 410 mm) with ball bearing slides;
- 6 drawers, 83 mm high;
- 1 drawer, 170 mm high;
- 4 castors Ø 125 mm
- 2 fixed and 2 steering (two with brakes);
- Front centralized lock;
- Frame made entirely of stainless steel AISI 304
- Castors, supports, ball bearings, drawer interiors and guides made of stainless steel
- Drawer handles made of aluminium

63 kg

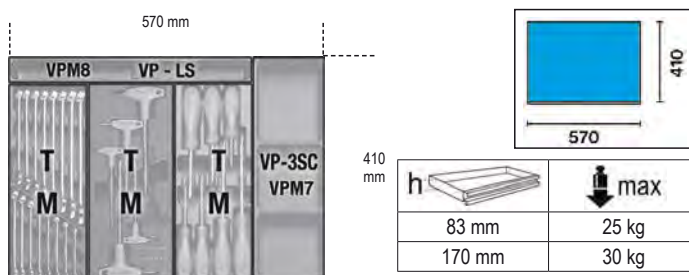

C04TSS/7

1

024003077

279

C25

Tank trolley with shelf

Main features:

- Foldaway lid.
- 1 sliding drawer.
- Tool tray protected by foamed rubber mats.
- Shelves protected by oil and fuel proof mats.
- Four castors 100 mm in ø:
- 2 fixed and 2 swivelling (one with brake).
- Safety lock.
- One more shelf M4 can be added on the opposite side.
- Empty thermoformed tray for 1/2" sockets and accessories (024990104).
- Paper roll holder item 2499PC can also be included

31,5 kg

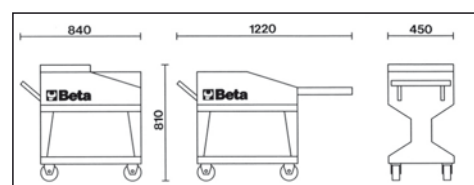

C25

1

025000001

C27S

folding tool trolley for outdoor jobs

Folding tool trolley. Its unique patented design guarantees an effortless transport.

2 drawers, 588x277 mm, with ball bearing slides for two-way opening.

Large lower object compartment, 588x277x220 mm.

Sheet metal frame.

2 fixed castors, Ø 160 mm, and 2 steering castors with brake, Ø 100 mm

Thermoplastic worktop with 6 built-in tool trays.

Centralized lock.

Can accommodate drawer partitions and MC foam tool trays

20 kg



C27S-O



C27S-G



C27S-R



h	max
70 mm	20 kg

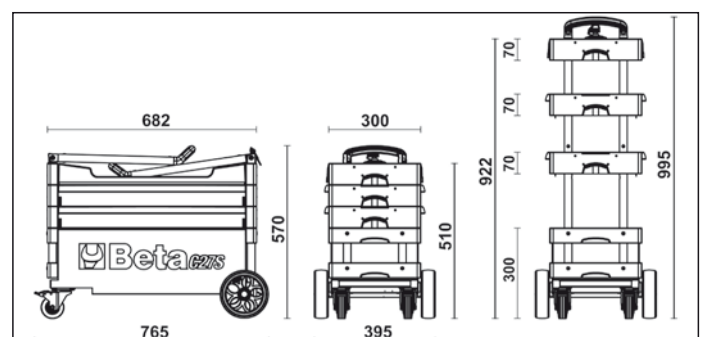
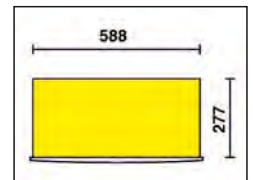

C27S-O	1	027000201
C27S-G	1	027000202
C27S-R	1	027000203

C28

SuperTank trolley with worktop and ten drawers

Main features:

- Ten drawers (588x367 mm) with ball bearing slides
- Quick, safe system for opening and closing drawers, with nylon and fibreglass front
- Five side drawers:
 - 4 drawers, 70 mm high
 - 1 drawer, 210 mm high
- Five front drawers:
 - 4 drawers, 70 mm high
 - 1 drawer, 210 mm high
- Drawer bases protected by foamed rubber mats
- Four high-capacity castors 150 mm in Ø:
 - 2 fixed and 2 steering (with brakes)
- 2 centralised safety locks
- Multiply wood worktop with holes for a vice (1599F/150, to be ordered separately)
- 4 bottle holders: 2 front and 2 rear
- 6 side tool trays
- Side compartment with foldaway door with lock
- 135-mm-high storage compartment with plastic-covered base
- Static load capacity: 1200 kg

1200
kg



C28-O

130 kg



C28-G



C28-R



410

h	max
70 mm	25 kg
210 mm	30 kg

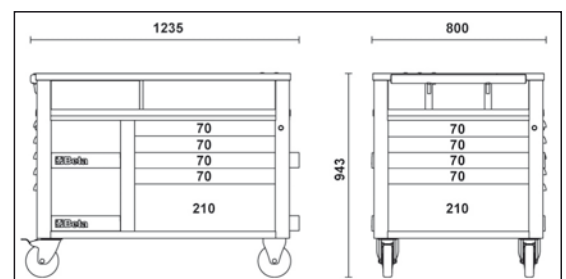
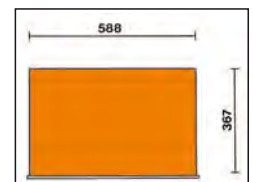

C28-O	1	028000301
C28-G	1	028000302
C28-R	1	028000303

C30S

MaxiTank mobile workbench

Main features:

- 5 front drawers with ball bearing slides:
 - 3 drawers (367x588 mm), 90 mm high
 - 1 drawer (610x588 mm), 90 mm high
 - 1 drawer (610x588 mm), 180 mm high.
- Quick opening system with aluminium front.
- Drawer bases protected by foamed rubber mats.
- Can accommodate thermoformed trays.
- One hydraulic jack, designed to lift front part easily.
- Four high-capacity castors:
 - 2 steering, front, Ø 150 mm
 - 2 fixed, rear, Ø 170 mm.
- Oil-proof, rubber-coated worktop, 1300x800 mm, with drain hole for fluid collection in a small tank.
- Can accommodate vice item 1599F/150 (to be ordered separately).
- Storage compartment, 720x250x1300 mm, with PVC-coated worktop, and front sliding panels.
- Centralized lock for drawers and panels.
- Integrated side bottle holders.
- Integrated paper roll holder.
- Static load capacity: 1,800 kg.
- Can accommodate a multi-ply wood worktop (3000 S/PLM), to be ordered separately.
- Can accommodate vice item 1599F/150 (to be ordered separately).



1800
kg

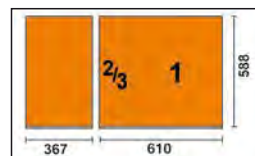

 **200 kg**

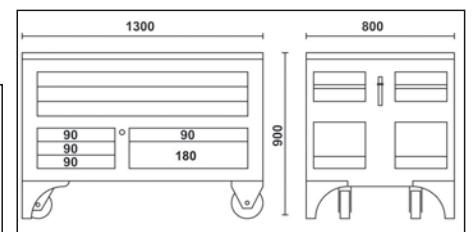

h	max
90 mm	30 kg
180 mm	35 kg



C30S

 **1**  030000100

3000S/PLM

wood worktop for item C30S

 **10 kg**



 1240x740x26 mm

3000S/PLM

 **1**  030000150

C35/6G

industrial tool chest with six drawers

Main features:

- Six pull-out drawers (600x447 mm):
 - 2 drawers, 75 mm high
 - 1 drawer, 100 mm high
 - 1 drawer, 150 mm high
 - 1 drawer, 200 mm high
 - 1 drawer, 300mm high
- Front centralized safety lock.
- Can accommodate an ABS worktop and drawer partitions, to be ordered separately.

73,5 kg

1200 kg



h	max
75 mm	70 kg
100 mm	70 kg
150 mm	70 kg
200 mm	70 kg
300 mm	70 kg

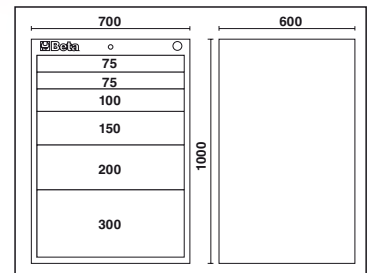
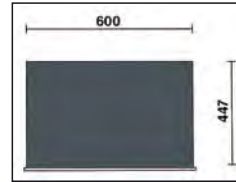

C35/6G



035000062

C35/7G

industrial tool chest with seven drawers

Main features:

- Seven pull-out drawers (600x447 mm):
 - 2 drawers, 75 mm high
 - 1 drawer, 100 mm high
 - 3 drawers, 150 mm high
 - 1 drawer, 200 mm high
- Front centralized safety lock.
- Can accommodate an ABS worktop and drawer partitions, to be ordered separately.

77 kg

1200 kg



h	max
75 mm	70 kg
100 mm	70 kg
150 mm	70 kg
200 mm	70 kg

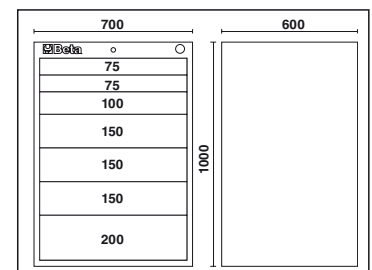
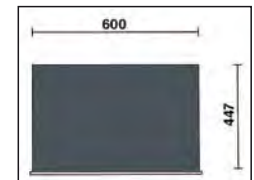

C35/7G



035000072

C35/8G

industrial tool chest with eight drawers

Main features:

- Eight pull-out drawers (600x447 mm):
4 drawers, 75 mm high
1 drawer, 100 mm high
2 drawers, 150 mm high
1 drawer, 200 mm high
- Front centralized safety lock.
- Can accommodate an ABS worktop and drawer partitions, to be ordered separately.

📦 80,5 kg

1200 kg



h	max
75 mm	70 kg
100 mm	70 kg
150 mm	70 kg
200 mm	70 kg

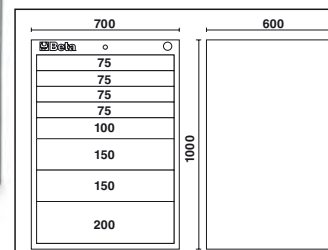
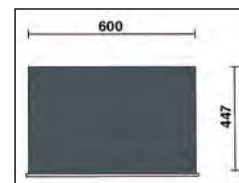

C35/8G

1 035000082

C35/9G

industrial tool chest with nine drawers

Main features:

- Nine pull-out drawers (600x447 mm):
6 drawers, 75 mm high
3 drawers, 150 mm high
- Front centralized safety lock.
- Can accommodate an ABS worktop and drawer partitions, to be ordered separately.

📦 84 kg

1200 kg



h	max
75 mm	70 kg
150 mm	70 kg

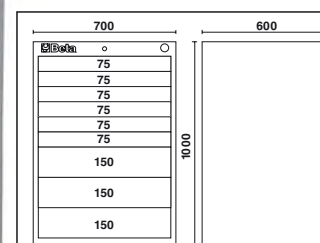
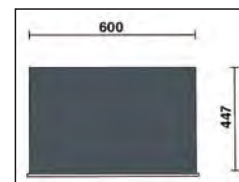

C35/9G

1 035000092

3500/P

Worktop with edge for tool chest C35

3500/P 700x600 mm

1 035000502



3500/D

adapters for drawer C35

Allow dimensions of drawer of tool chest C35 to be adapted, so that all standard foam trays can be used



3500/D

1 035000503

C37/6

mobile roller cab
with 6 drawers

Main features:

- 6 drawers (588x367 mm) with ball bearing slides:
- 4 drawers 75 mm high
- 1 drawer 150 mm high
- 1 drawer 305 mm high
- Sturdy multi-purpose worktop.
- Tote-trays and holes for accommodating screwdrivers.
- Convenient "V"-shaped groove for working pipes and sections.
- Quick release system made of aluminium, opening throughout length of drawer.
- Corner bumpers throughout height of roller cab, to avoid damaging vehicles in garage.
- Drawer bases protected by foamed rubber mats.
- Four castors Ø 125 mm:
- 2 fixed and 2 steering (one with brake).
- Front centralized safety lock.
- Static load capacity: 1000 kg.
- Built-in side bottle and paper holders, adjustable in several positions.

1000
kg



C37/6-O

69 kg



C37/6-G



C37/6-R

h	max
75 mm	30 kg
150 mm	35 kg
305 mm	40 kg

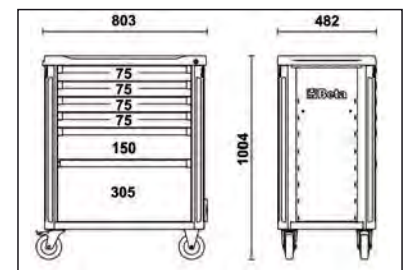
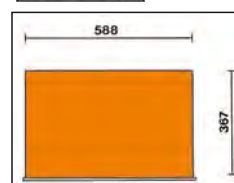

C37/6-O	1	037000061
C37/6-G	1	037000062
C37/6-R	1	037000063

C37/7

mobile roller cab
with 7 drawers

Main features:

- 7 drawers (588x367 mm) with ball bearing slides:
- 5 drawers 75 mm high
- 1 drawer 150 mm high
- 1 drawer 225 mm high
- Sturdy multi-purpose worktop.
- Tote-trays and holes for accommodating screwdrivers.
- Convenient "V"-shaped groove for working pipes and sections.
- Quick release system made of aluminium, opening throughout length of drawer.
- Corner bumpers throughout height of roller cab, to avoid damaging vehicles in garage.
- Drawer bases protected by foamed rubber mats.
- Four castors Ø 125 mm:
- 2 fixed and 2 steering (one with brake).
- Front centralized safety lock.
- Static load capacity: 1000 kg.
- Built-in side bottle and paper holders, adjustable in several positions.

1000
kg



C37/7-O

71 kg



C37/7-G



C37/7-R

h	max
75 mm	30 kg
150 mm	35 kg
225 mm	35 kg

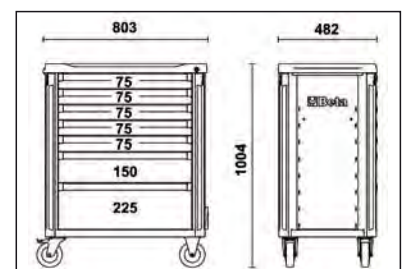
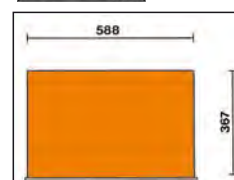

C37/7-O	1	037000071
C37/7-G	1	037000072
C37/7-R	1	037000073

C37/8

mobile roller cab
with 8 drawers

Main features:

- 8 drawers (588x367 mm) with ball bearing slides:
- 6 drawers 75 mm high
- 2 drawers 150 mm high
- Sturdy multi-purpose worktop.
- Tote-trays and holes for accommodating screwdrivers.
- Convenient "V"-shaped groove for working pipes and sections.
- Quick release system made of aluminium, opening throughout length of drawer.
- Corner bumpers throughout height of roller cab, to avoid damaging vehicles in garage.
- Drawer bases protected by foamed rubber mats.
- Four castors Ø 125 mm:
- 2 fixed and 2 steering (one with brake).
- Front centralized safety lock.
- Static load capacity: 1000 kg.
- Built-in side bottle and paper holders, adjustable in several positions.

1000
kg



C378-O

73 kg



C37/8-G



C37/8-R

h	max
75 mm	30 kg
150 mm	35 kg

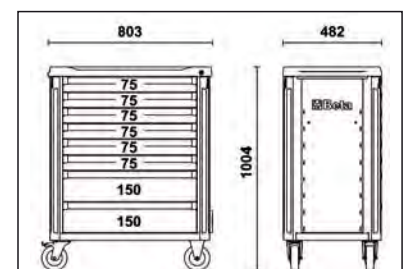
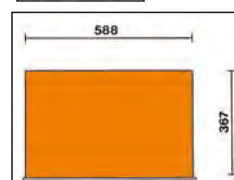

C37/8-O	1	037000081
C37/8-G	1	037000082
C37/8-R	1	037000083

C37A/7

mobile roller cab
with 7 drawers, with anti-tilt system

Main features:

- 7 drawers (588x367 mm), with ball bearing slides:
- 5 drawers 75 mm high
- 1 drawer 150 mm high
- 1 drawer 225 mm high
- Sturdy multi-purpose worktop.
- Tote trays and holes for accommodating screwdrivers.
- Quick release system made of aluminium, opening throughout length of drawer.
- Soft corner bumpers throughout height of roller cab, to avoid damaging vehicles in garage.
- Drawer bases protected by foamed rubber mats.
- Four castors Ø 125 mm:
- 2 fixed and 2 steering (one with brake).
- Front centralized safety lock.
- Static load capacity: 1000 kg.
- Built-in side bottle and paper holders, adjustable in several positions.

71 kg

1000 kg



C37A/7-O



C37A/7-G



C37A/7-R

h	max
75 mm	30 kg
150 mm	35 kg
225 mm	35 kg

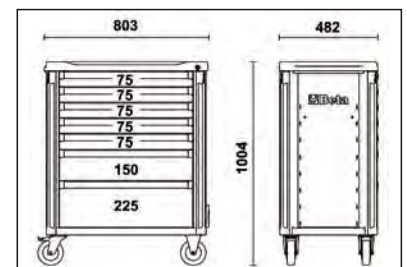
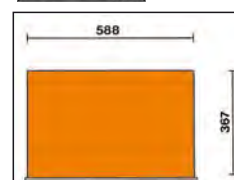

C37A/7-O	1	037000271
C37A/7-G	1	037000272
C37A/7-R	1	037000273

3700/PLA

stainless steel worktop for mobile roller cab item C37

2,8 kg

3700/PLA 1 037000100



672x396x1,5 mm

3700/PLL

wood worktop for mobile roller cab item C37

3,9 kg

3700/PLL 1 037000101



672x396x28 mm

3700/PF

perforated panel with brackets for mobile roller cab item C37

3,2 kg

3700/PF 1 037000102



626
80
650



496

3700/PFL

perforated side panel for mobile roller cab item C37

1,9 kg

3700/PFL 1 037000104



496

754
52
321



3700/PC

computer bracket for mobile roller cab item C37

3,1 kg

3700/PC 1 037000103

303
389
418



C38

mobile roller cab
with eleven drawers

Main features:

- Eleven drawers with ball bearing slides:
- 1 drawer 937x410x122 mm
- 3 drawers 570x410x74 mm
- 2 drawers 570x410x153 mm
- 3 drawers 313x410x74 mm
- 2 drawers 313x410x153 mm.
- Drawer bases protected by foamed rubber mats.
- Static load capacity: 1200 kg.
- 4 high-capacity castors: Ø 125 mm:
- 2 fixed and 2 steering (both with lever brake).
- Front centralized lock.
- Sheet metal worktop covered by a rubber mat.
- Can be fitted with paper roll holder item 2499PC and bottle holder item 2499PF.

114 kg

C38-O	1	038000001
C38-G	1	038000003
C38-R	1	038000002



h	max
74 mm	25 kg
153 mm	30 kg

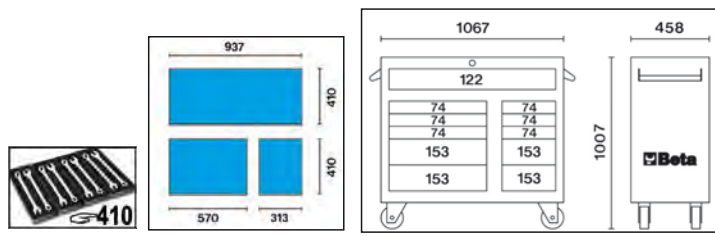

C38L

side cab with seven drawers

Main features:

- Seven drawers (410x313 mm) with ball bearing slides:
- 5 drawers, 74 mm high
- 2 drawers, 153 mm high
- Drawer bases protected by foamed rubber mats.
- Front centralized safety lock.
- Antislip aluminium worktop.
- Can be placed on both sides of roller cab C38 and C38A.

45 kg

C38L-O	1	038000081
C38L-G	1	038000083
C38L-R	1	038000082

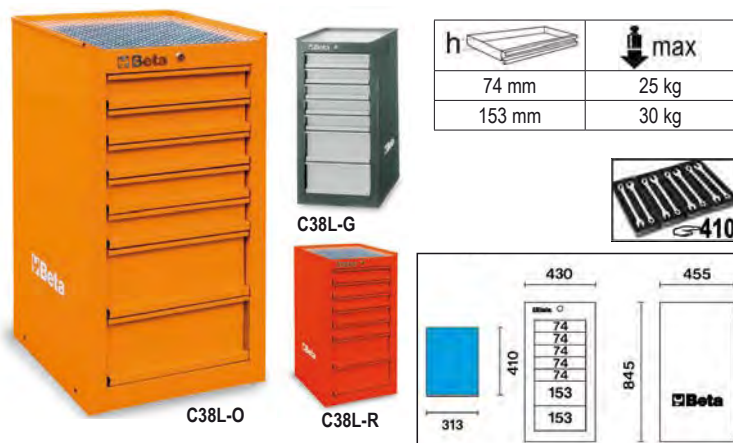

h	max
74 mm	25 kg
153 mm	30 kg

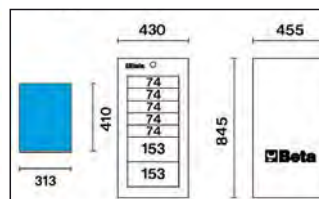

C38LA

side door
with interior shelf

Main features:

- Front lock.
- Vertically adjustable interior shelf.
- Inside door document pocket.
- Antislip aluminium worktop.
- Can be placed on both sides of roller cab C38.

18 kg

C38LA O	1	038000071
C38LA G	1	038000073
C38LA R	1	038000072

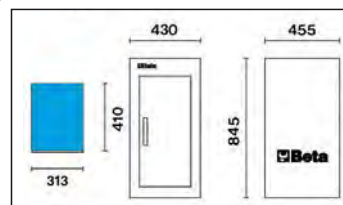

C38C

mobile roller cab

with thirty three drawers,
comprising:

- 1 mobile roller cab C38
- 2 side cabs C38L
- 1 cab C38T with top chest

268 kg



C38C-O



C38C-G



C38C-R



h	max
74 mm	25 kg
153 mm	30 kg

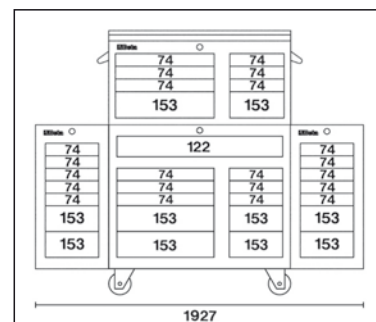
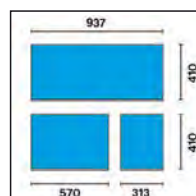

C38C-O	1	038000201
C38C-G	1	038000203
C38C-R	1	038000202

C38T

cab

with eight drawers and top chest

Main features:

- Eight drawers with ball bearing slides:
3 drawers 570x410x74 mm
1 drawer 570x410x153 mm
3 drawers 313x410x74 mm
1 drawer 313x410x153 mm.
- Tool compartment.
- Drawer bases protected by foamed rubber mats.
- Front centralized safety lock.
- Antislip aluminium worktop.
- Can be placed on roller cab C38 and C38A.

64 kg



C38T-O



C38T-G



C38T-R

h	max
74 mm	25 kg
153 mm	30 kg

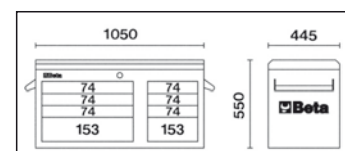
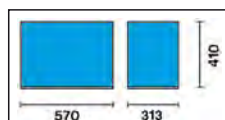

C38T-O	1	038000091
C38T-G	1	038000093
C38T-R	1	038000092

C39/6

mobile roller cab with six drawers

Main features:

- Six drawers (588x367 mm) with ball bearing slides:
 - 4 drawers, 70 mm high
 - 1 drawer, 140 mm high
 - 1 drawer, 280 mm high
- Drawer bases protected by foamed rubber mats.
- Four castors 125 mm in Ø:
- 2 fixed and 2 steering (one with brake).
- Front centralized safety lock.
- Opening system throughout length of drawer.
- Static load capacity: 1200 kg.
- Thermoplastic worktop.
- Integrated side and rear bottle holders.
- Integrated paper roll holder.
- Uprights and drawer front made of aluminium.

1200 kg



C39-6/G



C39-6/R



C39-6/O

59 kg

h	max
70 mm	30 kg
140 mm	35 kg
280 mm	40 kg

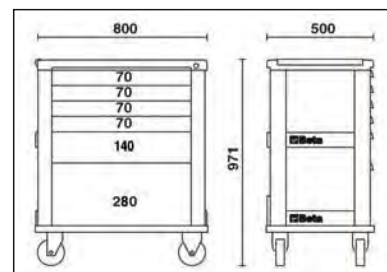
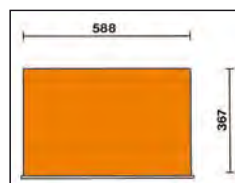

C39-6/O	1	039000031
C39-6/G	1	039000032
C39-6/R	1	039000033

C39T

portable tool chest with four drawers

Main features:

- Four drawers (588x367 mm) with ball bearing slides:
 - 4 drawers, 70 mm high
- Front centralized safety lock.
- Uprights and drawer front made of aluminium.



C39T-O



C39T-G



C39T-R



h	max
70 mm	30 kg

29 kg

C39T-O	1	039000101
C39T-G	1	039000102
C39T-R	1	039000103

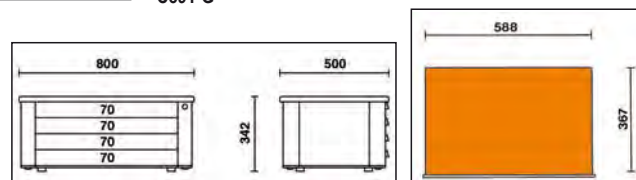

C39/7

roller cab
with seven drawers

Main features:

- Seven drawers (588x367 mm) with ball bearing slides:
 - 5 drawers, 70 mm high
 - 1 drawer, 140 mm high
 - 1 drawer, 210 mm high.
- Drawer bases protected by foamed rubber mats.
- Four castors 125 mm in Ø:
 - 2 fixed and 2 steering (1 with brake).
- Front centralized safety lock.
- Opening system throughout length of drawer.
- Static load capacity: 1000 kg.
- Thermoplastic worktop.
- Integrated side and rear bottle holders.
- Integrated paper roll holder.
- Uprights and drawer front made of aluminium.

61 kg

1200 kg



C39-7/O



C39-7/G



C39-7/R

h	max
70 mm	30 kg
140 mm	35 kg
210 mm	35 kg

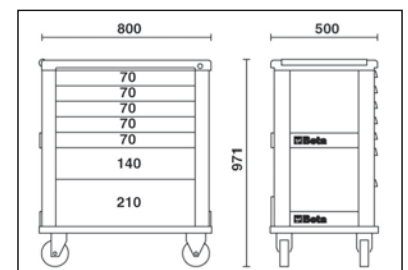
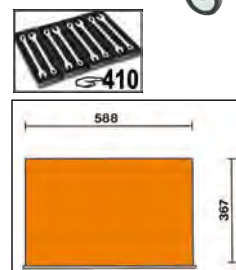

C39-7/O	1	039000001
C39-7/G	1	039000002
C39-7/R	1	039000003

C39/8

mobile roller cab with eight drawers

Main features:

- Eight drawers (588x367 mm) with ball bearing slides:
- 6 drawers, 70 mm high
- 2 drawers, 140 mm high
- Drawer bases protected by foamed rubber mats.
- Four castors 125 mm in Ø:
- 2 fixed and 2 steering (one with brake).
- Front centralized safety lock.
- Opening system throughout length of drawer.
- Static load capacity: 1200 kg.
- Thermoplastic worktop.
- Integrated side and rear bottle holders.
- Integrated paper roll holder.
- Uprights and drawer front made of aluminium.

64 kg

1200 kg



C39-8/O



C39-8/G



C39-8/R

h 	 max
70 mm	30 kg

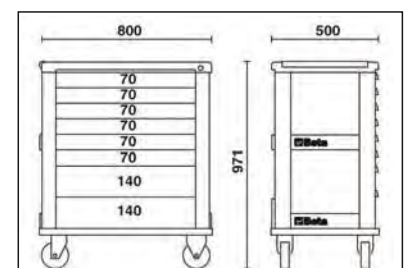
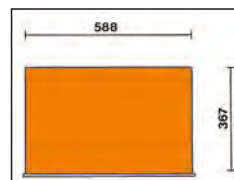

C39-8/O	1	039000041
C39-8/G	1	039000042
C39-8/R	1	039000043

2200-COVER C22S

Nylon cover for portable tool chest item C22S



2200-COVER C22S

1 022000910

2300-COVER C23S

Nylon cover for portable tool chest item C23S



2300-COVER C23S

1 023000920

2300-COVER C23ST

Nylon cover for portable tool chest item C23ST



2300-COVER C23ST

1 023000930

2400-COVER C24S

Nylon cover for mobile roller cabs items C24S/SA - C39



2400-COVER C24S

1 024000910

2400-COVER C24SA-XL

Nylon cover for mobile roller cab item C24SA-XL



2400-COVER C24SA-XL

1 024000930

3700-COVER C37

Nylon cover for mobile roller cab item C37



3700-COVER C37

1 037000930

4100-COVER C41H

Nylon cover for tool trolley item C41H



4100-COVER C41H

1 041000930

1 041000930

C39SM

special mobile roller cab, Racing SM type

Specifications

- Multi-ply wood worktop
- 4 castors, Ø 125 mm
- 2 fixed and 2 steering (one with brake), with exposed covering
- Static load capacity: 1200 kg

7-drawer module

- 588x367 mm, with ball bearing slides:
- 6 drawers, 70 mm high
- 1 drawer, 240 mm high
- Drawer bases protected by foamed rubber mats
- Front centralized safety lock
- Opening system throughout length of drawer
- Drawer front made of aluminium

Service module

- Integrated wastepaper basket
- Paper roll compartment
- 1 large drawer (420x305x270 mm)

125 kg

C39SM-O	1	039390001
C39SM-G	1	039390002
C39SM-R	1	039390003



h	max
70 mm	30 kg
240 mm	40 kg

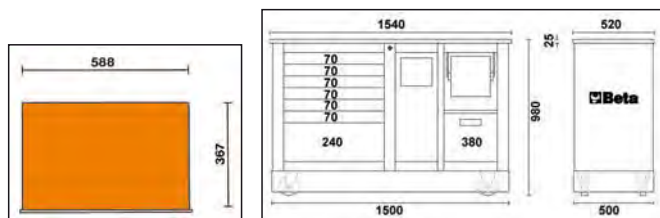

C39MD

special mobile roller cab, Racing MD type

Specifications

- Multi-ply wood worktop
- 4 castors, Ø 125 mm
- 2 fixed and 2 steering (one with brake), with exposed covering
- Static load capacity: 1200 kg

7-drawer module

- 588x367 mm, with ball bearing slides:
- 6 drawers, 70 mm high
- 1 drawer, 240 mm high
- Drawer bases protected by foamed rubber mats
- Front centralized safety lock
- Opening system throughout length of drawer
- Drawer front made of aluminium

2-drawer module

- 588x367x270 mm and 588x367x380 mm, with ball bearing slides
- Drawer bases protected by foamed rubber mats
- Front centralized lock
- Opening system throughout length of drawers
- Drawer front made of aluminium

123 kg

C39MD-O	1	039390101
C39MD-G	1	039390102
C39MD-R	1	039390103



h	max
70 mm	30 kg
240 mm	40 kg

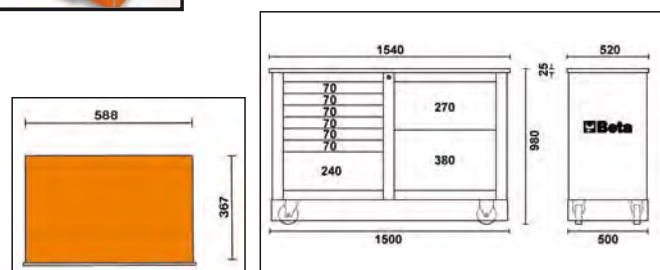

C41S

two-module tool trolley

Main features:

- Sheet metal frame and plastic tops, synonymous with remarkable sturdiness and reduced weight.
- 2 detachable modules:
 - 1 upper tool box,
 - 1 module with 2 drawers, 95 mm and 295 mm high respectively.
- Oversized castors (160 mm), built into frame for easy transport - for example, on steps.
- Side centralized lock for closing drawers of lower module.
- Drawers with ball bearing slides and double closing hook.
- Telescopic aluminium handle.
- Small tool holder built into upper tool box.
- Lower drawer with double ballbearing slide

Recommended assortments: 5940/SBK and 5915VU/5

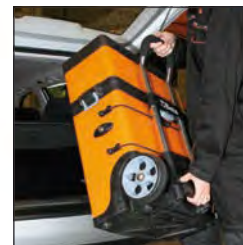

16 kg

C41S

1 041000001

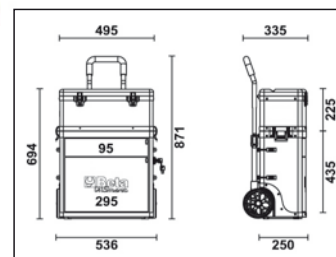
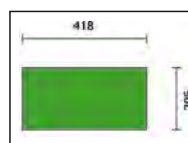

C41H

two-module tool trolley

Main features:

- Sheet metal frame and plastic tops, synonymous with remarkable sturdiness and reduced weight.
- 2 detachable modules:
 - 1 upper tool box,
 - 1 module with 2 drawers 95 mm in height,
 - 1 pull-out case made of plastic, 66 mm high, and 1 drawer 295 mm in height.
- Oversized castors (160 mm), built into frame for easy transport - for example, on steps.
- Side centralized lock for closing drawers of lower module.
- Drawers with ball bearing slides and double closing hook.
- Telescopic aluminium handle.
- Small tool holder built into upper tool box.
- Lower drawer with double ballbearing slide

Recommended assortments: 5941VU/M, 5940/SBK and 5915VU/5

* Colours available on request



C41H-O



21 kg

C41H-O	RAL 2011	1	041000002
C41H-N	RAL 9005	1	041000005
C41H-B	RAL 5002	1	041000006
C41H-R	RAL 3000	1	041000008
C41H-G	RAL 7016	1	041000010
C41H-Y	RAL 1023	1	041000012
C41H-W	RAL 9016	1	041000021
C41H-V	RAL 6016	1	041000024

C41H-W

C41H-Y

C41H-R

C41H-V

C41H-B

C41H-G

C41H-N

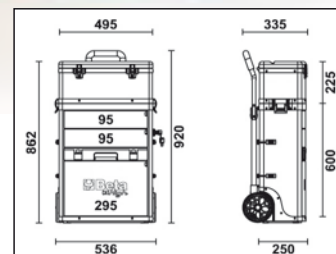
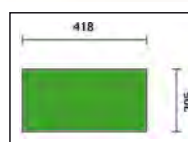

C41MS

upper module
with built-in small tool holder

3 kg

C41MS	RAL 2011	1	041000904
C41MS/N	RAL 9005	1	041000922
C41MS/B	RAL 5002	1	041000932
C41MS/R	RAL 3000	1	041000942
C41MS/G	RAL 7016	1	041000952
C41MS/Y	RAL 1023	1	041000962
C41MS/W	RAL 9016	1	041000972
C41MS/V	RAL 6016	1	041000982



495x250x225 mm

C41H/CE

tool chest
with removable partitions for small tools,
made from plastic material

1,3 kg

C41H/CE	1	041000916
---------	---	-----------



C42H

three-module tool trolley

Main features:

- Sheet metal frame and plastic tops, synonymous with remarkable sturdiness and reduced weight.
- 3 detachable modules:
 - 1 upper tool box, 220 mm high
 - 1 central tool module, 180 mm high.
 - 1 lower tool module with castors, 330 mm high.
- Oversized castors (ø 160 mm).
- Telescopic handle, can be adjusted in 3 positions
- Quick module release system: easy, quick access to all tool compartments.
- Upper tool box with interior object compartment and 3 tool trays built into cover.
- Can be used with 2 modules.

Recommended assortments: 5940/SBK and 5915VU/5

14 kg

C42H	1	042000002
------	---	-----------

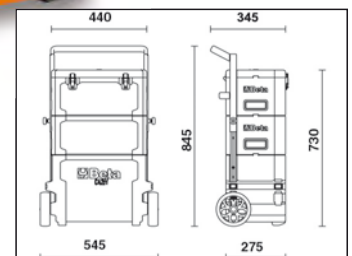

C42 MCH

additional central module for tool trolley item C42

2,5 kg

C42MCH	1	042000105
--------	---	-----------



440x180x275 mm

C43

three-module tool trolley

Main features:

- Sheet metal frames and plastic tops
- 3 detachable modules:
 - 1 upper tool box, 222 mm high
 - 1 central module, 168 mm high, with 2 drawers, 60 mm high
 - 1 lower module, 332 mm high, with up-and-over door, 280 mm high, with castors
- Castors \varnothing 128 mm
- Telescopic handle, can be adjusted in 4 positions
- Module release system with access to all tool compartments
- Upper tool box with removable interior object compartment and 2 tote-trays built into cover

15,5 kg

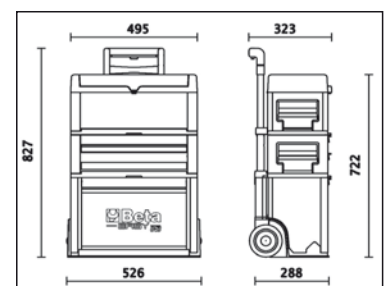
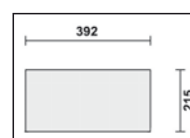

CX49-G

multi-purpose trolley

can be used as a mobile workstation for diagnostic tools, laptops, testers and battery chargers.

SPECIFICATIONS

- Painted sheet metal frame: unparalleled firmness and sturdiness
- Ergonomic handle
- 2-level top
- Pull-out drawer for housing a mini keyboard
- 2 central shelves with adjustable position and 1 fixed low shelf
- 4 useful side cable reels made of plastic - 2 useful side containers
- 2 fixed rear castors Ø 160 mm
- 2 steering front castors Ø 100 mm (one with brake)
- Weight: 36 kg



CX49



1 049000102

CA49-G

multi-purpose trolley with door

can be used as a mobile workstation for diagnostic tools, laptops, testers and battery chargers.

SPECIFICATIONS

- Painted sheet metal frame: unparalleled firmness and sturdiness
- Ergonomic handle
- 2-level top
- Pull-out drawer for housing a mini keyboard
- 1 shelf with adjustable position, 1 fixed shelf and door
- 4 useful side cable reels made of plastic
- 2 useful side containers
- 2 fixed rear castors Ø 160 mm
- 2 steering front castors Ø 100 mm (one with frame)
- Weight: 36.5 kg



CA49 G



1 049000112

4900-COVER C49

nylon cover for multi-purpose tool trolley item C49



4900-COVER C49



1 049000930

C51 trolley

- 3 tops covered in antislip ribbed rubber
- Ergonomic handle
- Two fixing options for central worktop
- Four castors Ø 100 mm:
2 fixed and 2 steering (1 with brake)
- Static load capacity: 200 kg (distributed between 3 shelves)

21 kg

C51 O	1	051000001
C51 G	1	051000002
C51 R	1	051000003

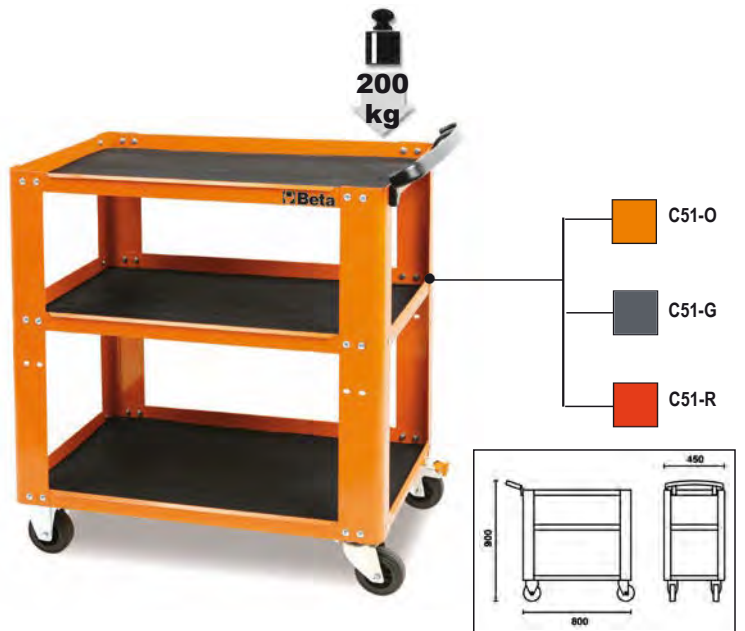

C50S

service tool trolley with 3 drawers

Main features:

- Thermoplastic worktop
- 3 drawers (588x367 mm) with ball bearing slides, 70 mm high
- Drawer bases protected by foamed rubber mats
- Front centralized safety lock
- Convenient side screwdriver holder included
- Two side built-in spray can holders
- Large lower shelf protected by an anti-oil and anti-rubber mat
- Four castors, Ø 125 mm:
2 fixed and 2 steering (one with brake)
- Static load capacity: 400 kg
- Capacity of each drawer: 15 kg, uniformly distributed
- Paper roll holder item 2400S-R/PC can be applied on request
- Folding shelf item 5000MS can be applied on request

38 kg

C50S-O	1	050000301
C50S-G	1	050000302
C50S-R	1	050000303



5000MS

folding shelf for tool trolley item C50S

- For use as additional worktop
- Worktop dimensions: 425x378 mm, protected by an anti-oil and anti-petrol rubber mat
- Load capacity: 20 kg.

3,4 kg

5000MS	1	050000901
--------	---	-----------

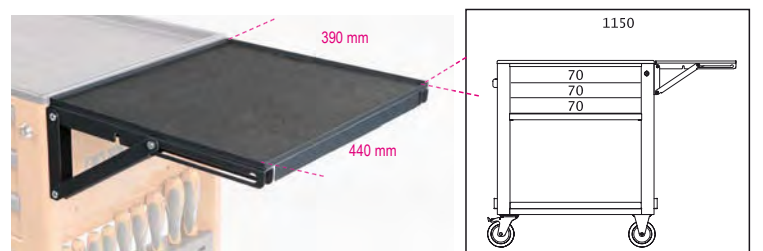

CP51

high-grade trolley

- 2 tops covered with rubber mats
- Ergonomic handle
- Four high-grade castors Ø 125 mm:
2 fixed and 2 steering with brake
- Static load capacity: 750 kg (shared by 2 tops)

📦 37 kg

CP51 O	1	051000501
CP51 G	1	051000502
CP51 R	1	051000503

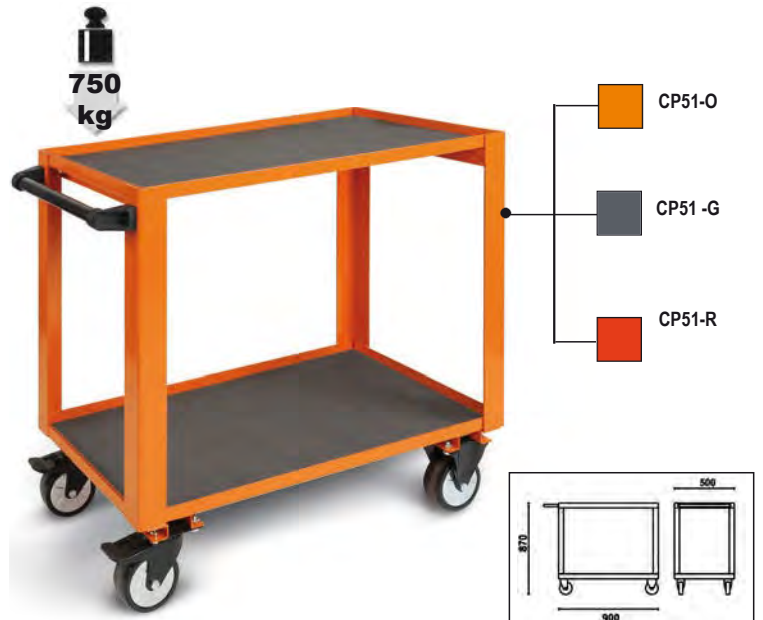

CB52

gearbox/transmission trolley
with liquid recovery system

Inclined plane and drain holes
allow liquids to be recovered in collection tank

Fitted with:

- 4 swivel castors, including 2 with brakes
- tool drawer
- pull-out liquid collection tank; capacity: 7 l
- 2 shelves

Dimensions: 1200x640x870 mm

Weight: 60 kg

📦 60 kg

CB52	1	052000201
------	---	-----------



C56P O

folding workbench

Compact and easy to carry.
Worktop (800x500mm, 30 mm thick) made of MDF and galvanized sheet iron, for use on both sides.
Handle with rubber cover, for easy transportation.
Feet with nonslip cover.
Static load capacity: 250 kg

📦 25 kg

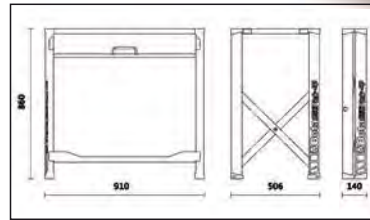

C56P O



C56PL O

folding workbench, Light version

Lightweight, compact, easy to carry.
Worktop (800x500mm) made galvanized sheet iron, for use on one side, protected by an anti-oil and anti-petrol rubber cover.
Handle with rubber cover, for easy transportation.
Feet with nonslip cover.
Static load capacity: 200 kg

📦 18,5 kg

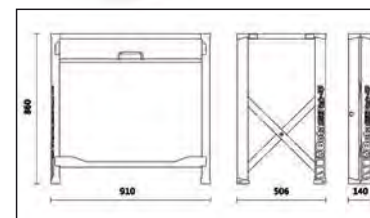

C56PL O



C54S

Cargo tool cabinets

These tool cabinets are designed according to detailed research and offer accurate, comfortable and rational solutions for end users.

Two perforated panels attached to the doors may be opened giving access to additional storage space.

Main features:

- 1 drawer, with slides.
- Easy tool layout according to users' needs.
- Easy wall mounting by means of two slots located at the back of the cabinet .
- Safety lock for both drawers and doors.
- Empty thermoformed tray for 1/2" sockets and accessories



C54S-G



C54S-R



C54S-O

37 kg

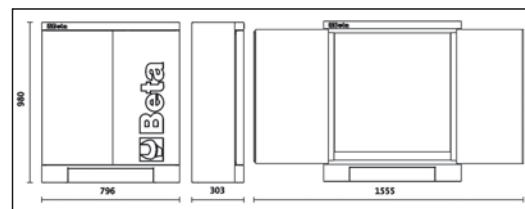

C54S-O	1	054000301
C54S-G	1	054000302
C54S-R	1	054000303

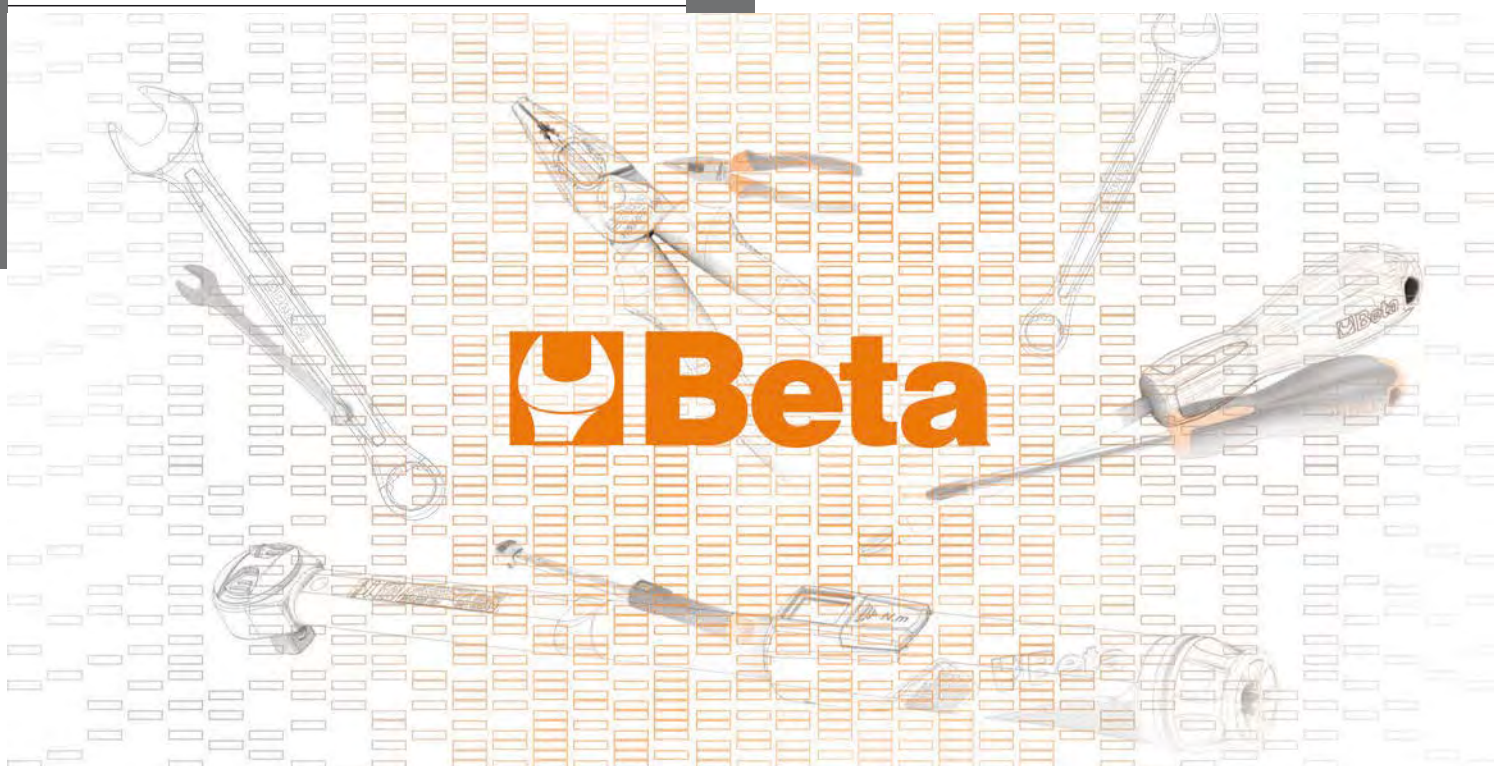

C57SA

MasterCargo workbench

- Model with tool storage board (C57P) and one drawer cabinet.

Drawer cabinet: five drawers, 588x367 mm, 3 90 mm high, 1 180 mm and 1 280 mm high, with ball bearing slides. Can accommodate thermoformed trays. Centralized lock.

Panel tool holder with holes on back for wall mounting. Vertically operated aluminium shutter, with lock. Three removable perforated panels for supporting tools.

Multi-ply worktop, coated in plastic laminate with three holes for vice item 1599F/150, to be ordered separately.



C57S A O

205 kg



C57S A G



C57S A R



5700S A O

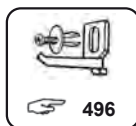

h	max
90 mm	30 kg
180 mm	40 kg
280 mm	40 kg

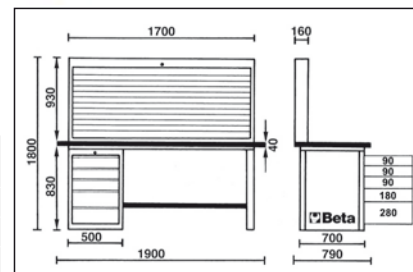

C57S/A-O	1	057001005
C57S/A-G	1	057001205
C57S/A-R	1	057001405

C57SD

MasterCargo workbench

- Model with one drawer cabinet

Drawer cabinet: five drawers, 588x367 mm, 3 90 mm high, 1 180 mm and 1 280 mm high, with ball bearing slides. Can accommodate thermoformed trays. Centralized lock.

Multi-ply worktop, coated in plastic laminate with three holes for vice item 1599F/150, to be ordered separately.



C57S D O



h	max
90 mm	30 kg
180 mm	40 kg
280 mm	40 kg



C57S D G



C57S D R

158 kg

C57S/D-O	1	057001004
C57S/D-G	1	057001204
C57S/D-R	1	057001404

C57SB

MasterCargo workbench

- Model with tool storage board (C57P) and two drawer cabinets.

Drawer cabinet: five drawers, 588x367 mm, 3 90 mm high 1 180 mm and 1 280 mm high, with ball bearing slides. Can accommodate thermoformed trays Centralized lock.

Panel tool holder with holes on back for wall mounting. Vertically operated aluminium shutter, with lock. Three removable perforated panels for supporting tools.

Multi-ply wood worktop, coated in plastic laminate with three holes for vice item 1599F/150, to be ordered separately.



C57S B O

243 kg



C57S B G



C57S B R



5700S B O



h	max
90 mm	30 kg
180 mm	40 kg
280 mm	40 kg

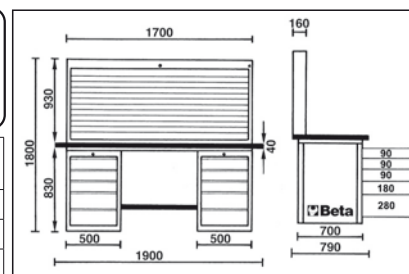

C57S/B-O	1	057001006
C57S/B-G	1	057001206
C57S/B-R	1	057001406

C57SC

MasterCargo workbench

- Model with two drawer cabinets.

Drawer cabinet: five drawers, 588x367 mm, 3 90 mm high 1 180 mm and 1 280 mm high, with ball bearing slides. Can accommodate thermoformed trays. Centralized lock.

Multi-ply wood worktop, coated in plastic laminate with three holes for vice item 1599F/150, to be ordered separately.



C57SC O



h	max
90 mm	30 kg
180 mm	40 kg
280 mm	40 kg



C57SC G



C57SC R

C57S/C-O	1	057001003
C57S/C-G	1	057001203
C57S/C-R	1	057001403

C57SP

panel tool holder

Panel tool holder with two holes on back for wall mounting.
Aluminium shutter, vertically adjustable, with lock.
Three removable perforated panels for tool holding.

46 kg

C57SP-O	1	057001020
C57SP-G	1	057001220
C57SP-R	1	057001420



C57SP O

1700 mm

930 mm

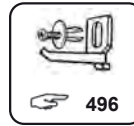

496



C57SP G



C57SP R

5700LAMP

MasterCargo workbench lamp

- Sturdy sheet metal frame comprising four elements; provided with screws for assembling the lamp.
- Lamp holder with 1120-Lumen LED strip, 4000K, 14W.
- Power supply 230V.
- Provided without wire.

9 kg

5700 LAMP	1	057000005
-----------	---	-----------



5700LAMP + 5700SA O

C58P

panel toolholder

- Security locked shutter.
- Two removable perforated panels for tool holding.

31 kg

C58P-O	1	058000121
C58P-G	1	058000122
C58P-R	1	058000123



C58P G



C58P R



496



C58P O

1200 mm

930 mm

PV

wall tool panel

	LxA mm	kg		
PV1	1000x920	10,2	1	088880010
PV1,5	1500x920	14,2	1	088880015



496

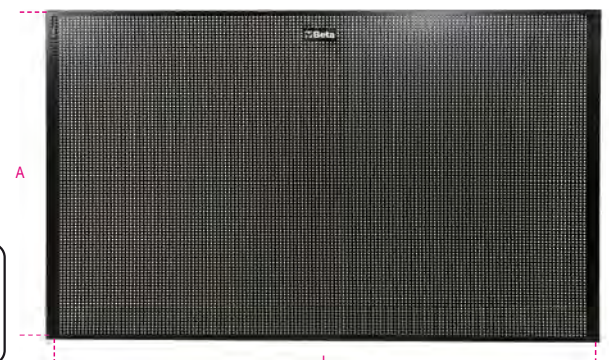

C56W

workbench with wood top

- Multi-ply wood worktop with holes for a vice (1599F/125, to be ordered separately).
- Steel frame with 6 supporting legs
- Static load capacity: 1,200 kg
- Matches panel tool holder C57P; cannot be fixed to worktop.
- Two drawers with locks.
- Can be fixed to floor.

86 kg



C56W-O	1	056000251
C56W-G	1	056000252
C56W-R	1	056000253

C56B

workbench with wood top

Main features:

- Multi-ply wood worktop with holes for a vice (1599F/125, to be ordered separately).
- Steel frame with 4 supporting legs.
- Static load capacity: 800 kg.
- Lower object shelf.
- Can be fixed to floor.

54,5 kg



C56B-O	1	056000401
C56B-G	1	056000402
C56B-R	1	056000403

C56

workbench

- Worktop made of painted sheet metal with external edge
- Steel frame with 6 supporting legs
- Static load capacity: 1200 kg
- Matches panel toolholder C57P; cannot be fixed to worktop
- Two drawers with lock
- Can be fixed to floor

82 kg



C56-O	1	056000201
C56-G	1	056000202
C56-R	1	056000203

C56M

workbench

- Worktop made from both slip-proof aluminium sheet and rubber mat.
- Load capacity: kg.800.
- Can match panel toolholder C57P.
- Three drawers with lock.
- Can be fixed to the floor.



800 kg

C56M O	1	056000050
C56M G	1	056000053
C56M R	1	056000054

C58B

workbench with wood top

Main features:

- Multi-ply wood worktop with holes for a vice (1599F/125, to be ordered separately).
- Steel frame with 4 supporting legs.
- Static load capacity: 800 kg.
- Lower object shelf.
- Can be fixed to floor.

800 kg



C58B-O	1	058000401
C58B-G	1	058000402
C58B-R	1	058000403

C58M

workbench

- Metal worktop fully covered with a removable antislip rubber mat.
- Lower shelf made from solid wood.
- Static load capacity: 800 kg.
- Can match panel tool holder C58P; cannot be fixed to the worktop.
- 2 drawers with locks.
- Can be fixed to the floor.
- Aluminium worktop item C58M/PA available on request.

800 kg



C58M-O	1	058000300
C58M-G	1	058000302
C58M-R	1	058000303

C58M/PA

knurled aluminium worktop
for workbench item C58M

4,5 kg



C58M/PA



058000350

C59A

"Endurance" workbench with 1 cab with six drawers

Main features:

- Worktop made from multi-ply wood with holes for vice item 1599F/125 (to be ordered separately).
- 6 drawers (588x367 mm) with ball bearing slides:
4 drawers, 70 mm high
1 drawer, 140 mm high
1 drawer, 280 mm high.
- Drawers protected by foamed rubber mats.
- Hard-wearing nylon drawer front.
- Roller cabs can accommodate thermoformed trays.
- Front centralized safety lock.
- Lower object shelf.
- Can be fitted with paper roll holder (2400S-R/PC) and bottle holder (2400S/PF), to be ordered separately.

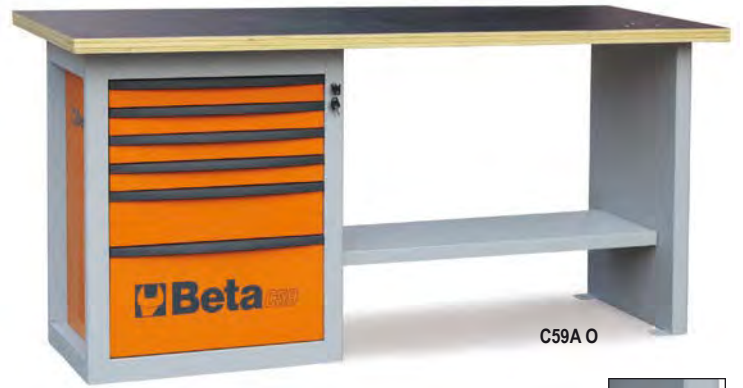

115 kg

1500 kg



h	max
70 mm	25 kg
140 mm	30 kg
280 mm	35 kg

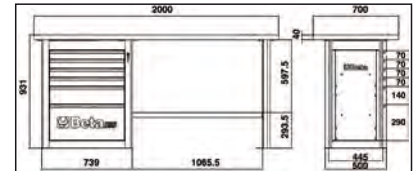

C59A-O	1	059000001
C59A-G	1	059000021
C59A-R	1	059000041

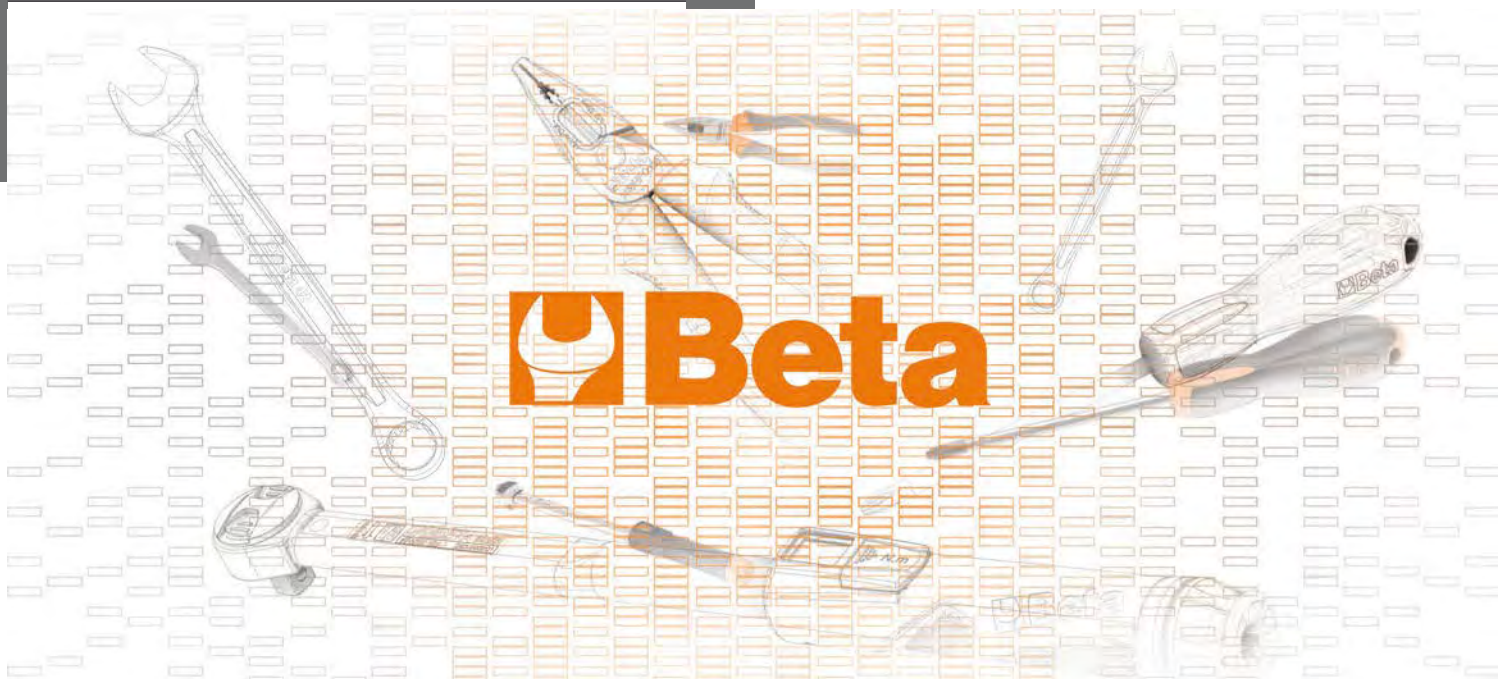

C59B

"Endurance" workbench with 2 cabs with six drawers

Main features:

- Worktop made from multi-ply wood with holes for vice item 1599F/125 (to be ordered separately).
- 12 drawers (588x367 mm) with ball bearing slides:
 - 8 drawers, 70 mm high
 - 2 drawers, 140 mm high
 - 2 drawers, 280 mm high.
- Drawers protected by foamed rubber mats.
- Can accommodate thermoformed trays.
- Front centralized safety lock.
- Lower object shelf.
- Can be fitted with paper roll holder (2400S-R/PC) and bottle holder (2400S/PF), to be ordered separately.

155 kg

		
C59B-O	1	059000002
C59B-G	1	059000022
C59B-R	1	059000042





C59B O



C59B G



C59B R

h		 max
70 mm		25 kg
140 mm		30 kg
280 mm		35 kg

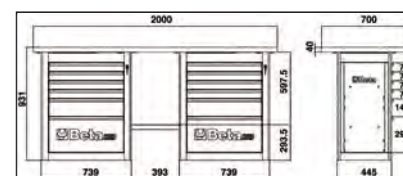

C59C

"Endurance" workbench with 1 cab with six drawers, short model

Main features:

- Worktop made from multi-ply wood with holes for vice item 1599F/125 (to be ordered separately).
- 6 drawers (588x367 mm) with ball bearing slides:
 - 4 drawers, 70 mm high
 - 1 drawer, 140 mm high
 - 1 drawer, 280 mm high.
- Drawers protected by foamed rubber mats.
- Can accommodate thermoformed trays.
- Front centralized safety lock.
- Lower object shelf.
- Can be fitted with paper roller holder (2400S-R/PC) and bottle holder (2400S/PF), to be ordered separately.

105 kg

		
C59C-O	1	059000003
C59C-G	1	059000023
C59C-R	1	059000043



C59C G





C59C R



C59C O



h		 max
70 mm		25 kg
140 mm		30 kg
280 mm		35 kg

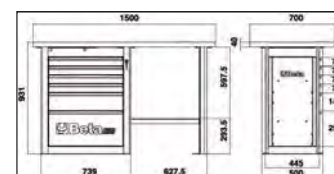

9562T2

workbench mat, 200x160 cm

- protects floor from oil and petrol leaks, environmentally friendly
- easy to clean, anti-skid, rubber-coated bottom



9562T2

  095620200



WORKSHOP EQUIPMENT



To answer the requirements of a market where the emphasis is increasingly on quality, design and customization, Beta Utensili has developed "Racing System C55", modular garage furniture shaped on your needs, while allowing you to create a modern work environment.

Quality

Beta's best Italian-made quality to furnish your garage

Organization

A sensibly organized workstation, synonymous with optimized work

Modularity

Modular garage fitting your spaces and requirements



Design

Refined, captivating finishes for a tidy, attractive workstation





MADE IN ITALY

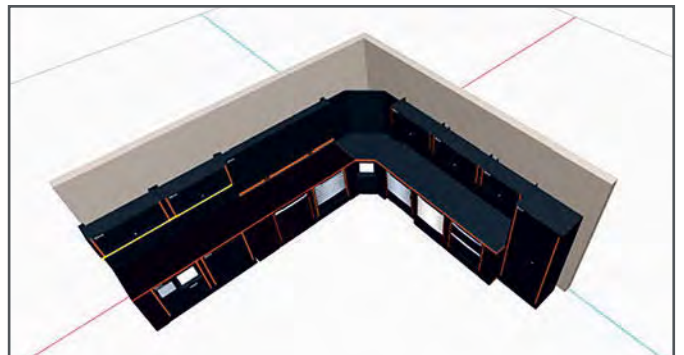

Configure your workshop online
Go to **www.rsc55.com**



Your colours for your workshop!

RSC55 allows you to order the benches and tool wall system with shutter in a neutral (grey) version and customize the vertical coloured inserts by choosing from 7 different adhesive tapes.

1. Order the vertical insert in a neutral colour

2. Order the vertical insert

Choose the colour to your taste or according to your company's colours

C55

comprehensive workshop equipment combination RSC55

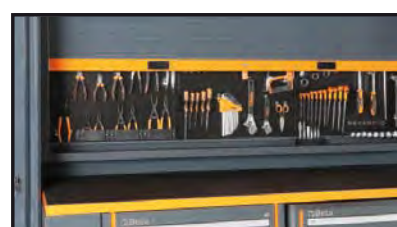

Comprehensive combination comprising:

- Single-door tool cabinet (C55A1)
- Two-door tool cabinet (C55A2)
- Workbench (C55BO/2)
- Workbench with sockets (C55PRO BO/2)
- Mobile roller cab with 7 drawers (C55C7)
- Fixed module with 2 storage drawers (C55M2)
- Fixed module with 7 drawers (C55M7)
- Fixed service module (C55MS)
- Tool panel with suspended cabinets (C55/2PM)
- Tool panel with shutter (C55PS-O)

C55AB

workshop equipment combination

Combination comprising:

- Two-door tool cabinet (C55A2)
- Workbench (C55BO/2)
- Fixed module with 7 drawers (C55M7)
- Fixed service module (C55MS)
- Tool panel with suspended cabinets (C55/2PM)

407 kg



C55AB

1 055000020



C55PB/3

workshop equipment combination

Combination comprising:

- Workbench (C55BO/2)
- Roller cab module with 8 drawers (C55C8)
- Fixed module with 2 storage drawers (C55M2)
- Wall tool system with shutter (C55PS-O)

334 kg



C55PB/3

1 055000035



C55B/2

2-m-long workbench, for workshop equipment combination

With worktop (2050x700 mm) covered with a shockproof, non-scratch PVC coat, resistant to hydrocarbons

- Holes for a vice (1599F/150, to be ordered separately)
- Vertically adjustable feet

105 kg

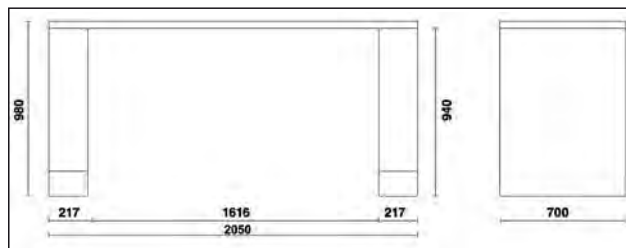
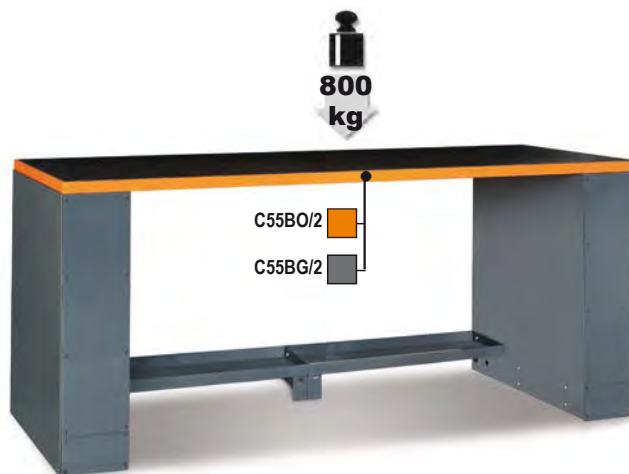

C55BO/2	1	055000101
C55BG/2	1	055000111

C55PRO B/2

2-m-long workbench, for workshop equipment combination

With worktop (2050x700 mm) covered with a shockproof, non-scratch PVC coat, resistant to hydrocarbons

Built-in sockets and roller:

- Schuko socket+16+10A
- Plug +10A
- Compressed air outlet and roller, Ø 8 mm. Length: 10 m
- Holes for a vice (1599F/150, to be ordered separately)
- Vertically adjustable feet

110 kg

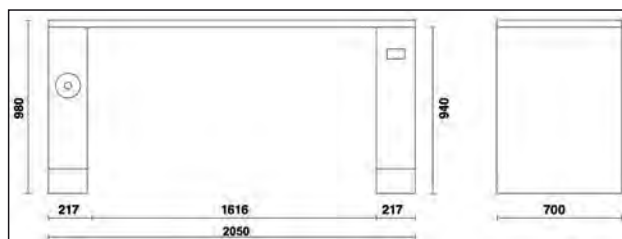
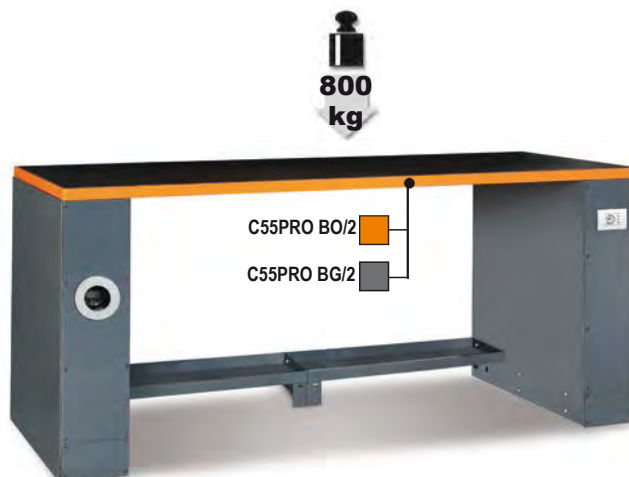

C55PRO BO/2	1	055000151
C55PRO BG/2	1	055000171

C55B/2,8

2.8-m-long workbench, for workshop equipment combination

Worktop (2850x700 mm) covered with a shockproof, non-scratch PVC coat, resistant to hydrocarbons

- Holes for a vice (1599F/150, to be ordered separately)
- Vertically adjustable feet

129 kg

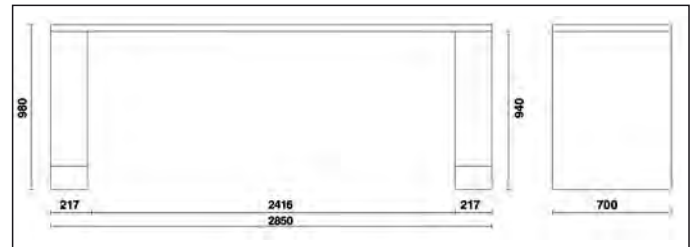
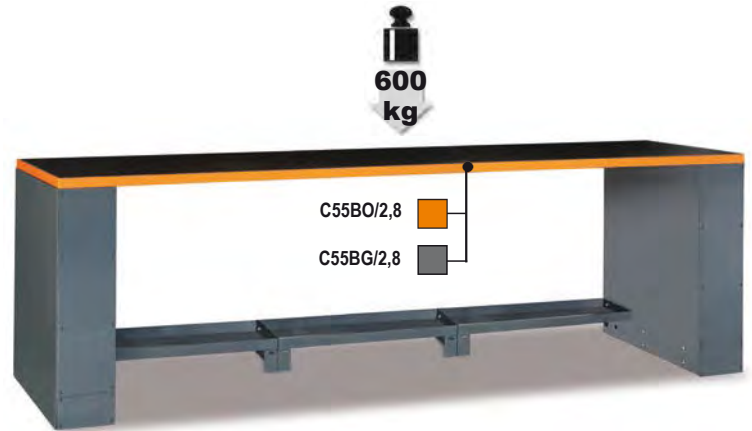

C55BO/2,8	1	055000261
C55BG/2,8	1	055000281

C55PRO B/2,8

2.8-m-long workbench, for workshop equipment combination

Worktop (2850x700) covered with a shockproof, non-scratch PVC-coat, resistant to hydrocarbons

Built-in sockets and roller:

- Schuko socket+16+10A
- Plug +10A
- Compressed air outlet and roller Ø 8 mm. Length: 10 m
- Holes for a vice (1599F/150, to be ordered separately)
- Vertically adjustable feet

134 kg

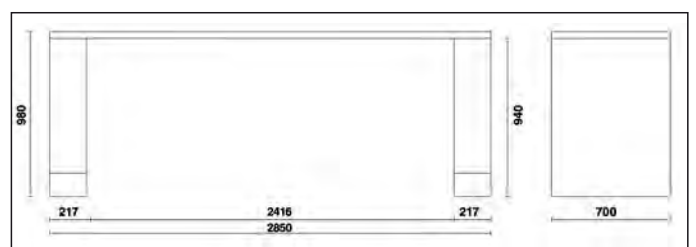
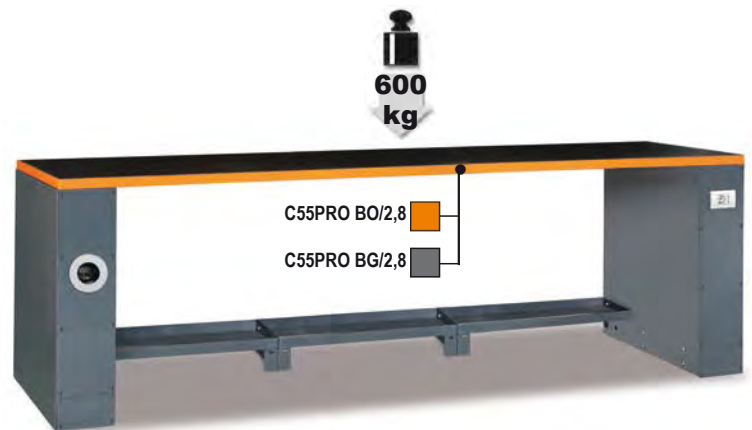

C55PRO BO/2,8	1	055000271
C55PRO BG/2,8	1	055000283

C55B-D4

double 4-m-long workbench with central leg

Worktop (4100x700 mm) covered with a shockproof, non-scratch PVC coat, resistant to hydrocarbons

- Holes for a vice 1599F/150 (to be ordered separately)
- Vertically adjustable feet
- Double central leg with compartment and slide-away door, 350x750 mm

185 kg

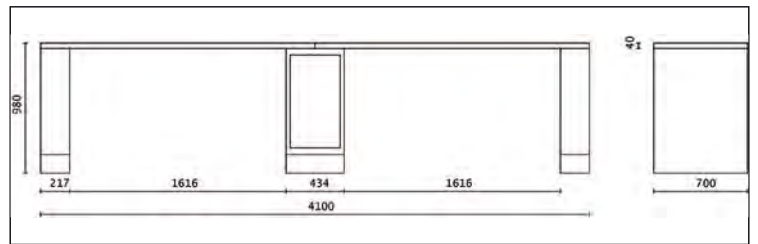
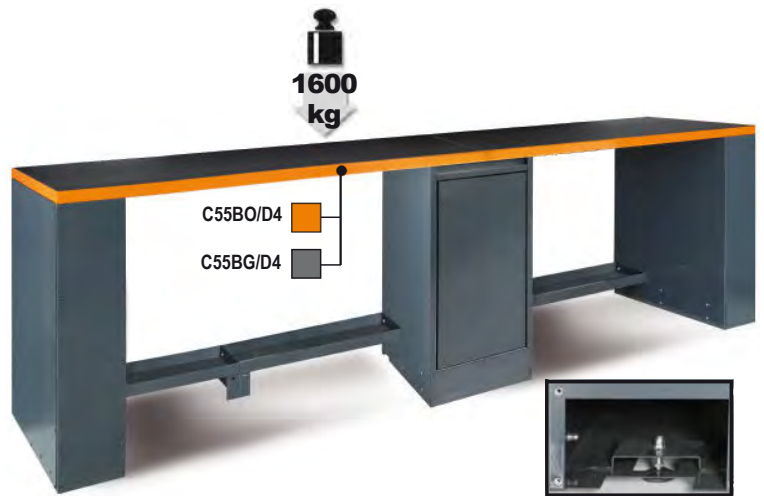

C55BO-D4	1	055000109
C55BG-D4	1	055000119

C55PRO B-D4

double 4-m-long workbench with central leg

With worktop (4100x700) covered with a shockproof, non-scratch PVC coat, resistant to hydrocarbons

Built-in sockets and reel:

- Schuko socket+16+10A
- EU Plug +10A
- Compressed air outlet with reel Ø 8 mm. Length: 10 m
- Holes for a vice 1599F/150 (to be ordered separately)
- Vertically adjustable feet
- Double central leg with compartment and slide-away door, 350x700 mm

190 kg

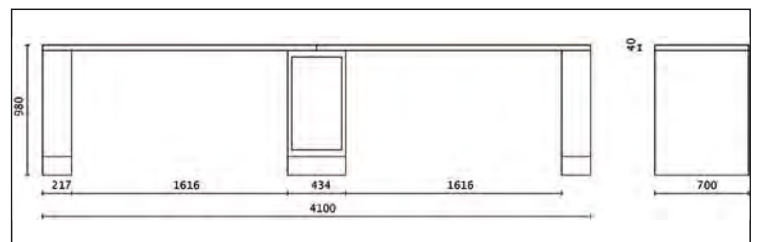
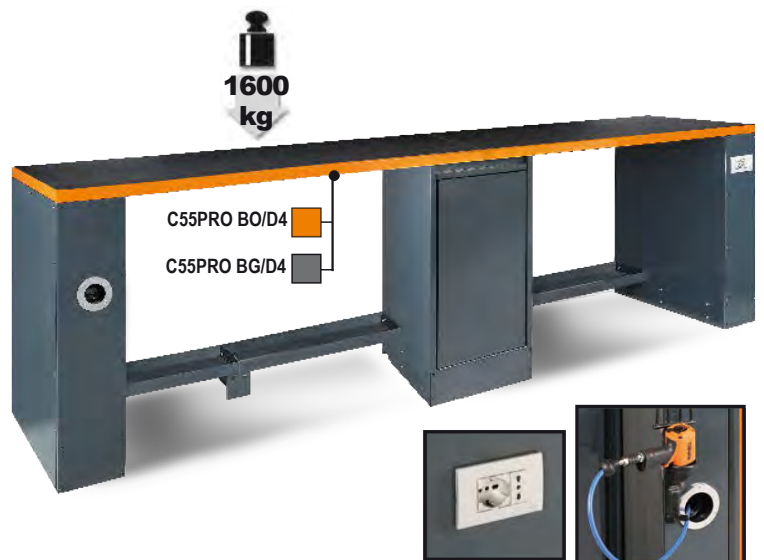

C55PRO-BO-D4	1	055000159
C55PRO-BG-D4	1	055000179

Beta

C55B/G

universal leg for workshop equipment workbench

- With vertically adjustable feet

30 kg

C55B/G

1 055000096

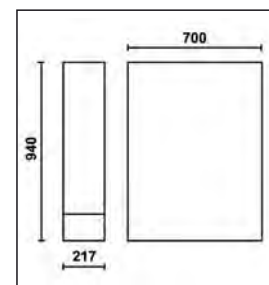

C55B/GAA

universal leg for workbench with built-in hose reel

- Built-in automatic hose reel for compressed air or cold water (Ø 8 mm) item 1901BM/8
- Length: 10 m
- With vertically adjustable feet

35 kg

C55B/GAA

1 055000099

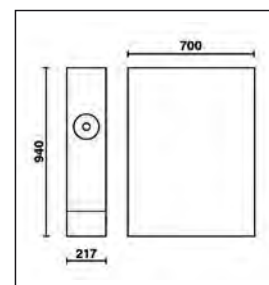
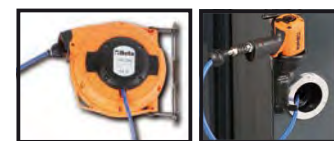

C55B/GDP

double leg for adjoining workshop equipment workbenches

- Paper roll holder compartment
- Compartment with door
- With vertically adjustable feet

45 kg

C55B/GDP

1 055000292

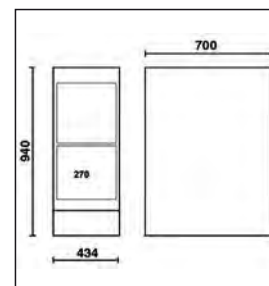

C55B/GDS

double leg for adjoining workshop equipment workbenches

- Compartment with slide-away door, 365x750 mm
- With vertically adjustable feet

45 kg

C55B/GDS

1 055000291

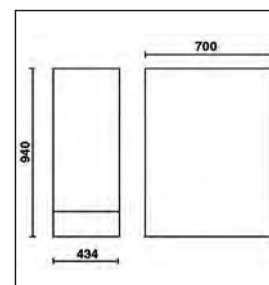

C55B/GE

universal leg with power sockets for workshop equipment workbench

- Schuko socket+16+10A
- EU Plug +10A
- With vertically adjustable feet

30 kg

C55B/GE

1 055000097

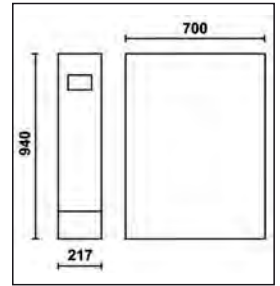

C55B/GAE

universal leg with built-in electrical cable reel for workshop equipment workbench

- Built-in automatic cable reel with Schuko type socket item 1848.
- Length: 15 m
- Thermally protected
- With vertically adjustable feet

35 kg

C55B/GAE

1 055000094

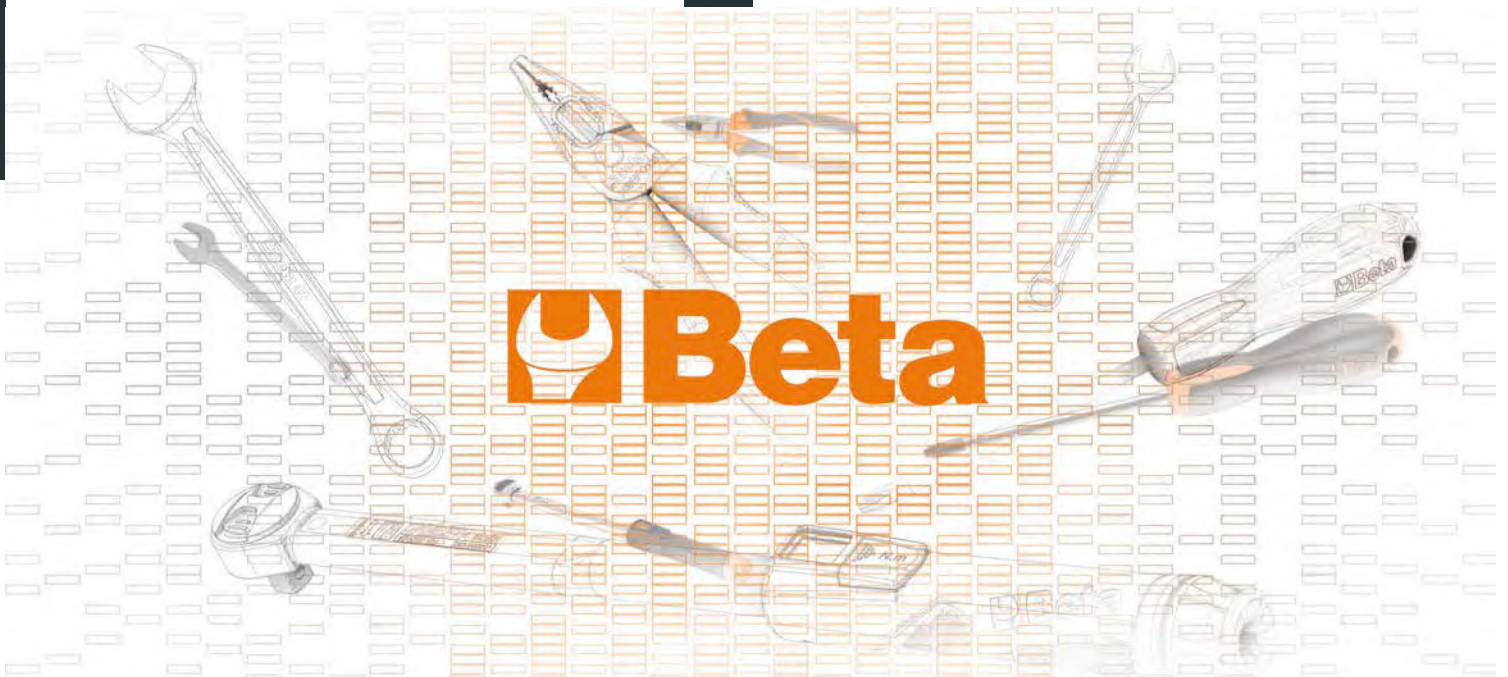
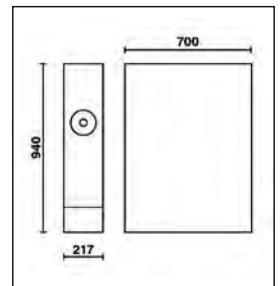

C55/PL-1,024

worktop for workshop equipment workbench, 1 m long

- Painted sheet metal worktop (1024x700 mm) covered with a shockproof, non-scratch PVC coat, resistant to hydrocarbons
- With rear crossbar for fixing modules

21 kg

C55/PLO-1,024	1	055000130
C55/PLG-1,024	1	055000131



C55B PT/2

2-m-long worktop, for workshop equipment workbench

Painted sheet metal worktop (2050x700 mm) covered with a shockproof, non-scratch PVC coat, resistant to hydrocarbons
With rear crossbar for fixing modules
Holes for a vice (1599F/150, to be ordered separately)

43 kg

C55B PT/2	1	055000106
C55BG PT/2	1	055000116



C55B PT/2,8

2.8-m-long worktop, for workshop equipment workbench

Painted sheet metal worktop (2850x700 mm) covered with a shockproof, non-scratch PVC coat, resistant to hydrocarbons
With rear crossbar for fixing modules
Holes for a vice (1599F/150, to be ordered separately)

61 kg

C55BO PT/2,8	1	055000266
C55BG PT/2,8	1	055000286



C55RB

shockproof, non-scratch PVC coat, resistant to hydrocarbons

For protecting worktop.

C55RB/2: for 2-m-long worktop

C55RB/2.8: for 2.8-m-long worktop

C55RB/0.7: for 700x700mm worktop

C55RB/1: for 1-m-long worktop

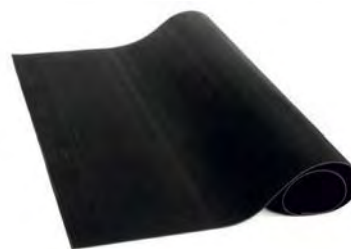

C55RB/2	1	055000195
C55RB/2,8	1	055000196
C55RB/0,7	1	055000199
C55RB/1	1	055000198

C55B/VS

lower workbench bracket, 0.8 m long

Dimensions: 800x230x60 mm

4 kg

C55B/VS	1	055000095
---------	---	-----------

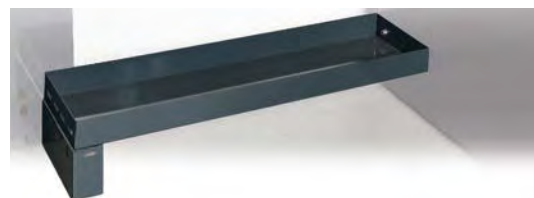

C55C7

mobile roller cab with seven drawers, for workshop equipment combination

7 drawers (588x367 mm), with ball bearing slides

- 4 castors Ø 100 mm, 2 fixed (one with brake) and 2 steering
- Aluminium opening system throughout length of drawer
- Drawer bases protected by foamed rubber mats
- Front centralized lock
- Can be fitted with foam trays

79 kg



h	max
70 mm	30 kg
245 mm	40 kg

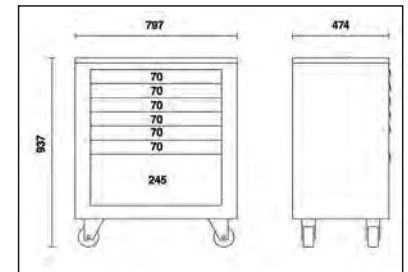
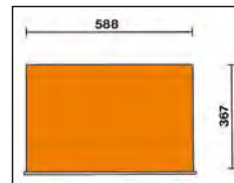

C55C7

1 055000201

Beta

C55C8

roller cab module with eight drawers, for workshop equipment combination

8 drawers(588x367 mm) with ball bearing slides

- 4 castors Ø 100 mm, 2 fixed (one with brake) and 2 steering
- Aluminium opening system throughout length of drawer
- Drawer bases protected by foamed rubber mats
- Front centralized lock
- Can be fitted with foam trays

81 kg



h	max
70 mm	30 kg
175 mm	40 kg

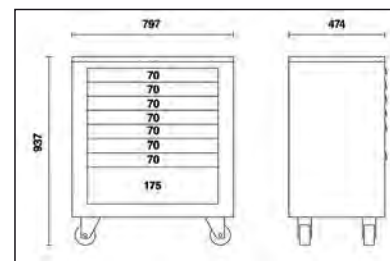
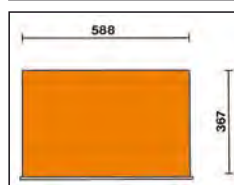

C55C8

1 055000206

C55M2

fixed module with 2 drawers, for workshop equipment combination

2 drawers (588x367mm) with ball bearing slides

- Aluminium opening system throughout length of drawer
- Drawer bases protected by foamed rubber mats
- Front centralized lock

66 kg



h	max
280 mm	40 kg
385 mm	40 kg

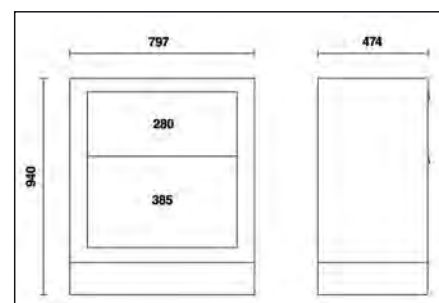
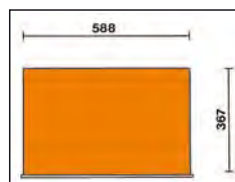

C55 M2

1 055000202

C55M4

fixed module with 4 drawers, for workshop equipment combination

4 drawers (588x367 mm) with ball bearing slides

- Aluminium opening system throughout length of drawer
- Drawer bases protected by foamed rubber mats
- Front centralized lock

75 kg



h	max
140 mm	30 kg
245 mm	40 kg

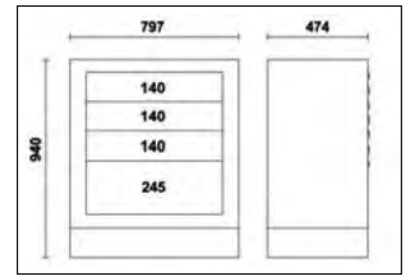
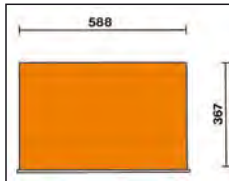

C55M4

1 055000212

C55M7

fixed module with seven drawers, for workshop equipment combination

7 drawers (588x367 mm) with ball bearing slides

- Aluminium opening system throughout length of drawer
- Drawer bases protected by foamed rubber mats
- Front centralized lock
- Can be fitted with foam trays

78 kg



h	max
70 mm	30 kg
245 mm	40 kg

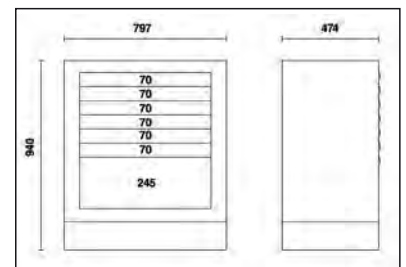
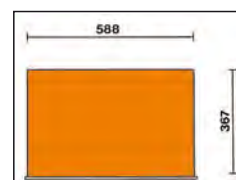

C55M7

1 055000203

C55M8

fixed module with 8 drawers for workshop equipment combination

- 8 drawers (588x367 mm) with ball bearing slides
- Aluminium opening system throughout length of drawer
- Drawer bases protected by foamed rubber mats
- Front centralized lock
- Can be fitted with foam trays

78,9 kg



h	max
70 mm	30 kg
175 mm	40 kg

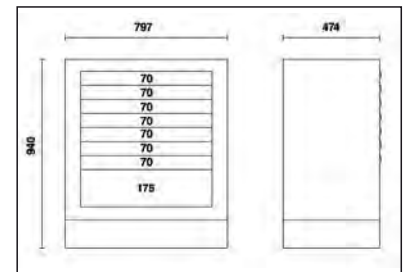
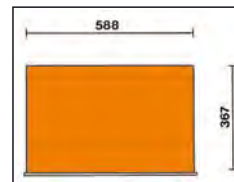

C55M8

055000207

C55CS

fixed sorted waste collection module for workshop equipment combination

- Pull-out waste compartment (588x465) with ball bearing slides
- 2 capacious pull-out interior containers for sorting waste

62 kg

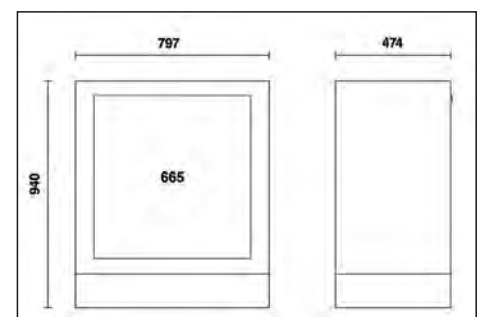

C55SC

055000208

C55MA

fixed two-door module, for workshop equipment combination

- Push Pull opening
- With lock• Interior shelf, vertically adjustable

75 kg

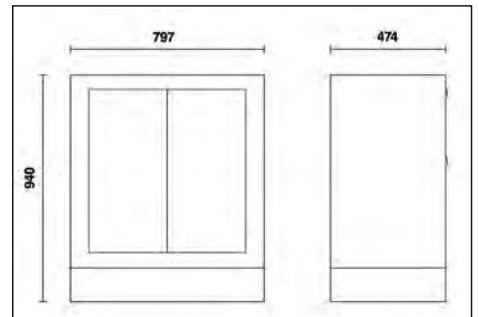

C55 MA

1 055000205

C55MDO

fixed oil distribution module
for workshop equipment combination

- 2 reels with 7m - 1/2" hose included
- Complete with 2 guns with digital litre counter and automatic drip catcher.
- max. flow rate: 35 l/min
- viscosity: 8÷5000 mPas

94 kg

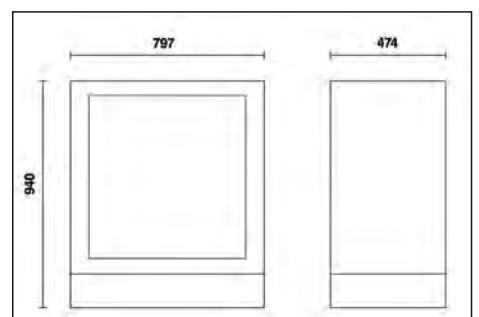

C55MDO

1 055000210

C55MS

fixed service module, for workshop equipment combination

- Built-in waste bin
- Perforated paper roll compartment
- Storage drawer, 305x270 mm

📦 75 kg

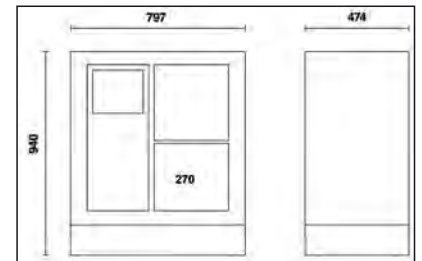

C55 MS

1 055000204

C55T3

trolley

- 3 tops covered in antislip ribbed rubber
- Ergonomic handle
- Two fixing options for central worktop
- Four castors Ø 100 mm (two with brakes)
- Static load capacity: 200 kg (distributed between 3 shelves)

📦 21 kg

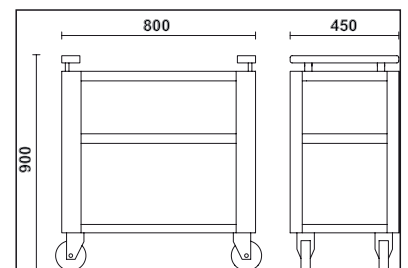

C55T3

1 055000219

C55P/MCD

double central intermediate uprights

10 kg

C55P/MCD

1 055000257



C55P/2MDX-SX

right/left wall uprights, pair

10 kg

C55P/2MDX-SX

1 055000253



C55P/2MDX-SX



C55PM

suspended cabinet for workshop equipment combination, 1 m long

• Dimensions: 1024x400x300 mm; fitted with gas springs, making it easier to open and close door

24 kg

C55PM

1 055000302

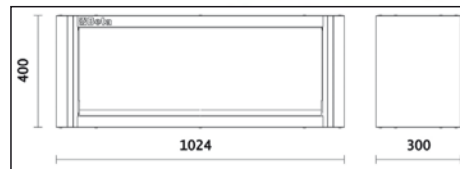

C55PFA-1,0

self-supporting perforated panel, 1 m long, for workshop equipment combination

Perforated steel tool panel (1024x25x1000 mm)

11 kg

C55PFA-1,0

1 055000316

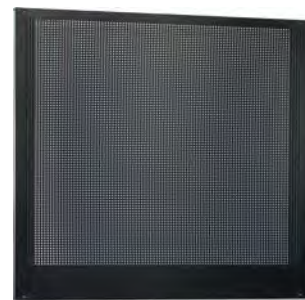

C55/PF

perforated under-cabinet panel for workshop equipment combination, 1 m long

• Perforated tool panel (1024x600 mm)

6 kg

C55/PF

1 055000307



C55PT1,0X0,6

under-cabinet panel, 1 m long

Dimensions: 1024x25x620 mm

8 kg

C55PT1,0X0,6

1 055000314



C55PTE-1,0

under-cabinet panel, 1 m long

Dimensions: 1024x620 mm

Accommodates 2 power sockets (not included)

8 kg

C55PTE-1,0

1 055000319



C55/2PM

tool wall system with 2 suspended cabinets, for workshop equipment combination

- 2 suspended cabinets, 1024x400x300 mm, fitted with gas springs, making it easier to open and close doors.
- Wall panel, 2050x620 mm; can accommodate perforated tool panels C55/PF (to be ordered separately)
- Supplied with framework
- Matches 2-m-long workbench

80 kg

C55 2PM

1 055000301

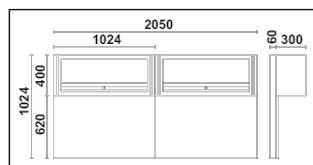
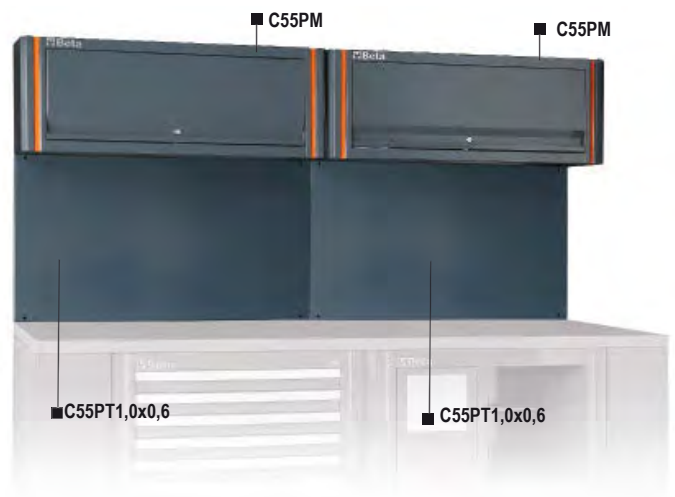

 **Beta**

C55PFA-0,8

self-supporting perforated panel, 0.8 m long, for workshop equipment combination

Perforated steel tool panel (800x25x1000 mm)

10 kg

C55PFA-0,8

1 055000315

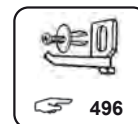

C55PM/M0,8

suspended cupboard, 0.8 m long, for workshop equipment combination

Dimensions: 800x400; fitted with gas springs making it easier to open and close door

19 kg

C55PM/M0,8

1 055000312

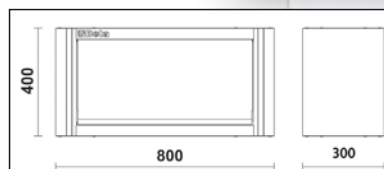

C55PTE-0,8

under-cabinet panel, 0.8 m long

Dimensions: 800x600 mm
Accommodates 1 power socket (not included)

6 kg

C55PTE-0,8

1 055000318



C55PT0,8X0,6

under-cabinet panel, 0.8 m long

Dimensions: 800x25x620 mm

7,8 kg

C55PT0,8X0,6

1 055000313



C55/1PF

perforated tool panel, for workshop equipment combination

• Perforated tool panel (800x600 mm)

5 kg

C55/1PF

1 055000309

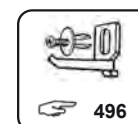

C55PS

tool wall system with shutter, for workshop equipment combination

- Aluminium shutter, vertically adjustable, with lock
- Removable perforated tool panel
- Supplied with framework
- 50-hook GPS kit included
- Matches 2-m-long workbench

88 kg

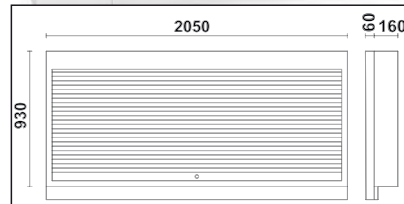

C55PS-O	1	055000250
C55PS-G	1	055000255

C55PSE

tool wall system with shutter
accommodating 2 power sockets

- Aluminium shutter, vertically adjustable, with lock
- Removable perforated tool panel
- Supplied with framework
- 50-hook GPS kit included
- Accommodates power sockets
- Matches 2-m-long workbench

88 kg

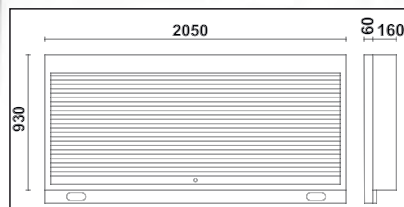

C55PSE-O	1	055000258
C55PSE-G	1	055000260

C55AE

profile, 2 m long, accommodating power sockets

Dimensions: 2050x25x90mm
Accommodates 2 power sockets

1,5 kg



C55AE	1	055000325
-------	---	-----------

C55AC

self-supporting complete corner

Worktop (700x700 mm) with legs
2 upper tool wall systems complete with 2 fixing shelves (665x150 mm)

66 kg

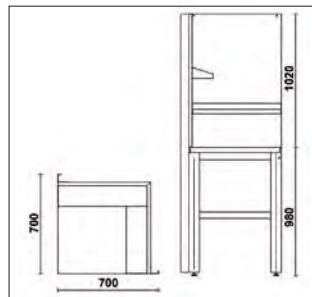

C55AC O

C55AC G

C55AC O	1	055000360
C55AC G	1	055000380

C55KAI

corner worktop for workshop equipment combination

• Painted sheet metal worktop (700x700 mm) covered with a shockproof, non-scratch PVC coat, resistant to hydrocarbons

32 kg



C55AC O

C55AC G

C55KAI O	1	055000365
C55KAI G	1	055000385

C55KAS

upper corner with tool wall systems

• Perforated tool wall systems (700x1000 mm)
• 2 fixing shelves (665x150 mm)

24 kg



C55KAS	1	055000370
--------	---	-----------

C55MP

steel corner wall shelves

Dimensions: 700x160x80 mm



C55MP	1	055000374
-------	---	-----------



C55B/1

workbench, 1 m long, for workshop equipment combination, with fixed module C55M7

Worktop (1024x700 mm) covered with a shockproof, non-scratch PVC coat, resistant to hydrocarbons

• Universal leg with vertically adjustable feet

1 fixed module:

- 7 drawers (588x367 mm) with ball bearing slides
- Aluminium opening system throughout length of drawer
- Drawer bases protected by foamed rubber mats
- Front centralized lock

127 kg



C55BO/1

C55BG/1



h	max
70 mm	30 kg

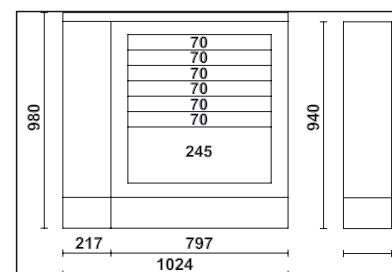
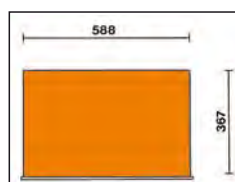

C55BO/1	1	055000090
C55BG/1	1	055000091

C55C

Cargo cabinets, RSC55 system

Developed on the basis of accurate research conducted with trained, professional users, they provide ideal solutions for working comfortably and rationally.

The opening system of the perforated panels of the two doors also allows the interior surface to be made the most of.

Main features:

- 1 drawer with ball bearing slides.
- Easy tool layout according to users' needs.
- Easy wall mounting by means of two slots located at the back of the cabinet.
- Safety lock for both drawers and doors.
- Empty thermoformed tray for 1/2" sockets and accessories.



37 kg

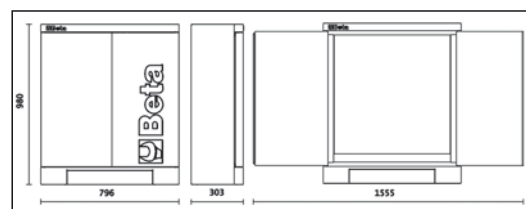

C55C	1	055000400
------	---	-----------

C55A1

sheet metal single-door tool cabinet, for workshop equipment combination

- 3 removable, vertically adjustable shelves
- With lock
- Usable interior dimensions: 177x42x42 cm

50 kg

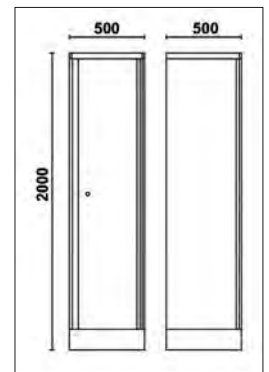
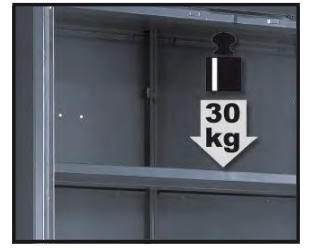

C55A1



1

055000411

C55A1/R42

interior shelf for tool cabinet C55A1

2,4 kg

C55A1/R42

420x420 mm



1

055000461



C55A2

sheet metal two-door tool cabinet, for workshop equipment combination

- 3 removable, vertically adjustable shelves
- With lock
- Usable interior dimensions: 177x70x42 cm

📦 72 kg

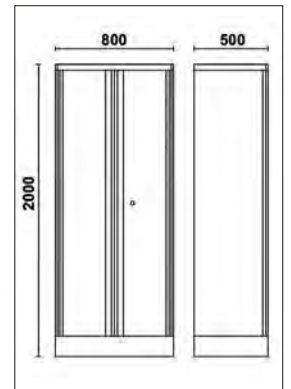

C55A2

📦 1 055000412

C55A2/R70

interior shelf for tool cabinet C55A2

📦 3,5 kg

C55A2/R70

700x420 mm

📦 1 055000462

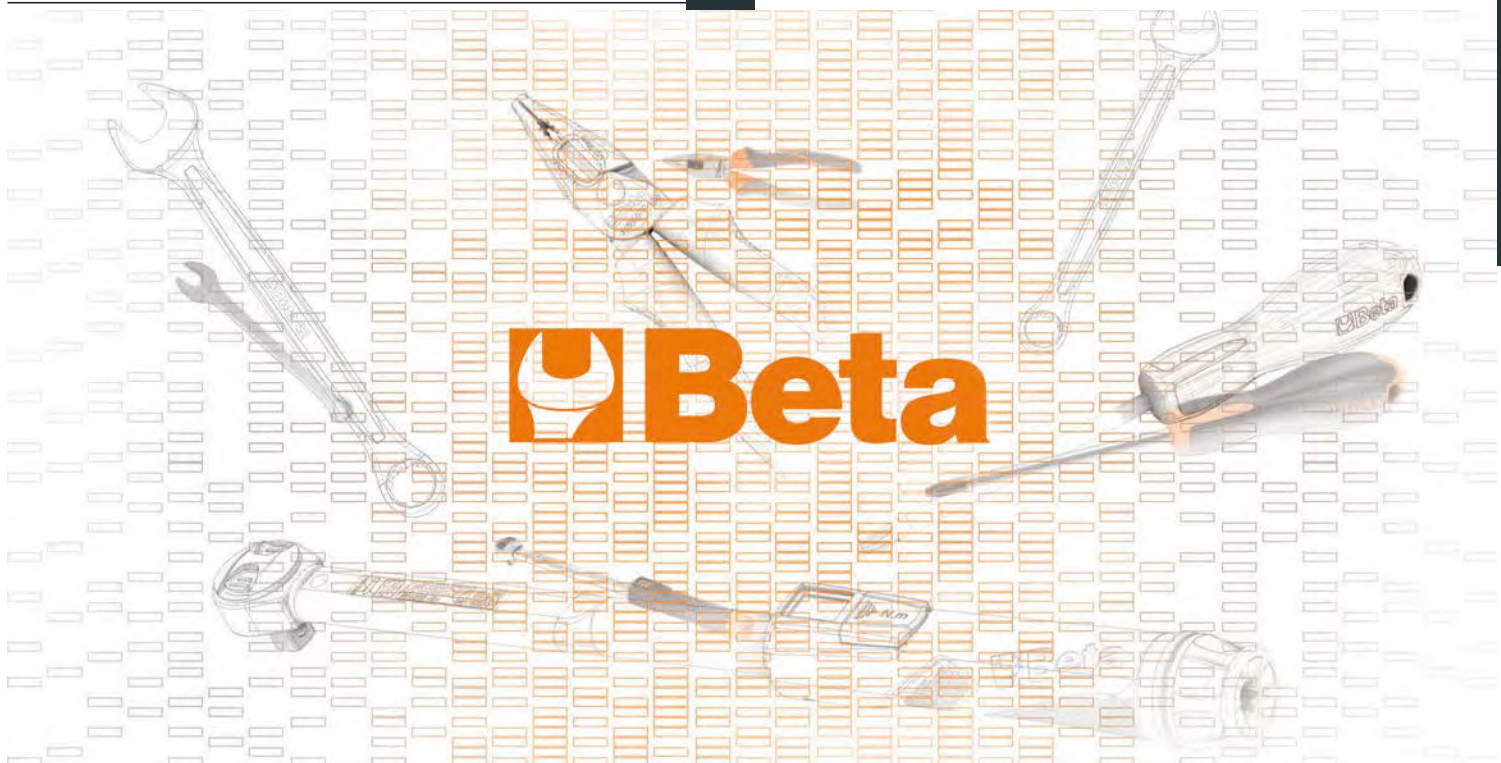

C55AT1

sheet metal tool cabinet with clear polycarbonate door, for workshop equipment combination

- 3 removable, vertically adjustable shelves
- With lock
- Usable interior dimensions: 1770x420x420 mm

41 kg

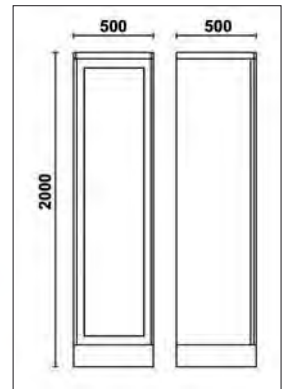

C55AT1

1 055000421

C55AT2

sheet metal tool cabinet with two clear polycarbonate doors, for workshop equipment combination

- 3 removable, vertically adjustable shelves
- With lock
- Usable interior dimensions: 1770x700x420 mm

56 kg

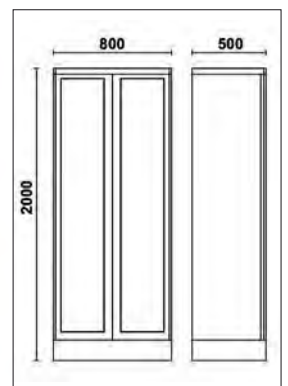

C55AT2

1 055000422

C55STR

adhesive tape 25 m

allows to tailor the vertical tapes of garage furniture item C55



C55STR-O/2011			1	055000901
C55STR-R/3000			1	055000903
C55STR-V/6029			1	055000906
C55STR-W/9016			1	055000907
C55STR-Y/1023			1	055000905
C55STR-B/5015			1	055000904
C55STR-GO/1035			1	055000909
C55STR-S/9006			1	055000902



C45LMP

LED lamp for workshop equipment combination C45 - RSC55

- Length: 630 mm
- Easy to fix under wall cabinet through adhesives
- ON/OFF switch
- 570 lumens



307 g

C45LMP			1	045000320
--------	--	--	---	-----------

9562P2

multilogo mat, 200x80 cm

- particularly suitable for use with workshop equipment item C55 or under motorcycles



9562P2			1	095620400
--------	--	--	---	-----------

9562P12

multilogo mat roll, 25 m x 80 cm

Allows mat length to be customized as needed



9562P12			1	095620425
---------	--	--	---	-----------

C45



C45/X

workshop equipment combination C45

Combination comprising:

- Worktop made of coated MDF stainless steel (C45PX/3-2,0MT)
- Fixed module with 7 drawers (C45M7)
- Fixed service module (C45MS)
- Mobile roller cab with 7 drawers (C45C7)
- Two-door tool cabinet (C45AS2)
- 3 perforated tool panels (C45PF)
- 3 wall-mounted cupboards (C45PM)
- 3 wall brackets, wide type (C45SL)
- 1 wall bracket, narrow type (C45SS)

305 kg

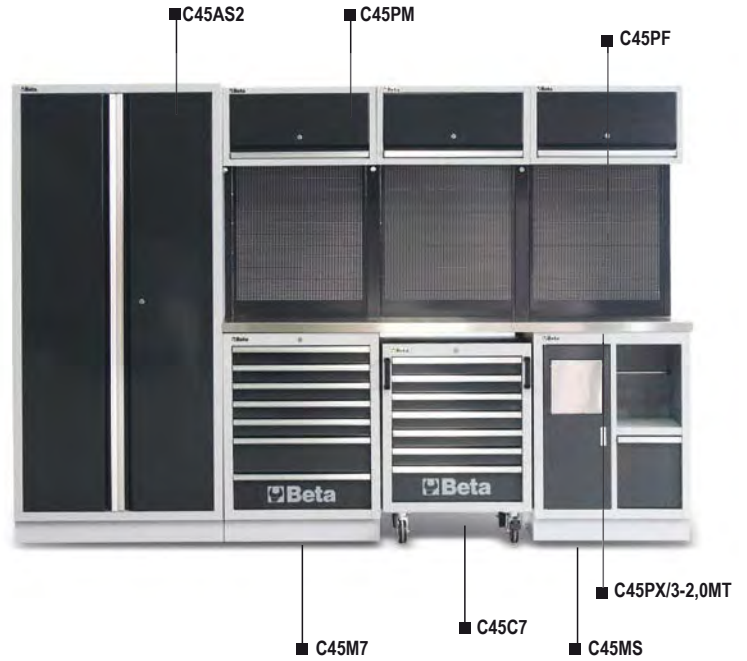

C45/X

1 045000010



C45/W

workshop equipment combination C45

Combination comprising:

- Multi-ply wood worktop (C45PW/3-2,0MT)
- Fixed module with 7 drawers (C45M7)
- Fixed service module (C45MS)
- Mobile roller cab with 7 drawers (C45C7)
- Two-door tool cabinet (C45AS2)
- 3 perforated tool panels (C45PF)
- 3 tool wall systems with 1 wall-mounted cabinet (C45PM)
- 3 wall brackets, wide type (C45SL)
- 1 wall bracket, narrow type (C45SS)

303 kg

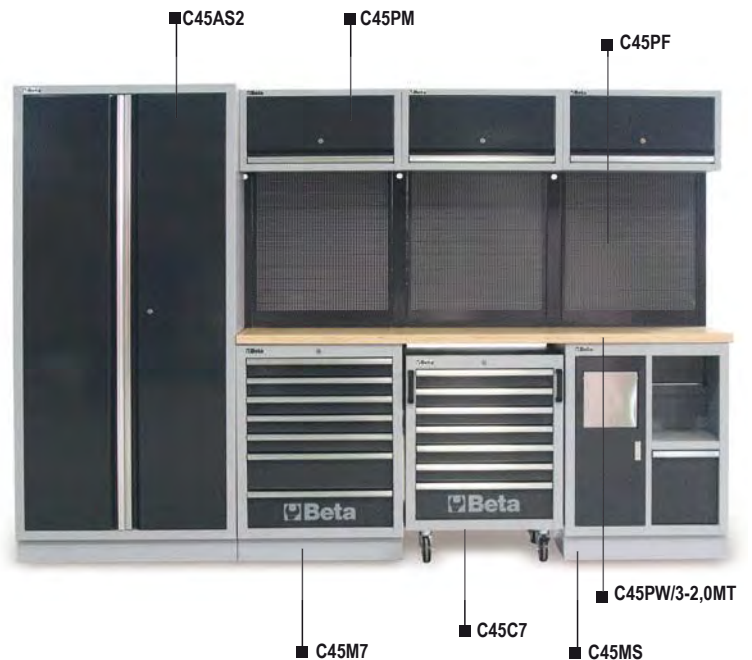

C45/W

1 045000020



C45/AX

workshop equipment combination C45

Combination comprising:

- Worktop made of coated MDF stainless steel (C45PX/3-2.0MT)
- Fixed module with 7 drawers (C45M7)
- Fixed service module (C45MS)
- Fixed two-door module (C45MA)
- 3 wall-mounted cabinets (C45PM)
- 3 perforated tool panels (C45PF)
- 2 wall brackets, wide type (C45SL)
- 2 wall brackets, narrow type (C45SS)

1 206 kg

C45/AX

1 045000030



C45/AW

workbenches for workshop equipment combination C45

Combination comprising:

- Multi-ply wood worktop (C45PW/3-2.0MT)
- Fixed two-door module (C45MA)
- Fixed module with 7 drawers (C45M7)
- Fixed service module (C45MS)
- 3 wall-mounted cabinets (C45PM)
- 3 perforated tool panels (C45PF)
- 2 wall brackets, narrow type (C45SS)
- 2 wall brackets, wide type (C45SL)

1 204 kg

C45/AW

1 045000040

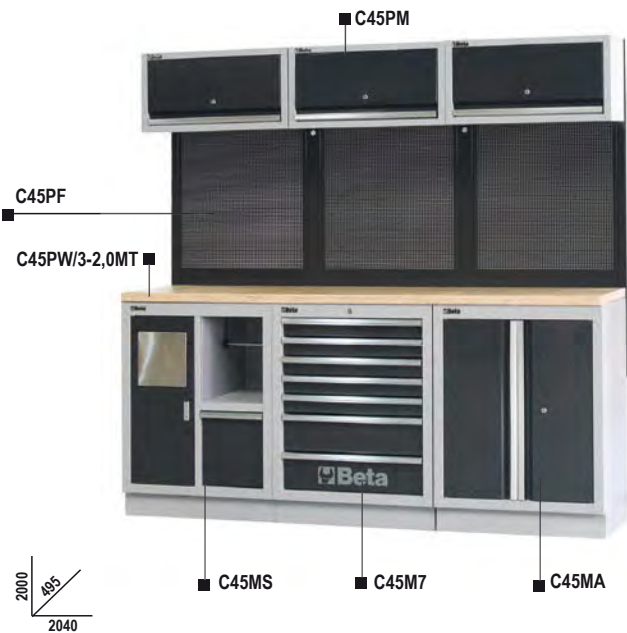

C45/BX

workshop equipment combination C45

Combination comprising:

- Worktop made of coated MDF stainless steel (C45PX/2-1.3MT)
- Fixed module with 5 drawers (C45M5)
- Fixed two-door module (C45MA)
- Single-door tool cabinet (C45AS1)
- 2 wall-mounted cabinets (C45PM)
- 2 perforated tool panels (C45PF)
- 2 wall brackets, wide type (C45SL)
- 1 wall bracket, narrow type (C45SS)

1 191 kg

C45/BX

1 045000043



C45/BW

workshop equipment combination C45

Combination comprising:

- Multi-ply wood worktop (C45PW/2-1,3MT)
- Fixed module with 5 drawers (C45M5)
- Fixed two-door module (C45MA)
- Single-door cabinet (C45AS1)
- 2 wall-mounted cabinets (C45PM)
- 2 perforated tool panels (C45PF)
- 2 wall brackets, wide type (C45SL)
- 1 wall bracket, narrow type (C45SS)

190 kg

C45/BW

1 045000053

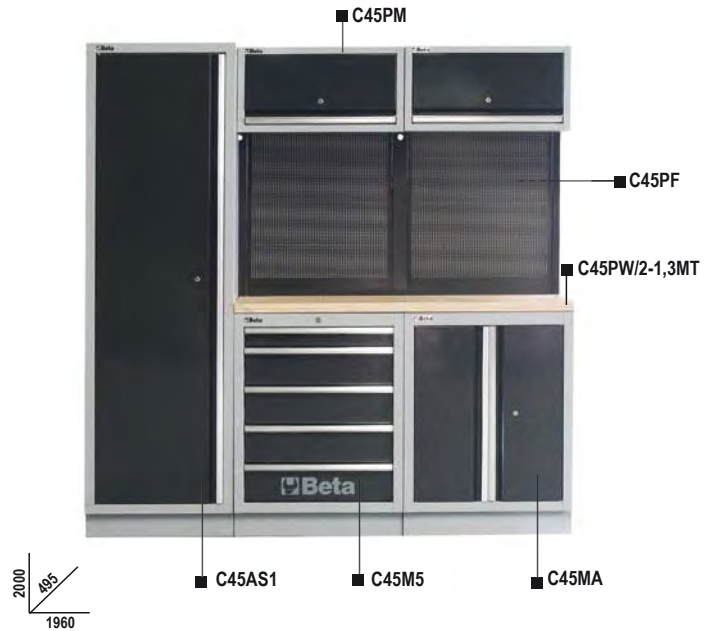

C45/DX

workshop equipment combination C45

Combination comprising:

- 1 worktop made of stainless steel coated MDF (C45PX/3-2,0MT)
- 1 worktop made of stainless steel coated MDF (C45PX/2-1,3MT)
- 1 fixed module with 7 drawers (C45M7)
- 1 mobile roller cab with 7 drawers (C45C7)
- 1 fixed service module (C45MS)
- 1 fixed module with 5 drawers (C45M5)
- 1 fixed module with 2 doors (C45MA)
- 1 self-supporting complete corner with stainless steel coated MDF worktop (C45CORNER/X)
- 5 perforated tool panels (C45PF)
- 5 wall-mounted cabinets (C45PM)
- 7 wall brackets, wide type (C45SL)
- 2 wall brackets, narrow type (C45SS)
- 2 single-door tool cabinets (C45AS1)

572,3 kg

C45/DX

1 045000075

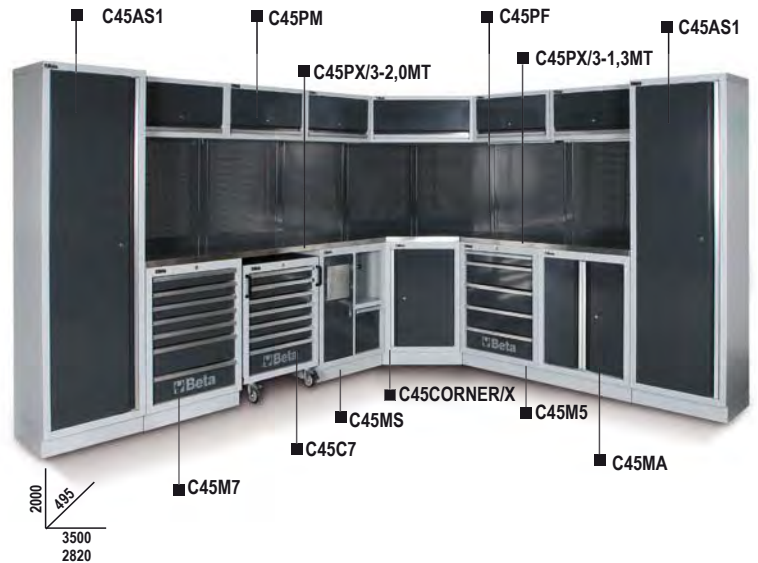

C45/DW

workshop equipment combination C45

Combination comprising:

- 1 multi-ply wood worktop (C45PW/3-2,0MT)
- 1 multi-ply wood worktop (C45PW/2-1,3MT)
- 1 fixed module with 7 drawers (C45M7)
- 1 mobile roller cab with 7 drawers (C45C7)
- 1 fixed service module (C45MS)
- 1 fixed module with 5 drawers (C45M5)
- 1 fixed module with 2 doors (C45MA)
- 1 self-supporting complete corner with wood worktop (C45CORNER/W)
- 5 perforated tool panels (C45PF)
- 5 wall-mounted cabinets (C45PM)
- 7 wall brackets, wide type (C45SL)
- 2 wall brackets, narrow type (C45SS)
- 2 single-door tool cabinets (C45AS1)

568,5 kg

C45/DW

1 045000076



C45/EX

workshop equipment combination C45

Combination comprising:

- 2 perforated tool panels (C45PF)
- 2 wall-mounted cabinets (C45PM)
- 2 wall brackets, wide type (C45SL)
- 1 wall bracket, narrow type (C45SS)
- 1 single-door tool cabinet (C45AS1)
- Fixed module with 7 drawers and worktop made of stainless steel coated MDF (C45M7A/X):
 - 1 drawer 1248x406 mm
 - 6 drawers 782x406 mm
 - 5 drawers 85 mm high, 1 drawer 155 mm high
 - 1 object compartment with intermediate shelf and door

174,6 kg

C45/EX

1 045000078

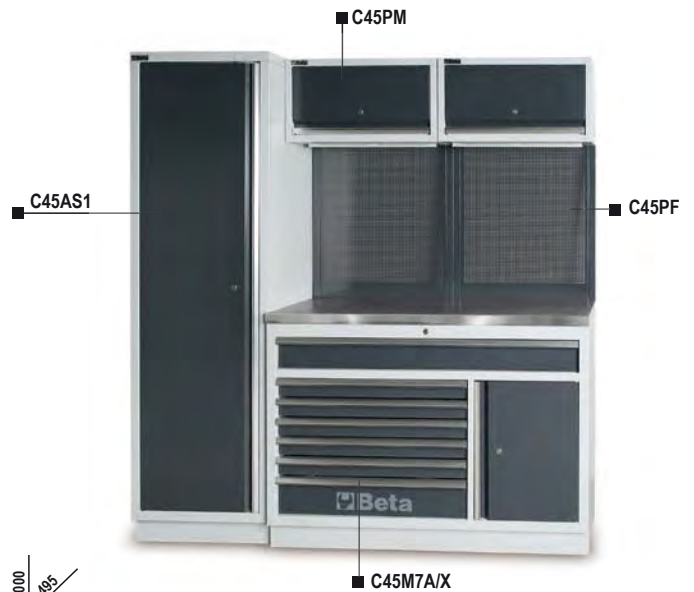

C45/EW

workshop equipment combination C45

Combination comprising:

- 2 perforated tool panels (C45PF)
- 2 wall-mounted cabinets (C45PM)
- 2 wall brackets, wide type (C45SL)
- 1 wall bracket, narrow type (C45SS)
- 1 single-door tool cabinet (C45AS1)
- Fixed module with 7 drawers and multi-ply wood worktop (C45M7A/W):
 - 1 drawer 1248x406 mm
 - 6 drawers 782x406 mm
 - 5 drawers 85 mm high, 1 drawer 155 mm high
 - 1 object compartment with intermediate shelf and door

173,6 kg

C45/EW

1 045000079

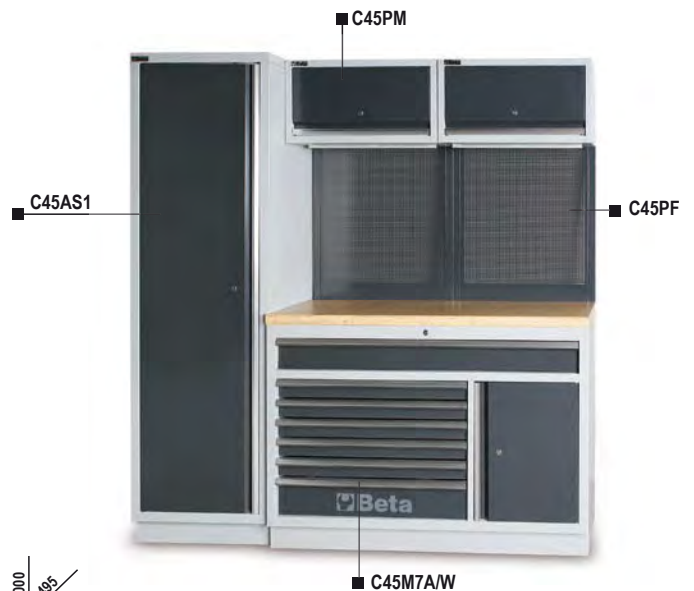

C45/CX

workshop equipment combination C45

Combination comprising:

- Worktop made of coated MDF stainless steel (C45PX/2-1.3MT)
- Fixed module with 7 drawers (C45M7)
- Fixed service module (C45MS)
- Single-door tool cabinet (C45AS1)
- 2 wall-mounted cabinets (C45PM)
- 2 perforated tool panels (C45PF)
- 2 wall brackets, wide type (C45SL)
- 1 wall bracket, narrow type (C45SS)

199 kg

C45/CX

1 045000063

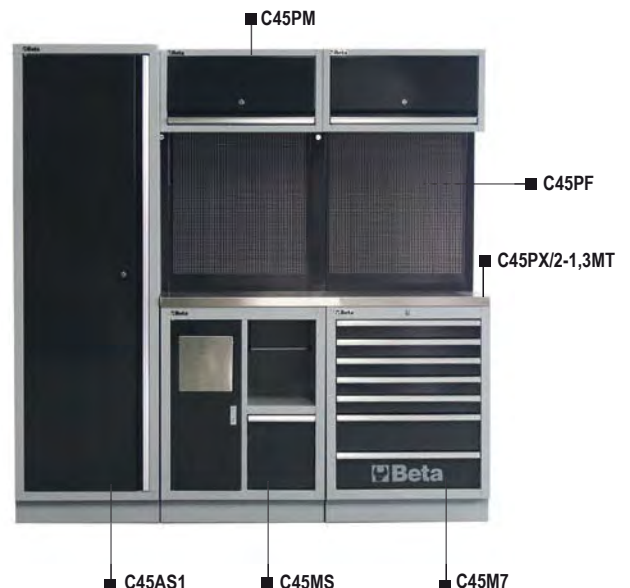

C45/CW

workshop equipment combination C45

Combination comprising:

- Multi-ply wood worktop (C45PW/2-1.3MT)
- Fixed module with 7 drawers (C45M7)
- Fixed service module (C45MS)
- Single-door tool cabinet (C45AS1)
- 2 wall-mounted cabinets (C45PM)
- 2 perforated tool panels (C45PF)
- 2 wall brackets, wide type (C45SL)
- 1 wall bracket, narrow type (C45SS)

198 kg

C45/CW

1 045000073

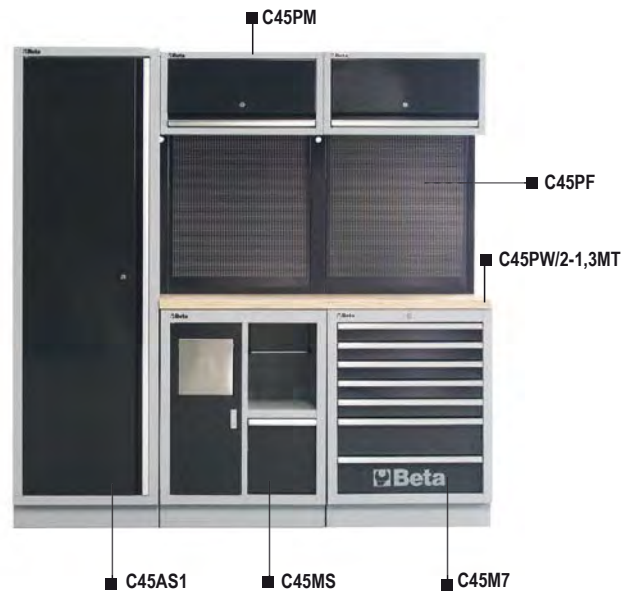

C45/BPX-1,3

workbenches for workshop equipment combination C45/BPX-1,3

Combination comprising:

- Worktop made of coated MDF stainless steel (C45PX/2-1.3MT)
- Fixed module with 7 drawers (C45M7)
- Fixed module with 5 drawers (C45M5)
- 2 perforated tool panels (C45PF)
- 1 wall bracket, wide type (C45SL)
- 2 wall brackets, narrow type (C45SS)

140 kg

C45/BPX-1,3

1 045000083



C45/BPW-1,3

workbenches for workshop equipment combination C45/BPW-1,3

Combination comprising:

- Multi-ply wood worktop (C45PW/2-1.3MT)
- Fixed module with 7 drawers (C45M7)
- Fixed module with 5 drawers (C45M5)
- 2 perforated tool panels (C45PF)
- 1 wall bracket, wide type (C45SL)
- 2 wall brackets, narrow type (C45SS)

139 kg

C45/BPW-1,3

1 045000093



C45/BPX-2,0

workbenches for workshop equipment combination C45/BPX-2,0

Combination comprising:

- Worktop made of coated MDF stainless steel (C45PX/3-2.0MT)
- Fixed module with 7 drawers (C45M7)
- Fixed module with 5 drawers (C45M5)
- 3 perforated tool panels (C45PF)
- 2 wall brackets, wide type (C45SL)
- 2 wall brackets, narrow type (C45SS)

158 kg

C45/BPX-2,0



1 045000090



C45/BPW-2,0

workbenches for workshop equipment combination C45/BPW-2,0

Combination comprising:

- Multi-ply wood worktop (C45PW/3-2.0MT)
- Fixed module with 7 drawers (C45M7)
- Fixed module with 5 drawers (C45M5)
- 3 perforated tool panels (C45PF)
- 2 wall brackets, wide type (C45SL)
- 2 wall brackets, narrow type (C45SS)

156 kg

C45/BPW-2,0



1 045000100



C45M7A/X

fixed module with 7 drawers, for workshop equipment combination

- Worktop (1360 mm) made of stainless steel coated MDF
- 1 drawer (1248x406 mm), with ball bearing slides
- 6 drawers (782x406 mm), with wall bearing slides:
 - 5 drawers 85 mm high
 - 1 drawer 155 mm high
- Drawer bases protected by foamed rubber mats
- Front centralized lock
- Can be fitted with foam trays
- 1 compartment with intermediate shelf and door, interior dimensions 504x424x597 mm

81 kg

C45M7A/X



1 045000160



h	max
65 mm	25 kg
105 mm	40 kg
145 mm	30 kg

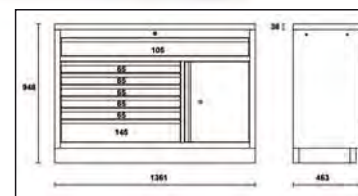

C45M7A/W

fixed module with 7 drawers, for workshop equipment combination

- Multi-ply wood worktop (1360 mm)
- 1 drawer (1248x406 mm), with ball bearing slides
- 6 drawers (782x406 mm), with ball bearing slides:
 - 5 drawers 85 mm high
 - 1 drawer 155 mm high
- Drawer bases protected by foamed rubber mats
- Front centralized lock
- Can be fitted with foam trays
- 1 compartment with intermediate shelf and door, interior dimensions 504x424x597 mm

80 kg



h	max
65 mm	25 kg
105 mm	40 kg
145 mm	30 kg

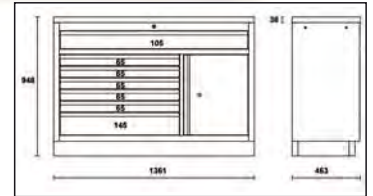

C45M7A/W

1 045000170

C45PX/2-1,3MT

1.3-m-long worktop made of coated MDF stainless steel, for workshop equipment combination C45

Worktop made of coated MDF stainless steel, 1361x463 mm; workbench thickness: 38 mm

21 kg



C45PX/2-1,3MT

1 045000103

C45PW/2-1,3MT

1.3-m-long wood worktop for workshop equipment combination C45

Wood worktop, 1361x463 mm; workbench thickness: 38 mm

20 kg



C45PW/2-1,3MT

1 045000113

C45PX/3-2,0MT

2-m-long worktop made of stainless steel coated MDF for workshop equipment combination C45

Worktop made of stainless steel coated MDF, 2041x463 mm; workbench thickness: 38 mm

31,8 kg



C45PX/3-2,0MT

1 045000110

C45PW/3-2,0MT

2-m-long wood worktop for workshop equipment combination C45

Wood worktop, 2041x463 mm; workbench thickness: 38 mm

30 kg



C45PW/3-2,0MT

1 045000120

C45C7

mobile roller cab with 7 drawers, for workshop equipment combination

- 7 drawers (532x406 mm) with ball bearing slides
- 4 steering castors Ø 100 mm (1 with brake)
- Drawer bases protected by foamed rubber mats

50 kg

h	max
65 mm	25 kg
145 mm	30 kg

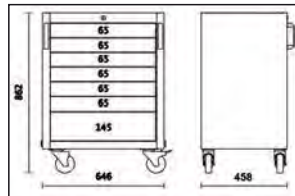
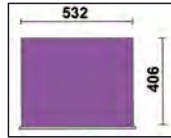

C45C7

1 045000207

C45M5

fixed module with 5 drawers, for workshop equipment combination

- 5 drawers (566x406 mm) with ball bearing slides
- Drawer bases protected by foamed rubber mats
- Front centralized lock
- Can be fitted with foam trays

49,3 kg

h	max
65 mm	25 kg
145 mm	30 kg

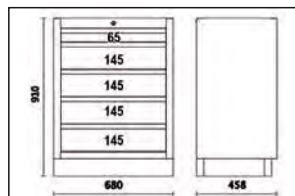

C45M5

1 045000215

C45M7

fixed module with 7 drawers, for workshop equipment combination

- 7 drawers (566x406 mm) with ball bearing slides
- Drawer bases protected by foamed rubber mats
- Front centralized lock
- Can be fitted with foam trays

54,3 kg

h	max
65 mm	25 kg
145 mm	30 kg

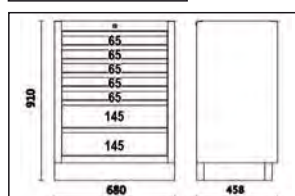

C45M7

1 045000217

C45MS

fixed service module for workshop equipment combination C45

- Built-in waste bin
- Perforated paper roll compartment

37 kg

C45MS

1 045000219

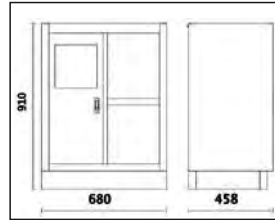

C45MA

fixed two-door module for workshop equipment combination

- With lock
 - Interior shelf, vertically adjustable
 - Interior dimensions: 670x420 mm
- 680x458x910 mm

29,4 kg

C45MA

1 045000212

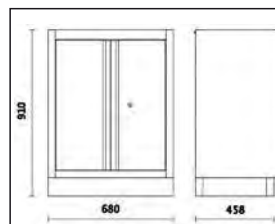

C45SS

side wall brackets, narrow type, for item C45

1420x32.5x30 mm

1,5 kg

C45SS

1 045000332



C45SL

side wall brackets, wide type, for item C45

1420x65x30 mm

2 kg

C45SL

1 045000365



C45PF

perforated tool panel for workshop equipment combination

1052x614.5 mm

5,3 kg

C45PF

1 045000311



C45CORNER/X

self-supporting complete corner

- Suspended corner cabinet with gas springs, making it easier to open and close door
- Two perforated tool panels (1050x860 mm)
- Stainless steel corner worktop (860 x 860 mm)
- Lower corner module with large storage compartment

94 kg

C45CORNER/X

1 045000400



C45CORNER/W

self-supporting complete corner

- Suspended corner cabinet with gas springs, making it easier to open and close door
- Two perforated tool panels (1050x860 mm)
- Multi-ply wood corner worktop (860 x 860 mm)
- Lower corner module with large storage compartment

93 kg

C45CORNER/W

1 045000410



C45PM

wall-mounted suspended cabinet for workshop equipment combination

680x281x350 mm fitted with gas springs, making it easier to open and close door

10 kg

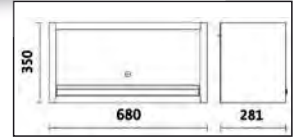

C45PM

1 045000301

C45AS1

sheet metal single-door tool cabinet for workshop equipment combination, with one wide bracket

- 4 removable, vertically adjustable shelves
 - With lock
 - Interior dimensions: 590x430 mm
- 600x458x2000 mm

57,5 kg

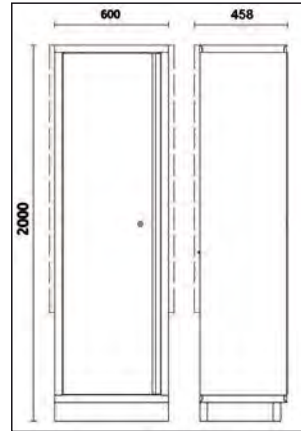

C45AS1

1 045000450

C45AS2

sheet metal two-door tool cabinet for workshop equipment combination, with one wide bracket

- 4 removable, vertically adjustable shelves
 - With lock
 - Interior dimensions: 910x430 mm
- 915x458x2000 mm

80 kg

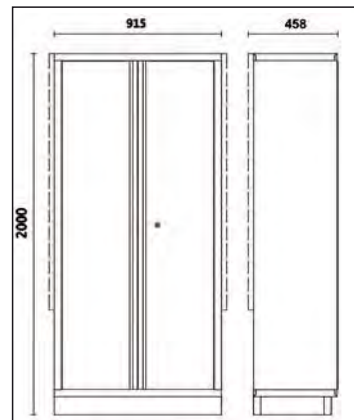

C45AS2

1 045000480

C45LMP

LED lamp for workshop equipment combination C45 - RSC55

- Length: 630 mm
- Easy to fix under wall cabinet through adhesives
- ON/OFF switch
- 570 lumens



📦 307 g

C45LMP 1 045000320



PM/5C

5-tray tool holder, made of plastic, with support

- Interior dimensions of tray: 95x120 mm
- Can be used with tool wall systems C45 and RSC55

📦 1,8 kg

PM/5C 1 088880450

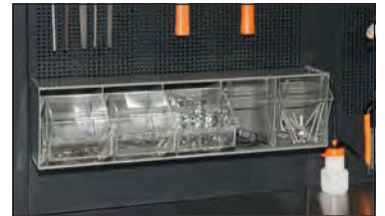

PM/6C

6-tray tool holder, made of plastic, with support

- Interior dimensions of tray: 80x60 mm
- Can be used with tool wall systems C45 and RSC55

📦 970 g

PM/6C 1 088880440



CP

wall-mounted bottle holder rack, made of steel

- Can be used with wall-mounted tool panels



CP 1 088880470



ROLLER CABS & CONTAINERS

C24S/8	C24SA/8																C57SP		
C37/8	C39/8	C24SA-XL/9	C25	C27S	C28	C30S	C35	C38	C39MMD	C39T	C45	C54S	C55	C55PS	C57SA	C58P	C59A	C59B	
										453									
										454									
			412	412															
457													457				457	457	
			460																
			461																
						417													
												468							
												391							
														439	439				
															469				
															421				
											440			440		440			
455	455			455					455	455			455				455	455	
422	422			422					422	422			422				422	422	
423	423			423					423	423			423				423	423	
			437																
							445												
							464												
							419												
								467		467									
442	442			442														442	
443	443								443	443			443				443	443	
444	444			444					444				444					444	
429	429			429					429				429				429	429	
449	449			449					449	449			449				449	449	
413	413			413					413	413			413				413	413	
414	414			414					414				414				414	414	
415	415			415					415				415					415	
456	456			456					456	456			456				456	456	
458	458			458					458	458			458				458	458	
459	459			459					459				459				459	459	
424	424			424					424	424			424				424	424	
425	425			425					425	425			425				425	425	
426	426								426	426			426				426	426	
				462															
416	416			416														416	
427	427			427					427				427				427	427	
						463													
						418													
								438											

Industrial maintenance



19.5 kg

Quantity/Description

Beta N.

Quantity/Description

Beta N.

6	pin punches Ø 2 - 3 - 4 - 5 - 6 - 8 mm	31	1	electrician's scissors, straight blades	1128BMX
1	centre punch Ø 3 mm	32	1	heavy duty combination pliers, bi-material handles, industrial finish = 180 mm	1150GBM
1	flat chisels, ribbed type 200 mm	35	1	extra-long needle knurled nose pliers, bi-material handles, industrial finish ● 160 mm	1166GBM
26	combination wrenches 6+32 mm	42NEW/S26	8	screwdrivers for cross head Phillips® screws ● 2,5x50 - 3x75 - 3,5x100 - 4x125 - 5,5x125 - 6,5x150 - 8x200 - 10x200 mm	1260
12	double open end wrenches 6x7 - 8x9 - 10x11 - 12x13 - 14x15 - 16x17 18x19 - 20x22 - 21x23 - 24x26 - 25x28 - 30x32 mm	55/S12	4	screwdrivers for cross head Phillips® screws ⊕ PH0x60 - PH1x80 - PH2x100 - PH3x150 mm	1262
9	offset hexagon key wrenches ○ 1,5 - 2 - 2,5 - 3 - 4 - 5 - 6 - 8 - 10 mm	96N/SC9	1	engineer's hammer 500 g	1370
1	adjustable wrench 300 mm	111	1	dead blow hammer Ø 40 mm	1392
13	1/2" square drive hexagon sockets with rail ○ 10+22 mm	920A/SB13	1	engineer's scriber	1688A
1	1/2" drive extension bar 125 mm	920/21	1	measuring tape 5 m	1692
1	1/2" drive extension bar 255 mm	920/22	1	metric feeler gauge	1708/20
1	1/2" drive universal joint	920/25	5	Set of 5 second-cut files, with handles 200 mm	1719BMA...S5
1	1/2" drive sliding T-handle	920/42	1	hacksaw frame, aluminium handle	1726BM
1	1/2" drive reversible ratchet ⊗	920/55	1	metal oil can 300 cc	1751
1	Slip joint pliers boxed joints 250 mm	1048	1	snap - off blade utility knife	1771BM
1	self - locking pliers 240 mm	1052	1	magnetic, articulated lamp with high-brightness LEDs, made of sturdy anodized aluminium, up to 500 lumens	1837F
1	heavy duty diagonal cutting nippers, bi-material handles, industrial finish † 160 mm	1084GBM			
1	compound leverage shears, straight blades 250 mm	1122			

5902VI

059021060

Assortment recommended in combination with C22S - C23S - C23ST - C25 - C27S

5904VI/1T

assortment of 98 tools in ABS thermoformed trays

Industrial maintenance



Quantity/Description

19	1/2" square drive hexagon sockets \odot 10-24 - 26 - 27 - 30 - 32 mm
5	1/2" drive, socket drivers for hexagon screws \odot 5 - 6 - 8 - 10 - 12 mm
1	1/2" drive extension bar 125 mm
1	1/2" drive extension bar 255 mm
1	1/2" drive universal joint
1	1/2" drive sliding T-handle
1	1/2" drive reversible ratchet \otimes
16	combination wrenches 6-21 mm
5	combination wrenches 22-24-27-30-32 mm
1	Slip joint pliers boxed joints 250 mm
1	self - locking pliers 240 mm
1	Heavy-duty diagonal cutting nippers \llcorner 160 mm
1	half-round needle nose pliers \equiv 180 mm
1	Extra-long needle nose pliers \bullet 160 mm
1	circlip pliers straight, internal \odot 180 mm
1	circlip pliers bent, internal \odot 170 mm

Beta N.	TR
920A	T80
920ME	T80
920/21	T80
920/22	T80
920/25	T80
920/42	T80
920/55	T80
42NEW	T05
42NEW	T06
1048	T153
1052	T153
1084	T138
1150	T138
1166	T138
1032	T145
1034	T145

Quantity/Description

1	circlip pliers straight, external \bullet 175 mm	1036	T145
1	circlip pliers bent, external \bullet 175 mm	1038	T145
5	second cut files 200 mm	1719BMA8/S5	T236
2	flat chisels, ribbed type 100 - 200 mm	35	T234
1	engineer's hammer 300 g	1370	T234
1	soft face hammer \varnothing 35 mm	1390	T234
8	double open end wrenches 6x7 - 8x9 - 10x11 - 12x13 - 14x15 - 16x17 - 18x19 - 20x22 mm	55	T33
9	offset hexagon key wrenches \odot 1,5 - 2 - 2,5 - 3 - 4 - 5 - 6 - 8 - 10 mm	96/SC9	T33
4	screwdrivers for cross head Phillips® screws \bullet 3x75 - 4x100 - 5,5x150 - 6,5x150 mm	1260	T208
3	screwdrivers for cross head Phillips® screws \oplus PH0x60 - PH1x80 - PH2x100 mm	1262	T208
6	T-handle wrenches with hexagon male ends \odot 2,5 - 3 - 4 - 5 - 6 - 8 mm	951	T68

5904VI/1T

059041161

Assortment recommended in combination with C24S - C24SA - C24SA-XL - C37 - C39 with 6 - 7 - 8 drawers
C23ST - C39T - C24SL - C24SL/CAB - C59 - C55 - C28 - C39MD - C39SM

Industrial maintenance



T05 T06 T31



T40 T83 T91



T167 T168



T153 T138 T145 T68



T236 T234 T281 T289

Quantity/Description

- 16 combination wrenches 6+21 mm
- 5 combination wrenches 22 - 24 - 27 - 30 - 32 mm
- 5 pin punches Ø 2 - 3 - 4 - 5 - 6 mm
- 1 centre punch Ø 4 mm
- 12 double open end wrenches 6x7 - 8x9 - 10x11 - 12x13 - 14x15 - 16x17 - 18x19 - 20x22 - 21x23 - 24x26 - 27x29 - 30x32 mm
- 9 offset hexagon key wrenches Ø 1,5 - 2 - 2,5 - 3 - 4 - 5 - 6 - 8 - 10 mm
- 7 double ended offset ring wrenches 6+29 mm
- 19 1/2" square drive hexagon sockets Ø 10+24 - 26 - 27 - 30 - 32 mm
- 1 1/2" drive extension bar 125 mm
- 1 1/2" drive extension bar 255 mm
- 1 1/2" drive universal joint
- 1 1/2" drive sliding T-handle
- 1 1/2" drive reversible ratchet
- 13 1/4" hexagon sockets Ø 4+14 mm
- 6 1/4" socket drivers for hexagon screws Ø 2,5+8 mm
- 1 1/4" drive extension bar 50 mm
- 1 1/4" drive extension bar 150 mm
- 1 1/4" drive universal joint
- 1 1/4" drive spinner handle
- 1 1/4" drive swivel T-handle
- 1 1/4" reversible ratchet
- 9 screwdrivers for cross head Phillips® screws ● 3x75 - 3x100 - 4x100 - 4x150 - 5,5x100 - 5,5x150 - 6,5x150 - 8x150 - 10x200 mm
- 2 screwdrivers for slotted head screws, extra-short series ● 4x30 - 6,5x30 mm
- 7 screwdrivers for cross head Phillips® screws ● PH0x60 - PH0x100 - PH1x80 - PH1x120 - PH2x100 - PH2x150 - PH3x150 mm

Beta N.

TR

- 42NEW T05
- 42NEW T06
- 31 T31
- 32 T31
- 55 T31
- 96N/SC9 T31
- 90 T40
- 920A T83
- 920/21 T83
- 920/22 T83
- 920/25 T83
- 920/42 T83
- 920/55 T83
- 900 T91
- 900ME T91
- 900/20 T91
- 900/21 T91
- 900/25 T91
- 900BG/30 T91
- 900/42 T91
- 900/55 T91
- 1260 T167
- 1262 T168

Quantity/Description

- 2 screwdrivers for cross head Phillips® screws, extra - short series ● PH1x30 - PH2x30 mm
- 1 Slip joint pliers boxed joints 250 mm
- 1 self - locking pliers 240 mm
- 1 Heavy-duty diagonal cutting nippers 160 mm
- 1 Extra-long needle nose pliers ● 160 mm
- 1 half-round needle nose pliers = 180 mm
- 1 circlip pliers straight, internal Ø 180 mm
- 1 circlip pliers bent, internal Ø 170 mm
- 1 circlip pliers straight, external ● 175 mm
- 1 circlip pliers bent, external ● 175 mm
- 6 T-handle wrenches with hexagon male ends Ø 2,5 - 3 - 4 - 5 - 6 - 8 mm
- 5 second cut files 200 mm
- 2 flat chisels, ribbed type 100 - 200 mm
- 1 engineer's hammer 300 g
- 1 soft face hammer Ø 35 mm
- 1 riveting pliers
- 100 aluminium rivets 2,9x6 mm
- 100 aluminium rivets 3,2x8 mm
- 100 aluminium rivets 3,8x10 mm
- 100 aluminium rivets 4x12 mm
- 100 aluminium rivets 4,8x12 mm
- 1 measuring tape
- 1 mini hacksaw frame
- 1 plastic oil bottle
- 1 snap - off blade utility knife

Beta N.

TR

- 1262N T168
- 1048 T153
- 1052 T153
- 1084 T138
- 1166 T138
- 1150 T138
- 1032 T145
- 1034 T145
- 1036 T145
- 1038 T145
- 951 T68
- 1719BMA8/S5 T236
- 35 T234
- 1370 T234
- 1390 T234
- 1741B T281
- 1741RV...K T281
- 1741RV...K T281
- 1741RV...K T281
- 1741RV...K T281
- 1741RV...K T281
- 1692 T289
- 1725CR T289
- 1755 T289
- 1771 T289

Industrial maintenance



T05 T06

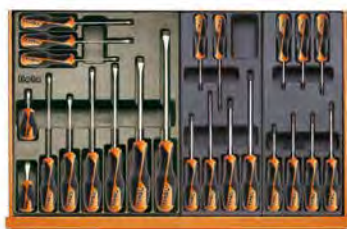

T167 T202 T205



T80 T73 T68



T137 T153 T145 T146



T231 T297 T281



T285 VP6

Quantity/Description	Beta N.	TR	Quantity/Description	Beta N.	TR
16 combination wrenches 6÷21 mm	42NEW	T05	1 Heavy-duty diagonal cutting nippers ∇ 160 mm	1084BM	T137
5 combination wrenches 22 - 24 - 27 - 30 - 32 mm	42NEW	T06	1 Slip joint pliers boxed joints 250 mm	1048	T153
5 pin punches \varnothing 2 - 3 - 4 - 5 - 6 mm	31	T31	1 self - locking pliers 240 mm	1052	T153
1 centre punch \varnothing 4 mm	32	T31	1 circlip pliers straight, internal \varnothing 180 mm	1032	T145
12 double open end wrenches 6x7 - 8x9 - 10x11 - 12x13 - 14x15 - 16x17	55	T31	1 circlip pliers bent, internal \varnothing 170 mm	1034	T145
18x19 - 20x22 - 21x23 - 24x26 - 27x29 - 30x32 mm			1 circlip pliers straight, external \bullet 175 mm	1036	T145
9 offset hexagon key wrenches \varnothing 1,5 - 2 - 2,5 - 3 - 4 - 5 - 6 - 8 - 10 mm	96N/SC9	T31	1 circlip pliers bent, external \bullet 175 mm	1038	T145
9 screwdrivers for cross head Phillips® screws \bullet 3x75 - 3,5x100 - 4x100 - 4x150 - 5,5x100 - 5,5x150 - 6,5x150 - 8x150 - 10x200 mm	1260	T167	1 circlip pliers straight, internal \varnothing 140 mm	1032	T146
2 screwdrivers for slotted head screws, extra-short series \bullet 4x30 - 6,5x30 mm	1260N	T167	1 circlip pliers bent, internal \varnothing 225 mm	1034	T146
6 screwdrivers for cross head Phillips® screws \oplus PH0x60 - PH0x100 - PH1x80 - PH1x120 - PH2x100 - PH2x150 mm	1262	T202	1 circlip pliers straight, external \bullet 140 mm	1036	T146
7 drivers for Torx® head screws \odot T6-T7-T8-T9-T10-T15-T20	1267TX	T205	1 circlip pliers bent, external \bullet 225 mm	1038	T146
5 1/2" drive, socket drivers for hexagon screws \varnothing 5 - 6 - 8 - 10 - 12 mm	920ME	T80	1 engineer's hammer 400 g	1370	T231
1 1/2" drive extension bar 125 mm	920/21	T80	1 soft face hammer \varnothing 35 mm	1390	T231
1 1/2" drive extension bar 255 mm	920/22	T80	1 second cut files 200 mm	1719BMA8/T	T231
1 1/2" drive universal joint	920/25	T80	1 second cut files 200 mm	1719BMA8/P	T231
1 1/2" drive sliding T-handle	920/42	T80	1 second cut files 200 mm	1719BMA8/M	T231
1 1/2" drive reversible ratchet \oplus	920/55	T80	1 digital vernier	1651DGT	T297
19 1/2" square drive hexagon sockets \varnothing 10÷24 - 26 - 27 - 30 - 32 mm	920A	T80	1 flexible graduated rule 300 mm	1682	T297
8 double ended bi-hex tubular socket wrenches 6x7 - 8x9 - 10x11 - 12x13 - 14x15 - 16x17 - 18x19 - 20x22 mm	930	T73	1 measuring tape 5 m	1691BM	T297
1 tommy bars for tubular wrenches	940/1	T73	1 riveting pliers 250 mm	1741B	T281
1 tommy bars for tubular wrenches	940/2	T73	100 aluminium rivets 2,9x6 mm	1741RV...K	T281
6 T-handle wrenches with hexagon male ends \varnothing 2,5 - 3 - 4 - 5 - 6 - 8 mm	951	T68	100 aluminium rivets 3,2x8 mm	1741RV...K	T281
1 half-round needle nose pliers \equiv 180 mm	1150BM	T137	100 aluminium rivets 3,8x10 mm	1741RV...K	T281
1 Extra-long needle nose pliers \bullet 160 mm	1166BM	T137	100 aluminium rivets 4x12 mm	1741RV...K	T281
			100 aluminium rivets 4,8x12 mm	1741RV...K	T281
			1 tin snips 250 mm	1112	T285
			1 electrician's scissors, straight blades	1128BM	T285
			1 hacksaw frame, aluminium handle	1726	T285
			(5) blades for hacksaw	1728BM	T285
			1 plastic oil can 200 cc	1753	T285
			empty thermoformed tray	VP6	VP6

Industrial maintenance



Quantity/Description

Beta N. TR

Quantity/Description

Beta N. TR

5	1/2" drive, socket drivers for hexagon screws \odot 5 - 6 - 8 - 10 - 12 mm	920ME	T80	100	aluminium rivets 4x12 mm	1741RV...K	T281
1	1/2" drive extension bar 125 mm	920/21	T80	100	aluminium rivets 4,8x12 mm	1741RV...K	T281
1	1/2" drive extension bar 255 mm	920/22	T80	1	Slip joint pliers boxed joints 250 mm	1048	T153
1	1/2" drive universal joint	920/25	T80	1	self - locking pliers 240 mm	1052	T153
1	1/2" drive sliding T-handle	920/42	T80	5	Set of 5 second-cut files, with handles 200 mm	1719BMA...S5	T236
1	1/2" drive reversible ratchet \oplus	920/55	T80	1	circlip pliers straight, internal \odot 180 mm	1032	T145
19	1/2" square drive hexagon sockets \odot 10+24 - 26 - 27 - 30 - 32 mm	920A	T80	1	circlip pliers bent, internal \odot 170 mm	1034	T145
16	combination wrenches 6+21 mm	42NEW	T05	1	circlip pliers straight, external \bullet 175 mm	1036	T145
5	combination wrenches 22 - 24 - 27 - 30 - 32 mm	42NEW	T06	1	circlip pliers bent, external \bullet 175 mm	1038	T145
13	1/4" hexagon sockets \odot 4+14 mm	900	T91	1	half-round needle nose pliers \equiv 180 mm	1150BM	T137
6	1/4" socket drivers for hexagon screws \odot 2,5 - 3 - 4 - 5 - 6 - 8 mm	900ME	T91	1	Extra-long needle nose pliers \bullet 160 mm	1166BM	T137
1	1/4" drive extension bar 50 mm	900/20	T91	1	Heavy-duty diagonal cutting nippers ∇ 160 mm	1084BM	T137
1	1/4" drive extension bar 150 mm	900/21	T91	5	pin punches \odot 2 - 3 - 4 - 5 - 6 mm	31	T31
1	1/4" drive spinner handle	900BG/30	T91	1	centre punch \odot 4 mm	32	T31
1	1/4" drive universal joint	900/25	T91	12	double open end wrenches 6x7 - 8x9 - 10x11 - 12x13 - 14x15 - 16x17	55	T31
1	1/4" drive swivel T-handle	900/42	T91		18x19 - 20x22 - 21x23 - 24x26 - 27x29 - 30x32 mm		
1	1/4" reversible ratchet \oplus	900/55	T91	9	offset hexagon key wrenches \odot 1,5 - 2 - 2,5 - 3 - 4 - 5 - 6 - 8 - 10 mm	96N/SC9	T31
6	T-handle wrenches with hexagon male ends \odot 2,5 - 3 - 4 - 5 - 6 - 8 mm	951	T68	1	tin snips 250 mm	1112	T285
7	double ended offset ring wrenches 6x7-8x9-10x11-12x13-14x15-16x17-18x19 mm	90	T40	1	electrician's scissors, straight blades	1128BM	T285
5	double ended offset ring wrenches 20x22 - 21x23 - 24x26 - 25x28 - 27x29 mm	90	T41	1	hacksaw frame, aluminium handle	1726	T285
7	screwdrivers for cross head Phillips® screws \bullet 2,5x50 - 3x75 - 3,5x100 - 4x125 - 5,5x100 - 5,5x150 - 6,5x150 mm	1260	T199	5	blades for hacksaw	1728BM	T285
6	screwdrivers for cross head Phillips® screws \oplus PH0x60 - PH0x100 - PH1x80 - PH1x120 - PH2x100 - PH2x150 mm	1262	T202	1	plastic oil can 200 cc	1753	T285
3	screwdrivers for cross head Phillips® screws \bullet 8x200 - 10x150 - 10x200 mm	1260	T201	1	empty thermoformed tray	VP5	VP5
2	screwdrivers for slotted head screws, extra-short series \bullet 4x30 - 6,5x30 mm	1260N	T201	1	adjustable tap wrench M3+M12	435/1,5	T273
2	screwdrivers for cross head Phillips® screws \oplus PH3x150 - PH4x200 mm	1262	T204	1	adjustable tap wrench M5+M21	435/3	T273
2	screwdrivers for cross head Phillips® screws, extra - short series \oplus PH1x30 - PH2x30 mm	1262N	T204	1	reversible ratcheting tap wrench 2,0+5,0 mm (M3+M8)	436/1	T273
2	flat chisels, ribbed type 100 - 200 mm	35	T234	1	reversible ratcheting tap wrench 4,6+8,0 mm (M5+M12)	436/2	T273
1	engineer's hammer 300 g	1370	T234	1	die stock 25,4 mm	444/1	T273
1	soft face hammer \odot 35 mm	1390	T234	1	die stock 38,1 mm	444/2	T273
1	riveting pliers 250 mm	1741B	T281	1	screw pitch gauge 0,25+6 W 62+4x1"	1707	T273
100	aluminium rivets 2,9x6 mm	1741RV...K	T281	26	coarse pitch hand taps M3 - 4 - 5 - 6 - 7 - 8 - 9 - 10 - 12 - 14 - 16 - 18 - 20	430	T270
100	aluminium rivets 3,2x8 mm	1741RV...K	T281	14	fine pitch hand taps M6x0,75 - M8x1 - M10x1,25 - M12x1,5 - M14x1,5 - M16x1,5 - M18x1,5	433	T270
100	aluminium rivets 3,8x10 mm	1741RV...K	T281	7	round dies, coarse pitch M3 - 4 - 5 - 6 - 7 - 8 - 9	440	T270
				6	round dies, coarse pitch M10 - 12 - 14 - 16 - 18 - 20	440A	T270
				2	round dies, fine pitch M6x0,75 - M8x0,75	441	T270
				5	round dies, fine pitch M10x1,25 - M12x1,5 - M14x1,5 - M16x1,5 - M18x1,5	441A	T270



Quantity/Description

6	pin punches Ø 2 - 3 - 4 - 5 - 6 - 8 mm	31/B6
1	centre punch Ø 4 mm	32
2	flat chisels, ribbed type 125 - 250 mm	35
1	cape chisel, ribbed type 200 mm	37
30	combination wrenches 6-7-8-9-10-11-12-13-14-15-16-17-18-19-20-21-22-23-24-25-26-27-28-29-30-32-35-36-38-41 mm	42NEW
14	double open end wrenches 6x7 - 8x9 - 10x11 - 12x13 - 14x15 - 16x17 - 18x19 - 20x22 - 21x23 - 24x26 - 25x28 - 27x29 - 30x32 - 36x41 mm	55
13	double ended offset ring wrenches 6x7+30x32 mm	90
14	offset hexagon key wrenches ○ 1,5 - 2 - 2,5 - 3 - 4 - 5 - 6 - 8 - 10 - 12 - 13 - 14 - 17 - 19 mm	96N
1	adjustable wrench 250 mm	111
1	heavy duty pipe wrench 300 mm	362
25	twist drills with cylindrical shanks, short series 1+13x0,5 mm	412/SP25
37	assortment of HSS taps and dies, metric thread	447/C37
1	click-type torque wrenches with reversible ratchets @ 1/2", 40+200 Nm	666N/20
1	1/2" drive swivel T-handle	920/40
4	1/2" drive, socket drivers for hexagon screws ○ 10-12-14-17 mm	920ME
25	20 sockets and 5 accessories	920A/C20X
17	assortment of 12 sockets and 5 accessories 3/4"	928A/C12
12	double ended hexagon/bi - hex offset socket wrenches 8 - 10 - 11 - 13 - 14 - 17 - 19 - 22 - 24 - 27 - 30 - 32 mm	932
14	T-handle wrenches with hexagon male ends 2+14 mm	951/S14
5	T handle wrenches with swivelling hexagon male ends ○ 3 - 4 - 5 - 6 - 8 mm	953
3	circlip pliers straight, internal ○ 180 - 225 - 300 mm	1032
3	circlip pliers bent, internal ○ 170 - 210 - 290 mm	1034
3	circlip pliers straight, external ● 140x1,3 - 175 - 225 mm	1036
3	circlip pliers bent, external ● 135x1,3 - 175 - 220 mm	1038
2	Slip joint pliers boxed joints 250 - 300 mm	1048
1	self locking pliers, double adjustment	1051

Beta N.

Quantity/Description

1	heavy duty diagonal cutting nippers, bi-material handles, industrial finish ≡ 160 mm	1084GBM
1	toggle lever assisted end cutting nippers ≡ 180 mm	1092V
1	tin snips 300 mm	1112
1	tin snip, straight narrow blades 250 mm	1114
1	electrician's scissors, straight blades	1128BMX
1	heavy duty combination pliers, bi-material handles, industrial finish ≡ 180 mm	1150GBM
1	extra-long needle knurled nose pliers, bi-material handles, industrial finish ● 160 mm	1166GBM
1	extra-long bent needle knurled nose pliers, bi-material handles, industrial finish ● 160 mm	1168GBM
9	screwdrivers for cross head Phillips® screws ● 2,5x50 - 3x75 - 3,5x150 - 4x125 - 5,5x125 - 6,5x150 - 8x200 - 10x200 - 12x250 mm	1260
2	screwdrivers for slotted head screws, extra-short series ● 4x30 - 6,5x30 mm	1260N
5	screwdrivers for cross head Phillips® screws ● PH0x100 - PH1x120 - PH2x150 - PH3x150 - PH4x200 mm	1262
2	screwdrivers for cross head Phillips® screws, extra - short series ● PH1x30 - PH2x30 mm	1262N
7	drivers for Torx® head screws ○ T6 - T8 - T10 - T15 - T20 - T25 - T30	1267TX
2	engineer's hammer 300 - 600 g	1370
2	soft face hammer Ø 35 - 60 mm	1390
5	tapered extractors M3+M18	1430/S5
1	two - leg universal puller 23+70 mm	1500N/1
1	two - leg universal puller 23+100 mm	1500N/2
1	sliding gauge	1650
1	semirigid stainless steel rule 300 mm	1683
1	engineer's scriber	1688A
1	measuring tape 5 m	1692
1	metric feeler gauge	1708/13
1	flexible magnetic pick-up tool 1,8 kg	1712E/2
5	second cut files 200 mm	1719BMA8/S5
1	hacksaw frame, aluminium handle	1726BM
1	riveting pliers	1741B
1	metal oil can 200 cc	1751

Beta N.

Industrial maintenance



Quantity/Description

16	combination wrenches 6+21 mm
5	combination wrenches 22 - 24 - 27 - 30 - 32 mm
5	pin punches Ø 2 - 3 - 4 - 5 - 6 mm
1	centre punch Ø 4 mm
13	double open end wrenches 6x7 - 8x9 - 10x11 - 12x13 - 14x15 - 16x17 - 18x19 - 20x22 - 21x23 - 24x26 - 27x29 - 30x32 mm
9	offset hexagon key wrenches Ø 1,5 - 2 - 2,5 - 3 - 4 - 5 - 6 - 8 - 10 mm
5	double ended offset ring wrenches 20x22 - 21x23 - 24x26 - 25x28 - 27x29 mm
7	double ended offset ring wrenches 6x7 - 8x9 - 10x11 - 12x13 - 14x15 - 16x17 - 18x19 mm
5	1/2" drive, socket drivers for hexagon screws Ø 5 - 6 - 8 - 10 - 12 mm
1	1/2" drive extension bar 125 mm
1	1/2" drive extension bar 255 mm
1	1/2" drive universal joint
1	1/2" drive sliding T-handle
1	1/2" drive reversible ratchet Ⓞ
19	1/2" square drive hexagon sockets Ø 10+24 - 26 - 27 - 30 - 32 mm
9	screwdrivers for cross head Phillips® screws ● 3x75 - 3x100 - 4x100 - 4x150 - 5,5x100 - 5,5x150 - 6,5x150 - 8x150 - 10x200 mm
2	screwdrivers for slotted head screws, extra-short series ● 4x30 - 6,5x30 mm
7	screwdrivers for cross head Phillips® screws ● PH0x60 - PH0x100 - PH1x80 - PH1x120 - PH2x100 - PH2x150 - PH3x150 mm
2	screwdrivers for cross head Phillips® screws, extra - short series ● PH1x30 - PH2x30 mm
4	offset hexagon key wrenches Ø 13-14-17-19 mm
1	tin snips 250 mm
1	electrician's scissors, straight blades
1	hacksaw frame, aluminium handle
(5)	blades for hacksaw
1	plastic oil can 200 cc
1	half-round needle nose pliers ≡ 180 mm
1	Extra-long needle nose pliers ● 160 mm
1	Heavy-duty diagonal cutting nippers ⚡ 160 mm
1	circclip pliers straight, internal ○ 180 mm
1	circclip pliers bent, internal ○ 170 mm

Beta N.

42NEW
42NEW
31
32
55
96N/SC9
90
90
920ME
920/21
920/22
920/25
920/42
920/55
920A
1260
1260N
1262
1262N
96N
1112
1128BM
1726
1728BM
1753
1150BM
1166BM
1084BM
1032
1034

Quantity/Description

1	circclip pliers straight, external ● 175mm
1	circclip pliers bent, external ● 175mm
2	flat chisels, ribbed type 100 - 200 mm
1	engineer's hammer 300 g
1	soft face hammer Ø 35 mm
1	second cut files 200 mm
4	combination wrenches 35-36-38-41 mm
1	double open end wrenches 36x41 mm
1	adjustable wrench 250 mm
1	heavy duty pipe wrench 300 mm
25	twist drills with cylindrical shanks, short series
37	assortment of HSS taps and dies, metric thread
1	click-type torque wrenches with reversible ratchets @ 200 Nm
17	assortment of 12 sockets and 5 accessories 3/4"
14	T-handle wrenches with hexagon male ends
5	T handle wrenches with swivelling hexagon male ends Ø 3-4-5-6-8 mm
1	circclip pliers straight, internal ○ 300 mm
1	circclip pliers bent, internal ○ 290 mm
1	circclip pliers straight, external ● 225 mm
1	circclip pliers bent, external ● 220 mm
1	Slip joint pliers boxed joints 300 mm
1	self locking pliers, double adjustment
1	toggle lever assisted end cutting nippers ⚡ 180 mm
1	engineer's hammer 600 g
1	soft face hammer 60 mm
5	tapered extractors M3-M18
1	two - leg universal puller
1	sliding gauge
1	semirigid stainless steel rule
1	engineer's scriber
1	measuring tape 5 m
1	metric feeler gauge
1	flexible magnetic pick-up tool

Beta N.

1036
1038
35
1370
1390
1719BMA8/S5
42
55
111
362
412/SP25
447/C37
666N/20
928A/C12
951/S14
953
1032
1034
1036
1038
1048
1051
1092V
1370
1390
1430/S5
1500/3
1650
1683
1688
1692
1708/13
1712E/2

Industrial maintenance



MB12



MB37



MB44



MB55

Quantity/Description

21	combination wrenches 6-7-8-9-10-11-12-13-14-15-16-17-18-19-20-21-22-24-27-30-32 mm	42NEW	MB12
8	double open end wrenches 6x7-8x9-10x11-12x13-14x15-16x17-18x19-20x22 mm	55	MB12
1	Slip joint pliers boxed joints 250 mm	1048	MB12
19	1/2" square drive hexagon sockets 10-11-12-13-14-15-16-17-18-19-20-21-22-23-24-26-27-30-32 mm	920A	MB37
1	1/2" wobble extension bar 125 mm	920AN/125	MB37
1	1/2" wobble extension bar 150 mm	920AN/250	MB37
1	1/2" drive universal joint	920/25	MB37
1	1/2" drive sliding T-handle	920/42	MB37
1	1/2" drive reversible ratchet	920/55	MB37
1	adjustable wrench 250 mm	111	MB37
1	self-locking pliers 240 mm	1052	MB37
1	Heavy-duty diagonal cutting nippers 160 mm	1084BM	MB37
1	half-round needle nose pliers 180 mm	1150BM	MB37
1	Extra-long needle nose pliers 160 mm	1166BM	MB37
1	circlip pliers straight, internal 180 mm	1032	MB37
1	circlip pliers bent, internal 170 mm	1034	MB37
1	circlip pliers straight, external 175 mm	1036	MB37
1	circlip pliers bent, external 175 mm	1038	MB37
13	1/4" hexagon sockets 4-4,5-5-5,5-6-7-8-9-10-11-12-13-14 mm	900	MB37
1	1/4" drive extension bar 50 mm	900/20	MB37
1	1/4" drive extension bar 150 mm	900/21	MB37
1	1/4" drive universal joint	900/25	MB37
1	1/4" drive spinner handle	900BG/30	MB37
1	1/4" reversible ratchet	900/55	MB37

Beta N.

TR

Quantity/Description

1	1/4" drive swivel T-handle	900/42	MB37
7	screwdrivers for cross head Phillips® screws 2,5x50-3x75-3,5x100-4x100-5,5x125-6,5x150-8x200 mm	1260N	MB44
2	screwdrivers for slotted head screws, extra-short series 4x30-6,5x30 mm	1262N	MB44
7	screwdrivers for cross head Phillips® screws PH0x60-PH0x100-PH1x80-PH1x120-PH2x100-PH2x150-PH3x150 mm	1262N	MB44
2	screwdrivers for cross head Phillips® screws, extra - short series PH1x30-PH2x30 mm	1253	MB44
1	mains testing screwdriver 4x30-6,5x30 mm	96BPC/SC9	MB44
9	ball head offset hexagon key wrenches 2,5-3-4-5-6-8 mm	951	MB44
6	T-handle wrenches with hexagon male ends 2,5-3-4-5-6-8 mm	31	MB55
5	pin punches 2-3-4-5-6 mm	32	MB55
1	centre punch 4 mm	35	MB55
1	flat chisels, ribbed type 200 mm	1112	MB55
1	tin snips 250 mm	1128BMX	MB55
1	electrician's scissors, straight blades	1370	MB55
1	engineer's hammer 500 g	1390	MB55
1	soft face hammer 45 mm	1719BMA...Q	MB55
1	second-cut square files 200 mm	1719BMA...T	MB55
1	second-cut triangular files 200 mm	1719BMA...P	MB55
1	second-cut flat files 200 mm	1719BMA...M	MB55
1	second-cut half-round files 200 mm	1719BMA...R	MB55
1	second-cut round files 200 mm	1726	MB55
1	hacksaw frame, aluminium handle 440 mm		

Beta N.

TR

Industrial maintenance



17 kg

Quantity/Description

- 5 pin punches Ø 2-3-4-5-6 mm
- 1 centre punch Ø 4 mm
- 2 flat chisels, ribbed type 200-250 mm
- 18 combination wrenches
6÷14 - 16 - 17 - 18 - 19 - 21 - 22 - 24 - 27 - 30 mm
- 12 double open end wrenches 6x7 - 8x9 - 10x11 - 12x13 - 14x15 - 16x17
18x19 - 20x22 - 21x23 - 24x26 - 27x29 - 30x32 mm
- 12 offset hexagon key wrenches Ø 2÷10 mm
- 1 adjustable wrench 250 mm
- 1 pipe wrench Swedish pattern 320 mm
- 20 1/2" square drive hexagon sockets Ø 10÷24 - 26 - 27 - 28 - 30 - 32 mm
- 6 1/2" drive, socket drivers for hexagon screws
Ø 5 - 6 - 8 - 10 - 12 - 14 mm
- 1 1/2" drive extension bar 125 mm
- 1 1/2" drive extension bar 255 mm
- 1 1/2" drive universal joint
- 1 1/2" drive swivel T-handle
- 1 1/2" drive sliding T-handle
- 1 1/2" drive reversible ratchet
- 6 T-handle wrenches with hexagon male ends Ø 2,5 - 3 - 4 - 5 - 6 - 8 mm
- 2 circlip pliers straight, internal Ø 140 - 180 mm
- 1 circlip pliers bent, internal Ø 170 mm
- 2 circlip pliers straight, external Ø 140x1,3 - 175 mm
- 1 circlip pliers bent, external Ø 175 mm
- 1 Slip joint pliers boxed joints 250 mm

Beta N.

- 31
- 32
- 35
- 42NEW
- 55
- 96/SC12
- 111
- 374
- 920A
- 920ME
- 920/21
- 920/22
- 920/25
- 920/40
- 920/42
- 920/55
- 951
- 1032
- 1034
- 1036
- 1038
- 1048

Quantity/Description

- 1 self - locking pliers 240 mm
- 1 Heavy-duty diagonal cutting nippers ≤ 160 mm
- 1 toggle lever assisted end cutting nippers ≤ 180 mm
- 1 tin snips 250 mm
- 1 electrician's scissors, straight blades
- 1 half-round needle nose pliers = 180 mm
- 1 Extra-long needle nose pliers ● 160 mm
- 1 mains testing screwdriver ●
- 2 screwdrivers for cross head Phillips® screws ● 8x150 - 10x200 mm
- 2 screwdrivers for slotted head screws, extra-short series ● 4x30 - 6,5x30 mm
- 2 screwdrivers for cross head Phillips® screws ⚙ PH3x150 - PH4x200 mm
- 2 screwdrivers for cross head Phillips® screws, extra - short series ⚙ PH1x30 - PH2x30 mm
- 8 set of screwdrivers
- 2 engineer's hammer 300 - 500 g
- 1 soft face hammer Ø 45 mm
- 1 measuring tape 5 m
- 1 flexible magnetic pick-up tool 0,5 kg
- 5 second cut files 200 mm
- 1 hacksaw frame, aluminium handle
- 1 plastic oil can 250 cc

Beta N.

- 1052
- 1084BM
- 1092V
- 1112
- 1128BMX
- 1150BM
- 1166BM
- 1253
- 1260
- 1260N
- 1262
- 1262N
- 1263/D8
- 1370
- 1390
- 1692
- 1712E/1
- 1719BMA8/S5
- 1726BM
- 1754

5954VI

059541053

Assortment recommended in combination with C54S-C55C

Industrial maintenance



32 kg

Quantity/Description

6	pin punches Ø 2 - 3 - 4 - 5 - 6 - 8 mm
6	2 drift punches, 1 centre punch, 3 flat chisels with metal holder
18	combination wrenches 6-7-8-10-11-12-13-14-15-16-17-19-21-22-24-27-30-32 mm
12	double open end wrenches 6x7 + 30x32 mm
8	offset hexagon key wrenches 2 - 2,5 - 3 - 4 - 5 - 6 - 8 - 10 mm
8	offset key wrenches, for Torx® head screws ⌘ T9 - T10 - T15 - T20 - T25 - T27 - T30 - T40
1	adjustable wrench 250 mm
13	1/2" square drive bi-hex sockets with rail ○ 10+22 mm
8	1/2" square drive bi-hex sockets with rail ○ 23+32 mm
4	1/2" socket drivers for slotted head screws ● 1,2x6,5 - 1,2x8 - 1,6x9 - 2x12 mm
3	1/2" socket drivers for Phillips® screws ⦿ PH2 - 3 - 4
1	1/2" drive extension bar 125 mm
1	1/2" drive extension bar 255 mm
1	1/2" drive universal joint
1	1/2" drive sliding T-handle
1	1/2" drive reversible ratchet ⌚
1	pry bar
2	circlip pliers straight, internal ⊙ 140 - 180 mm
2	circlip pliers bent, internal ⊙ 130 - 170 mm
2	circlip pliers straight, external ● 140 - 175 mm
2	circlip pliers bent, external ● 135 - 175 mm
1	Slip joint pliers boxed joints 250 mm
1	self locking pliers, double adjustment
1	Heavy-duty diagonal cutting nippers ⚡ 160 mm
1	toggle lever assisted end cutting nippers ⚡ 180 mm
1	tin snips 250 mm

Beta N.

31/SP6
38/SP6
42NEW
55/S12X
96T/S8
97TX/SC8
111
920B/SB13
920B/SB8
920LP
920PH
920/21
920/22
920/25
920/42
920/55
963
1032
1034
1036
1038
1048
1051
1084BM
1092V
1112

Quantity/Description

1	tin snip, straight narrow blades 250 mm	1114
1	electrician's scissors, straight blades	1128BMX
1	half-round needle nose pliers ≡ 180 mm	1150BM
1	Extra-long needle nose pliers ● 160 mm	1166BM
1	Extra-long bent needle nose pliers ● 160 mm	1168BM
7	screwdrivers for cross head Phillips® screws ● 2,5x50 - 3x75 - 4x100 - 5,5x125 - 6,5x150 - 8x200 - 10x200 mm	1260
4	screwdrivers for cross head Phillips® screws ⦿ PH0x60 - PH1x80 - PH2x100 - PH3x150 mm	1262
3	engineer's hammer 300 - 600 - 1000 g	1370
1	soft face hammer Ø 35 mm	1390
1	measuring tape 5 m	1692
1	flexible magnetic pick-up tool 1,8 kg	1712E/2
1	two cutting edges scraper 200 mm	1717A
1	three - cutting edges scraper 200 mm	1717B
5	second cut files 200 mm	1719BMA8/S5
1	hacksaw frame, aluminium handle	1725
1	metal oil can 200 cc	1751
1	flat chisels, ribbed type 200 mm	35
1	cape chisel, ribbed type 200 mm	37
11	double ended hexagon/bi - hex offset socket wrenches 8 - 10 - 11 - 12 - 13 - 14 - 16 - 17 - 19 - 22 - 24 mm	932
1	self - locking pliers 240 mm	1052
1	self - locking pliers 280 mm	1060
1	self - locking pliers 290 mm	1062
1	dead blow hammer Ø 50 mm	1392
1	two - leg universal puller 25+130 mm	1500N/2
1	sliding gauge	1650
1	semirigid stainless steel rule 300 mm	1683
1	engineer's scriber	1688A
1	metric feeler gauge	1708/13
1	fold - away knife	1777BM
1	snap - off blade utility knife 170 mm	1771BM
1	Diagonal cutting nippers ⚡ 160 mm	1082BM

5957VI

059571005

Assortment recommended in combination with C57S A - C57S B - C57SP - C55PSP

5904VU/1M

assortment of 91 tools in EVA foam trays

Universal use



M05



M50



M137

M153

M234

M145

Quantity/Description

- 16 combination wrenches 6+21 mm
- 8 double open end wrenches 6x7 - 8x9 - 10x11 - 12x13 - 14x15 - 16x17 - 18x19 - 20x22 mm
- 9 offset hexagon key wrenches \odot 1,5 - 2 - 2,5 - 3 - 4 - 5 - 6 - 8 - 10 mm
- 7 screwdrivers for cross head Phillips® screws \bullet 2,5x50 - 3x75 - 3,5x100 - 4x125 - 5,5x100 - 5,5x150 - 6,5x150 mm
- 6 screwdrivers for cross head Phillips® screws \oplus PH0x60 - PH0x100 - PH1x80 - PH1x120 - PH2x100 - PH2x150 mm
- 8 offset hexagon key wrenches \odot 2-2,5-3-4-5-6-7-8 mm
- 1 1/2" wobble extension bar 125 mm
- 1 1/2" wobble extension bar 250 mm
- 1 1/2" drive universal joint
- 1 1/2" drive sliding T-handle
- 1 1/2" drive reversible ratchet \oplus
- 19 1/2" square drive hexagon sockets \odot 10+24 - 26 - 27 - 30 - 32 mm

Beta N.	TR
42NEW	M05
55	M33
96/SC9	M33
1260	M199
1262	M202
96T	M50
920AN/125	M83
920AN/250	M83
920/25	M83
920/42	M83
920/55	M83
920A	M83

Quantity/Description

- 1 Heavy-duty diagonal cutting nippers \llcorner 160 mm
- 1 half-round needle nose pliers \equiv 180 mm
- 1 Extra-long needle nose pliers \bullet 160 mm
- 1 Slip joint pliers boxed joints 250 mm
- 1 self-locking pliers 240 mm
- 2 flat chisels, ribbed type 100 - 200 mm
- 1 engineer's hammer 300 g
- 1 soft face hammer \varnothing 35 mm
- 1 circlip pliers straight, internal \odot 180 mm
- 1 circlip pliers bent, internal \odot 170 mm
- 1 circlip pliers straight, external \bullet 175 mm
- 1 circlip pliers bent, external \bullet 175 mm

Beta N.	TR
1084	M137
1150	M137
1166	M137
1048	M153
1052	M153
35	M234
1370	M234
1390	M234
1032	M145
1034	M145
1036	M145
1038	M145

5904VU/1M

059041201

Assortment recommended in combination with C24S - C24SA - C24SA-XL - C37 - C39 with 6 - 7 - 8 drawers
C23ST - C39T - C24SL - C24SL/CAB - C59 - C55 - C28 - C39SM - C39MD

Universal use



M05 M33 M199 M202



M50 M83



M137 M153 M237 M145



M204 M289 M85 M236

Quantity/Description

16	combination wrenches 6÷21 mm
8	double open end wrenches 6x7 - 8x9 - 10x11 - 12x13 - 14x15 - 16x17
	18x19 - 20x22 mm
9	offset hexagon key wrenches \odot 1,5 - 2 - 2,5 - 3 - 4 - 5 - 6 - 8 - 10 mm
7	screwdrivers for cross head Phillips® screws \bullet 2,5x50 - 3x75 - 3,5x100 - 4x125 - 5,5x100 - 5,5x150 - 6,5x150 mm
6	screwdrivers for cross head Phillips® screws \oplus PH0x60 - PH0x100 - PH1x80 - PH1x120 - PH2x100 - PH2x150 mm
8	offset hexagon key wrenches \odot 2-2,5-3-4-5-6-7-8 mm
1	1/2" wobble extension bar 125 mm
1	1/2" wobble extension bar 250 mm
1	1/2" drive universal joint
1	1/2" drive sliding T-handle
1	1/2" drive reversible ratchet \oplus
19	1/2" square drive hexagon sockets \odot 10÷24 - 26 - 27 - 30 - 32 mm
1	Heavy-duty diagonal cutting nippers \sphericalangle 160 mm
1	half-round needle nose pliers \equiv 180 mm
1	Extra-long needle nose pliers \bullet 160 mm
1	Slip joint pliers boxed joints 250 mm
1	self - locking pliers 240 mm
2	flat chisels, ribbed type 100 - 200 mm
1	mechanic's hammers 300 g
1	nylon face hammers, wooden shafts \varnothing 35 mm
1	circlip pliers straight, internal \odot 180 mm

Beta N.

TR

42NEW	M05
55	M33
96/SC9	M33
1260	M199
1262	M202
96T	M50
920AN/125	M83
920AN/250	M83
920/25	M83
920/42	M83
920/55	M83
920A	M83
1084	M137
1150	M137
1166	M137
1048	M153
1052	M153
35	M237
1370T	M237
1390N	M237
1032	M145

Quantity/Description

1	circlip pliers bent, internal \odot 170 mm
1	circlip pliers straight, external \bullet 175 mm
1	circlip pliers bent, external \bullet 175 mm
6	drivers for Torx® head screws \odot T8-T10-T15-T20-T25-T30
1	measuring tape 5 m
1	mini hacksaw frame
1	plastic oil bottle 30 cc
1	snap - off blade utility knife
5	bits for slotted head screws, coloured \bullet 0,5x3 - 0,6x4,5 - 0,8x5,5 - 1x5,5 - 1,2x6,5 mm
8	hexagon bits for power drivers, coloured \odot 2 - 2,5 - 3 - 4 - 5 - 6 - 8 - 10 mm
5	bits for cross head Phillips® screws, coloured \oplus PH0 - PH1 - PH2 - PH3 - PH4
4	bits for cross head Pozidriv® - Supadriv® screws, coloured \oplus PZ1 - PZ2 - PZ3 - PZ4
11	bits for Torx® head screws, coloured \odot T6-T7-T8-T9-T10-T15-T20-T25-T27-T30-T40
8	bits for Tamper Resistant Torx® head screws, coloured \oplus T9-T10-T15-T20-T25-T27-T30-T40
1	magnetic bit holder with handle 230 mm
1	reversible bit ratchet 100 mm
5	second cut files 200 mm
1	adaptors for drivers
1	magnetic bit holder extension bar

Beta N.

TR

1034	M145
1036	M145
1038	M145
1267TX	M204
1692	M289
1725CR	M289
1755	M289
1771	M289
860LP	M85
860PE	M85
860PH	M85
860PZ	M85
860TX	M85
860RTX	M85
851SR	M85
860/55	M85
1719BMA8/	M236
S5	
892/0	M85
882P	M85

5904VU/2T

assortment of 104 tools in ABS thermoformed trays

Universal use



T199

T202

T83



T145

T153

T138

T234

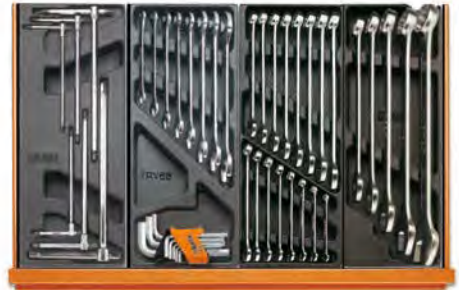

T68

T33

T05

T06



T284

Quantity/Description

- 7 screwdrivers for cross head Phillips® screws ● 2,5x50 - 3x75 - 3,5x100 - 4x125 - 5,5x100 - 5,5x150 - 6,5x150 mm
- 6 screwdrivers for cross head Phillips® screws ◐ PH0x60 - PH0x100 - PH1x80 - PH1x120 - PH2x100 - PH2x150 mm
- 19 1/2" square drive hexagon sockets ○ 10-11-12-13-14-15-16-17-18-19 - 20-21-22-23-24-26-27-30-32 mm
- 1 1/2" drive extension bar 125 mm
- 1 1/2" drive extension bar 255 mm
- 1 1/2" drive universal joint
- 1 1/2" drive sliding T-handle 305 mm
- 1 1/2" drive reversible ratchet ⊕
- 1 circlip pliers straight, internal ○ 180 mm
- 1 circlip pliers bent, internal ○ 170 mm
- 1 circlip pliers straight, external ● 175 mm
- 1 circlip pliers bent, external ● 175 mm
- 1 Slip joint pliers boxed joints 250 mm
- 1 self - locking pliers 240 mm
- 1 Heavy-duty diagonal cutting nippers ✂ 160 mm
- 1 half-round needle nose pliers = 180 mm
- 1 Extra-long needle nose pliers ● 160 mm

Beta N. TR

- 1260 T199
- 1262 T202
- 920A T83
- 920/21 T83
- 920/22 T83
- 920/25 T83
- 920/42 T83
- 920/55 T83
- 1032 T145
- 1034 T145
- 1036 T145
- 1038 T145
- 1048 T153
- 1052 T153
- 1084 T138
- 1150 T138
- 1166 T138

Quantity/Description

- 2 flat chisels, ribbed type 100-200 mm
- 1 engineer's hammer 300 g
- 1 soft face hammer Ø 35 mm
- 6 T-handle wrenches with hexagon male ends ○ 2,5-3-4-5-6-8 mm
- 8 double open end wrenches 6x7-8x9-10x11-12x13-14x15-16x17-18x19-20x22 mm
- 9 offset hexagon key wrenches ○ 1,5÷10 mm
- 16 combination wrenches 6-7-8-9-10-11-12-13-14-15-16-17-18-19-20-21 mm
- 5 combination wrenches 22-24-27-30-32 mm
- 1 electrician's scissors, straight blades
- 1 Multiuse scissors
- 1 second-cut square files 200 mm
- 1 second-cut flat files 200 mm
- 1 second-cut triangular files 200 mm
- 1 second-cut half-round files 200 mm
- 1 second-cut round files 200 mm
- 1 hacksaw frame, aluminium handle
- 1 blades for hacksaw
- 1 snap - off blade utility knife 170 mm
- 1 foldaway knife 185 mm

Beta N. TR

- 35 T234
- 1370 T234
- 1390 T234
- 951 T68
- 55 T33
- 96/SC9 T33
- 42NEW T05
- 42NEW T06
- 1128BMX T284
- 1130BMX T284
- 1719BMA...Q T284
- 1719BMA...P T284
- 1719BMA...T T284
- 1719BMA...M T284
- 1719BMA...R T284
- 1726BM T284
- 1728BM T284
- 1771BM T284
- 1778 T284

5904VU/2T

059041070

Assortment recommended in combination with C24S - C24SA - C37 - C39 C24SL - C24SL/CAB - C59 - C55 - C23ST - C28 - C39SM - C39MD - C39T

5904VU/3T

assortment of 146 tools in ABS thermoformed trays

Universal use



T05



T06



T31



T52



T55



T80



T91



T145



T138



T153



T198



T205



T234



T236

Quantity/Description

16	combination wrenches 6÷21 mm
5	combination wrenches 22 - 24 - 27 - 30 - 32 mm
5	pin punches Ø 2 - 3 - 4 - 5 - 6 mm
1	centre punch Ø 4 mm
12	double open end wrenches 6x7 - 8x9 - 10x11 - 12x13 - 14x15 - 16x17 - 18x19 - 20x22 - 21x23 - 24x26 - 27x29 - 30x32 mm
9	offset hexagon key wrenches Ø 1,5 - 2 - 2,5 - 3 - 4 - 5 - 6 - 8 - 10 mm
6	offset hexagon key wrenches Ø 2 - 2,5 - 3 - 4 - 5 - 6 mm
6	drivers for Torx® head screws, with handles T10-T15-T20-T25-T27-T30
5	1/2" drive, socket drivers for hexagon screws Ø 5 - 6 - 8 - 10 - 12 mm
1	1/2" drive extension bar 125 mm
1	1/2" drive extension bar 255 mm
1	1/2" drive universal joint
1	1/2" drive sliding T-handle
1	1/2" drive reversible ratchet
19	1/2" square drive hexagon sockets Ø 10÷24 - 26 - 27 - 30 - 32 mm
13	1/4" hexagon sockets Ø 4-4,5-5-5,5-6-7-8-9-10-11-12-13-14 mm
6	1/4" socket drivers for hexagon screws Ø 2,5-3-4-5-6-8 mm
1	1/4" drive extension bar 50 mm
1	1/4" drive extension bar 150 mm
1	1/4" drive universal joint
1	1/4" drive spinner handle
1	1/4" drive swivel T-handle 115 mm

Beta N.	TR
42NEW	T05
42NEW	T06
31	T31
32	T31
55	T31
96N/SC9	T31
96T	T52
97TTX	T55
920ME	T80
920/21	T80
920/22	T80
920/25	T80
920/42	T80
920/55	T80
920A	T80
900	T91
900ME	T91
900/20	T91
900/21	T91
900/25	T91
900BG/30	T91
900/42	T91

Quantity/Description

1	1/4" reversible ratchet
1	circlip pliers straight, internal Ø 180 mm
1	circlip pliers bent, internal Ø 170 mm
1	circlip pliers straight, external Ø 175 mm
1	circlip pliers bent, external Ø 175 mm
1	half-round needle nose pliers 180 mm
1	Extra-long needle nose pliers 160 mm
1	Heavy-duty diagonal cutting nippers 160 mm
1	Slip joint pliers boxed joints 250 mm
1	self - locking pliers 240 mm
4	screwdrivers for cross head Phillips® screws 3x75 - 4x100 - 5,5x150 - 6,5x150 mm
3	screwdrivers for cross head Pozidriv®-Supadriv® screws PZ0 - PZ1 - PZ2
7	drivers for Torx® head screws T6-T7-T8-T9-T10-T15-T20
2	flat chisels, ribbed type 100 - 200 mm
1	engineer's hammer 300 g
1	soft face hammer Ø 35 mm
5	second cut files 200 mm

Beta N.	TR
900/55	T91
1032	T145
1034	T145
1036	T145
1038	T145
1150	T138
1166	T138
1084	T138
1048	T153
1052	T153
1260	T198
1269PZ	T198
1267TX	T205
35	T234
1370	T234
1390	T234
1719BMA8/S5	T236

5904VU/3T

059041203

Assortment recommended in combination with C24S - C24SA - C37 - C39 C24SL - C24SL/CAB - C59 - C55 - C39T - C39SM - C39MD - C23ST - C28

Universal use



T01



T91

T156

T40

T211



T213

T216

T234

T259



Quantity/Description

- 1 drift punches Ø 4 mm
- 1 pin punches Ø 4 mm
- 1 centre punch Ø 4 mm
- 54 assortment of 52 hexagon bits, 10 mm, and 2 accessories
- 17 combination wrenches 6-7-8-10-11-12-13
14-16-17-18-19-21
22-24-27-30 mm
- 7 double ended offset ring wrenches 6x7-8x9-10x11
12x13-14x15
16x17-18x19 mm
- 19 1/2" square drive hexagon sockets ○ 10-11-12-13-14-15-16-
17-18-19-20-21-22-23-24-26-27-30-32 mm
- 1 1/2" drive extension bar 125 mm
- 1 1/2" drive extension bar 250 mm
- 1 1/2" drive universal joint
- 1 1/2" drive sliding T-handle 305 mm
- 1 1/2" drive reversible ratchet ⊕
- 13 1/4" hexagon sockets ○ 4-4,5-5-5,5-6
7-8-9-10-11
12-13-14 mm
- 6 1/4" socket drivers for hexagon screws ○ 2,5-3-4-5-6-8 mm
- 1 1/4" drive extension bar 50 mm

Beta N.	TR
30	
31	
32	
867/C52	
42NEW	T01
90	T40
920A	T83
920/21	T83
920/22	T83
920/25	T83
920/42	T83
920/55	T83
900	T91
900ME	T91
900/20	T91

Quantity/Description

- 1 1/4" drive extension bar 150 mm
- 1 1/4" drive universal joint
- 1 1/4" drive spinner handle
- 1 1/4" drive swivel T-handle 115 mm
- 1 1/4" reversible ratchet ⊕
- 1 Diagonal cutting nippers ✂ 160 mm
- 1 half-round needle nose pliers = 180 mm
- 1 Slip joint pliers boxed joints 250 mm
- 7 screwdriver for slotted head screws ● 2,5x50 - 3x75 - 3,5x100
- 4x125 - 5,5x100 - 5,5x150 - 6,5x150 mm
- 6 screwdriver for cross head Phillips® screws ⊕ PH0x60 -
PH1x80 - PH1x120 - PH2x100 - PH2x150 - PH3x150 mm
- 7 screwdrivers for Torx® head screws, with handles ○ T6-T7-T8-
T9-T10-T15-T20
- 2 flat chisels, ribbed type 100-200 mm
- 1 engineer's hammer 300 g
- 1 soft face hammer Ø 35 mm
- 7 ball head offset hexagon key wrenches burnished ○ 2,5-3-4-
5-6-8-10 mm
- 1 offset hexagon key wrenches ○ 12 mm
- 31 bits with magnetic quick release bit holder in plastic case ●
○ ⊕ ⊕ ⊕ ⊕
- 1 socket holder

Beta N.	TR
900/21	T91
900/25	T91
900BG/30	T91
900/42	T91
900/55	T91
1082	T156
1150	T156
1048	T156
1201E	T211
1202E	T213
1207E/TX	T216
35	T234
1370	T234
1390	T234
96BP	T259
96N	T259
860MIX/A31	T259
895/1	T259

5904VU/4T

059241100

Assortment recommended in combination with items C23ST - C24S - C24SA - C24SA-XL - C24SL - C24SL/CAB - C37
- C39 - C39T - C39SM - C39MD - RSC55 - C59

Universal use



T05



T40



T82



T145



T234

Quantity/Description

Beta N. TR

16	combination wrenches 6÷21 mm	42NEW	T05
5	combination wrenches 22 - 24 - 27 - 30 - 32 mm	42NEW	T06
5	pin punches Ø 2 - 3 - 4 - 5 - 6 mm	31	T31
1	centre punch Ø 4 mm	32	T31
12	double open end wrenches 6x7 - 8x9 - 10x11 - 12x13 - 14x15 - 16x17 - 18x19 - 20x22 - 21x23 - 24x26 - 27x29 - 30x32 mm	55	T31
9	offset hexagon key wrenches Ø 1,5 - 2 - 2,5 - 3 - 4 - 5 - 6 - 8 - 10 mm	96N/SC9	T31
7	double ended offset ring wrenches 6x7-8x9-10x11-12x13-14x15-16x17-18x19 mm	90	T40
6	offset hexagon key wrenches Ø 2-2,5-3-4-5-6 mm	96T	T52
6	drivers for Torx® head screws, with handles Ø T10-T15-T20-T25-T27-T30	97TTX	T55
19	1/2" square drive hexagon sockets Ø 10-11-12-13-14-15-16-17-18-19-20-21-22-23-24-26-27-30-32 mm	920A	T82
5	1/2" drive, socket drivers for hexagon screws Ø 5-6-8-10-12 mm	920ME	T82
1	1/2" wobble extension bar 125 mm	920AN/125	T82
1	1/2" wobble extension bar 250 mm	920AN/250	T82
1	1/2" drive universal joint	920/25	T82
1	1/2" drive sliding T-handle 305 mm	920/42	T82
1	1/2" drive reversible ratchet	920/55	T82
13	1/4" hexagon sockets Ø 4-4,5-5-5,5-6-7-8-9-10-11-12-13-14 mm	900	T91
6	1/4" socket drivers for hexagon screws Ø 2,5-3-4-5-6-8 mm	900ME	T91
1	1/4" drive extension bar 50 mm	900/20	T91
1	1/4" drive extension bar 150 mm	900/21	T91
1	1/4" drive universal joint	900/25	T91
1	1/4" drive spinner handle	900BG/30	T91
1	1/4" drive swivel T-handle 115 mm	900/42	T91
1	1/4" reversible ratchet	900/55	T91
1	Heavy-duty diagonal cutting nippers < 160 mm	1084	T138
1	half-round needle nose pliers = 180 mm	1150	T138
1	Extra-long needle nose pliers • 160 mm	1166	T138

Quantity/Description

Beta N. TR

1	circlip pliers straight, internal Ø 180 mm	1032	T145
1	circlip pliers bent, internal Ø 170 mm	1034	T145
1	circlip pliers straight, external • 175 mm	1036	T145
1	circlip pliers bent, external • 175 mm	1038	T145
1	Slip joint pliers boxed joints 250 mm	1048	T153
1	self - locking pliers 240 mm	1052	T153
7	screwdrivers for cross head Phillips® screws • 2,5x50-3x75-3,5x100-4x125-5,5x100-5,5x150-6,5x150 mm	1290	T170
3	screwdrivers for cross head Phillips® screws • 8x150-8x200-10x200 mm	1290	T171
2	screwdriver for slotted head screws, extra-short series • 4x30-6,5x30 mm	1290N	T171
6	screwdrivers for cross head Phillips® screws • PH0x60-PH0x100-PH1x80-PH1x120-PH2x100-PH2x150 mm	1292	T172
2	screwdrivers for cross head Phillips® screws • PH3x150-PH4x200 mm	1292	T173
2	screwdriver for cross head Phillips® screws, extra-short series • PH1x30-PH2x30 mm	1292N	T173
2	flat chisels, ribbed type 100-200 mm	35	T234
1	engineer's hammer 300 g	1370	T234
1	soft face hammer Ø 35 mm	1390	T234
1	second-cut square files 200 mm	1719BMA...Q	T236
1	second-cut triangular files 200 mm	1719BMA...T	T236
1	second-cut flat files 200 mm	1719BMA...P	T236
1	second-cut half-round files 200 mm	1719BMA...M	T236
1	second-cut round files 200 mm	1719BMA...R	T236
1			VP4

Universal use



MC T1



MC T2



MC T3

Quantity/Description

Quantity/Description	Beta N.	TR
31 bits with magnetic quick release bit holder in plastic case \bullet $\circ \oplus \oplus \oplus$	860MIX/A31	MCT1
1 socket holder	895/1	MCT1
13 1/4" hexagon sockets \circ 4-4,5-5,5-6-7-8-9-10-11-12-13-14 mm	900	MCT1
1 1/4" drive extension bar 150 mm	900/...	MCT1
1 1/4" drive universal joint	900/25	MCT1
1 1/4" drive spinner handle	900BG/30C	MCT1
1 1/4" drive swivel T-handle	900/42	MCT1
1 1/4" reversible ratchet \oplus	900/55	MCT1
16 1/2" square drive hexagon sockets \circ 10-11-12-13-14-15-16- 17-18-19-21-22-24-27-30-32 mm	920A	MCT1
1 1/2" drive universal joint	920/25	MCT1
1 1/2" wobble extension bar	920AN/125	MCT1
1 1/2" drive sliding T-handle	920/42	MCT1
1 1/2" drive reversible ratchet \oplus	920/55	MCT1
16 combination wrenches 6-7-8-9-10-11-12-13 14-15-16-17-18-19-21-22 mm	42NEW	MCT2

Quantity/Description

Quantity/Description	Beta N.	TR
9 offset hexagon key wrenches \circ	96/SC9	MCT2
1 adjustable wrench 250 mm	111	MCT2
1 electrician's scissors, straight blades	1128BMX	MCT2
1 measuring tape 5 mt	1692/5	MCT2
1 snap - off blade utility knife	1771	MCT2
1 Slip joint pliers boxed joints 250 mm	1048	MCT3
1 Diagonal cutting nippers ∇ 160 mm	1082BM	MCT3
1 half-round needle nose pliers \equiv 180 mm	1150BM	MCT3
1 Extra-long needle nose pliers \bullet 160 mm	1166BM	MCT3
3 screwdrivers for cross head Phillips® screws \bullet 3,5x100- 5,5x125-6,5x150 mm	1260	MCT3
3 screwdrivers for cross head Phillips® screws \oplus PHx60- PH1x80-PH3x100 mm	1262	MCT3

Universal use



M01

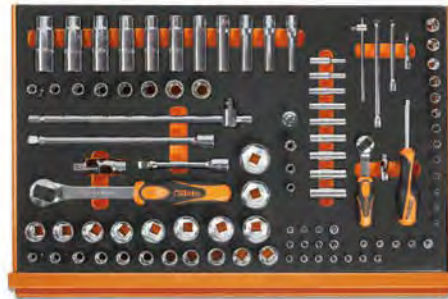

M100



M213



M33

M86

M136

M234

Quantity/Description	Beta N.	TR	Quantity/Description	Beta N.	TR
22 combination wrenches 6-7-8-9-10-11-12-13-14-15-16-17-18-19-20-21-22-24-27-30-32-36 mm	42NEW	M01	1 1/4" drive extension bar 150 mm	900/21	M100
8 double open end wrenches 6x7-8x9-10x11-12x13-14x15-16x17-18x19-20x22 mm	55	M33	1 1/4" drive universal joint	900/25	M100
9 offset hexagon key wrenches \odot 1,5÷10 mm	96/SC9	M33	1 1/4" drive spinner handle	900BG/30	M100
7 hexagon bits \odot 4-5-6-7-8-10-12 mm	867PE	M86	1 1/4" drive swivel T-handle	900/42	M100
7 hexagon bits \odot 4-5-6-7-8-10-12 mm	867PE/L	M86	1 1/4" reversible ratchet \oplus	900/55	M100
5 bits with XZN [®] profile \odot 5-6-8-10-12 mm	867XZN	M86	21 1/2" square drive hexagon sockets \odot 8-10-11-12-13-14-15-16-17-18-19-20	920A	M100
5 bits with XZN [®] profile \odot 5-6-8-10-12 mm	867XZN/L	M86	21-22-23-24-26-27-28-30-32 mm		
7 bits for Torx [®] head screws \oplus T20-T25-T30-T40-T45-T50-T55	867TX	M86	1 adaptor, 1/2" female and 3/8" male drives	920/15	M100
6 bits for Torx [®] head screws \oplus T25-T30-T40-T45-T50-T55	867TX/L	M86	1 1/2" drive universal joint	920/25	M100
7 bits for Tamper Resistant Torx [®] head screws \oplus T20-T25-T30-T40-T45-T50-T55	867RTX	M86	1 1/2" wobble extension bar 125 mm	920AN/125	M100
1 bit holder sockets for item 867	867/1	M86	1 1/2" wobble extension bar 250 mm	920AN/250	M100
1 bit holder sockets for item 867	867/2	M86	1 1/2" drive sliding T-handle	920/42	M100
1 socket holder	895/1	M100	1 1/2" drive reversible ratchet \oplus	920/55	M100
1 socket holder	895/3	M100	8 1/2" sockets for Torx [®] head screws \odot 10-12-14-16-18-20-22-24 mm	920FTX	M100
1 socket holder	895/6	M100	11 hexagon hand sockets \odot 10-12-13-14-15-16-17-18-19-21-22	920AL	M100
13 1/4" hexagon sockets \odot 4-4-5-5-5-5-6-7-8-9-10-11-12-13-14 mm	900	M100	1 Heavy-duty diagonal cutting nippers \ddagger 160 mm	1084BM	M136
9 hexagon hand sockets, long series \odot 5-6-7-8-9-10-11-12-13 mm	900L	M100	1 half-round needle nose pliers \equiv 180 mm	1150BM	M136
5 1/4" socket drivers for hexagon screws \odot 3-4-5-6-7 mm	900ME	M100	1 Extra-long needle nose pliers \bullet 160 mm	1166BM	M136
4 socket drivers for slotted head screws \bullet 0,8x4-1x5,5-1,2x6,5-1,2x8 mm	900LP	M100	6 screwdriver for slotted head screws \bullet 2,5x50-3x75-4x100-5,5x125-6,5x150-8x200 mm	1201E	M213
4 socket drivers for cross head Phillips [®] screws \oplus PH1-PH2-PH3-PH4	900PH	M100	1 screwdriver for slotted head screws, extra-short series \bullet 4x30 mm	1201EN	M213
7 socket drivers for Torx [®] head screws \oplus T10-T15-T20-T25-T27-T30-T40	900TX	M100	4 screwdriver for cross head Phillips [®] screws \oplus PH0x60-PH1x80-PH2x100-PH3x150 mm	1202E	M213
1 1/4" drive extension bar 50 mm	900/20	M100	1 screwdriver for cross head Phillips [®] screws, extra-short series \oplus PH1X30 mm	1202EN	M213
1 1/4" drive extension bar 100 mm	900/20L	M100	12 screwdrivers for Torx [®] head screws, with handles \oplus T6-T7-T8-T9-T10-T15-T20-T25-T27-T30-T40-T45	1207E/TX	M213
			1 mains testing screwdriver \bullet	1253	M213
			2 flat chisels, ribbed type 100-200 mm	35	M234
			1 engineer's hammer 300 g	1370	M234
			1 soft face hammer \varnothing 35 mm	1390	M234

Universal use



Quantity/Description

1	centre punch 4 mm	Beta N.	32
1	flat chisels, ribbed type 125 mm		35
8	double open end wrenches 6x7-8x9-10x11-12x13-14x15-16x17-18x19-20x22 mm		55
7	Offset hexagon key wrenches \odot 1,5-2-2,5-3-4-5-6 mm	96/BGS7	
1	adjustable wrench 150 mm		111
1	Slip joint pliers boxed joints 250 mm		1048
1	diagonal cutting nippers, slip-proof double layer PVC coated handles, industrial finish \nless 160 mm	1082G	
1	electrician's scissors, straight blades	1128BMX	
1	heavy duty combination pliers, slip-proof double layer PVC coated handles, industrial finish \nless 180 mm	1150G	

Quantity/Description

1	extra-long needle knurled nose pliers, slip-proof double layer PVC coated handles, industrial finish \bullet 160 mm	Beta N.	1166G
4	screwdriver for slotted head screws \bullet 3x75-4x100-5,5x100-6,5x150 mm		1201E
3	screwdriver for cross head Phillips® screws \oplus PH0x60-PH1x80-PH2x100 mm		1202E
1	engineer's hammer 300 g		1370
1	measuring tape 3 m		1692/3
1	snap - off blade utility knife 18 mm		1771
1	car service knife		1778SOS
1	high-brightness LED torch, made of sturdy anodized aluminium, up to 500 lumens		1833S

5915VU/0

059151021

Assortment recommended in combination with C4 - C5 - C6T

Universal use



5 kg

Quantity/Description

2	drift punches Ø 2-3 mm
1	centre punch Ø 4 mm
2	flat chisels 125-150 mm
1	cape chisels, standard type 150 mm
14	combination wrenches 6-14 - 17 - 19 - 21 - 22 - 24 mm
9	offset hexagon key wrenches 1,5 - 2 - 2,5 - 3 - 4 - 5 - 6 - 8 - 10 mm
1	adjustable wrench 250 mm
1	Slip joint pliers boxed joints 250 mm
1	diagonal cutting nippers, slip-proof double layer PVC coated handles, industrial finish 160 mm

Beta N.

30
32
34
36
42NEW
96/SC9
111
1048
1082G

Quantity/Description

1	electrician's scissors, straight blades	1128BMX
1	heavy duty combination pliers, slip-proof double layer PVC coated handles, industrial finish 180 mm	1150G
1	extra-long needle knurled nose pliers, slip-proof double layer PVC coated handles, industrial finish 160 mm	1166G
4	screwdriver for slotted head screws 3x75 - 4x100 - 5,5x100 - 6,5x150 mm	1201E
3	screwdriver for cross head Phillips® screws PH0x60 - PH1x80 - PH2x100 mm	1202E
1	engineer's hammer 300 g	1370
1	measuring tape 5 m	1692
1	snap - off blade utility knife	1771

5915VU/1

059151024

Assortment recommended in combination with C9 - C10 - C10S - C11 - CP15 - CP15L - C16 - CP17 - CP17L - C18

Universal use



Quantity/Description

8	double open end wrenches 6x7 - 8x9 - 10x11 - 12x13 - 14x15 - 16x17 - 18x19 - 20x22 mm
9	offset hexagon key wrenches \odot 1,5 - 2 - 2,5 - 3 - 4 - 5 - 6 - 8 - 10 mm
13	1/4" hexagon sockets \odot 4 - 4,5 - 5 - 5,5 - 6 - 7 - 8 - 9 - 10 - 11 - 12 - 13 - 14 mm
1	1/4" drive extension bar 150 mm
1	1/4" drive universal joint
1	1/4" drive spinner handle
1	1/4" drive swivel T-handle

Beta N.
55/B896/SC9
900

900/21

900/25

900BG/30

900/42

Quantity/Description

1	1/4" reversible ratchet \oplus
1	Slip joint pliers boxed joints 250 mm
1	electrician's scissors, straight blades
1	heavy duty combination pliers, slip-proof double layer PVC coated handles, industrial finish \equiv 180 mm
4	screwdriver for slotted head screws
	\bullet 3x75 - 4x100 - 5,5x150 - 6,5x150 mm
3	screwdriver for cross head Phillips® screws
	\oplus PH0x60 - PH1x80 - PH2x100 mm
1	engineer's hammer 300 g
1	measuring tape 3 m
1	plastic oil bottle 30 cc
1	snap - off blade utility knife 18 mm

Beta N.

900/55

1048

1128BMX

1150G

1201E

1202E

1370

1692

1755

1771

Universal use

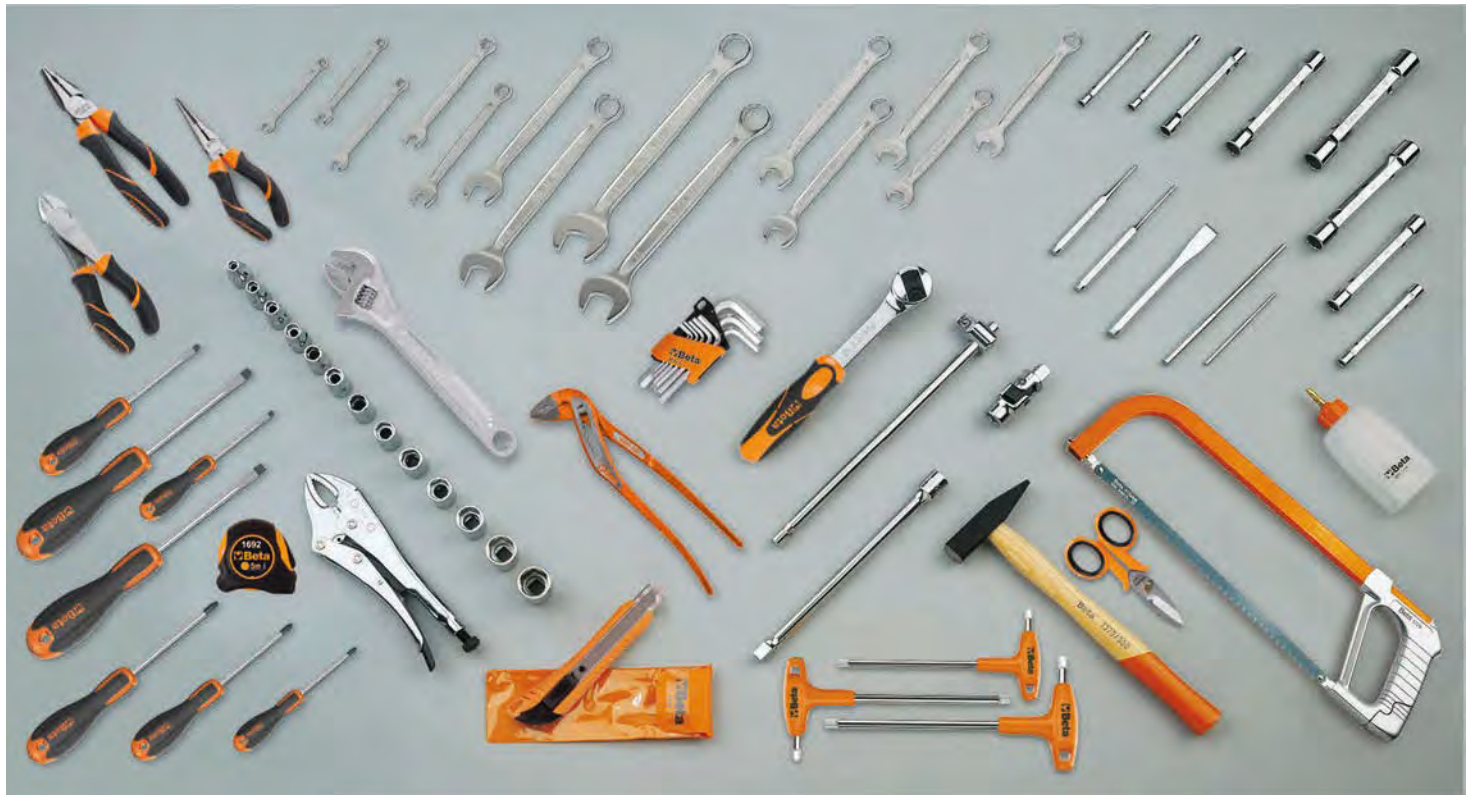

8.1 kg

Quantity/Description

- 1 pin punches Ø 4 mm
- 1 centre punch Ø 4 mm
- 1 flat chisels 150 mm
- 14 combination wrenches 6-7-8-10-11-12-13-14-15-16-17-19-22-24 mm
- 9 offset hexagon key wrenches \odot 1,5+10 mm
- 3 offset hexagon key wrenches \odot 4 - 5 - 6 mm
- 1 adjustable wrench 250 mm
- 13 1/2" square drive hexagon sockets \odot 8+17 - 19 - 22 - 24 mm
- 1 1/2" drive extension bar 255 mm
- 1 1/2" drive universal joint
- 1 1/2" drive sliding T-handle
- 1 1/2" drive reversible ratchet \oplus
- 8 double ended hexagon tubular socket wrenches, light series 6x7 - 8x9 - 10x11 - 12x13 - 14x15 - 16x17 - 18x19 - 20x22 mm
- 2 tommy bars for tubular wrenches

Beta N.

- 31
- 32
- 34
- 42NEW
- 96/SC9
- 96T
- 111
- 920A
- 920/22
- 920/25
- 920/42
- 920/55
- 935
- 940

Quantity/Description

- 1 slip joint pliers 250 mm
- 1 self - locking pliers 240 mm
- 1 heavy duty diagonal cutting nippers, slip-proof double layer PVC coated handles, industrial finish ∇ 160 mm
- 1 electrician's scissors, straight blades
- 1 heavy duty combination pliers, slip-proof double layer PVC coated handles, industrial finish \equiv 180 mm
- 1 extra-long needle knurled nose pliers, slip-proof double layer PVC coated handles, industrial finish \bullet 160 mm
- 4 screwdriver for slotted head screws \bullet 3x75 - 4x100 - 5,5x150 - 6,5x150 mm
- 3 screwdriver for cross head Phillips® screws \oplus PH0x60 - PH1x80 - PH2x100 mm
- 1 engineer's hammer 400 g
- 1 measuring tape 5 m
- 1 hacksaw frame, aluminium handle
- 1 plastic oil bottle 150 cc
- 1 snap - off blade utility knife

Beta N.

- 1048V
- 1052
- 1084G
- 1128BMX
- 1150G
- 1166G
- 1201E
- 1202E
- 1370
- 1692
- 1726
- 1755
- 1771

5915VU/3

059151028

Assortment recommended in combination with C7 - C9 - C10 - C10S - C11 - CP15L - C16 - CP17 - CP17L - C19 - C19L - C20 - C20L

Universal use



11.2 kg

Quantity/Description

- 1 pin punches Ø 4 mm
- 1 centre punch Ø 4 mm
- 1 flat chisels 150 mm
- 15 combination wrenches 6-7-8-9-10-11-12-13-14-15-16-17-19-22-24 mm
- 9 offset hexagon key wrenches \odot 1,5+10 mm
- 1 adjustable wrench 250 mm
- 13 1/2" square drive hexagon sockets \odot 8+17 - 19 - 22 - 24 mm
- 1 1/2" drive extension bar 255 mm
- 1 1/2" drive universal joint
- 1 1/2" drive sliding T-handle
- 1 1/2" drive reversible ratchet
- 17 double ended hexagon/bi - hex offset socket wrenches 6+22 mm
- 1 Slip joint pliers boxed joints 250 mm

Beta N.

- 31
- 32
- 34
- 42NEW
- 96/SC9
- 111
- 920A
- 920/22
- 920/25
- 920/42
- 920/55
- 932/S17
- 1048

Quantity/Description

- 1 self - locking pliers 240 mm
- 1 heavy duty diagonal cutting nippers, bi-material handles, industrial finish ∇ 160 mm
- 1 electrician's scissors, straight blades
- 1 heavy duty combination pliers, bi-material handles, industrial finish \equiv 180 mm
- 1 extra-long needle knurled nose pliers, bi-material handles, industrial finish \bullet 160 mm
- 4 screwdriver for slotted head screws \bullet 3x75 - 4x100 - 5,5x150 - 6,5x150 mm
- 3 screwdriver for cross head Phillips® screws \oplus PH0x60 - PH1x80 - PH2x100 mm
- 1 riveting hammer 32 mm
- 1 measuring tape 5 m
- 1 hacksaw frame, aluminium handle
- 1 plastic oil bottle 150 cc
- 1 snap - off blade utility knife

Beta N.

- 1052
- 1084GBM
- 1128BMX
- 1150GBM
- 1166GBM
- 1201E
- 1202E
- 1370F
- 1692
- 1726
- 1755
- 1771

5915VU/4

059151045

Assortment recommended in combination with C20 - C20L

Universal use



Quantity/Description

1	pin punches Ø 4 mm
1	centre punch Ø 4 mm
1	flat chisels 150 mm
17	combination wrenches 6-7-8-9-10-11-12-13-14-15-16-17-18-19-20-21-22 mm
8	double open end wrenches 6x7-8x9-10x11-12x13-14x15-16x17-18x19-20x22 mm
9	ball head offset hexagon key wrenches ○
1	adjustable wrench 250 mm
39	11 hexagon sockets, 20 bits and 8 accessories
13	11 sockets and 2 accessories
1	Slip joint pliers boxed joints 250 mm
1	self - locking pliers 240 mm
1	diagonal cutting nippers, slip-proof double layer PVC coated handles, industrial finish ◊ 160 mm

Beta N.

31
32
34
42NEW
55/S8
96BPC/SC9
111
900/C11
920A/C11
1048
1052
1082G

Quantity/Description

1	construction worker's pincers 220 mm	1098
1	electrician's scissors, straight blades	1128BMX
1	heavy duty combination pliers, slip-proof double layer PVC coated handles, industrial finish ≡ 180 mm	1150G
1	extra-long needle knurled nose pliers, slip-proof double layer PVC coated handles, industrial finish ● 160 mm	1166G
3	screwdriver for cross head Phillips® screws ⊕ PH0x60 - PH1x80 - PH2x100 mm	1202E
1	engineer's hammer 300 g	1370
1	soft face hammer Ø 35 mm	1390
1	measuring tape 3 m	1692/3
1	second cut files	1719BMA8/M
1	hacksaw frame, aluminium handle 440 mm	1726
1	snap - off blade utility knife 18 mm	1771BM
1	LED inspection torch, made of sturdy anodized aluminium	1833XS/2
4	screwdriver for slotted head screws ● 3x75 - 4x100 - 5,5x100 - 6,5x100 mm	1201E

Beta N.

1098
1128BMX
1150G
1166G
1202E
1370
1390
1692/3
1719BMA8/M
1726
1771BM
1833XS/2

5915VU/5

059151046

Assortment recommended in combination with C12 - C41S - C41H - C42S - C42H

Universal use



9.3 kg

Quantity/Description

- 1 pin punches Ø 4 mm
- 1 centre punch Ø 4 mm
- 1 flat chisels 150 mm
- 13 combination wrenches 1/4 - 5/16 - 3/8 - 7/16 - 1/2 - 9/16 - 5/8 - 11/16 - 3/4 - 13/16 - 7/8 - 15/16 - 1"
- 8 double ended offset ring wrenches 1/4"+1"
- 9 offset hexagon key wrenches, burnished ○ 3/64"+3/8"
- 1 adjustable wrench 250 mm
- 11 1/2" square drive bi - hex sockets ○ 3/8 - 7/16 - 1/2 - 9/16 - 5/8 - 11/16 - 3/4 - 13/16 - 7/8 - 15/16 - 1"
- 1 1/2" drive extension bar 125 mm
- 1 1/2" drive extension bar 255 mm
- 1 1/2" drive universal joint
- 1 1/2" drive sliding T-handle
- 1 1/2" drive reversible ratchet

Beta N.

- 31
- 32
- 34
- 42AS
- 90AS/8
- 96AS/SC9
- 111
- 920AS
- 920/21
- 920/22
- 920/25
- 920/42
- 920/55

Quantity/Description

- 1 Slip joint pliers boxed joints 250 mm
- 1 self - locking pliers 240 mm
- 1 heavy duty diagonal cutting nippers, bi-material handles, industrial finish 160 mm
- 1 electrician's scissors, straight blades
- 1 heavy duty combination pliers, bi-material handles, industrial finish 180 mm
- 1 extra-long needle knurled nose pliers, bi-material handles, industrial finish 160 mm
- 4 screwdriver for slotted head screws 3x75 - 4x100 - 5,5x150 - 6,5x150 mm
- 3 screwdriver for cross head Phillips® screws PH0x60 - PH1x80 - PH2x100 mm
- 1 engineer's hammer 300 g
- 1 measuring tape 5 m
- 1 hacksaw frame, aluminium handle
- 1 plastic oil bottle 150 cc
- 1 snap - off blade utility knife

Beta N.

- 1048
- 1052
- 1084GBM
- 1128BMX
- 1150GBM
- 1166GBM
- 1201E
- 1202E
- 1370
- 1692
- 1726
- 1755
- 1771

5915VU/AS

059151032

Assortment recommended in combination with C10 - C20 - C20L

Universal use



MC10



MC20

Quantity/Description

Quantity/Description	Beta N.	TR
16 combination wrenches 6-7-8-9-10-11-12-13-14-15-16-17-18-19-21-22 mm	42NEW	MC10
9 offset hexagon key wrenches \odot 1,5-2-2,5-3-4-5-6-8-10 mm	96/SC9	MC10
1 Heavy-duty diagonal cutting nippers \llcorner 160 mm	1084BM	MC10
1 heavy duty combination pliers, slip-proof double layer PVC coated handles, industrial finish \equiv 180 mm	1150G	MC10
1 extra-long needle knurled nose pliers, slip-proof double layer PVC coated handles, industrial finish \bullet 160 mm	1166G	MC10
3 screwdriver for slotted head screws \bullet 3,5x100-5,5x150-6,5x150 mm	1201E	MC10
3 screwdriver for cross head Phillips® screws \oplus PH0x3x60-PH1x4,5x80-PH2x6x100 mm	1202E	MC10
31 bits with magnetic quick release bit holder in plastic case \bullet \odot \oplus \otimes \otimes	860MIX/A31	MC20
1 Slip joint pliers boxed joints 250 mm	1048	MC20
1 engineer's hammer 300 mm	1370	MC20
1 centre punch 4 mm	32	MC20

Quantity/Description

Quantity/Description	Beta N.	TR
1 cape chisels, standard type 4 mm	36	MC20
13 1/4" hexagon sockets \odot 4-4,5-5-5,5-6-7-8-9-10-11-12-13-14 mm	900	MC20
1 1/4" drive extension bar 150 mm	900/21	MC20
1 1/4" drive universal joint	900/25	MC20
1 1/4" drive spinner handle	900BG/30C	MC20
1 1/4" drive swivel T-handle	900/42	MC20
1 1/4" reversible ratchet \otimes	900/55	MC20
16 1/2" square drive hexagon sockets \odot 10-11-12-13-14-15-16-17-18-19-21-22-24-27-30-32 mm	920A	MC20
1 1/2" drive universal joint	920/25	MC20
1 1/2" wobble extension bar 125 mm	920AN/125	MC20
1 1/4" drive swivel T-handle	900/42	MC20
1 1/4" reversible ratchet \otimes	900/55	MC20
1 socket holder	895/1	MC20

Universal use

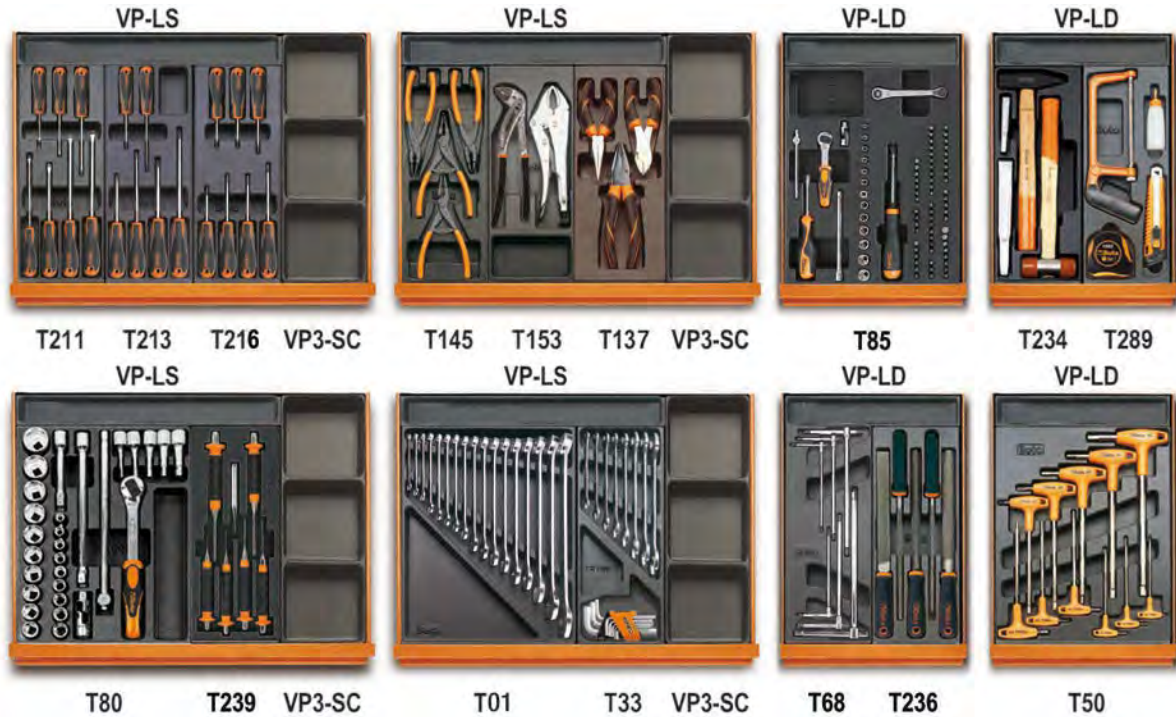

Quantity/Description

Beta N. TR

Quantity/Description

Beta N. TR

7	screwdriver for slotted head screws ● 2,5x50 - 3x75 - 3,5x100 - 4x125-5,5x100 - 5,5x150 - 6,5x150 mm	1201E	T211
6	screwdriver for cross head Phillips® screws ⊕ PH0x60-PH1x80-PH1x120-PH2x100-PH2x150-PH3x150 mm	1202E	T213
7	screwdrivers for Torx® head screws, with handles ⊙ T6-T7-T8-T9-T10-T15-T20	1207E/TX	T216
1	circlip pliers straight, internal ○ 180 mm	1032	T145
1	circlip pliers bent, internal ○ 170 mm	1034	T145
1	circlip pliers straight, external ● 175 mm	1036	T145
1	circlip pliers bent, external ● 175 mm	1038	T145
1	Slip joint pliers boxed joints 240 mm	1048	T153
1	self - locking pliers 240 mm	1052	T153
1	Heavy-duty diagonal cutting nippers ✂ 160 mm	1084BM	T137
1	half-round needle nose pliers = 180 mm	1150BM	T137
1	Extra-long needle nose pliers ● 160 mm	1166BM	T137
1	reversible ratcheting wrench for bits 1/4x5/16	194	T85
13	1/4" hexagon sockets ○ 4-4,5-5-5,5-6-7-8-9-10-11-12-13-14 mm	900	T85
1	1/4" reversible ratchet ⊕ 125 mm	900/55	T85
1	1/4" drive swivel T-handle 115 mm	900/42	T85
1	1/4" drive spinner handle 176 mm	900BG/30	T85
1	1/4" drive universal joint 41 mm	900/25	T85
1	1/4" drive extension bar 150 mm	900/21	T85
1	magnetic bit holder with handle 230 mm	851SR	T85
5	bits for Spanner screws ● 4-6-8-10-12 mm	861SP	T85
8	bits for Torq-Set® head screws ⊕ 0-1-2-3-4-5-6-8 mm	861TQS	T85
6	bits for Tri-Wing® head screws ● 1-2-3-4-5-6 mm	861TRW	T85
8	bits for Tamper Resistant Torx® head screws ⊕ T9-T10-T15-T20-T25-T27-T30-T40	861RTX	T85
11	bits for Torx® head screws ⊙ T6-T7-T8-T9-T10-T15-T20-T25-T27-T30-T40	861TX	T85
3	bits for cross head Pozidriv®-Supadriv® screws ⊕ PZ1 - PZ2 - PZ3	861PZ	T85

4	bits for cross head Phillips® screws ⊕ PH0 - PH1 - PH2 - PH3	861PH	T85
8	hexagon bits for power drivers ○ 2 - 2,5 - 3 - 4 - 5 - 6 - 8 - 10 mm	861PE	T85
7	bits for slotted head screws ● 0,5x3 - 0,6x4,5 - 0,8x5,5 - 1x5,5 - 1,2x6,5 - 1,2x8 - 1,6x8 mm	861LP	T85
2	flat chisels, ribbed type 100 - 200 mm	35	T234
1	engineer's hammer 300 g	1370	T234
1	soft face hammer Ø 35 mm	1390	T234
1	measuring tape 5 m	1692	T289
1	mini hacksaw frame	1725CR	T289
1	plastic oil bottle	1755	T289
1	snap - off blade utility knife	1771	T289
19	1/2" square drive hexagon sockets ○ 10 - 11 - 12÷19 - 20 - 21 - 22 - 23 - 24 - 26 - 27 - 30 - 32 mm	920A	T80
5	1/2" drive, socket drivers for hexagon screws ○ 5 - 6 - 8 - 10 - 12 mm	920ME	T80
1	1/2" drive extension bar 125 mm	920/21	T80
1	1/2" drive extension bar 255 mm	920/22	T80
1	1/2" drive universal joint	920/25	T80
1	1/2" drive sliding T-handle	920/42	T80
1	1/2" drive reversible ratchet ⊕	920/55	T80
1	centre punch Ø 4 mm	32	T239
6	pin punches with handles 2-3-4-5-6-8 mm	31BM	T239
17	combination wrenches 6-7-8-10-11-12-13-14-16-17-18-19-21-22-24-27-30 mm	42NEW	T01
8	double open end wrenches 6x7 - 8x9 - 10x11 - 12x13 - 14x15 - 16x17 - 18x19 - 20x22 mm	55	T33
9	offset hexagon key wrenches ○	96/SC9	T33
6	T-handle wrenches with hexagon male ends ○ 2,5 - 3 - 4 - 5 - 6 - 8 mm	951	T68
5	second cut files 200 mm	1719BMA8/S5	T236
11	offset hexagon key wrenches ○ 2 - 2,5 - 3 - 3,5 - 4 - 4,5 - 5 - 6 mm	96T	T50
4	thermoformed trays, empty	VP-3SC	VP-3SC
4	thermoformed trays, empty	VP-LS	VP-LS
4	thermoformed trays, empty	VP-LD	VP-LD

Universal use



Quantity/Description

- 6 pin punches 2 ÷ 8 mm
- 6 2 drift punches, 1 centre punch, 3 flat chisels with metal holder
- 17 combination wrenches 6÷22 - 24 - 27 - 30 - 32 mm
- 12 double open end wrenches 6x7 ÷ 30x32 mm
- 8 offset hexagon key wrenches 2 ÷ 10 mm
- 8 offset key wrenches, for Torx® head screws Ⓞ T9 ÷ T40
- 1 adjustable wrench 250 mm
- 13 1/2" square drive hexagon sockets with rail Ⓞ 10 ÷ 22 mm
- 8 1/2" square drive hexagon sockets with rail Ⓞ 23 ÷ 32 mm
- 7 socket drivers for cross head Phillips® screws ●
 - 1,2x65 - 1,2x8 - 1,6x9 - 2x12mm - PH1-PH2-PH3
- 1 circlip pliers straight, internal Ⓞ 180 mm
- 1 circlip pliers bent, internal Ⓞ 170 mm
- 1 circlip pliers straight, external ● 175 mm
- 1 circlip pliers bent, external ● 175 mm
- 1 Slip joint pliers boxed joints 250 mm
- 1 self - locking pliers 240 mm
- 1 tin snips 250 mm
- 1 electrician's scissors, straight blades
- 8 set of screwdrivers 2,5x50 - 3x75 - 4x100 - 5,5x125 - 6,5x150 - PH0 - PH1 - PH2
- 2 engineer's hammer 300 - 600 g
- 1 soft face hammer 35

Beta N.

- 31/SP6
- 38/SP6
- 42NEW/S17X
- 55/S12X
- 96T/S8
- 97TX/SC8
- 111
- 920A/SB13
- 920A/SB8
- 920LH/SB7
- 1032
- 1034
- 1036
- 1038
- 1048
- 1052
- 1112
- 1128BMX
- 1263/D8
- 1370
- 1390

Quantity/Description

- 1 measuring tape 5 m
- 1 flexible magnetic pick-up tool
- 1 two cutting edges scraper 200 mm
- 1 three - cutting edges scraper 200 mm
- 5 second cut files 200 mm
- 1 metal oil can 200 cc
- 1 snap - off blade utility knife
- 1 1/2" drive extension bar 125 mm
- 1 1/2" drive extension bar 250 mm
- 1 1/2" drive universal joint
- 1 1/2" drive sliding T-handle
- 1 1/2" drive reversible ratchet Ⓞ
- 1 pry bar
- 1 Diagonal cutting nippers ⚡ 160 mm
- 1 Heavy-duty diagonal cutting nippers ⚡ 160 mm
- 1 toggle lever assisted end cutting nippers ⚡ 180 mm
- 1 half-round needle nose pliers = 180 mm
- 1 Extra-long needle nose pliers ● 160 mm
- 1 Extra-long bent needle nose pliers ● 160 mm
- 2 screwdrivers for cross head Phillips® screws ● 8x200 - 10x200 mm
- 1 screwdrivers for cross head Phillips® screws ● PH3 8x150mm
- 1 sliding gauge
- 1 hacksaw frame, aluminium handle 420 mm

Beta N.

- 1692/5
- 1712E/2
- 1717A
- 1717B
- 1719BMA8/S5
- 1751
- 1771BM
- 920/21
- 920/22
- 920/25
- 920/42
- 920/55
- 963
- 1082BM
- 1084BM
- 1092V
- 1150BM
- 1166BM
- 1168BM
- 1260
- 1262
- 1650
- 1725

Universal use



11.3 kg

Quantity/Description

17	combination wrenches 6+22 mm
12	offset hexagon key wrenches \odot 2+10 mm
13	1/2" square drive hexagon sockets with rail \odot 10+22 mm
8	1/2" square drive hexagon sockets with rail \odot 23+32 mm
1	1/2" drive extension bar 125 mm
1	1/2" drive extension bar 255 mm
1	1/2" drive universal joint
1	1/2" drive sliding T-handle
1	1/2" drive reversible ratchet \oplus
1	circlip pliers straight, internal \odot 180 mm
1	circlip pliers straight, external \bullet 175 mm
1	Slip joint pliers boxed joints 250 mm
1	self-locking pliers 240 mm
1	Heavy-duty diagonal cutting nippers ∇ 160 mm
1	electrician's scissors, straight blades
1	half-round needle nose pliers \equiv 180 mm

Beta N.

42NEW
96N/SC12
920A/SB13
920A/SB8
920/21
920/22
920/25
920/42
920/55
1032
1036
1048
1052
1084BM
1128BMX
1150BM

Quantity/Description

1	Extra-long needle nose pliers \bullet 160 mm
7	screwdrivers for cross head Phillips® screws \bullet 3x75 - 3,5x100 - 4x125
4	screwdrivers for cross head Phillips® screws \oplus PH0x60 - PH1x80
5,5x150 - 6,5x150 - 8x200 - 10x200 mm	
PH2x100 - PH3x150 mm	
1	engineer's hammer 300 g
1	soft face hammer \varnothing 35 mm
1	measuring tape 5 m
5	Set of 5 second-cut files, with handles 200 mm
1	hacksaw frame, aluminium handle
1	plastic oil can 150 cc
1	snap-off blade utility knife

Beta N.

1166BM
1260
1262/S4
1370
1390
1692
1719BMA...S5
1725
1754
1771

Bicycle repairs



Quantity/Description

Beta N.

5 combination wrenches 8-9-10-13-14 mm	42NEW
9 ball head offset hexagon key wrenches burnished \odot 1,5-2-2,5-3-4-5-6-8-10 mm	96BP/SC9
8 offset hexagon key wrenches 2-2,5-3-4-5-6-8-10 mm	96T/S8
8 drivers for Torx® head screws, with handles \odot T8-T10-T15-T20-T25-T27-T30-T40	97TTX/S8
1 adjustable wrenches with scales chrome-plated 200 mm	111G
1 pipe cutter for copper and light alloy pipes	334
1 click-type torque wrenches with reversible ratchets 2+10 Nm	605E
13 \odot 4-4,5-5-5,5-6-7-8-9-10-11-12-13-14 mm	900/SB13
1 1/4" drive extension bar	900/21
1 1/4" drive universal joint	900/25
1 1/4" reversible ratchet \odot	900/55
1 Diagonal cutting nippers ∇ 160 mm	1082
1 electrician's scissors, straight blades 145 mm	1128BM
1 heavy duty combination pliers, slip-proof double layer PVC coated handles, industrial finish \equiv 180 mm	1150G
1 extra-long needle knurled nose pliers, slip-proof double layer PVC coated handles, industrial finish \bullet 180 mm	1166G
7 3x75-4x125-5,5x150-6,5x150-PH0x60-PH1x80-PH2x100 mm	1203E/D

Quantity/Description

Beta N.

1 engineer's hammer 300 g	1370
1 soft face hammer \varnothing 35 mm	1390
1 sliding gauge 150 mm	1650
1 measuring tape 3 m	1692/3
1 second-cut flat files 200 mm	1719BMA...P
1 second-cut half-round files 200 mm	1719BMA...M
1 second-cut round files 200 mm	1719BMA...R
1 hacksaw frame, aluminium handle 300 mm	1725
1 snap - off blade utility knife	1771
1 chain wear indicator 120 mm	3935
1 missing link pliers 170 mm	3937
7 set of 7 simple cone wrenches 13-14-15-16-17-18-19 mm	3952/S7
1 pedal wrench 15 mm	3953
1 spoke wrench, black, 3,2 mm \square	3961 3,2
1 spoke wrench, green, 3,3 mm \square	3961 3,3
1 spoke wrench, red, 3,5 mm \square 3	3961 3,5
1 professional spoke wrench, 3,2 - 4,0 mm \square 3,2 - 4,0 mm	3961U
1 sprocket removal wrench with chain whip 289 mm	3967
1 tyre lever 200 mm	3969
3 kit with 3 tyre levers, made of plastic 113 mm	3969K3
1 lever for pushing back disc brake pads 222 mm	3991
1 disc brake straightener 234 mm	3992

5980U/BIKE

059801040

Assortment recommended in combination with C16 - CP17 - CP17L - C20L

Car repairs



M125



M25



M105



M166



M231



M62



M77

Quantity/Description

Beta N. TR

Quantity/Description

Beta N. TR

13	hexagon hand sockets	8-9-10-11-12-13-14-15-16-17-19-21-22 mm	910AL	M125
16	hexagon hand sockets	10-12-13-14-15-16-17-18-19-21-22-23-24-27-30-32 mm	920AL	M125
7	1/2" sockets for Torx® head screws	E12-E14-E16-E18-E20-E22-E24	920FTX	M125
10	socket drivers for hexagon screws	5-6-6L-7-8-8L-10-10L-12-12L mm	920PE	M125
13	1/2" drive, socket drivers for Torx® head screws	T20-T25-T27-T30-T30L-T40-T40L-T45-T50-T50L-T55-T60-T60L	920TX	M125
8	socket drivers with XZN® profile	5-6-6-6L-8-8L-10-10L-12L mm	920XZN	M125
18	combination wrenches	6-7-8-9-10-11-12-13-14-15-16-17-18-19-21-22-24-27 mm	42NEW	M25
7	double ended offset ring wrenches	6x7-8x9-10x11-12x13-14x15-16x17-18x19 mm	90	M25
1	quick release adaptor, 1/4", for 10 mm ratcheting wrenches		123Q1/4	M25
1	quick release adaptor, 3/8", for 13 mm ratcheting wrenches		123Q3/8	M25
1	quick release adaptor, 1/2", for 19 mm ratcheting wrenches		123Q1/2	M25
12	reversible ratcheting combination wrenches	8-9-10-11-12-13-14-15-16-17-18-19 mm	910A	M105
9	ball head offset hexagon key wrenches	1,5-2-2,5-3-4-5-6-8-10 mm	96BPC/SC9	M105
1	socket holder	1/4-1/4	895/1	M105
1	socket holder	1/4-3/8	895/3	M105
1	socket holder	5/16-1/2	895/6	M105
13	1/4" hexagon sockets	4-4,5-5-5,5-6-7-8-9-10-11-12-13-14 mm	900	M105
9	hexagon hand sockets, long series	5-6-7-8-9-10-11-12-13 mm	900L	M105
4	socket drivers for slotted head screws	0,8x4-1x5,5-1,2x6,51,2x8 mm	900LP	M105
5	1/4" socket drivers for hexagon screws	3-4-5-6-7 mm	900ME	M105
4	socket drivers for cross head Phillips® screws	PH1-PH2-PH3-PH4	900PH	M105
7	socket drivers for Torx® head screws	T10-T15-T20-T25-T27-T30-T40	900TX	M105
1	adaptor, 1/4" female and 3/8" male drives	1/4-3/8	900/16	M105
3	1/4" drive extension bar	50-100-150 mm	900/...	M105
1	1/4" drive universal joint		900/25	M105
1	1/4" drive swivel T-handle		900/42	M105
1	1/4" reversible ratchet		900/55	M105
1	1/4" drive spinner handle		900BG/30	M105
17	hexagon hand sockets 3/8"	6-7-8-9-10-11-12-13-14-15-16-17-18-19-20-21-22 mm	910A	M105
1	adaptor, 3/8" female and 1/4" male drives	3/8-1/4	910/15	M105
1	adaptor, 1/2" female and 3/8" male drives	3/8-1/2	910/16	M105
1	extension bar - 3/8"	125 mm	910/21	M105
1	extension bar - 3/8"	250 mm	910/22	M105
1	3/8" drive universal joint		910/25	M105
1	3/8" drive sliding T - handle		910/42	M105
1	3/8" drive reversible ratchet		910/55	M105
21	1/2" square drive hexagon sockets	8-10-11-12-13-4-15-16-17-18-19-20-21-22-23-24-26-27-28-30-32 mm	920A	M105
2	1/2" wobble extension bar	125-250 mm	920AN	M105
1	adaptor, 1/2" female and 3/8" male drives	1/2-3/8	920/15	M105
1	1/2" drive universal joint		920/25	M105
1	1/2" drive sliding T-handle		920/42	M105
1	1/2" drive reversible ratchet		920/55	M105
3	3/8" square drive spark plug sockets	16-17,8-20,8 mm	956E	M105
31	bits with magnetic quick release bit holder in plastic case		860MIX/A31	M166

1	Slip joint pliers boxed joints	250 mm	1048	M166
1	Diagonal cutting nippers	160 mm	1082BM	M166
1	half-round needle nose pliers	180 mm	1150BM	M166
1	Extra-long flat knurled nose pliers	160 mm	1162BM	M166
5	screwdrivers for cross head Phillips® screws	3x75-4x100-5,5x100-6,5x150-8x150 mm	1290	M166
1	screwdriver for slotted head screws, extra-short series	6,5x30 mm	1290N	M166
3	screwdrivers for cross head Phillips® screws	PH1-PH2-PH3	1292	M166
1	screwdriver for cross head Phillips® screws, extra-short series	PH2	1292N	M166
4	drivers for Torx® head screws, with handles	T20-T25-T27-T30	1297TX	M166
6	pin punches	2-3-4-5-6-8 mm	31	M231
1	centre punch	4 mm	32	M231
3	flat chisels	125-150-75 mm	34	M231
1	cape chisels, standard type	125 mm	36	M231
2	engineer's hammer	500-1000 g	1370	M231
1	telescopic magnet with flexible head		1712TF	M231
1	soft face hammer	Ø 35 mm	1390	M231
1	measuring tape	5 m	1692	M125
1	circclip pliers straight, internal	180 mm	1032	M62
1	circclip pliers bent, internal	170 mm	1034	M62
1	circclip pliers straight, external	175 mm	1036	M62
1	circclip pliers bent, external	175 mm	1038	M62
1	smooth half - round long needle nose pliers	140 mm	1177BM	M62
1	diagonal cutting nippers	125 mm	1188BM	M62
4	micro-screwdrivers for slotted head screws	2,0-2,5-3,0-3,5 mm	1257LP	M62
2	micro-screwdrivers for cross-head Phillips® screws	0-00	1257PH	M62
9	drivers for Torx® head screws, with handles	T10-T15-T20-T25-T27-T30-T40-T45-T50	97TTX	M62
1	self - locking pliers	240 mm	1052	M77
1	adjustable self locking pliers, long jaws	180 mm	1058	M77
1	plastic hose pliers		1481PL/A	M77
1	plastic hose pliers		1481PL/B	M77
1	plastic hose pliers		1481PL/C	M77
1	sliding gauge		1650	M77
1	metric feeler gauge		1708/20	M77
1	packing scraper		1716P	M77
7	double swivel end socket wrenches	6x7-8x9-10x11-12x13-14x15-16x17-18x19 mm	80	M77
1	1/2" drive swivel handle		920/36A	M77
1	pry bar with handle	450 mm	965	M77
1	telescopic joint inspection mirror	670 mm	1715	M231
1	second cut files	200 mm	1719BMA8/M	M231
1	second cut files	200 mm	1719BMA8/P	M231
1	second cut files	200 mm	1719BMA8/Q	M231
1	second cut files	200 mm	1719BMA8/R	M231
1	second cut files	200 mm	1719BMA8/T	M231
1	Steel wire brush		1737NX	M231

Universal use



M01



M30

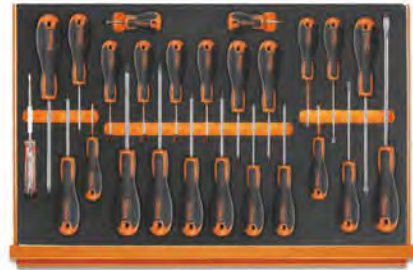

M213



M230



M129

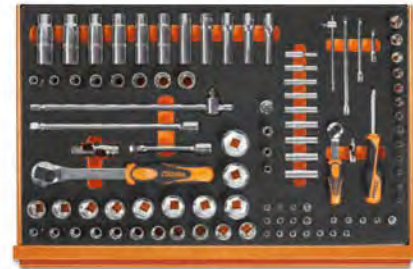

M100

Quantity/Description

22	combination wrenches 6-7-8-9-10-11-12-13-14-15-16-17-18-19-20-21-22-24-27-30-32-36 mm	42NEW	M01
11	double open end wrenches 6x7-8x9-10x11-12x13-14x15-16x17-18x19-20x22-21x23-24x27-30x32 mm	55	M30
11	double ended offset ring wrenches 6x7-8x9-10x11-12x13-14x15-16x17-18x19-20x22-21x23-24x27-30x32 mm	90	M30
9	ball head offset hexagon key wrenches \odot 1,5-2-2,5-3-4-5-6-8-10 mm	96BPC/SC9	M30
6	screwdriver for slotted head screws \bullet 2,5x50-3x75-4x100-5,5x125-6,5x150-8x200 mm	1201E	M213
1	screwdriver for slotted head screws, extra-short series \bullet 4x30 mm	1201EN	M213
4	screwdriver for cross head Phillips® screws \bullet PH0x60-PH1x80-PH2x100-PH3x150 mm	1202E	M213
1	screwdriver for cross head Phillips® screws, extra-short series \bullet PH1x30 mm	1202EN	M213
12	screwdrivers for Torx® head screws, with handles \odot T6-T7-T8-T9-T10-T15-T20-T25-T27-T30-T40-T45	1207E/TX	M213
1	mains testing screwdriver \bullet	1253	M213
3	drift punches \varnothing 2-3-4 mm	30	M230
6	pin punches \varnothing 2-3-4-5-6-8 mm	31	M230
1	centre punch \varnothing 4 mm	32	M230
1	flat chisels 150 mm	34	M230
2	flat chisels, ribbed type 200-250 mm	35	M230
1	cape chisels, standard type 125 mm	36	M230
1	engineer's hammer 500 g	1370	M230
1	soft face hammer \varnothing 35 mm	1390	M230
1	measuring tape 3 m	1692	M230
1	telescopic magnet with flexible head	1712TF	M230
1	second-cut square files 200 mm	1719BMA...Q	M230
1	second-cut triangular files 200 mm	1719BMA...T	M230
1	second-cut flat files 200 mm	1719BMA...P	M230
1	second-cut half-round files 200 mm	1719BMA...M	M230
1	second-cut round files 200 mm	1719BMA...R	M230
1	Steel wire brush	1737NX	M230
1	snap - off blade utility knife 18 mm	1771	M230
1	circlip pliers straight, internal \odot 180 mm	1032	M129
1	circlip pliers bent, internal \odot 170 mm	1034	M129
1	circlip pliers straight, external \bullet 175 mm	1036	M129
1	circlip pliers bent, external \bullet 175 mm	1038	M129
1	Slip joint pliers boxed joints 250 mm	1048	M129
1	self - locking pliers 240 mm	1052	M129

Beta N.

TR

Quantity/Description

1	Diagonal cutting nippers \sphericalangle 160 mm	1082BM	M129
1	construction worker's pincers 220 mm	1098	M129
1	tin snips 250 mm	1112	M129
1	electrician's scissors, straight blades	1128BM	M129
1	half-round needle nose pliers \equiv 180 mm	1150BM	M129
1	Extra-long needle nose pliers \bullet 160 mm	1166BM	M129
1	Extra-long bent needle nose pliers \bullet 160 mm	1168BM	M129
1	socket holder	895/1	M100
1	socket holder	895/3	M100
1	socket holder	895/6	M100
13	1/4" hexagon sockets \odot 4-4,5-5-5,5-6-7-8-9-10-11-12-13-14 mm	900	M100
9	hexagon hand sockets, long series \odot 5-6-7-8-9-10-11-12-13 mm	900L	M100
5	1/4" socket drivers for hexagon screws \odot 3-4-5-6-7 mm	900ME	M100
4	socket drivers for slotted head screws \bullet 0,8x4-1x5,5-1,2x6,5-1,2x8 mm	900LP	M100
4	socket drivers for cross head Phillips® screws \bullet PH1-PH2-PH3-PH4	900PH	M100
7	socket drivers for Torx® head screws \odot T10-T15-T20-T25-T27-T30-T40	900TX	M100
1	1/4" drive extension bar 50 mm	900/20	M100
1	1/4" drive extension bar 100 mm	900/20L	M100
1	1/4" drive extension bar 150 mm	900/21	M100
1	1/4" drive universal joint	900/25	M100
1	1/4" drive spinner handle	900B/G/30	M100
1	1/4" drive swivel T-handle	900/42	M100
1	1/4" reversible ratchet \oplus	900/55	M100
21	1/2" square drive hexagon sockets \odot 8-10-11-12-13-14-15-16-17-18-19-20-21-22-23-24-26-27-28-30-32 mm	920A	M100
1	adaptor, 1/2" female and 3/8" male drives 125 mm	920/15	M100
1	1/2" drive universal joint 250 mm	920/25	M100
1	1/2" wobble extension bar	920AN/125	M100
1	1/2" wobble extension bar	920AN/250	M100
1	1/2" drive sliding T-handle	920/42	M100
1	1/2" drive reversible ratchet \oplus	920/55	M100
8	1/2" sockets for Torx® head screws \odot 10-12-14-16-18-20-22-24 mm	920FTX	M100
11	hexagon hand sockets \odot 10-12-13-14-15-16-17-18-19-21-22 mm	920AL	M100

Beta N.

TR

Electrotechnical maintenance



MB65



MB64

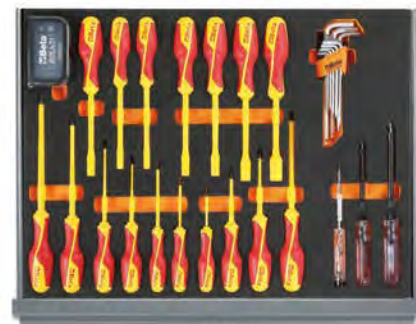

MB63

Quantity/Description

- 1 self - locking pliers 240 mm
- 1 engineer's hammer 500 g
- 1 soft face hammer Ø 35 mm
- 1 second-cut square files 200 mm
- 1 second-cut flat files 200 mm
- 1 second-cut triangular files 200 mm
- 1 second-cut half-round files 200 mm
- 1 second-cut round files 200 mm
- 1 flat chisels, ribbed type 200 mm
- 1 circlip pliers straight, internal Ⓞ 180 mm
- 1 circlip pliers bent, internal Ⓞ 170 mm
- 1 circlip pliers straight, external ● 175 mm
- 1 circlip pliers bent, external ● 175 mm
- 1 Heavy-duty diagonal cutting nippers ⚡ 160 mm
- 1 half-round needle nose pliers = 180 mm
- 1 Extra-long needle nose pliers ● 160 mm
- 9 ball head offset hexagon key wrenches ○
- 1 screwholding screwdriver for slotted head screws ●
- 1 screwholding screwdriver for cross head Phillips® screws ⊕

Beta N.	TR
1052	MB65
1370	MB65
1390	MB65
1719BMA...Q	MB65
1719BMA...P	MB65
1719BMA...T	MB65
1719BMA...M	MB65
1719BMA...R	MB65
35	MB65
1032	MB65
1034	MB65
1036	MB65
1038	MB65
1084BM	MB65
1150BM	MB65
1166BM	MB65
96BPC/SC9	MB63
1250	MB63
1251	MB63

Quantity/Description

- 1 mains testing screwdriver ●
- 6 hexagon nut spinners with handles Ⓞ 5,5-6-7-8-10-13 mm
- 4 screwdrivers for cross head Phillips® screws, 1000V ⊕
PH0x60-PH1x80-PH2x100-PH3x150 mm
- 6 screwdrivers for headless slotted screws, 1000V ● 2,5x75-
3x100-4x100-5,5x125-6x150-8x175 mm
- 31 bits with magnetic quick release bit holder in plastic case ●
○ ⊕ ⊕ ⊕ ⊕
- 1 magnetic bit holder, insulated ®
- 8 double open end wrenches 6x7-8x9-10x11-12x13-14x15
16x17-18x19-20x22 mm
- 1 slip joint pliers, boxed joint 250 mm
- 1 diagonal cutting nippers 1000V ⚡ 140 mm
- 1 electrician's scissors, straight blades, with countersink
- 1 cable cutter 230 mm
- 1 wire stripping pliers ↓ 160 mm
- 1 combination pliers 1000V = 180 mm
- 1 extra long needle nose pliers, 1000V, ● 160 mm
- 1 extra long bent needle nose pliers ● 160 mm
- 1 adjustable wrench, 1000V 250 mm
- 1 utility knife, 1000V
- 1 bent knurled point spring tweezers, 1000V
- 1 crimping pliers for insulated terminals

Beta N.	TR
1253	MB63
943MQ	MB63
1272MQ	MB63
1274MQ	MB63
860MIX/A31	MB63
850MQ	MB63
55	MB64
1048MQ	MB64
1082MQ	MB64
1128BSX	MB64
1132MQ	MB64
1142MQ	MB64
1150MQ	MB64
1166MQ	MB64
1168MQ	MB64
110MQ	MB64
1777MQ	MB64
993MQ	MB64
1602	MB64

Electrotechnical maintenance



7.9 kg

Quantity/Description

- 1 centre punch Ø 4 mm
- 1 flat chisels, ribbed type 150 mm
- 8 double open end wrenches 6x7 - 8x9 - 10x11 - 12x13 - 14x15 - 16x17 - 18x19 - 20x22 mm
- 8 offset hexagon key wrenches, long series ○ 1,5+12 mm
- 1 adjustable wrench 200 mm
- 1 magnetic bit holder, insulated
- 10 bits with magnetic bit holder in plastic case ● ⊕ ⊕
- 1 slip joint pliers, boxed joint 250 mm
- 1 Diagonal cutting nippers 160 mm
- 1 electrician's scissors, straight blades, with countersink
- 1 cable cutter 170 mm
- 1 half-round needle nose pliers = 180 mm
- 1 Extra-long needle nose pliers ● 160 mm
- 1 Extra-long bent needle nose pliers ● 160 mm
- 1 screwholding screwdriver for slotted head screws ● 4x125 mm
- 1 screwholding screwdriver for cross head Phillips® screws ⊕ PH1x150 mm

- Beta N.
- 32
- 35
- 55/B8
- 96LC/SC8
- 111
- 850MQ
- 860MIX/A10
- 1048MQ
- 1082BM
- 1128BSX
- 1132BM
- 1150BM
- 1166BM
- 1168BM
- 1250
- 1251

Quantity/Description

- 1 mains testing screwdriver ●
- 5 screwdriver for slotted head screws ● 2,5x75 - 3,5x100 - 5,5x125 - 6,5x150 mm
- 1 screwdriver for slotted head screws, extra-short series ● 4x30 mm
- 4 screwdriver for cross head Phillips® screws ⊕ PH0x60 - PH1x120 - PH2x150 - PH3x150 mm
- 1 screwdriver for cross head Phillips® screws, extra-short series ⊕ PH2x30 mm
- 4 screwdrivers for cross head Phillips® screws, 1000V ⊕ PH0x60 - PH1x80 - PH2x100 - PH3x150 mm
- 5 screwdrivers for headless slotted screws, 1000V ● 5,5x125 - 3x100 - 4x100 - 6,5x150 - 8x175 mm
- 1 flat chisel with side cutter
- 1 engineer's hammer 300 g
- 1 soft face hammer Ø 35 mm
- 1 crimping pliers for insulated terminals
- 1 25 mm
- 1 measuring tape 5 m
- 1 second-cut half-round files 200 mm
- 1 second-cut round files 200 mm
- 1 hacksaw frame, aluminium handle
- 1 fold - away knife

- Beta N.
- 1253
- 1201E
- 1201EN
- 1202E
- 1202EN
- 1272MQ
- 1274MQ
- 1343
- 1370
- 1390
- 1602
- BMESB1925NE
- 1692
- 1719BMA...M
- 1719BMA...R
- 1725
- 1777BM

5980ET/A

059801083

Assortment recommended in combination with C12 - 2028VV - 2032TV - 2032VV

Electrotechnical maintenance



3.7 kg

Quantity/Description

- 3 pin punches Ø 2 - 3 - 4 mm
- 1 centre punch Ø 4 mm
- 1 flat chisels 150 mm
- 8 double open end wrenches 6x7 - 8x9 - 10x11 - 12x13 - 14x15 - 16x17 - 18x19 - 20x22 mm
- 9 ball head offset hexagon key wrenches \odot 1,5 - 2 - 2,5 - 3 - 4 - 5 - 6 - 8 - 10 mm
- 1 deburrer 150 mm
- 6 hexagon nut spinners with handles 1000V \odot 5,5 - 6 - 7 - 8 - 10 - 13 mm
- 1 slip joint pliers, boxed joint 250 mm
- 1 diagonal cutting nippers 1000V \nless 160 mm
- 1 electrician's scissors, straight blades, with countersink
- 1 cable cutter 230 mm
- 1 wire stripping pliers \updownarrow 160 mm
- 1 combination pliers 1000V \equiv 180 mm
- 1 extra long needle nose pliers, 1000V, \bullet 160 mm
- 1 mains testing screwdriver \bullet
- 3 screwdrivers for cross head Phillips® screws, 1000V \oplus PH0x60 - PH1x80 - PH2x100 mm
- 4 screwdrivers for headless slotted screws, 1000V \bullet 3x100 - 4x100 - 5,5x125 - 6,5x150 mm

Beta N.

- 31
- 32
- 34
- 55/B8
- 96BPC/SC9
- 345SB
- 943MQ/S6
- 1048MQ
- 1082MQ
- 1128BSX
- 1132MQ
- 1142MQ
- 1150MQ
- 1166MQ
- 1253
- 1272MQ
- 1274MQ

Quantity/Description

- 1 engineer's hammer 300 g
- 1 soft face hammer Ø 35 mm
- 1 crimping pliers for insulated terminals
- 1 flexible graduated rule 250 mm
- 1 engineer's scriber 250 mm
- 1 measuring tape 5 m
- 1 spirit level, made of aluminium 200 mm
- 1 electrician's chisel 10x200 mm
- 1 chalk line reel
- 1 square flexible inspection mirror 600 mm
- 1 second cut files 200 mm
- 1 second cut files 200 mm
- 1 spring puller
- 1 hacksaw frame, aluminium handle
- 1 bristle brush
- 1 fitting tool for nylon ties
- 1 plastic oil bottle 80 cc
- 100 nylon cable ties, black UV resistant 3,6x200 mm
- 100 nylon cable ties, black UV resistant 4,8x300 mm
- 1 snap - off blade utility knife
- 1 soldering iron 30 W
- 1 LED inspection torch, made of sturdy anodized aluminium

Beta N.

- 1370
- 1390
- 1602
- 1682
- 1688
- 1692
- 1696
- 1701NE3
- 1705
- 1715FL/A
- 1719BMA8/M
- 1719BMA8/R
- 1723
- 1726BM
- 1738
- 1743
- 1755
- 1748N
- 1748N
- 1771BM
- 1814M
- 1833XS/2

5980ET/B

059801084

Assortment recommended in combination with C12 - 2029/VV - 2033P/VV - 2036TV

5980MQ

assortment of 46 tools

Electrotechnical maintenance



7 kg

Quantity/Description

- 7 single open end wrenches, 1000V 10 - 12 - 13 - 14 - 17 - 19 - 22 mm
- 1 adjustable wrench, 1000V 250 mm
- 6 hexagon nut spinners with handles \varnothing 5,5 - 6 - 7 - 8 - 10 - 13 mm
- 4 T-handle wrenches with hexagon male ends \varnothing 4 - 5 - 6 - 8 mm
- 1 bent knurled point spring tweezers, 1000V
- 1 slip joint pliers, boxed joint 250 mm
- 1 diagonal cutting nippers 1000V \angle 160 mm
- 1 electrician's scissors
- 1 wire stripping pliers \angle 160 mm
- 1 combination pliers 1000V \equiv 180 mm
- 1 extra-long bent flat nose pliers \equiv 160 mm

Beta N.

- 52MQ
- 110MQ
- 943MQ
- 951MQ
- 993MQ
- 1048MQ
- 1082MQ
- 1128MQ
- 1142MQ
- 1150MQ
- 1164MQ

Quantity/Description

- 1 extra long needle nose pliers, 1000V, \bullet 160 mm
- 1 mains testing screwdriver \bullet
- 4 screwdrivers for cross head Phillips® screws, 1000V \oplus PH0x60 - PH1x80 - PH2x100 - PH3x150 mm
- 5 screwdrivers for headless slotted screws, 1000V \bullet 3x100 - 4x100 - 5,5x125 - 6,5x150 - 8x175 mm
- 1 engineer's hammer 300 g
- 1 soft face hammer \varnothing 35 mm
- 1 measuring tape 5 m
- 1 200 mm
- 1 mini - hacksaw frame, 1000V
- 2 utility knife, 1000V
- 1 soldering iron 30 W
- 1 high-brightness LED torch, made of sturdy anodized aluminium, up to 500 lumens
- 1 combination voltage and continuity tester

Beta N.

- 1166MQ
- 1253
- 1272MQ
- 1274MQ
- 1370
- 1390
- 1692
- 1701NE/3
- 1725MQ
- 1777MQ
- 1814M
- 1833S
- 1847P

5980MQ

059801257

Assortment recommended in combination with 2029/VV

5988 VHB-MQ

assortment of 66 tools in EVA foam trays

Electrotechnical maintenance

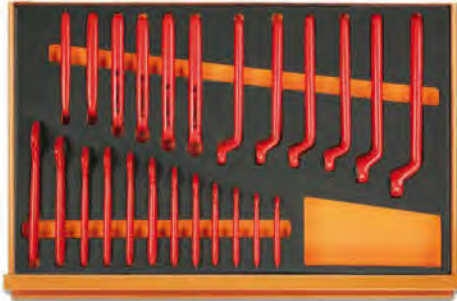

M49



M108



M161

Quantity/Description

- 12 single open end wrenches, 1000V 7-8-10-11-12-13-14-15-16-17-19-22 mm
- 12 single ring wrenches 7-8-10-11-12-13-14-15-16-17-19-22 mm
- 4 socket drivers for hexagon screws \odot 4-5-6-8 mm
- 11 bi-hex sockets \odot 7-8-10-11-12-13-14-15-16-17-19 mm
- 6 socket drivers for Torx® head screws \odot T15-T20-T25-T27-T30-T40
- 2 socket drivers with XZN® profile \odot 8-10 mm
- 1 3/8" drive extension 125 mm
- 1 3/8" drive extension 250 mm
- 1 3/8" drive, T-handle

Beta N.

TR

- 52MQ **M49**
- 89MQ **M49**
- 910MQ/PE **M108**
- 910MQ/B **M108**
- 910MQ/TX **M108**
- 910MQ/XZN **M108**
- 910MQ/21 **M108**
- 910MQ/22 **M108**
- 910MQ/T **M108**

Quantity/Description

- 1 3/8" drive reversible ratchet
- 1 electrician's scissors
- 1 slip joint pliers, boxed joint 250 mm
- 1 diagonal cutting nippers 1000V ∇ 160 mm
- 1 combination pliers 1000V \equiv 180 mm
- 1 extra long flat nose pliers \equiv 160 mm
- 1 extra-long bent flat nose pliers \equiv 160 mm
- 4 screwdrivers for cross head Phillips® screws, 1000V \oplus PH0x60 - PH1x80 - PH2x100 - PH3x150 mm
- 4 screwdrivers for headless slotted screws, 1000V \bullet 2,5x75 - 3x100 - 4x100 - 5,5x125 mm
- 1 cable stripping knife, insulated

Beta N.

TR

- 910MQ/55 **M108**
- 1128MQ **M161**
- 1048MQ **M161**
- 1082MQ **M161**
- 1150MQ **M161**
- 1162MQ **M161**
- 1164MQ **M161**
- 1272MQ **M161**
- 1274MQ **M161**
- 1777MQ/U **M161**

5988 VHB-MQ

059880300

Assortment recommended in combination with items C23ST - C24S - C24SA - C24SA-XL - C24SL - C24SL/CAB
C28 - C37 - C39 - C39SM - C39MD - C39T - RSC55 - C59

Electronics



Quantity/Description

- 13 small double open end wrenches 4÷14 mm
- 9 offset hexagon key wrenches \varnothing 1,5÷10 mm
- 1 bent point tweezers 130 mm
- 1 straight thin knurled point pin spring tweezers 150 mm
- 1 cross tweezers 155 mm
- 1 electrician's scissors, straight blades
- 1 wire stripping pliers ∇ 160 mm
- 1 Extra-long needle nose pliers \bullet 160 mm
- 1 flat nose pliers $=$
- 1 smooth half - round long bent needle nose pliers \bullet
- 1 combination pliers \bullet
- 1 diagonal flush cutting nippers ζ
- 1 diagonal cutting nippers ζ
- 1 screwholding screwdriver for slotted head screws \bullet 4x125 mm

- Beta N. 73/B13
- 96N/SC9
- 991
- 992
- 998
- 1128BMX
- 1142BM
- 1166BM
- 1172BM
- 1178BM/P
- 1178BM
- 1185BM
- 1188BM
- 1250

Quantity/Description

- 1 screwholding screwdriver for cross head Phillips® screws \oplus PH0x125 mm
- 8 micro-screwdrivers
- 1 engineer's hammer 200 g
- 1 measuring tape 5 m
- 1 telescopic joint inspection mirror
- 3 needle files
- 1 spring puller
- 1 bristle brush
- 1 pen oiler
- 1 snap - off blade utility knife
- 1 self-locking round end knurled tool made of stainless steel
- 1 soldering iron 25 W
- 1 de - soldering pump
- 1 LED inspection torch, made of sturdy anodized aluminium

- Beta N. 1251
- 1257LPH/S8
- 1370
- 1692
- 1715
- 1720/S3
- 1723
- 1738
- 1756
- 1771
- 1002
- 1814M
- 1830T
- 1833XS/2

Electronics



Quantity/Description

- 13 small double open end wrenches 4+14 mm
- 9 offset hexagon key wrenches \varnothing 1,5+10 mm
- 8 offset key wrenches for Torx® head screws \odot T9 - T10 - T15 - T20 - T25 - T27 - T30 - T40
- 1 adjustable wrench 150 mm
- 18 set of 13 hexagon sockets and 5 accessories, 1/4" square drive
- 1 straight thin knurled point spring tweezers 130 mm
- 1 bent point tweezers 130 mm
- 1 extra slim short end spring tweezers 120 mm
- 1 electrician's scissors, straight blades
- 1 front wire stripping pliers, self - adjusting 170 mm
- 1 half-round needle nose pliers \equiv 180 mm
- 1 flat nose pliers \equiv 140 mm
- 1 smooth half - round long needle nose pliers \bullet 140 mm
- 1 smooth half - round long bent needle nose pliers \bullet 140 mm
- 1 diagonal flush cutting nippers, rounded tips ζ 120 mm
- 1 diagonal flush cutting nippers, slim tips ζ 120 mm
- 1 end flush oblique cutting nippers ζ
- 8 micro-screwdrivers
- 1 mains testing screwdriver \bullet
- 1 screwdriver for slotted head screws, extra-short series \bullet 6,5x30 mm

Beta N.

- 73/B13
- 96/SC9
- 97TX/BG8
- 111
- 900/C13-5
- 990
- 991
- 999A
- 1128BMX
- 1149F
- 1150BM
- 1172BM
- 1177BM
- 1178BM/P
- 1184BM
- 1186BM
- 1191BM
- 1257LPH/S8
- 1253
- 1290N

Quantity/Description

- 3 screwdrivers for cross head Phillips® screws \oplus PH0x60 - PH1x80 - PH2x100 mm
- 2 screwdriver for cross head Phillips® screws, extra-short series \oplus PH1x30 - PH2x30 mm
- 5 screwdrivers for headless slotted screws \bullet 2,5x60 - 3x75 - 4x100 - 5x125 - 6,5x150 mm
- 1 engineer's hammer 200 g
- 1 flexible graduated rule 150 mm
- 1 engineer's scriber 220 mm
- 1 measuring tape 5 m
- 1 telescopic joint inspection mirror 670 mm
- 1 Needle files \bullet
- 1 Needle files \blacktriangle
- 1 Needle files \blacksquare
- 1 spring puller
- 1 bristle brush
- 1 pen oiler
- 1 snap - off blade utility knife
- 1 fold - away knife
- 1 self-locking round end knurled tool made of stainless steel
- 1 soldering iron 25W
- 1 de - soldering pump
- 1 LED inspection torch, made of sturdy anodized aluminium

Beta N.

- 1292
- 1292N
- 1294
- 1370
- 1682
- 1688
- 1692
- 1715
- 1720R
- 1720T
- 1720P
- 1723
- 1738
- 1756
- 1771BM
- 1777BM
- 1002
- 1814M
- 1830T
- 1833XS/2

5980EL/B

059801082

Assortment recommended in combination with 2029/VV - 2033P/VV - 2036TV

5980ID

Assortment of 35 tools

Plumbing maintenance



11.6 kg

Quantity/Description

- 1 flat chisels 150 mm
- 1 flat chisels, ribbed type 200 mm
- 12 double open end wrenches 6x7 - 8x9 - 10x11 - 12x13 - 14x15 - 16x17 - 18x19 - 20x22 - 21x23 - 24x27 - 25x28 - 30x32 mm
- 1 adjustable wrench 250 mm
- 1 pipe cutter for copper and light alloy pipes Ø 3+30 mm
- 1 pipe wrench Swedish pattern 320 mm
- 1 Slip joint pliers boxed joints 250 mm
- 1 self - locking pliers 240 mm
- 1 tin snips 300 mm
- 1 electrician's scissors, straight blades

Beta N.

- 34
- 35
- 55/S12X
- 111
- 334
- 374
- 1048
- 1052
- 1112
- 1128BMX

Quantity/Description

- 1 heavy duty combination pliers, bi-material handles, industrial finish \equiv 180 mm
- 4 screwdriver for slotted head screws \bullet 3x75 - 4x100 - 5,5x150 - 8x150 mm
- 2 screwdriver for cross head Phillips® screws \oplus PH1x80 - PH2x100 mm
- 1 engineer's hammer 300 g
- 1 measuring tape, made of fibre 2 m
- 1 measuring tape 5 m
- 1 spirit level, made of aluminium 200 mm
- 1 second-cut half-round files 200 mm
- 1 hacksaw frame, aluminium handle
- 1 Steel wire brush

Beta N.

- 1150GBM
- 1201E
- 1202E
- 1370
- 1690F
- 1692
- 1696
- 1719BMA...M
- 1725
- 1737NX

5980ID

059801085

Assortment recommended in combination with 2009N/VV

Car repairs



28.6 kg

Quantity/Description

- 2 drift punches Ø 3 - 4 mm
- 2 pin punches Ø 6 - 8 mm
- 1 centre punch Ø 4 mm
- 2 flat chisels, ribbed type 150 - 200 mm
- 18 combination wrenches 6+14 - 17 - 19 - 22 - 24 - 27 - 30 - 32 - 36 - 41 mm
- 10 double ended offset ring wrenches 6x7 - 8x9 - 10x11 - 12x13 - 14x15 - 16x17 - 18x19 - 20x22 - 24x27 - 30x32 mm
- 10 offset hexagon key wrenches 1,5+12 mm
- 17 1/2" square drive hexagon sockets 10+22 - 24 - 27 - 30 - 32 mm
- 1 1/2" drive extension bar 125 mm
- 1 1/2" drive extension bar 255 mm
- 1 1/2" drive universal joint
- 1 1/2" drive sliding T-handle
- 1 1/2" drive push-through square ratchet
- 11 3/4" square drive hexagon socket 22 - 24 - 27 - 30 - 32 - 36 - 41 - 46 - 50 - 55 - 60 mm
- 1 3/4" drive extension bar 200 mm
- 1 3/4" drive swivel handle
- 1 3/4" drive sliding T - handle
- 1 3/4" drive reversible ratchet
- 1 pry bar

Beta N.

- 30
- 31
- 32
- 35
- 42NEW
- 90
- 96N/B10
- 920A
- 920/21
- 920/22
- 920/25
- 920/42
- 920/50
- 928A
- 928/21
- 928/36A
- 928/42
- 928/55
- 964

Quantity/Description

- 1 Slip joint pliers boxed joints 250 mm
- 1 adjustable self locking pliers, curved jaws
- 1 heavy duty diagonal cutting nippers, bi-material handles, industrial finish 160 mm
- 1 electrician's scissors, straight blades
- 1 heavy duty combination pliers, bi-material handles, industrial finish 180 mm
- 1 extra-long needle knurled nose pliers, bi-material handles, industrial finish 160 mm
- 4 screwdrivers for slotted head screws with hexagon bolsters
- 6,5x150 - 8x175 - 10x200 - 12x250 mm
- 3 screwdrivers for cross head Phillips® screws with hexagon bolsters
- PH2x150 - PH3x175 - PH4x200 mm
- 1 ball pein hammer 900 g
- 1 soft face hammer Ø 35 mm
- 1 metric feeler gauge
- 1 three - cutting edges scraper 200 mm
- 5 Set of 5 second-cut files, with handles 200 mm
- 1 hacksaw frame, aluminium handle

Beta N.

- 1048
- 1055
- 1084GBM
- 1128BMX
- 1150GBM
- 1166GBM
- 1260E
- 1262E
- 1377
- 1390
- 1708/20
- 1717B
- 1719BMA...S5
- 1725

5902MT

059021053

Assortment recommended in combination with C22S - C23S - C23SC - C39T

5902MT/AS

Assortment of 99 tools for earth-moving machinery (CATERPILLAR)

Car repairs



📦 27.3 kg

Quantity/Description

- 2 drift punches Ø 3 - 4 mm
- 2 pin punches Ø 6 - 8 mm
- 1 centre punch Ø 4 mm
- 2 flat chisels, ribbed type 150 - 200 mm
- 20 combination wrenches 1/4+1.1/2"
- 6 double ended offset ring wrenches 1/4x5/16 - 3/8x7/16 - 1/2x9/16 - 5/8x3/4 - 11/16x13/16 - 7/8x15/16"
- 11 offset hexagon key wrenches ○ 3/64+3/8"
- 10 1/2" square drive bi - hex sockets ○ 7/16 - 1/2 - 9/16 - 5/8 - 11/16 - 3/4 - 13/16 - 7/8 - 15/16 - 1"
- 1 1/2" drive extension bar 125 mm
- 1 1/2" drive extension bar 255 mm
- 1 1/2" drive universal joint
- 1 1/2" drive sliding T-handle
- 1 1/2" drive push-through square ratchet ⊕
- 12 hexagon hand sockets 1/4" ○ □ 3/4", 7/8 - 15/16 - 1 - 1.1/16 - 1.1/8 - 1.1/4 - 1.5/16 1.1/2 - 1.5/8 - 1.11/16 - 1.7/8 - 2"
- 1 3/4" drive extension bar 200 mm
- 1 3/4" drive swivel handle
- 1 3/4" drive sliding T - handle
- 1 3/4" drive reversible ratchet ⊕
- 1 pry bar

Beta N.

- 30
- 31
- 32
- 35
- 42AS
- 90AS
- 96AS/B11
- 920AS
- 920/21
- 920/22
- 920/25
- 920/42
- 920/50
- 928AS
- 928/21
- 928/36A
- 928/42
- 928/55
- 964

Quantity/Description

- 1 Slip joint pliers boxed joints 250 mm
- 1 adjustable self locking pliers, curved jaws
- 1 heavy duty diagonal cutting nippers, bi-material handles, industrial finish 160 mm
- 1 electrician's scissors, straight blades
- 1 heavy duty combination pliers, bi-material handles, industrial finish 180 mm
- 1 extra-long needle knurled nose pliers, bi-material handles, industrial finish 160 mm
- 4 screwdrivers for slotted head screws with hexagon bolsters ● 6,5x150 - 8x175 - 10x200 - 12x250 mm
- 3 screwdrivers for cross head Phillips® screws with hexagon bolsters ⊕ PH2x150 - PH3x175 - PH4x200 mm
- 1 ball pein hammer 900 g
- 1 soft face hammer Ø 35 mm
- 1 metric feeler gauge 150 - 200 mm
- 1 three - cutting edges scraper 200 mm
- 5 Set of 5 second-cut files, with handles 200 mm
- 1 hacksaw frame, aluminium handle

Beta N.

- 1048
- 1055
- 1084GBM
- 1128BMX
- 1150GBM
- 1166GBM
- 1260E
- 1262E
- 1377
- 1390
- 1708/20
- 1717B
- 1719BMA...S5
- 1725

5902MT/AS

059021054

Assortment recommended in combination with C22S - C23S - C23SC - C39T

5904VG/2M

assortment of 170 tools in EVA foam trays

Car repairs



M05 M06 VP/M3



M50 M55 M86



M208 M85 M234



M83 M136 M145

Quantity/Description	Beta N.	TR	Quantity/Description	Beta N.	TR
16 combination wrenches 6÷21 mm	42NEW	M05	4 bits for cross head Pozidriv® - Supadriv® screws, coloured ☉	860PZ	M85
5 combination wrenches 22 - 24 - 27 - 30 - 32 mm	42NEW	M06	PZ1 - PZ2 - PZ3 - PZ4		
8 offset hexagon key wrenches Ø 2-2,5-3-4-5-6-7-8 mm	96T	M50	11 bits for Torx® head screws, coloured ☉ T6-T7-T8-T9-T10-T15-T20-T25-T27-T30-T40	860TX	M85
5 drivers for Torx® head screws, with handles ☉ T10-T15-T20-T25-T30	97TTX	M55	8 bits for Tamper Resistant Torx® head screws, coloured ☉ T9-T10-T15-T20-T25-T27-T30-T40	860RTX	M85
7 hexagon bits Ø 4-5-6-7-8-10-12 mm	867PE	M86	1 magnetic bit holder with handle 230 mm	851SR	M85
7 hexagon bits Ø 4-5-6-7-8-10-12 mm	867PE/L	M86	1 reversible bit ratchet 100 mm	860/55	M85
5 bits with XZN® profile Ø 5-6-8-10-12 mm	867XZN	M86	2 flat chisels, ribbed type 100 - 200 mm	35	M234
5 bits with XZN® profile Ø 5-6-8-10-12 mm	867XZN/L	M86	1 engineer's hammer 300 g	1370	M234
7 bits for Torx® head screws ☉ T20-T25-T30-T40-T45-T50-T55	867TX	M86	1 soft face hammer Ø 35 mm	1390	M234
6 bits for Torx® head screws ☉ T25-T30-T40-T45-T50-T55	867TX/L	M86	1 1/2" wobble extension bar 125 mm	920AN/125	M83
7 bits for Tamper Resistant Torx® head screws ☉ T20-T25-T30-T40-T45-T50-T55	867RTX	M86	1 1/2" wobble extension bar 250 mm	920AN/250	M83
1 bit holder sockets for item 867	867/1	M86	1 1/2" drive universal joint	920/25	M83
1 bit holder sockets for item 867	867/2	M86	1 1/2" drive sliding T-handle	920/42	M83
5 screwdrivers for cross head Phillips® screws ● 3x75 - 3,5x100 - 4x125 - 5,5x150 - 6,5x150 mm	1260	M208	1 1/2" drive reversible ratchet ☉	920/55	M83
3 screwdrivers for cross head Phillips® screws ☉ PH0x60 - PH1x80 - PH2x100 mm	1262	M208	19 1/2" square drive hexagon sockets ☉ 10÷24 - 26 - 27 - 30 - 32 mm	920A	M83
1 screwdrivers for slotted head screws, extra-short series ● 4x30 mm	1260N	M208	1 half-round needle nose pliers ▬ 180 mm	1150BM	M136
1 screwdrivers for cross head Phillips® screws, extra - short series ☉ PH1x30 mm	1262N	M208	1 Extra-long needle nose pliers ● 160 mm	1166BM	M136
5 bits for slotted head screws, coloured ● 0,5x3 - 0,6x4,5 - 0,8x5,5 - 1x5,5 - 1,2x6,5 mm	860LP	M85	1 Heavy-duty diagonal cutting nippers ⚡ 160 mm	1084BM	M136
8 hexagon bits for power drivers, coloured ☉ 2 - 2,5 - 3 - 4 - 5 - 6 - 8 - 10 mm	860PE	M85	1 circlip pliers straight, internal ☉ 180 mm	1032	M145
5 bits for cross head Phillips® screws, coloured ☉ PH0 - PH1 - PH2 - PH3 - PH4	860PH	M85	1 circlip pliers bent, internal ☉ 170 mm	1034	M145
			1 circlip pliers straight, external ● 175 mm	1036	M145
			1 circlip pliers bent, external ● 175 mm	1038	M145
			1 magnetic bit holder extension bar 80 mm	882P	
			1 adaptors for drivers ■ 1/4 - □ 1/4	892/0	

5904VG/2M

059041198

Assortment recommended in combination with C24S - C24SA - C24SA-XL - C37 - C39
C24SL - C24SL/CAB - C59 - C55 - C39T - C39SM - C39MD - C23ST - C28

5904VG/2T

assortment of 99 tools in ABS thermoformed trays

Car repairs



T05



T153



T208

T06

T80

T138

T145

T234

T33

T52

T55

Quantity/Description

- 16 combination wrenches 6+21 mm
- 5 combination wrenches 22 - 24 - 27 - 30 - 32 mm
- 19 1/2" square drive hexagon sockets
○ 10+24 - 26 - 27 - 30 - 32 mm
- 5 1/2" drive, socket drivers for hexagon screws
○ 5 - 6 - 8 - 10 - 12 mm
- 1 1/2" drive extension bar 125 mm
- 1 1/2" drive extension bar 255 mm
- 1 1/2" drive universal joint
- 1 1/2" drive sliding T-handle
- 1 1/2" drive reversible ratchet ☸
- 1 Slip joint pliers boxed joints 250 mm
- 1 self - locking pliers 240 mm
- 1 Heavy-duty diagonal cutting nippers 160 mm
- 1 Extra-long needle nose pliers ● 160 mm
- 1 half-round needle nose pliers ≡ 180 mm
- 1 circlip pliers straight, internal ○ 180 mm
- 1 circlip pliers straight, external ● 175 mm

Beta N.	TR
42NEW	T05
42NEW	T06
920A	T80
920ME	T80
920/21	T80
920/22	T80
920/25	T80
920/42	T80
920/55	T80
1048	T153
1052	T153
1084	T138
1166	T138
1150	T138
1032	T145
1036	T145

Quantity/Description

- 1 circlip pliers bent, internal ○ 170 mm
- 1 circlip pliers bent, external ● 175 mm
- 2 flat chisels, ribbed type 100 - 200 mm
- 1 engineer's hammer 300 g
- 1 soft face hammer Ø 35 mm
- 4 screwdrivers for cross head Phillips® screws
● 3x75 - 4x100 - 5,5x150 - 6,5x150 mm
- 3 screwdrivers for cross head Phillips® screws
⊕ PH0x60 - PH1x80 - PH2x100 mm
- 8 double open end wrenches 6x7 - 8x9 - 10x11 - 12x13 - 14x15
- 16x17 - 18x19 - 20x22 mm
- 9 offset hexagon key wrenches ○ 1,5 - 2 - 2,5 - 3 - 4 - 5 - 6 - 8
- 10 mm
- 6 offset hexagon key wrenches ○ 2 - 2,5 - 3 - 4 - 5 - 6 mm
- 6 drivers for Torx® head screws, with handles ○ T10 - T15 - T20
- T25 - T27 - T30

Beta N.	TR
1034	T145
1038	T145
35	T234
1370	T234
1390	T234
1260	T208
1262	T208
55	T33
96/SC9	T33
96T	T52
97TTX	T55

Car repairs



20.7 kg

Quantity/Description

6	pin punches Ø 2÷8 mm
1	centre punch Ø 5 mm
1	flat chisels, ribbed type 200 mm
17	combination wrenches 6÷22 mm
8	double open end wrenches 6x7 - 8x9 - 10x11 - 12x13 - 14x15 - 16x17 - 18x19 - 20x22 mm
9	offset hexagon key wrenches 1,5 - 2 - 2,5 - 3 - 4 - 5 - 6 - 8 - 10 mm
11	offset hexagon key wrenches 2÷10 mm
13	offset key wrenches for Torx® head screws T6÷T50
1	adjustable wrench 300 mm
13	1/2" square drive hexagon sockets with rail 10÷22 mm
1	1/2" drive extension bar 125 mm
1	1/2" drive extension bar 255 mm
1	1/2" drive universal joint
1	1/2" drive sliding T-handle
1	1/2" drive push-through square ratchet 20
6	T - handle wrenches with swivelling socket 8 - 10 - 12 - 13 - 17 - 19 mm
1	pry bar with handle 450 mm
2	circlip pliers straight, internal 180 - 225 mm
2	circlip pliers bent, internal 170 - 210 mm
2	circlip pliers straight, external 175 - 225 mm
2	circlip pliers bent, external 175 - 220 mm
1	Slip joint pliers boxed joints 250 mm
1	self - locking pliers 240 mm
1	heavy duty diagonal cutting nippers, bi-material handles, industrial finish 200 mm
1	toggle lever assisted end cutting nippers 200 mm

Beta N.

31/B6
32
35
42NEW
55
96N/SC9
96T/SP11
97TX/B13
111
920A/SB13
920/21
920/22
920/25
920/42
920/50
952
965
1032
1034
1036
1038
1048
1057A
1084GBM
1092V

Quantity/Description

1	tin snips 250 mm
1	electrician's scissors, straight blades
1	heavy duty combination pliers, bi-material handles, industrial finish 180 mm
4	screwdrivers for cross head Phillips® screws 3x75 - 4x100 - 5,5x125 - 6,5x150 mm
1	screwdrivers for slotted head screws, extra-short series 6,5x30 mm
2	screwdrivers for slotted head screws with hexagon bolsters 8x175 - 10x200 mm
3	screwdrivers for cross head Phillips® screws PH0x100 - PH1x120 - PH2x100 mm
1	screwdrivers for cross head Phillips® screws, extra - short series PH2x30 mm
1	screwdrivers for cross head Phillips® screws with hexagon bolsters PH3x175mm
1	screwdriver for cross head Phillips® screws, long series PH2x400 mm
1	screwdriver for headless slotted screws, long series 6,5x400 mm
1	engineer's hammer 500 g
1	soft face hammer Ø 45 mm
1	adjustable oil filter wrench
1	metric feeler gauge
5	Set of 5 second-cut files, with handles 200 mm
1	hacksaw frame, aluminium handle
1	metal oil can 200 cc

Beta N.

1112
1128BMX
1150GBM
1260
1260N
1260E
1262
1262N
1262E
1262L
1264L
1370
1390
1491
1708/20
1719BMA...S5
1726BM
1751

5904VG/3

059041062

Assortment recommended in combination with C24S - C24SA - C24SA-XL - C37 - C39 with 7 - 8 drawers
C24SL - C24SL/CAB - C59 - C55

5904VG/3T

assortment of 102 tools in ABS thermoformed trays

Car repairs



T199

T202

T83



T145

T153

T137

T234

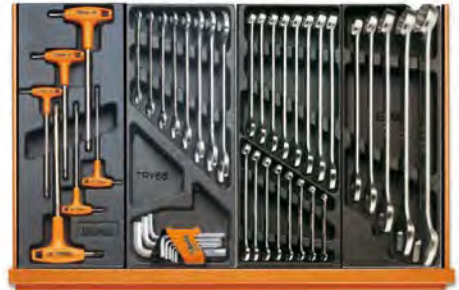

T52

T33

T05

T06



T63

VP5

Quantity/Description

- 21 combination wrenches 6-7-8-9-10-11-12-13-14-15-16-17-18-19-20-21-22-24-27-30-32 mm
- 8 double open end wrenches 6x7-8x9-10x11-12x13-14x15-16x17-18x19-20x22 mm
- 9 offset hexagon key wrenches \odot 1,5+10 mm
- 6 offset hexagon key wrenches \odot 2-2,5-3-4-5-6 mm
- 8 T - handle wrenches with swivelling socket \odot 7-8-10-12-13-14-17-19 mm
- 19 1/2" square drive hexagon sockets \odot 10-11-12-13-14-15-16-17-18-19-20-21-22-23-24-26-27-30-32 mm
- 1 1/2" drive extension bar 125 mm
- 1 1/2" drive extension bar 255 mm
- 1 1/2" drive universal joint
- 1 1/2" drive sliding T-handle 305 mm
- 1 1/2" drive reversible ratchet \odot
- 1 Heavy-duty diagonal cutting nippers \sphericalangle 160 mm
- 1 half-round needle nose pliers \equiv 180 mm
- 1 Extra-long needle nose pliers \bullet 160 mm
- 1 circlip pliers straight, internal \odot 180 mm

Beta N.	TR
42NEW	T05-T06
55	T33
96/SC9	T33
96T	T52
952	T63
920A	T83
920/21	T83
920/22	T83
920/25	T83
920/42	T83
920/55	T83
1084BM	T137
1150BM	T137
1166BM	T137
1032	T145

Quantity/Description

- 1 circlip pliers bent, internal \odot 170 mm
- 1 circlip pliers straight, external \bullet 175 mm
- 1 circlip pliers bent, external \bullet 175 mm
- 1 self - locking pliers 240 mm
- 1 Slip joint pliers boxed joints 250 mm
- 7 screwdrivers for cross head Phillips® screws \bullet 2,5x50 -3x75 -3,5x100-4x125 -5,5x100 - 5,5x150-6,5x150 mm
- 6 screwdrivers for cross head Phillips® screws \oplus PH0x60 - PH0x100 - PH1x80-PH1x120 - PH2x100 - PH2x150 mm
- 2 flat chisels, ribbed type 100-200 mm
- 1 engineer's hammer 300 g
- 1 soft face hammer \varnothing 35 mm
- 1 empty thermoformed tray

Beta N.	TR
1034	T145
1036	T145
1038	T145
1052	T153
1048	T153
1260	T199
1262	T202
35	T234
1370	T234
1390	T234
VP5	

5904VG/3T

059041510

Assortment recommended in combination with C24S - C24SA - C37 - C39
C24SL - C24SL/CAB - C59 - C55 - C23ST - C39T - C28 - C39SM - C39MD

5904VG/5T

assortment of 153 tools in ABS thermoformed trays

Car repairs



T80

T05

T06



T63

VP6



T145

T170

T176

T52



T33

T171

T172

T173



T234

T137

T112

T153

Quantity/Description

- 5 1/2" drive, socket drivers for hexagon screws
 - 5 - 6 - 8 - 10 - 12 mm
- 1 1/2" drive extension bar 125 mm
- 1 1/2" drive extension bar 255 mm
- 1 1/2" drive universal joint
- 1 1/2" drive sliding T-handle
- 1 1/2" drive reversible ratchet
- 19 1/2" square drive hexagon sockets
 - 10÷24 - 26 - 27 - 30 - 32 mm
- 16 combination wrenches 6÷21 mm
- 5 combination wrenches 22 - 24 - 27 - 30 - 32 mm
- 8 T - handle wrenches with swivelling socket ○ 7 - 8 - 10 - 12 - 13 - 14 - 17 - 19 mm
 empty thermoformed tray
- 1 circlip pliers straight, internal ○ 180 mm
- 1 circlip pliers bent, internal ○ 170 mm
- 1 circlip pliers straight, external ● 175 mm
- 1 circlip pliers bent, external ● 175 mm
- 7 screwdrivers for cross head Phillips® screws ● 2,5x50 - 3x75 - 3,5x100 - 4x125 - 5,5x100 - 5,5x150 - 6,5x150 mm
- 5 drivers for Torx® head screws, with handles ○ T25 - T27 - T30 - T40 - T45
- 6 offset hexagon key wrenches ○ 2 - 2,5 - 3 - 4 - 5 - 6 mm
- 8 double open end wrenches 6x7 - 8x9 - 10x11 - 12x13 - 14x15 - 16x17 - 18x19 - 20x22 mm
- 9 offset hexagon key wrenches ○ 1,5 - 2 - 2,5 - 3 - 4 - 5 - 6 - 8 - 10 mm
- 3 screwdrivers for cross head Phillips® screws ● 8x150 - 8x200 - 10x200 mm

Beta N.	TR
920ME	T80
920/21	T80
920/22	T80
920/25	T80
920/42	T80
920/55	T80
920A	T80
42NEW	T05
42NEW	T06
952	T63
	VP6
1032	T145
1034	T145
1036	T145
1038	T145
1290	T170
1297TX	T176
96T	T52
55	T33
96N/SC9	T33
1290	T171

Quantity/Description

- 2 screwdriver for slotted head screws, extra-short series ● 4x30 - 6,5x30 mm
- 6 screwdrivers for cross head Phillips® screws ● PH0x60 - PH0x100 - PH1x80 - PH1x120 - PH2x100 - PH2x150 mm
- 2 screwdrivers for cross head Phillips® screws ● PH3x150 - PH4x200 mm
- 2 screwdriver for cross head Phillips® screws, extra-short series ● PH1x30 - PH2x30 mm
- 2 flat chisels, ribbed type 100 - 200 mm
- 1 engineer's hammer 300 g
- 1 soft face hammer Ø 35 mm
- 1 half-round needle nose pliers = 180 mm
- 1 Extra-long needle nose pliers ● 160 mm
- 1 Heavy-duty diagonal cutting nippers † 160 mm
- 6 bits for Torx® head screws ○ T6÷T15
- 8 bits for Torx® head screws ○ T20÷T55
- 1 socket holder
- 1 socket holder
- 6 1/4" sockets for Torx® head screws ○ E4÷E10
- 7 1/2" sockets for Torx® head screws ○ E12÷E24
- 3 1/2" drive, socket drivers for Torx® head screws ○ T55L - T60 - T70L
- 1 Slip joint pliers boxed joints 250 mm
- 1 self - locking pliers 240 mm
- 1 empty thermoformed tray

Beta N.	TR
1290N	T171
1292	T172
1292	T173
1292N	T173
	35
1370	T234
1390	T234
1150BM	T137
1166BM	T137
1084BM	T137
861TX	T112
866TX	T112
895/1	T112
895/6	T112
900FTX	T112
920FTX	T112
920TX	T112
1048	T153
1052	T153
	VP6

5904VG/5T

059041196

Assortment recommended in combination with C24S with 7 - 8 drawers - C24SA with 7 - 8 drawers - C24SA-XL - C37 with 7 - 8 drawers - C39 with 7 - 8 drawers - C24SL - C24SL/CAB - C59 - C55 - C23ST - C28 - C39MD - C39SM

Car repairs



20 kg

Quantity/Description

1	drift punches Ø 4 mm
6	pin punches Ø 2 - 3 - 4 - 5 - 6 - 8 mm
1	centre punch Ø 4 mm
1	flat chisels 150 mm
1	cape chisels, standard type 150 mm
17	combination wrenches 6÷22 mm
10	offset hexagon key wrenches \odot 1,5+12 mm
1	adjustable wrench 300 mm
12	hi-torque hexagon nut spinners, long series \odot 4+14 mm
1	pry bar with handle 450 mm
1	Slip joint pliers boxed joints 250 mm
1	self - locking pliers 240 mm
1	adjustable self locking pliers, aluminium jaws 280 mm
1	heavy duty diagonal cutting nippers, bi-material handles, industrial finish \approx 160 mm
1	construction worker's pincers 250 mm
1	compound leverage shears, straight blades
1	electrician's scissors, straight blades
1	heavy duty combination pliers, bi-material handles, industrial finish \approx 180 mm
1	screwdriver for Dzus® head screws \bullet
4	screwdrivers for cross head Phillips® screws \bullet 3x75 - 4x100 - 5,5x150 - 6,5x150 mm
1	screwdrivers for slotted head screws, extra-short series \bullet 4x30 mm
2	screwdrivers for slotted head screws with hexagon bolsters \bullet 10x175 - 12x200 mm

Beta N.

30
31/B6
32
34
36
42NEW
96/B10
111N
943BX
965
1048
1052
1060AL
1084GBM
1098PL
1122
1128BMX
1150GBM
1201E/DZ
1260
1260N
1260E

Quantity/Description

3	screwdrivers for cross head Phillips® screws \oplus PH0x60 - PH1x80 - PH2x100 mm
1	screwdrivers for cross head Phillips® screws, extra - short series \oplus PH1x30 mm
1	screwdrivers for cross head Phillips® screws with hexagon bolsters \oplus PH3x175 mm
7	drivers for Torx® head screws \odot T6 - T8 - T10 - T15 - T20 - T25 - T30
1	curved dolly 1350 g
1	toe dolly
1	heel dolly
1	general purpose dolly
1	buffer dolly
1	curved angle spoon
1	heavy duty spoon
1	long double-ended spoon
1	body blade holder, with blade 9"
1	extra flat chisel with hand guard
1	body hammer
1	hammers with round, flat and square faces, wooden shafts Ø 32 mm
1	engineer's hammer 300 g
1	soft face hammer Ø 35 mm
1	measuring tape 5 m

Beta N.

1262
1262N
1262E
1267TX
1303
1305
1306
1310
1313
1326
1327
1330
1338A
1342PM
1345
1357Z/32
1370
1390
1692

5905VG/1

059051058

Assortment recommended in combination with C25

Car repairs



19.5 kg

Quantity/Description

6	2 drift punches, 1 centre punch, 3 flat chisels with metal holder
13	combination wrenches 6+14 - 17 - 19 - 22 - 24 mm
13	double open end wrenches 6x7 - 8x9 - 10x11 - 12x13 - 14x15 - 16x17 - 18x19 - 20x22 - 21x23 - 24x26 - 25x28 - 27x29 - 30x32 mm
3	half - moon ring wrenches 11x13 - 14x17 - 19x22 mm
10	offset hexagon key wrenches \odot 1,5+12 mm
6	drivers for Torx® head screws, with handles \odot T10 - T15 - T20 - T25 - T30 - T40
2	1/2" drive impact sockets \odot 17 - 19 mm
20	1/2" square drive hexagon sockets \odot 10+24 - 26 - 27 - 28 - 30 - 32 mm
1	1/2" drive extension bar 125 mm
1	1/2" drive extension bar 255 mm
1	1/2" drive universal joint
1	1/2" drive sliding T-handle
1	1/2" drive reversible ratchet \odot
8	T - handle wrenches with swivelling socket \odot 7 - 8 - 10 - 11 - 13 - 14 - 17 - 19 mm
1	T - handle swivel spark plug wrenches
1	wheel nut wrench \odot 17x19x22x \blacksquare 1/2"
1	circlip pliers straight, internal \odot 180 mm
1	circlip pliers bent, internal \odot 170 mm
1	circlip pliers straight, external \bullet 175 mm
1	circlip pliers bent, external \bullet 175 mm

Beta N.

38/B6
42NEW
55
83
96N/B10
97TTX
720
920A
920/21
920/22
920/25
920/42
920/55
952
959
979
1032
1034
1036
1038

Quantity/Description

1	Slip joint pliers boxed joints 250 mm	1048
1	self - locking pliers 240 mm	1052
1	heavy duty diagonal cutting nippers, bi-material handles, industrial finish ∇ 160 mm	1084GBM
1	compound leverage shears, straight blades 250 mm	1122
1	electrician's scissors, straight blades	1128BMX
1	heavy duty combination pliers, bi-material handles, industrial finish \equiv 180 mm	1150GBM
1	extra-long needle knurled nose pliers, bi-material handles, industrial finish \bullet 160 mm	1166GBM
8	screwdrivers for cross head Phillips® screws \bullet 2,5x50 - 3x75 - 3,5x100 - 4x125	1260
2	screwdrivers for slotted head screws with hexagon bolsters \bullet 10x200 - 12x250 mm	1260E
1	screwdrivers for slotted head screws, extra-short series \bullet 6,5x30 mm	1260N
4	screwdrivers for cross head Phillips® screws \oplus PH0x60 - PH1x80 - PH2x100 - PH3x150 mm	1262
1	engineer's hammer 400 g	1370
1	soft face hammer \varnothing 35 mm	1390
1	adjustable oil filter wrench	1491
1	circuit tester 3+48 V	1498

5905VG/2

059051044

Assortment recommended in combination with C25

Car repairs



Quantity/Description

- 16 combination wrenches 6+21 mm
- 5 combination wrenches 22 - 24 - 27 - 30 - 32 mm
- 5 pin punches Ø 2 - 3 - 4 - 5 - 6 mm
- 1 centre punch Ø 4 mm
- 12 double open end wrenches 6x7 - 8x9 - 10x11 - 12x13 - 14x15 - 16x17 - 18x19 - 20x22 - 21x23 - 24x26 - 27x29 - 30x32 mm
- 9 offset hexagon key wrenches Ø 1,5 - 2 - 2,5 - 3 - 4 - 5 - 6 - 8 - 10 mm
- 5 1/2" drive, socket drivers for hexagon screws Ø 5 - 6 - 8 - 10 - 12 mm
- 1 1/2" drive extension bar 125 mm
- 1 1/2" drive extension bar 255 mm
- 1 1/2" drive universal joint
- 1 1/2" drive sliding T-handle
- 1 1/2" drive reversible ratchet Ⓞ
- 19 1/2" square drive hexagon sockets Ø 10+24 - 26 - 27 - 30 - 32 mm
- 1 circlip pliers straight, internal Ø 180 mm
- 1 circlip pliers bent, internal Ø 170 mm
- 1 circlip pliers straight, external ● 175 mm
- 1 circlip pliers bent, external ● 175 mm
- 1 circlip pliers straight, internal Ø 140 mm
- 1 circlip pliers straight, internal Ø 225 mm
- 1 circlip pliers straight, external ● 140 mm
- 1 circlip pliers straight, external ● 225 mm
- 9 screwdrivers for cross head Phillips® screws ● 3x75 - 3x100 - 4x100 - 4x150 - 5,5x100 - 5,5x150 - 6,5x150 - 8x150 - 10x200 mm
- 2 screwdrivers for slotted head screws, extra-short series ● 4x30 - 6,5x30 mm
- 7 screwdrivers for cross head Phillips® screws ● PH0x60 - PH0x100 - PH1x80 - PH1x120 - PH2x100 - PH2x150 - PH3x150 mm
- 2 screwdrivers for cross head Phillips® screws, extra - short series ● PH1x30 - PH2x30 mm
- 8 T - handle wrenches with swivelling socket Ø 7 - 8 - 10 - 12 - 13 - 14 - 17 - 19 mm
- 2 screwdriver for cross head Phillips® screws, long series ● PH1x400 - PH2x400 mm
- 3 screwdriver for headless slotted screws, long series ● 3x300 - 4x400 - 5x400 mm
- 6 drivers for Torx® head screws, with handles Ø T10-T15-T20-T25-T27-T30
- 13 1/2" drive impact sockets Ø 10-11-12-13-14-16-17-18-19-21-22-23-24 mm
- 1 1/2" drive impact extension bar 125 mm
- 5 socket drivers for hexagon screws Ø 5L - 6L - 7L - 8L - 10L

Beta N. TR

- 42NEW T05
- 42NEW T06
- 31 T31
- 32 T31
- 55 T31
- 96N/SC9 T31
- 920ME T80
- 920/21 T80
- 920/25 T80
- 920/42 T80
- 920/55 T80
- 920A T80
- 1032 T145
- 1034 T145
- 1036 T145
- 1038 T145
- 1032 T146
- 1032 T146
- 1036 T146
- 1036 T146
- 1260 T167
- 1260N T167
- 1262 T168
- 1262N T168
- 952 T63
- 1262L T209
- 1264L T209
- 97TTX T55
- 720 T110
- 720/21 T110
- 920PE T113

Quantity/Description

- 4 1/2" drive, socket drivers for Torx® head screws Ø T40L - T45L - T55L - T70L
- 3 socket drivers with XZN® profile Ø MGL - M8L - M12L
- 5 second cut files 200 mm
- 1 adjustable oil filter wrench 110 mm
- 1 square oil drain plug socket ■ 10 mm
- 7 male hexagon oil drain plug sockets Ø 8-9-10-11-12-14-17 mm
- 4 male square oil drain plug sockets Ø 8-9,5-12-13 mm
- 1 male triangular oil drain plug socket Δ
- 1 male oil drain plug socket with XZN® profile Ø
- 1 oil plug wrenches
- 2 flat chisels, ribbed type 100 - 200 mm
- 1 engineer's hammer 300 g
- 1 soft face hammer Ø 35 mm
- 1 Slip joint pliers boxed joints 250 mm
- 1 self - locking pliers 240 mm
- 1 half-round needle nose pliers ■ 180 mm
- 1 Extra-long needle nose pliers ● 160 mm
- 1 Heavy-duty diagonal cutting nippers † 160 mm
- 11 3/4" square drive hexagon socket Ø 22-24-27-30-32-34-36-38-41-46-50 mm
- 1 3/4" drive extension bar 200 mm
- 1 3/4" drive extension bar 380 mm
- 1 3/4" drive sliding T - handle 450 mm
- 1 3/4" drive reversible ratchet Ⓞ
- 1 empty thermoformed tray
- 4 offset hexagon key wrenches Ø 13-14-17-19 mm
- 1 adjustable wrench 300 mm
- 1 pry bar with handle
- 1 tin snips 250 mm
- 1 electrician's scissors, straight blades
- 1 engineer's hammer 1000 g
- 1 metric feeler gauge
- 1 telescopic magnet with flexible head
- 1 telescopic joint inspection mirror
- 1 three - cutting edges scraper 200 mm
- 1 hacksaw frame, aluminium handle 440 mm
- 1 Steel wire brush
- 1 metal oil can 200 cl
- 1 snap - off blade utility knife

Beta N. TR

- 920TX T113
- 920XZN T113
- 1719BMA8/S5 T236
- 1491 T264
- 1494 T264
- 1494E T264
- 1494Q T264
- 1494T T264
- 1494XZN T264
- 1496/C T264
- 35 T234
- 1370 T234
- 1390 T234
- 1048 T153
- 1052 T153
- 1150 T138
- 1166 T138
- 1084 T138
- 928A T105
- 928/21 T106
- 928/22 T106
- 928/42 T106
- 928/55 T106
- VP6 VP6
- 96N T111
- 965 T111
- 1112 T112
- 1128BMX T112
- 1370 T137
- 1708/20 T170
- 1712 T171
- 1715 T171
- 1717B T171
- 1726 T172
- 1737NX T173
- 1751 T175
- 1771 T177

Car repairs



Quantity/Description

16	combination wrenches 6÷21 mm
5	combination wrenches 22 - 24 - 27 - 30 - 32 mm
6	double swivel end socket wrenches 8x9 - 10x11 - 12x13 - 14x15 - 16x17 - 18x19 mm
1	adjustable oil filter wrench 110 mm
1	square oil drain plug socket 10 mm
7	male hexagon oil drain plug sockets Ø 8-9-10-11-12-14-17 mm
4	male square oil drain plug sockets Ø 8-9-5-12-13 mm
1	male triangular oil drain plug socket Δ
1	male oil drain plug socket with XZN® profile ○
1	oil plug wrenches
5	1/2" drive, socket drivers for hexagon screws Ø 5 - 6 - 8 - 10 - 12 mm
1	1/2" drive extension bar 125 mm
1	1/2" drive extension bar 255 mm
1	1/2" drive universal joint
1	1/2" drive sliding T-handle
1	1/2" drive reversible ratchet Ⓞ
19	1/2" square drive hexagon sockets ○ 10÷24 - 26 - 27 - 30 - 32 mm
1	circlip pliers straight, internal ○ 180 mm
1	circlip pliers bent, internal ○ 170 mm
1	circlip pliers straight, external ● 175 mm
1	circlip pliers bent, external ● 175 mm
1	circlip pliers straight, internal ○ 140 mm
1	circlip pliers bent, internal ○ 225 mm
1	circlip pliers straight, external ● 140 mm
1	circlip pliers bent, external ● 225 mm
6	drivers for Torx® head screws, with handles ○ T10-T15-T20-T25-T27-T30
12	swivel end ratcheting combination wrenches 8 - 9 - 10 - 11 - 12 - 13 - 14 - 15 - 16 - 17 - 18 - 19 mm
1	half-round needle nose pliers = 180 mm

Beta N.

42NEW	T05
42NEW	T06
80	T79
1491	T264
1494	T264
1494E	T264
1494Q	T264
1494T	T264
1494XZN	T264
1496/C	T264
920ME	T80
920/21	T80
920/22	T80
920/25	T80
920/42	T80
920/55	T80
920A	T80
1032	T145
1034	T145
1036	T145
1038	T145
1032	T146
1034	T146
1036	T146
1038	T146
97TTX	T55
142SN	T46
1150BM	T137

Quantity/Description

1	Extra-long needle nose pliers ● 160 mm
1	Heavy-duty diagonal cutting nippers ⚡ 160 mm
1	slip joint pliers, push button alignment 240 mm
1	self - locking pliers 240 mm
8	T - handle wrenches with swivelling socket ○ 7 - 8 - 10 - 12 - 13 - 14 - 17 - 19 mm
9	screwdrivers for cross head Phillips® screws ● 3x75 - 3,5x100 - 4x100 - 4x150 - 5,5x100 - 5,5x150 - 6,5x150 - 8x150 - 10x200 mm
2	screwdrivers for slotted head screws, extra-short series ● 4x30 - 6,5x30 mm
6	pin punches
7	screwdrivers for cross head Phillips® screws ● PH0x60 - PH0x100 - PH1x80 - PH1x120 - PH2x100 - PH2x150 - PH3x150 mm
2	screwdrivers for cross head Phillips® screws, extra - short series ● PH1x30 - PH2x30 mm
1	adjustable wrench 250 mm
1	1/2" drive swivel T-handle
6	T-handle wrenches with hexagon male ends ○ 2,5-3-4-5-6-8 mm
4	T handle wrenches with swivelling hexagon male ends ○ 4-5-6-8 mm
2	engineer's hammer 300-500 g
2	screwdriver for cross head Phillips® screws, long series ● PH1x400 - PH2x400 mm
3	screwdriver for headless slotted screws, long series ● 3x300 - 4x400 - 5x400 mm
9	ball head offset hexagon key wrenches ○ 96BPC/SC9
1	click-type torque wrenches with reversible ratchets Ⓞ 8 ÷ 60 Nm
1	click-type torque wrenches with reversible ratchets Ⓞ 60 ÷ 330 Nm
12	impact sockets
1	adaptor, 1/2" female and 3/8" male drives
1	assortment of 12 sockets and 5 accessories 3/4"
3	lever with articulated, flat, curved head
1	dead blow hammer Ø 50 mm
1	Reversible impact wrench, made from composite material Ⓞ 1927P

Beta N.

1166BM	T137
1084BM	T137
1047	T151
1057A	T151
952	T63
1260N	T167
31/B6	T167
1262	T168
1262N	T168
111	T59
920/40	T59
951	T59
953	T59
1370	T59
1262L	T209
1264L	T209
666N/5	T209
666N/30	T209
720/C12	T209
910/16	T209
928A/C12	T209
966/C3	T209
1392	T209
1927P	T209

5935VG/1MB

assortment of 98 tools for tool chest C35, in EVA foam trays

Car repairs



MB12



MB39



MB46

Quantity/Description

21	combination wrenches 6-7-8-9-10-11-12-13-14-15-16-17-18-19-20-21-22-24-27-30-32 mm	42NEW	MB12
8	double open end wrenches 6x7-8x9-10x11-12x13-14x15-16x17-18x19-20x22 mm	55	MB12
1	Slip joint pliers boxed joints 250 mm	1048	MB12
4	screwdrivers for cross head Phillips® screws 3x75-4x100-5x125-6,5x150 mm	1260	MB46
3	screwdrivers for cross head Phillips® screws PH0x60-PH1x80-PH2x100 mm	1262	MB46
6	drivers for Torx® head screws T8-T10-T15-T20-T25-T30	1267TX	MB46
9	ball head offset hexagon key wrenches 2	96BPC/SC9	MB46
6	offset hexagon key wrenches 2-2,5-3-4-5-6	96T	MB46
1	self - locking pliers 240 mm	1052	MB46
19	1/2" square drive hexagon sockets 10-11-12-13-14-15-16-17-18-19-20-21-22-23-24-26-27-30-32 mm	920A	MB39
1	1/2" drive extension bar 125 mm	920/21	MB39
1	1/2" drive extension bar 250 mm	920/22	MB39

Beta N. TR

Quantity/Description

1	1/2" drive universal joint	920/25	MB39
1	1/2" drive sliding T-handle	920/42	MB39
1	1/2" drive reversible ratchet	920/55	MB39
5	socket drivers for hexagon screws 5-6-8-10-12 mm	920PE	MB39
1	circlip pliers straight, internal 180 mm	1032	MB39
1	circlip pliers bent, internal 170 mm	1034	MB39
1	circlip pliers straight, external 175 mm	1036	MB39
1	circlip pliers bent, external 175 mm	1038	MB39
1	flat chisels, ribbed type 200 mm	35	MB39
1	Heavy-duty diagonal cutting nippers 160 mm	1084BM	MB39
1	half-round needle nose pliers 180 mm	1150BM	MB39
1	Extra-long needle nose pliers 160 mm	1166BM	MB39
1	engineer's hammer 500 g	1370	MB39
1	soft face hammer 35 mm	1390	MB39

Beta N. TR

920/25	MB39
920/42	MB39
920/55	MB39
920PE	MB39
1032	MB39
1034	MB39
1036	MB39
1038	MB39
35	MB39
1084BM	MB39
1150BM	MB39
1166BM	MB39
1370	MB39
1390	MB39

5935VG/1MB

059351321

Assortment recommended in combination with C35

Motorcycle repairs

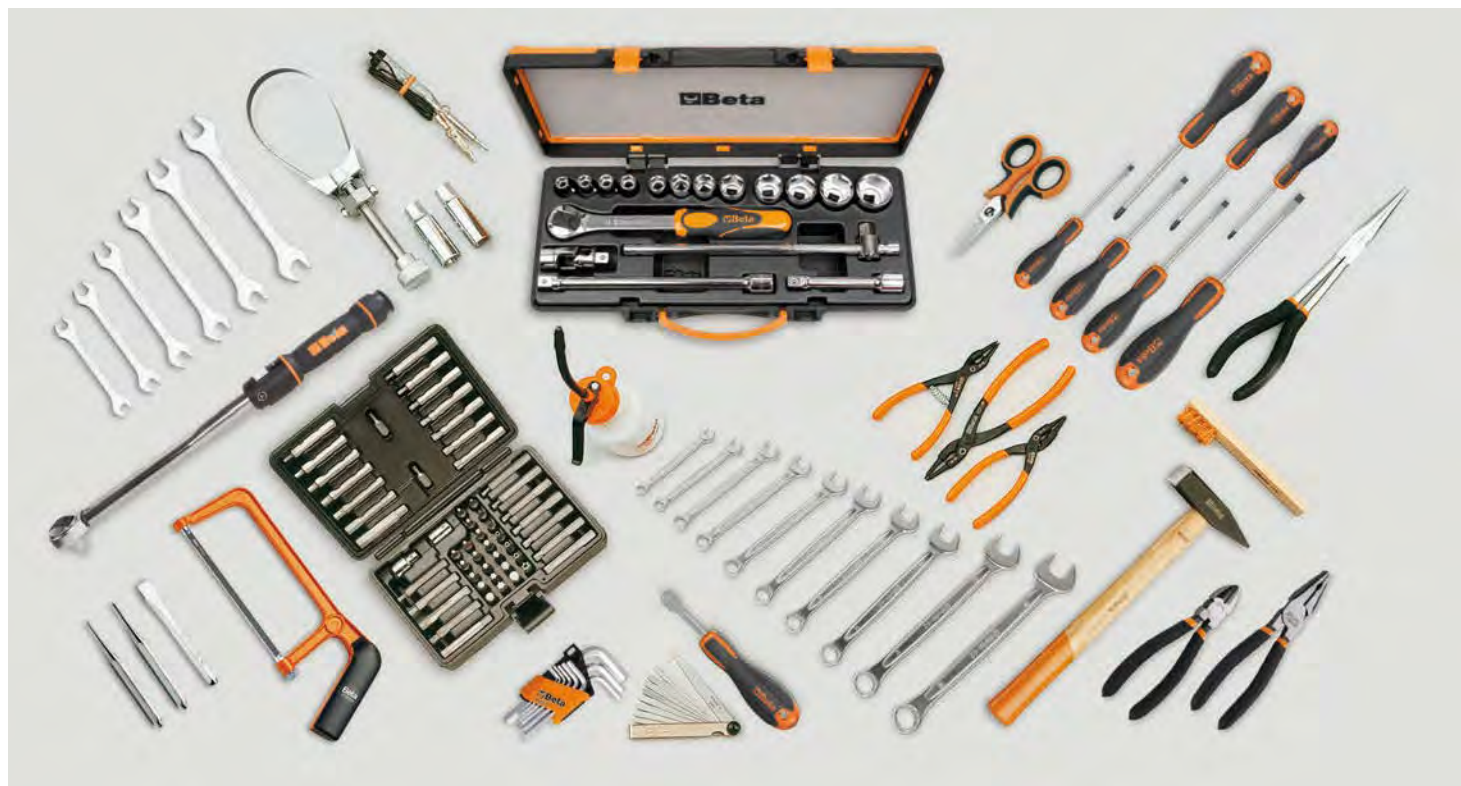

Quantity/Description

- 1 drift punches Ø 2 mm
- 1 centre punch Ø 4 mm
- 1 flat chisels 125 mm
- 10 combination wrenches 6 - 7 - 8 - 10 - 11 - 12 - 13 - 14 - 17 - 19 mm
- 6 double open end wrenches
6x7 - 8x9 - 10x11 - 12x13 - 14x15 - 16x17 mm
- 9 offset hexagon key wrenches \odot 1,5 - 2 - 2,5 - 3 - 4 - 5 - 6 - 8 - 10 mm
- 1 click-type torque wrenches with reversible ratchets \odot 3/8", 8+60 Nm
- 54 assortment of 52 hexagon bits, 10 mm, and 2 accessories
- 17 assortment of 12 sockets and 5 accessories
- 1 adaptor, 1/2" female and 3/8" male drives
- 2 spark plug socket \odot 14 - 16 mm
- 1 extra - long nose pliers \bullet 283 mm
- 2 circlip pliers straight, internal \odot 140 - 180 mm

Beta N.

- 30
- 32
- 34
- 42NEW
- 55
- 96/SC9
- 666N/5
- 867/C52
- 920A/C12X
- 910/16
- 956C
- 1009L/A
- 1032

Quantity/Description

- 1 circlip pliers straight, external \bullet 140x1,3 mm
- 1 diagonal cutting nippers, slip-proof double layer PVC coated handles, industrial finish ∇ 160 mm
- 1 electrician's scissors, straight blades
- 1 heavy duty combination pliers, slip-proof double layer PVC coated handles, industrial finish \equiv 180 mm
- 1 screwdriver for Dzus® head screws \bullet
- 4 screwdriver for slotted head screws \bullet 3x75 - 4x100 - 5,5x100 - 6,5x150 mm
- 3 screwdriver for cross head Phillips® screws \oplus PH0x60 - PH1x80 - PH2x100 mm
- 1 circuit testing screwdriver \bullet
- 1 engineer's hammer 300 g
- 1 adjustable oil filter wrench
- 1 metric feeler gauge
- 1 mini hacksaw frame
- 1 Brass wire brush
- 1 plastic oil can 250 cc

Beta N.

- 1036
- 1082G
- 1128BM
- 1150G
- 1201E/DZ
- 1201E
- 1202E
- 1254
- 1370
- 1491
- 1708/13
- 1725CR
- 1737
- 1754

5940SBK

059401082

Assortment recommended for use with items C41S - C41H - C42S - C42H - C42S - C41S

5941VU/M

assortment of 64 tools for trolley C41H, in EVA foam trays

Universal use



Quantity/Description	Beta N.	TR	Quantity/Description	Beta N.	TR
16 combination wrenches 6-7-8-9-10-11-12-13-14-15-16-17-18-19-21-22 mm	42NEW	MC12	1 160 mm	1082GBM	
9 offset hexagon key wrenches ○	96/SC9	MC12	1 electrician's scissors, straight blades 145 mm	1128BMX	
1 measuring tape 5 m	1692/5	MC12	1 heavy duty combination pliers, bi-material handles, industrial finish = 180 mm	1150GBM	
19 1/2" square drive hexagon sockets ○ 10-11-12-13-14-15-16-17-18-19-20-21-22-23-24-26-27-30-32 mm	920A	MC21	1 extra-long needle knurled nose pliers, bi-material handles, industrial finish ● 160 mm	1166GBM	
1 1/2" drive universal joint	920/25	MC21	3 screwdrivers for cross head Phillips® screws ● 3,5x100-5,5x125-6,5x150 mm	1260	
1 1/2" drive sliding T-handle	920/42	MC21	3 screwdrivers for cross head Phillips® screws ⊕ PH0-PH1-PH2	1262	
1 1/2" drive reversible ratchet ⊕	920/55	MC21	1 engineer's hammer 300 g	1370	
2 1/2" wobble extension bar 125-250 mm	920AN	MC21	1 snap - off blade utility knife 18 mm	1771	
1 adjustable wrench 250 mm	111				
1 Slip joint pliers boxed joints 250 mm	1048				

5941VU/M

059411002

Assortment recommended in combination with C41H

Universal use



MM11



MM61



MM105



MM140



MM210

Quantity/Description

- 21 combination wrenches 6-7-8-9-10-11-12-13-14-15-16-17-18-19-20-21-22-24-27-30-32 mm
- 8 offset hexagon key wrenches \odot 2-2,5-3-4-5-6-7-8 mm
- 5 drivers for Torx® head screws, with handles \odot T10-T15-T20-T25-T30
- 1 engineer's hammer 300 g
- 1 soft face hammer \varnothing 35
- 2 flat chisels, ribbed type 100-200 mm
- 5 second cut files 200 mm
- 9 ball head offset hexagon key wrenches \odot 1,5-2-2,5-3-4-5-6-8-10 mm
- 1 socket holder \square 1/4 - \square 1/4
- 1 socket holder \square 1/4 - \square 3/8
- 1 socket holder \square 5/16 - \square 1/2
- 13 1/4" hexagon sockets \odot 4-4,5-5-5,5-6-7-8-9-10-11-12-13-14 mm
- 9 hexagon hand sockets, long series \odot 5-6-7-8-9-10-11-12-13 mm
- 5 1/4" socket drivers for hexagon screws \odot 3-4-5-6-7 mm
- 4 socket drivers for slotted head screws \bullet 0,8x4-1x5,5x1,2x6,5-1,2x8 mm
- 4 socket drivers for cross head Phillips® screws \bullet PH1-PH2-PH3-PH4
- 7 socket drivers for Torx® head screws \odot T10-T15-T20-T25-T27-T30-T40
- 1 adaptor, 1/4" female and 3/8" male drives \square 1/4 - \blacksquare 3/8
- 1 1/4" drive extension bar 50 mm
- 1 1/4" drive extension bar 100 mm
- 1 1/4" drive extension bar 150 mm
- 1 1/4" drive universal joint
- 1 1/4" drive spinner handle 176 mm
- 1 1/4" drive swivel T-handle 115 mm
- 1 1/4" reversible ratchet \odot 125 mm
- 17 hexagon hand sockets 3/8" \odot 6-7-8-9-10-11-12-13-14-15-16-17-18-19-20-21-22 mm
- 1 adaptor, 3/8" female and 1/4" male drives \square 3/8 - \blacksquare 1/4
- 1 adaptor, 1/2" female and 3/8" male drives \square 3/8 - \blacksquare 1/2
- 1 extension bar - 3/8" 125 mm
- 1 extension bar - 3/8" 250

Beta N. TR

- 42NEW **MM11**
- 96T **MM61**
- 97TTX **MM140**
- 1370 **MM61**
- 1390 **MM61**
- 35 **MM61**
- 1719BMA8/S5 **MM61**
- 96BPC/SC9 **MM10**
- 895/1 **MM105**
- 895/3 **MM105**
- 895/6 **MM105**
- 900 **MM105**
- 900L **MM105**
- 900ME **MM105**
- 900LP **MM105**
- 900PH **MM105**
- 900TX **MM105**
- 900/16 **MM105**
- 900/20 **MM105**
- 900/20L **MM105**
- 900/21 **MM105**
- 900/25 **MM105**
- 900BG/30 **MM105**
- 900/42 **MM105**
- 900/55 **MM105**
- 910A **MM105**
- 910/15 **MM105**
- 910/16 **MM105**
- 910/21 **MM105**
- 910/22 **MM105**

Quantity/Description

- 1 3/8" drive universal joint
- 1 3/8" drive sliding T - handle 210 mm
- 1 3/8" drive reversible ratchet \odot 200 mm
- 21 1/2" square drive hexagon sockets \odot 8-10-11-12-13-14-15-16-17-18-19-20-21-22-23-24-26-27-28-30-32 mm
- 1 adaptor, 1/2" female and 3/8" male drives \square 1/2 - \blacksquare 3/8
- 1 1/2" drive universal joint
- 1 1/2" wobble extension bar 125 mm
- 1 1/2" wobble extension bar 250 mm
- 1 1/2" drive sliding T-handle 305 mm
- 1 1/2" drive reversible ratchet \odot 275 mm
- 3 3/8" square drive spark plug sockets \odot 16 mm (5/8")-17,8 (11/16")-20,8 (13/16")
- 1 Heavy-duty diagonal cutting nippers \leq 160 mm
- 1 half-round needle nose pliers \equiv 180 mm
- 1 Extra-long needle nose pliers \bullet 160 mm
- 1 circlip pliers straight, internal \odot 19+60 mm
- 1 circlip pliers bent, internal \odot 19+60 mm
- 1 circlip pliers straight, external \bullet 19+60 mm
- 1 circlip pliers bent, external \bullet 19+60 mm
- 1 Slip joint pliers boxed joints 250 mm
- 1 self - locking pliers 240 mm
- 38 microscrewdriver with 36 interchangeable 4-mm bits and magnetic extension
- 6 screwdriver for slotted head screws \bullet 04x2,5x50-0,5x3x75-0,8x4x100-1,0x5,5x125-1,2x6,5x150-1,2x8x200 mm
- 1 screwdriver for slotted head screws, extra-short series \bullet 0,8x4x30 mm
- 4 screwdriver for cross head Phillips® screws \bullet PH0x60-PH1x80PH2x100PH3x150 mm
- 1 screwdriver for cross head Phillips® screws, extra-short series \bullet PH1x30 mm
- 12 screwdrivers for Torx® head screws, with handles \odot T06-T07-T08-T09-T10-T15-T20-T25-T27-T30-T40-T45
- 1 mains testing screwdriver \bullet 0,5x3,5x100 mm

Beta N. TR

- 910/25 **MM105**
- 910/42 **MM105**
- 910/55 **MM105**
- 920A **MM105**
- 920/15 **MM105**
- 920/25 **MM105**
- 920AN **MM105**
- 920AN **MM105**
- 920/42 **MM105**
- 920/55 **MM105**
- 956E **MM105**
- 1084BM **MM140**
- 1150BM **MM140**
- 1166BM **MM140**
- 1032 **MM140**
- 1034 **MM140**
- 1036 **MM140**
- 1038 **MM140**
- 1048 **MM140**
- 1052 **MM140**
- 1256/C36-2 **MM140**
- 1201E **MM210**
- 1201EN **MM210**
- 1202E **MM210**
- 1202EN **MM210**
- 1207E/TX **MM210**
- 1253 **MM210**

Car repairs



18.9 kg

Quantity/Description

5	pin punches Ø 2-3-4-5-6 mm
1	centre punch Ø 4 mm
1	flat chisels 125 mm
18	combination wrenches 6+22 - 24 mm
8	double open end wrenches 6x7 - 8x9 - 10x11 - 12x13 - 14x15 - 16x17 - 18x19 - 20x22 mm
3	double ended offset ring wrenches 12x13 - 14x15 - 17x19 mm
13	offset hexagon key wrenches 2+10 - 12 mm
4	1/2" drive impact sockets 17 - 19 - 21 - 22 mm
20	1/2" square drive hexagon sockets 10-11-12-13-14-15-16-17-18-19-20-21-22-23-24-26-27-28-30-32 mm
1	1/2" drive extension bar
1	1/2" drive extension bar
1	1/2" drive universal joint
1	1/2" drive sliding T-handle
1	1/2" drive reversible ratchet
3	hi-torque hexagon nut spinners, long series 8 - 10 - 13 mm
10	T - handle wrenches with swivelling socket 6 - 7 - 8 - 10 - 11 - 12 - 13 - 14 - 17 - 19 mm
3	spark plug socket 16 - 17,8 - 20,8 mm
1	pry bar
1	circlip pliers straight, internal
1	circlip pliers bent, internal
1	circlip pliers straight, external
1	circlip pliers bent, external
1	Slip joint pliers boxed joints 250 mm
1	self - locking pliers 240 mm

Beta N.

31
32
34
42NEW
55
90
96
720
920A
920/21
920/22
920/25
920/42
920/55
943BX
952
956C
964
1032
1034
1036
1038
1048
1052

Quantity/Description

1	adjustable self locking pliers, long jaws 175 mm
1	Diagonal cutting nippers 160 mm
1	electrician's scissors, straight blades
1	half-round needle nose pliers 180 mm
1	Extra-long needle nose pliers 160 mm
1	circuit testing screwdriver 6+24V
1	screwdrivers for cross head Phillips® screws 8 x 200 mm
1	screwdrivers for slotted head screws, extra-short series 6,5x30 mm
1	screwdrivers for cross head Phillips® screws 8 x 150 mm
1	screwdrivers for cross head Phillips® screws, extra - short series PH2x30 mm
5	drivers for Torx® head screws T8 - T10 - T15 - T20 - T25
8	set of screwdrivers
1	engineer's hammer 300 g
1	dead blow hammer Ø 35 mm
1	brake spring pliers 210 mm
1	crimping pliers for non insulated terminals
1	measuring tape 5 m
1	metric feeler gauge
1	flexible magnetic pick-up tool 1,8 kg
6	needle files 160 mm
1	plastic oil can 150 cc

Beta N.

1058
1082BM
1128BMX
1150BM
1166BM
1254
1260
1260N
1262
1262N
1267TX
1263/D8
1370
1392
1470
1603
1692
1708/20
1712E/2
1720/B6
1754

5954VG

059541054

Assortment recommended in combination with C54VG

Car repairs



36.6 kg

Quantity/Description

6	pin punches Ø 2 - 3 - 4 - 5 - 6 - 8 mm	31/SP6
6	2 drift punches, 1 centre punch, 3 flat chisels with metal holder	38/SP6
17	combination wrenches 6-7-8-10-11-12-13-14-15-16-17-19-21-22-24-27-30 mm	42NEW
12	double open end wrenches 6x7 ÷ 30x32 mm	55/S12X
8	offset hexagon key wrenches 2 ÷ 10 mm	96T/S8
1	offset hexagon key wrenches Ø 2,5 ÷ 12 mm	96N/G7
8	offset key wrenches, for Torx® head screws T9 ÷ T40	97TX/SC8
5	offset key wrenches with XZN® profile O M5 ÷ M12	98XZN/B5
1	adjustable wrench 250 mm	111
1	click-type torque wrenches with reversible ratchets ⊕ 1/2", 40÷200 Nm	666N/20
13	1/2" square drive hexagon sockets with rail ○ 10÷22 mm	920A/SB13
8	1/2" square drive hexagon sockets with rail ○ 23÷32 mm	920A/SB8
4	1/2" socket drivers for slotted head screws ● 1,2x6,5 - 1,2x8 - 1,6x9 - 2x12 mm	920LP
3	1/2" socket drivers for Phillips® screws ⊕ PH2 - 3 - 4	920PH
1	1/2" drive extension bar 125 mm	920/21
1	1/2" drive extension bar 255 mm	920/22
1	1/2" drive universal joint	920/25
1	1/2" drive sliding T-handle	920/42
1	1/2" drive reversible ratchet ⊕	920/55
2	1/2" drive impact sockets ○ 17 - 19 mm	720
10	T - handle wrenches with swivelling socket ○ 7 - 8 - 10 - 11 - 12 - 13 - 14 - 15 - 17 - 19 mm	952
3	T - handle swivel spark plug wrenches 14 - 16 - 20,8 mm	959
1	pry bar	963
1	wheel nut wrench ○ ■ 1/2" - 17 - 19 - 22 mm	979
2	circlip pliers straight, internal ○ 140 - 180 mm	1032
2	circlip pliers bent, internal ○ 130 - 170 mm	1034
2	circlip pliers straight, external ● 140x1,3 - 175 mm	1036

Quantity/Description

2	circlip pliers bent, external ● 135x1,3 - 175 mm	1038
1	Slip joint pliers boxed joints 250 mm	1048
1	self - locking pliers 240 mm	1052
1	Diagonal cutting nippers < 160 mm	1082BM
1	Heavy-duty diagonal cutting nippers < 160 mm	1084BM
1	toggle lever assisted end cutting nippers < 180 mm	1092V
1	tin snips 250 mm	1112
1	electrician's scissors, straight blades	1128BMX
1	half-round needle nose pliers = 180 mm	1150BM
1	Extra-long needle nose pliers ● 160 mm	1166BM
1	Extra-long bent needle nose pliers ● 200 mm	1168BM
2	screwdrivers for cross head Phillips® screws ● 8x200 - 10x200 mm	1260
1	screwdrivers for cross head Phillips® screws ⊕ PH3x150 mm	1262
8	set of screwdrivers	1263/D8
2	engineer's hammer 300 - 600 g	1370
1	soft face hammer Ø 35 mm	1390
11	roller stud extractors M5÷M16 mm	1433/C11
1	adjustable oil filter wrench	1491
1	circuit tester	1498
1	measuring tape 5 m	1692
1	metric feeler gauge	1708/20
1	flexible magnetic pick-up tool 1,8 kg	1712E/2
1	two cutting edges scraper 200 mm	1717A
1	three - cutting edges scraper 200 mm	1717B
5	second cut files 200 mm	1719BMA8/S5
1	hacksaw frame, aluminium handle	1725
1	metal oil can 200 cc	1751
1	snap - off blade utility knife	1771
1	sliding gauge	1650













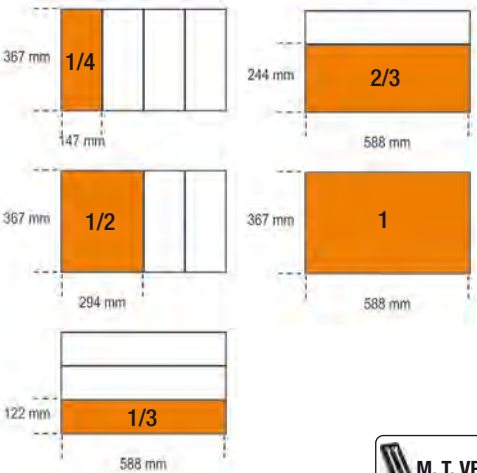

5957VG

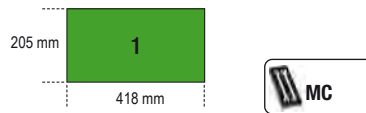
059571007

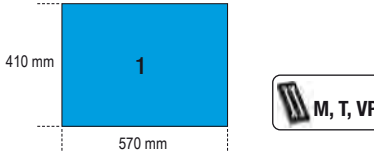
Assortment recommended for use with items C57S A - C57S B - C57SP - C55PSP

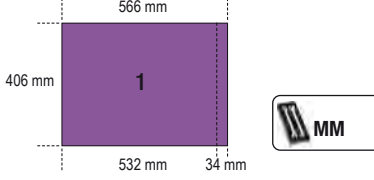
SOFT MODULES

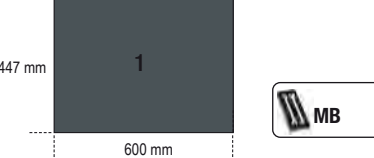
Assortment of tools in thermoformed trays,
designed for roller cabs

		
C23ST C24S C24SA C24SA-XL C24SL C28 C30S C37 C39 C39T C39MD C39SM C57S C59 RSC55	 <div style="text-align: right; border: 1px solid black; padding: 2px; display: inline-block;">  </div>	471÷480 485÷495
C22S C23S C23SC C27S	 <div style="text-align: right; border: 1px solid black; padding: 2px; display: inline-block;">  </div>	481 495
C41S C41H	 <div style="text-align: right; border: 1px solid black; padding: 2px; display: inline-block;">  </div>	481
C04TSS C38 C38T	 <div style="text-align: right; border: 1px solid black; padding: 2px; display: inline-block;">  </div>	485 495
C45	 <div style="text-align: right; border: 1px solid black; padding: 2px; display: inline-block;">  </div>	484
C35	 <div style="text-align: right; border: 1px solid black; padding: 2px; display: inline-block;">  </div>	481÷483



M01

22



42NEW 6-7-8-9-10-11-12-13-14-15-16-17-18-19-20-21-22-24-27-30-32-36 mm

1.5 kg



M01	1	024500001
MV10	1	024510010

M02

26



42NEW 6-7-8-9-10-11-12-13-14-15-16-17-18-19-20-21-22-23-24-25-26-27-28-29-30-32 mm

1.5 kg



M02	1	024500002
MV02	1	024510002

M05

16



42NEW 6-7-8-9-10-11-12-13-14-15-16-17-18-19-20-21 mm

1.5 kg



M05	1	024500005
MV15	1	024510015

M06

5



42NEW 22-24-27-30-32 mm

2.1 kg



M06	1	024500006
MV16	1	024510016

M13

11



42SLIM 8-10-11-12-13-14-15-16-17-18-19 mm

1.2 kg



M13	1	024500013
MV13	1	024510013

M25

40



42NEW 6-7-8-9-10-11-12-13-14-15-16-17-18-19-21-22-24-27 mm
90 6x7-8x9-10x11-12x13-14x15-16x17-18x19 mm

123Q1/4

123Q3/8

123Q1/2

142

8-9-10-11-12-13-14-15-16-17-18-19 mm

5.1 kg



M25	1	024500025
MV25	1	024510873

M30

31



55 6x7-8x9-10x11-12x13-14x15-16x17-18x19-20x22-21x23-24x27-30x32 mm
90 6x7-8x9-10x11-12x13-14x15-16x17-18x19-20x22-21x23-24x27-30x32 mm
96BPC/SC9 1,5-2-2,5-3-4-5-6-8-10 mm

4.2 kg



M30	1	024500030
MV30	1	024510030



M31

27



42AS 1/4-9/32-5/16-3/8-7/16-1/2-9/16-19/32-5/8-11/16-3/4-13/16-7/8-15/16-1-1.1/16-1.1/8-1.1/4
96BP/AS-SC9 1/16-3/32-1/8-5/32-3/16-7/32-1/4-5/16-3/8

4.5 kg



M31	1	024500031
MV31	1	024510031

M33

17



55 6x7-8x9-10x11-12x13-14x15-16x17-18x19-20x22 mm
96/SC9 1,5+10 mm

1.1 kg



M33	1	024500033
MV33	1	024510033

M38

4



55 21x23-24x26-27x29-30x32 mm

1.7 kg



M38	1	024500038
MV38	1	024510038

M39

36



- 31 2-3-4-5-6-8 mm
- 32 4 mm
- 55 6x7-8x9-10x11-12x13-14x15-16x17-18x19-20x22-21x23-24x26-25x28-27x29-30x32 mm
- 96/SC12 2-2,5-3-3,5-4-4,5-5-6-7-8-9-10 mm
- 96 12-14-17-19 mm

5,7 kg



- M39 1 024500039
- MV39 1 024510039

M40

7



- 90 6x7-8x9-10x11-12x13-14x15-16x17-18x19 mm

810 g



- M40 1 024500040
- MV40 1 024510040

M44

12



- 141 8-9-10-11-12-13-14-15-16-17-18-19 mm

1,3 kg



- M44 1 024500044
- MV44 1 024510044

M45

12



- 142 8-9-10-11-12-13-14-15-16-17-18-19 mm

1,3 kg



- M45 1 024500045
- MV45 1 024510045

M46

12



- 142SN 8-9-10-11-12-13-14-15-16-17-18-19 mm

1,4 kg



- M46 1 024500046
- MV46 1 024510046

M49

24

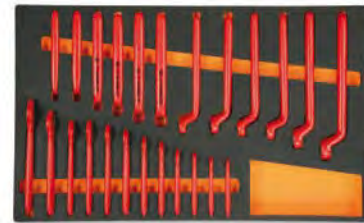

- 52MQ 7-8-10-11-12-13-14-15-16-17-19-22 mm
- 89MQ 7-8-10-11-12-13-14-15-16-17-19-22 mm

3,3 kg



- M49 1 024500049
- MV49 1 024510049

M50

8



- 96T 2-2,5-3-4-5-6-7-8 mm

1,1 kg



- M50 1 024500050
- MV50 1 024510051

M52

5



- 96T 2,5-3-4-5-6 mm

330 g



- M52 1 024500052
- MV52 1 024510052

M53

5



- 96TBP 2,5-3-4-5-6 mm

350 g



- M53 1 024500053
- MV52 1 024510052

M55

5



- 97TTX T10-T15-T20-T25-T30

330 g



- M55 1 024500055
- MV55 1 024510055



M60

24



- 96T 2-2,5-3-4-5-6-7-8-10 mm
- 97BTX/SC8 T9-T10-T15-T20-T25-T27-T30-T40
- 944BX 5-6-7-8-10-13 mm

1,9 Kg

M60	1	024500060
MV60	1	024510060

M62

21



- 97TTX T10-T15-T20-T25-T27-T30-T40-T45-T50
- 1032 180 mm
- 1034 170 mm
- 1036 175 mm
- 1038 175 mm
- 1177BM 140 mm
- 1188BM 125 mm
- 1257LP 2-2,5-3-3,5 mm
- 1257PH 0-00

2,3 kg

M62	1	024500875
MV62	1	024510875

M63

8



- 952 7-8-10-12-13-14-17-19 mm

3,4 kg

M63	1	024500063
MV63	1	024510063

M65

16

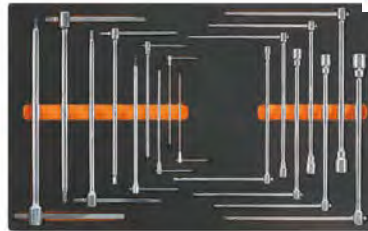

- 950 8-10-12-13-14-17-19 mm
- 951 2,5-3-4-5-6-8-10-12-14 mm

3,6 Kg

M65	1	024500065
MV65	1	024510065

M69

9



- 951 2,5-3-4-5-6-8-10-12-14 mm

1,8 kg

M69	1	024500069
MV69	1	024510069

M75

16



- 933 7-8-9-10-11-12-13-14-15-16-17-18-19-21-22-24 mm

5,5 kg

M75	1	024500075
MV75	1	024510075

M78

17



- 80 6x7-8x9-10x11-12x13-14x15-16x17-18x19 mm

920/36A

- 965 450 mm
- 1052 240 mm
- 1058 175 mm
- 1481PL/A
- 1481PL/B
- 1481PL/C
- 1650 150 mm
- 1708/20
- 1716P

4,4 kg

M78	1	024500878
MV77	1	024510876

M79

6



- 80 8x9-10x11-12x13-14x15-16x17-18x19 mm

1,3 kg

M79	1	024500079
MV79	1	024510079

M82

29



- 920A 10-11-12-13-14-15-16-17-18-19-20-21-22-23-24-26-27-30-32 mm
- 920ME 5-6-8-10-12 mm
- 920AN/125 125 mm
- 920AN/250 250 mm
- 920/25
- 920/42 305 mm
- 920/55

4,1 kg

M82	1	024500082
MV82	1	024510082



M83



- 920A 10-11-12-13-14
15-16-17-18-19
20-21-22-23-24
26-27-30-32 mm
- 920AN/125 125 mm
- 920AN/250 250 mm
- 920/25 255 mm
- 920/42 305 mm
- ⊕ 920/55

3,7 kg 12"

M83 1 024500083
MV83 1 024510083

M85



- 851SR 230 mm
- 860LP 0,5x3 - 0,6x4,5
- 0,8x5,5 - 1x5,5 -
1,2x6,5 mm
- 860PE 2 - 2,5 - 3 - 4 - 5 - 6 - 8
- 10 mm
- ⊕ 860PH PH0 - PH1 - PH2 -
PH3 - PH4
- ⊕ 860PZ PZ1 - PZ2 - PZ3 - PZ4
- ⊕ 860TX T6-T7-T8-T9-T10-T15-
T20-T25-T27-T30-T40
- ⊕ 860RTX T9-T10-T15-T20-T25-
T27-T30-T40
- 860/55 100 mm
- 882P 80 mm
- 892 ■ 1/4 - □ 1/4

450 g 1/4

M85 1 024500085
MV85 1 024510085

M86



- 867PE 4-5-6-7-8-10-12 mm
- 867PE/L 4-5-6-7-8-10-12 mm
- 867XZN 5-6-8-10-12 mm
- 867XZN/L 5-6-8-10-12 mm
- ⊕ 867TX T20-T25-T30-T40-
T45-T50-T55
- ⊕ 867TX/L T25-T30-T40-T45-
T50-T55
- ⊕ 867RTX T20-T25-T30-T40-
T45-T50-T55
- 867/1
- 867/2

1,4 kg 10"

M86 1 024500086
MV86 1 024510086

M91



- 900 4-4,5-5-5,5-6-7-8-9-
10-11-12-13-14 mm
- 900ME 2,5-3-4-5-6-8 mm
- 900/20 50 mm
- 900/21 150 mm
- 900/25 □ 1/4 - ■ 1/4
- 900BG/30
- 900/42
- ⊕ 900/55

560 g 1/4"

M91 1 024500091
MV90 1 024510090

M92



- 910A 6-7-8-9-10-11-12-13-
14-15-16-17-18-19-20-
21-22 mm
- 910/21 125 mm
- 910/22 250 mm
- 910/25
- 910/42
- ⊕ 910/55

1,5 kg 3/8"

M92 1 024500092
MV92 1 024510092

M94



- 900AS/L 3/16-7/32-1/4-9/32-
5/16-11/32-3/8-7/16-
1/2-9/16
- 900AS 3/16-7/32-5/32-1/4-
9/32-5/16-11/32-3/8-
7/16-1/2-9/16
- 900AN 50-100mm
- 900/25
- ⊕ 900/55
- 900/42

930 g 1/4"

M94 1 024500094
MV94 1 024510094

M96



- 920A/AS 3/8-7/16-1/2-9/16-
19/32-5/8-11/16-3/4-
25/32-13/16-7/8-
15/16-1-1.1/16-1.1/18-
1.3/16-1.1/4
- 920/25
- 920AN 125-250mm
- 920/42
- ⊕ 920/55

3,8 kg 12"

M96 1 024500096
MV96 1 024510096

M100



- 895/1
- 895/3
- 895/6
- 900 4-4,5-5-5,5-6-7-8-9-10-11-12-13-14 mm
- 900L 5-6-7-8-9-10-11-12-13 mm
- 900ME 3-4-5-6-7 mm
- 900LP 0,8x4-1x5,5-1,2x6,5-1,2x8 mm
- ⊕ 900PH PH1-PH2-PH3-PH4
- ⊕ 900TX T10-T15-T20-T25-T27-T30-T40
- 900/20 50 mm
- 900/20L 100 mm
- 900/21 150 mm
- 900/25
- 900BG/30
- 900/42
- ⊕ 900/55
- 920A 8-10-11-12-13-14-15-16-17-18-19-20
21-22-23-24-26-27-28-30-32 mm
- 920/15
- 920/25
- 920AN/125 125 mm
- 920AN/250 250 mm
- 920/42
- ⊕ 920/55
- 920FTX 10-12-14-16-18-20-22-24 mm
- 920AL 10-12-13-14-15-16-17-18-19-21-22

6,7 kg 1/4" 12"

M100 1 024500100
MV100 1 024510100





- 900 4-4,5-5-5,5-6-7-8-9-10-11-12-13-14 mm
- 900L 5-6-7-8-9-10-11-12-13 mm
- 96BPC/SC9 1,5-2-2,5-3-4-5-6-8-10 mm
 - 895/1
 - 895/3
 - 895/6
- 900ME 3-4-5-6-7 mm
- 900LP 0,8x4-1x5,5-1,2x6,5-2x8 mm
- ⊕ 900PH PH1-PH2-PH3-PH4
- ⊕ 900TX T10-T15-T20-T25-T27-T30-T40
- 900/16 □ 1/4 - ■ 3/8
- 900... 50-100-150 mm
- 900/25
- 900BG/30
- 900/42
- ⊕ 900/55
- 910A 6-7-8-9-10-11-12-13-14-15-16-17-18-19-20-21-22 mm
 - 910/15 □ 3/8 - ■ 1/4
 - 910/16 □ 3/8 - ■ 1/2
 - 910/21 125 mm
 - 910/22 250 mm
 - 910/25
 - 910/42
 - ⊕ 910/55
- 920A 8-10-11-12-13-14-15-16-17-18-19-20-21-22-23-24-26-27-28-30-32 mm
 - 920/15 □ 1/2 - ■ 3/8
 - 920/25
 - 920AN 125 - 250 mm
 - 920/42
 - ⊕ 920/55
- 956E 16-17,8-20,8 mm

7,7 kg 14" 38" 12"

M105	1	024500871
MV105	1	024510871



- ⊕ 861TX ● 1/4-T6+T15
- ⊕ 866TX ● 5/16-T20+T55
- 895/1 ○ 1/4x□1/4
- 895/6 ○ 5/16x□1/2
- ⊕ 900FTX □ 1/4-E4+E10
- ⊕ 920FTX □ 1/2-E12+E24
- ⊕ 920TX □ 1/2-T55L-T60-T70L

1,3 kg 14" 12"

M112	1	024500112
MV112	1	024510112



- ⊕ 666N 40=200 Nm
- 920A 13-14-15-16-17-18-19-20-21-22-24-26-27-30-32 mm
- ⊕ 920FTX 12-14-16-18-20-22-24 mm
- 920PE 6-7-8-8L-10-10L-12-12L-14-14L
- ⊕ 920TX T20-T25-T27-T30-T40-T45-T50-T55-T60-T20L-T25L-T27L-T30L-T40L-T45L-T50L
- 920/21 125 mm
- 920/22 255 mm
- 920/25
- 920/42 305 mm
- ⊕ 920/55

7,8 kg 12"

M115	1	024500115
MV115	1	024510115



- 920A 10-11-12-13-14-15-16-17-18-19-20-21-22-24-26-27-30-32 mm
- 920AN/125 125 mm
- 920AN/250 250 mm
- 920/25
- 920/42
- 920AL 10-12-13-14-15-16-17-18-19-22-24-27-30-32 mm
- ⊕ 920FTX 10-12-14-16-18-20-22-24 mm
- ⊕ 920/55
- 920PE 5-5L-6-6L-7-7L-8-8L-10-10L-12-12L-14-14L
- ⊕ 920TX T20-T25-T27-T30-T40-T45-T50-T55-T60-T20L-T25L-T27L-T30L-T40L-T45L-T50L

6,9 kg 12"

M120	1	024500120
MV120	1	024510120



- 910MQ/PE 4-5-6-8 mm
- 910MQ/B 7-8-10-11-12-13-14-15-16-17-19 mm
- ⊕ 910MQ/TX T15-T20-T25-T27-T30-T40
- 910MQ/XZN 8-10 mm
- 910MQ/21 125 mm
- 910MQ/22 250 mm
- 910MQ/T
- 910MQ/55

2,7 kg

M108	1	024500108
MV108	1	024510108



- ⊕ 850MQ
- ⊕ 860TX/A10
- 920MQ/A 8-9-10-11-12-13-14-15-16-17-18-19-20 mm
- 920MQ/PE 5-6-8-10-12 mm
- 920MQ/21 125 mm
- 920MQ/22 250 mm
- 920MQ/55A
- 943MQ 6-7-8-10 mm

3,1 kg

M110	1	024500110
MV110	1	024510110

M121

46



- 920BP 5L-6L-8L-10L-5XL-6XL-8XL mm
 - 920TX T20-T25-T27-T30-T40L-T45L-T50L-T55L-T60L-T70L
 - 920XZN 4-5-6-6L-8-8L-10-10L-12-12L-14-14L-16-18 mm
 - 920ES 7-9-10-11-12L-14L-16L-7XL-9XL-10XL-11XL-12XL-14XL-16XL mm
- 920/36A

12"

6,3 Kg



M121 1 024500121
MV121 1 024510121

M125

68



- 910AL 8-9-10-11-12-13-14-15-16-17-19-21-22 mm
 - 920PE 5-6-6L-7-8-8L-10-10L-12-12L mm
 - 920FTX E12-E14-E16-E18-E20-E22-E24
 - 920TX T20-T25-T27-T30-T30L-T40-T40L-T45-T50-T50L-T55-T60-T60L
 - 920XZN 5-6-6L-8-8L-10-10L-12L mm
 - 920AL 10-12-13-14-15-16-17-18-19-21-22-23-24-27-30-32 mm
- 1692/5

38" 12"

7,9 kg



M125 1 024500872
MV125 1 024510872

M126

26



- 928A 19-21-22-24-26-27-28-30-32-34-35-36-38-41-46 mm
- 928ME 14-17-19-22 mm
- 928/15 □ 3/4 - ■ 1/2
- 928/16 □ 3/4 - ■ 1
- 928/21 200 mm
- 928/22 380 mm
- 928/25 450 mm
- 928/42 450 mm
- 928/55

34"

12,4 kg



M126 1 024500126
MV126 1 024510126

M127

23



- 728 19-21-22-24-27-30-32-33-34-35-36-38-40-41-46
- 728FTX 20-22-24 mm
- 728/15 □ 3/4 - ■ 1/2
- 728/16 □ 3/4 - ■ 1
- 728/21 175 mm
- 728/22 250 mm
- 728/25

34"

12,5 kg



M127 1 024500127
MV127 1 024510127

M128

50

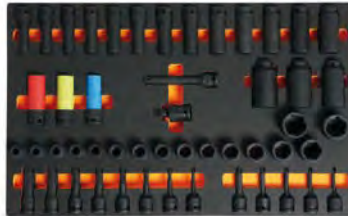

- 720 10-11-12-13-14-15-16-17-18-19-21-22-24-27-30-32 mm
- 720L 10-11-12-13-14-15-16-17-18-19-21-22-24-27-30-32 mm
- 720TX T30-T40-T45-T50-T55
- 720ME 5-6-8-10-12-14-17-19 mm
- 720LC 17-19-21 mm
- 720/21 125 mm
- 720/25

12"

8,9 kg



M128 1 024500128
MV128 1 024510128

M129

13



- 1032 180 mm
- 1034 170 mm
- 1036 175 mm
- 1038 175 mm
- 1048 250 mm
- 1052 240 mm
- 1082BM 160 mm
- 1098 220 mm
- 1112 250 mm
- 1128BM
- 1150BM 180 mm
- 1166BM 160 mm
- 1168BM 160 mm

3,4 Kg



M129 1 024500129
MV130 1 024510130

M133

3



- 1082G 160 mm
- 1150G 180 mm
- 1166G 160 mm

650 g



M133 1 024500133
MV133 1 024510133

M134

3



- 1082GBM 160 mm
- 1150GBM 180 mm
- 1166GBM 160 mm

750 g



M134 1 024500134
MV134 1 024510134

M135

3



- 1082MQ 160 mm
- 1150MQ 180 mm
- 1166MQ 160 mm

750 g



M135 1 024500135
MV135 1 024510135

M136

3



- 1084BM 160 mm
- 1150BM 180 mm
- 1166BM 160 mm

750 g



M136 1 024500136
MV131 1 024510131

M137



- 1084 160 mm
- 1150 180 mm
- 1166 160 mm

650 g



M137	1	024500137
MV132	1	024510132

M145



- 1032 180 mm
- 1034 170 mm
- 1036 175 mm
- 1038 175 mm

640 g



M145	1	024500145
MV145	1	024510145

M153



- 1048 250 mm
- 1052 240 mm

1 kg



M153	1	024500153
MV153	1	024510153

M161



- 1128MQ 250 mm
- 1048MQ 160 mm
- 1082MQ 180 mm
- 1150MQ 160 mm
- 1162MQ 160 mm
- 1164MQ 160 mm
- 1272MQ PH0x60 - PH1x80 - PH2x100 - PH3x150 mm
- 1274MQ 2,5x75 - 3x100 - 4x100 - 5,5x125 mm
- 1777MQ/U

3,0 kg



M161	1	024500161
MV161	1	024510161

M162



- 1241 5,5x100-6,5x125-8x150-10x200 mm
- 1242 PH1x100-PH2x100-PH3x150-PH4x200 mm

1,4 kg



M162	1	024500162
MV162	1	024510162

M166



- 860MIX/A31
- 1048 250 mm
- 1082BM 160 mm
- 1150BM 180 mm
- 1162BM 160 mm
- 1290 3x75-4x100-5,5x100-6,5x150-8x150 mm
- 1290N 6,5x30 mm
- 1292 4,5x80-6x100-8x150 mm
- 1292N 6x30 mm
- 1297TX T20-T25-T27-T30

2,9 kg



M166	1	024500879
MV165	1	024510874

M170



- 1290 2,5x50
- 3x75
- 3,5x100
- 4x125
- 5,5x100
- 5,5x150
- 6,5x150 mm

500 g



M170	1	024500170
MV170	1	024510170

M172



- 1292 PH0x60
- PH0x100
- PH1x80
- PH1x120
- PH2x100
- PH2x150 mm

450 g



M172	1	024500172
MV172	1	024510172

M174



- 1297TX T8-T10-T15-T20-T25-T30

450 g



M174	1	024500174
MV174	1	024510174

M180



- 1290 3x75
- 4x100
- 5,5x150
- 6,5x150 mm
- 1292 PH0x60
- PH1x80
- PH2x100 mm

500 g



M180	1	024500180
MV180	1	024510180



M195

25



- 1260 2,5x50-3x75-4x100-5,5x125-6,5x150-8x200 mm
- 1260N 4x30 mm
- ⊕ 1262 PH0x60-PH1x80-PH2x100-PH3x150 mm
- ⊕ 1262N PH1X30 mm
- ⊖ 1267TX T6-T7-T8-T9-T10-T15-T20-T25-T27-T30-T40-T45
- 1253 3,5x100 mm

2,3 kg



M195 1 024500195
MV195 1 024510195

M199

7



- 1260 2,5x50-3x75-3,5x100-4x125-5,5x100-5,5x150-6,5x150 mm

500 g



M199 1 024500199
MV199 1 024510199

M202

6



- ⊕ 1262 PH0x60-PH0x100-PH1x80-PH1x120-PH2x100-PH2x150 mm

450 g



M202 1 024500202
MV202 1 024510202

M204

6



- ⊖ 1267TX T8-T10-T15-T20-T25-T30

450 g



M204 1 024500204
MV204 1 024510204

M208

10



- 1260 3x75-3,5x100-4x125-5,5x150-6,5x150 mm
- ⊕ 1262 PH0x60-PH1x80-PH2x100 mm
- 1260N 4x30 mm
- ⊕ 1262N PH1x30 mm

750 g



M208 1 024500208
MV208 1 024510208

M209

10



- 1260N 4x30 mm
- 1264 2,5x60 - 3x100 - 4x125 - 5x150 - 6,5x150 mm
- ⊕ 1262 PH0x60 - PH1x80 - PH2x100 mm
- ⊕ 1262N PH1x30 mm

820 g



M209 1 024500209
MV208 1 024510208

M213

25

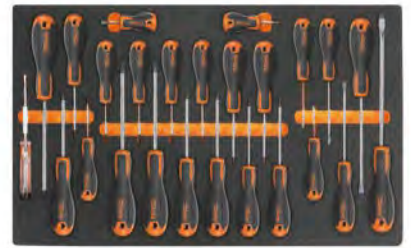

- 1201E 2,5x50-3x75-4x100-5,5x125-6,5x150-8x200 mm
- 1201EN 4x30 mm
- ⊕ 1202E PH0x60-PH1x80-PH2x100-PH3x150 mm
- ⊕ 1202EN PH1X30 mm
- ⊖ 1207E/TX T6-T7-T8-T9-T10-T15-T20-T25-T27-T30-T40-T45
- 1253 3,5x100 mm

1,8 Kg



M213 1 024500213
MV210 1 024510210

M214

7



- 1201E 2,5x50-3x75-3,5x100-4x125-5,5x100-5,5x150-6,5x150 mm

500 g



M214 1 024500214
MV211 1 024510211

M216

6



- ⊕ 1202E PH0x60-PH1x80-PH1x120-PH2x100-PH2x150-PH3x150 mm

450 g



M216 1 024500216
MV212 1 024510212

 **Beta**

 **Beta**

M217



1207E/TX T6-T7-T8-T9-T10-T15-T20

500 g



M217	1	024500217
MV215	1	024510215

M218



1201E 3x75
4x100
5,5x150
6,5x150 mm
1202E PH0x60
PH1x80
PH2x100 mm

500 g



M218	1	024500218
MV220	1	024510220

M219



1202E 3x60 - 4,5x80 - 6x100 mm
1204E 3x75 - 4x100 - 5x150 - 6,5x150 mm

590 g



M219	1	024500219
MV220	1	024510220

M223



1272MQ PH0x60 mm
1272MQ/F PH1x80 - PH2x100 mm
1274MQ/F 3,5x100 - 4,5x100 - 5,5x125 - 6,5x150 mm

620 g



M223	1	024500223
MV226	1	024510226

M224



1272MQ PH0x60
PH1x80
PH2x100 mm
1274MQ/F 3,5x100
4,5x100
5,5x125
6,5x150 mm

630 g



M224	1	024500224
MV226	1	024510226

M226



1274MQ 3x100
4x100
5,5x125
6,5x150 mm
1272MQ PH0x60
PH1x80
PH2x100 mm

500 g



M226	1	024500226
MV226	1	024510226

M227



944BX 6-7-8-10-13 mm

420 g



M227	1	024500227
MV227	1	024510227

M230



30 Ø 2-3-4 mm
31 Ø 2-3-4-5-6-8 mm
32 Ø 4 mm
34 150 mm
35 200-250 mm
36 125 mm
1370 500 g
1390 Ø 35 mm
1692 3 mm
1712TF
1719BMA/Q 200 mm
1719BMA/T 200 mm
1719BMA/P 200 mm
1719BMA/M 200 mm
1719BMA/R 200 mm
1737NX
1771 18 mm

3,2 Kg



M230	1	024500230
MV230	1	024510230

M231



31 2-3-4-5-6-8 mm
32 4 mm
34 125-150-175 mm
36 125 mm
1370 500-1000 g
1390 Ø 35 mm
1712TF 590 mm
1715 670 mm
1719BMA8/Q 200 mm
1719BMA8/T 200 mm
1719BMA8/P 200 mm
1719BMA8/M 200 mm
1719BMA8/R 200 mm
1737NX

4,7 kg



M231	1	024500877
MV231	1	024510877

Beta

Beta
Quality Tools

M234



35 100-200 mm
1370 300 g
1390 Ø 35 mm

1,3 kg



M234 1 024500234
MV232 1 024510232

M236



■ 1719BMA/Q 200 mm
▲ 1719BMA/T 200 mm
■ 1719BMA/P 200 mm
▶ 1719BMA/M 200 mm
● 1719BMA/R 200 mm

870 g



M236 1 024500236
MV236 1 024510236

M237



35 100-200 mm
1370T 300 mm
1390N Ø 35 mm

1,3 kg



M237 1 024500237
MV232 1 024510232

M240



31BM Ø 2-3-4-5-6-8 mm
32 Ø 4 mm

850 g



M240 1 024500240
MV240 1 024510240

M264



1491 Ø 65+110 mm
■ 1494 ■ 10 mm
○ 1494E ○ 8-9-10-11-12-14-17 mm
○ 1494Q ○ 8-9,5-12-13 mm
△ 1494T △ 9,5
○ 1494XZN ○ 16
1496C ■ 8x ■ 10 mm

2,1 kg



M264 1 024500264
MV264 1 024510264

M284



1128BMX
1130BMX
1719BMA...Q 200 mm
1719BMA...P 200 mm
1719BMA...M 200 mm
1719BMA...R 200 mm
1726BM 400 mm
1728BM (5)
1771BM 170 mm
1778V18 185 mm

2,4 Kg



M284 1 024500284
MV284 1 024510284

M285



1112 250 mm
1128BM
1726 440 mm
1728BM (5)
1753 200 cc

1,5 kg



M285 1 024500285
MV285 1 024510285

M289



1692 5 m
1725CR
1755 30 cc
1771

500 g



M289 1 024500289
MV289 1 024510289

M292



111 250 mm
1128BMX
1692/5 5 m
1771 170 mm

500 g



M292 1 024500292
MV292 1 024510292

M295



1650
1682 L=300 mm
1707
1708/20

450 g



M295 1 024500295
MV295 1 024510295

M305



1927B
○ 720 12-13-14-15-16-17
18-19-21-22
24-27 mm
720/21

4,2 kg



M305 1 024500305
MV305 1 024510305

M310

14



1927CD
 ○ 720 12-13-14-15-16-17
 18-19-21-22
 24-27 mm
 720/21

4,0 kg

12"



M310 1 024500310
 MV310 1 024510310

MC10

34



42NEW 6-7-8-9-10-11-12
 13-14-15-16-17
 18-19-21-22 mm
 96/SC9 1,5-2-2,5-3-4-5-6-8-10 mm
 1084BM 160 mm
 1150G 180 mm
 1166G 160 mm
 1201E 3,5x100-5,5x150-6,5x150 mm
 1202E PH0x60-PH1x80-PH2x100 mm

3,5 kg



MC10 1 027500011
 MCV10 1 027510010

MC12

26



42NEW 6-7-8-9-10-11-12-13-14-15-16-17-18-19-
 21-22 mm
 96/SC9 1,5-2-2,5-3-4-5-6-8-10 mm
 1692/5 5 m

2,2 kg



MC12 1 041500012
 MCV11 1 041510011



MC20

74



860MIX/A31
 895/1
 1048 250 mm
 1370 300 g
 32 Ø 4 mm
 36 Ø 4 mm
 900 4-4,5-5-5,5-6-7-8-9-10-11-12-13-14 mm
 900/21 150 mm
 900/25
 900BG/30C
 900/42
 900/55
 920A 10-11-12-13-14-15-16-17-18-19-21-22-
 24-27-30-32 mm
 920/25
 920AN/125 125 mm
 920/42
 920/55

6 kg

12"



MC20 1 027500020
 MCV20 1 027510020

MC21

24



920A 10-11-12-13-14-15-16-17-18-19-20-21-
 22-23-24-26-27-30-32 mm
 920/25
 920/42
 920/55
 920AN 125-250 mm

4,3 kg



MC21 1 041500021
 MCV21 1 041510021

MB12

30



42NEW 6-7-8-9-10-11-12-13-14-15-16-17-18-19-
 20-21-22-24-27-30-32 mm
 55 6x7-8x9-10x11
 12x13-14x15
 16x17-18x19
 20x22 mm
 1048 250 mm

5,4 kg



MB12 1 024504212
 MBV11 1 024524211

MB37

52



○ 920A 10-11-12-13-14-15-16-17-18-19-20-21-
 22-23-24-26-27-30-32 mm
 920/21 125 mm
 920/22 150 mm
 920/25
 920/42
 ⊕ 920/55
 111 250 mm
 1052 240 mm
 ⊕ 1084BM 160 mm
 ⊕ 1150BM 180 mm
 ⊕ 1166BM 160 mm
 ○ 1032 180 mm
 ○ 1034 170 mm
 ● 1036 175 mm
 ● 1038 175 mm
 ○ 900 4-4,5-5-5,5-6-7-8-9-10-11-12-13-14 mm
 900/20 50 mm
 900/21 150 mm
 900/25
 900BG/30
 ⊕ 900/55
 900/42

7,0 kg



MB37 1 024504237
 MBV34 1 024524234



MB38

80



- 96T 2-2,5-3-4-5-6-7-8 mm
- 851SR 230 mm
- 860LP 0,5x3 - 0,6x4,5 - 0,8x5,5 - 1x5,5 - 1,2x6,5 mm
- 860PE 2 - 2,5 - 3 - 4 - 5 - 6 - 8 - 10 mm
- ⊕ 860PH PH0 - PH1 - PH2 - PH3 - PH4
- ⊕ 860PZ PZ1 - PZ2 - PZ3 - PZ4
- ⊕ 860RTX T9-T10-T15-T20-T25-T27-T30-T40
- ⊕ 860TX T6-T7-T8-T9-T10-T15-T20-T25-T27-T30-T40
- 860/55 100 mm
- 882P
- 892/0
- 920A 10-11-12-13-14-15-16-17-18-19-20-21-22-23-24-26-27-30-32 mm
- 920/21 125 mm
- 920/22 255 mm
- 920/25
- 920/42
- ⊕ 920/55
- ⌘ 1084BM 160 mm
- ≡ 1150BM 180 mm
- 1166BM 160 mm

5,9 kg



MB38 1 024504238
MBV35 1 024524235

MB39

39



- 920A 10-11-12-13-14-15-16-17-18-19-20-21-22-23-24-26-27-30-32 mm
- 920/21 125 mm
- 920/22 255 mm
- 920/25
- 920/42
- ⊕ 920/55
- 920PE 5-6-8-10-12 mm
- 1032 180 mm
- 1034 170 mm
- 1036 175 mm
- 1038 175 mm
- 35 200 mm
- ⌘ 1084BM 160 mm
- ≡ 1150BM 180 mm
- 1166BM 160 mm
- 1370 500 g
- 1390 35 mm

7,2 kg



MB39 1 024504239
MBV36 1 024524236

MB44

34



- 1260 2,5x50-3x75-3,5x100-4x100-5,5x125-6,5x150-8x200 mm
- 1260N 4x30-6,5x30 mm
- ⊕ 1262 PH0x60-PH0x100-PH1x80-PH1x120-PH2x100-PH2x150-PH3x150 mm
- ⊕ 1262N PH1x30-PH2x30 mm
- 1253
- 96BPC/SC9
- 951 2,5-3-4-5-6-8 mm

2,8 kg



MB44 1 024504244
MBV44 1 024524244

MB45

29



- 1260 2,5x50-3x75-3,5x100-4x100-5,5x100-5x125-6,5x150 mm
- ⊕ 1262 PH0x60-PH0x100-PH1x80-PH1x120-PH2x100-PH2x150 mm
- ⊕ 1267TX T8-T10-T15-T20-T25-T30
- 1052 240 mm
- 96BPC/SC9

2,8 kg



MB45 1 024504245
MBV45 1 024524245

MB46

29



- 1260 3x75-4x100-5,5x125-6,5x150 mm
- ⊕ 1262 PH0x60-PH1x80-PH2x100 mm
- ⊕ 1267TX T8-T10-T15-T20-T25-T30
- 96BPC/SC9
- 96T 2-2,5-3-4-5-6
- 1052 240 mm

2,8 kg



MB46 1 024504246
MBV46 1 024524246

MB47

48



- 1260 3x75-4x100-5,5x125-6,5x150 mm
- ⊕ 1262 PH0x60-PH1x80-PH2x100 mm
- 1260N 4x30 mm
- ⊕ 1262N PH1x30 mm
- 96T 2,5-3-4-5-6-8 mm
- 96BPC/SC9
- 920A 10-11-12-13-14-15-16-17-18-19-20-21-22-23-24-26-27-30-32 mm
- 920/21 125 mm
- 920/22 250 mm
- 920/25
- 920/42
- ⊕ 920/55

5,6 kg



MB47 1 024504247
MBV47 1 024524247

MB56

15



- 1719BMA/Q 200 mm
- ▲ 1719BMA/T 200 mm
- 1719BMA/P 200 mm
- ▶ 1719BMA/M 200 mm
- 1719BMA/R 200 mm
- 1032 180 mm
- 1034 170 mm
- 1036 175 mm
- 1038 175 mm
- 1370T 300 g
- 1390N Ø 35 mm
- 35 200 mm
- 1692 5 mt
- 1725CR 260 mm
- 1771 18 mm

3,7 kg



MB56 1 024504256
MBV56 1 024524256



MB59

15



1719BMA...Q	200 mm
1719BMA...T	200 mm
1719BMA...P	200 mm
1719BMA...M	200 mm
1719BMA...R	200 mm
31	Ø 4-6 mm
32	Ø 4 mm
35	125-200 mm
1370	300 g
1390	Ø 35 mm
1692	5 mt
1725	420 mm
1833XS/2	

3,4 kg



MB59	1	024504259
MBV57	1	024524257

MB58

17



31	Ø 2-3-4-5-6 mm
32	Ø 4 mm
35	200 mm
1112	250 mm
1128BMX	
1370	500 g
1390	Ø 45 mm
1719BMA...Q	200 mm
1719BMA...T	200 mm
1719BMA...P	200 mm
1719BMA...M	200 mm
1719BMA...R	200 mm
1726	440 mm

4,5 kg



MB58	1	024504258
MBV55	1	024524255

MB65

16



1719BMA...Q	200 mm
1719BMA...P	200 mm
1719BMA...T	200 mm
1719BMA...M	200 mm
1719BMA...R	200 mm
35	200 mm
1032	180 mm
1034	170 mm
1036	175 mm
1038	175 mm
1052	240 mm
1084BM	160 mm
1150BM	180 mm
1166BM	160 mm
1370	500 g
1390	Ø 35 mm

4,8 kg



MB65	1	024504265
MBV61	1	024524261

MB63

60



96BPC/SC9	
1250	4x125 mm
1251	PH1x150 mm
1253	
943MQ	5,5-6-7-8-10-13 mm
1272MQ	PH0x60-PH1x80-PH2x100-PH3x150 mm
1274MQ	2,5x75-3x100-4x100-5,5x125-6,5x150-8x175 mm
860LP	0,5x3 - 0,6x4 - 0,8x5,5 1,0x5,5 - 1,2x6,5 mm
860PE	2 - 2,5 - 3 - 4 - 5 - 6 8 - 10 mm
860PH	PH0 - PH1 - PH2 - PH3 - PH4
860PZ	PZ1 - PZ2 - PZ3 - PZ4
860RTX	T9 - T10 - T15 - T20 T25 - T27 - T30 - T40
882MSR/50	Ø 1/4 ● 1/4
850MQ	

3,2 kg



MB63	1	024504263
MBV63	1	024524263

MB64

20



55	6x7-8x9-10x11 12x13-14x15 16x17-18x19 20x22 mm
1048MQ	250 mm
1082MQ	140 mm
1128BSX	
1132MQ	230 mm
1142MQ	160 mm
1150MQ	180 mm
1166MQ	160 mm
1168MQ	160 mm
110MQ	250 mm
1777MQ	
993MQ	
1602	

4,1 kg



MB64	1	024504264
MBV62	1	024524262



MM11

30



42NEW 6-7-8-9-10-11-12-13-14-15-16-17-18-19-
20-21-22-24-27-30-32 mm
 ○96BPC/SC9 1,5-2-2,5-3-4-5-6-8-10 mm

4,5 kg



MM11 1 024580011
 MMV10 1 024590010

MM61

17



○96T 2-2,5-3-4-5-6-7-8 mm
 1390 Ø 35
 1370 300 g
 35 100-200 mm
 1719BMA8/S5 200 mm

2,9 kg



MM61 1 024580061
 MMV61 1 024590061



MM105

107



895/1 □1/4 □1/4
 895/3 □1/4 □3/8
 895/6 □5/16 □1/2
 ○900 4-4,5-5-5,5-6-7-8-9-10-11-12-13-14 mm
 ○900L 5-6-7-8-9-10-11-12-13 mm
 ○900ME 3-4-5-6-7 mm
 ●900LP 0,8x4-1x5,5-1,2x6,5-1,2x8
 ⊕900PH PH1-PH2-PH3-PH4
 ⊕900TX T10-T15-T20-T25-T27-T30-T40
 900/16
 900/... 50-100-150 mm
 900/25
 900BG/30 176 mm
 900/42 115 mm
 ⊕900/55 125 mm
 ○910A 6-7-8-9-10-11-12-13-14-15-16-17-18-19-
20-21-22 mm
 910/15 □3/8 ■1/4
 910/16 □3/8 ■1/2
 910/21 125 mm
 910/22 250 mm
 910/25
 910/42 210 mm
 ⊕910/55 200 mm
 ○920A 8-10-11-12-13-14-15-16-17-18-19-20-21-
22-23-24-26-27-28-30-32 mm
 920/15 □1/2 ■3/8
 920/25
 920AN 125-250 mm
 920/42 305 mm
 ⊕920/55 275 mm
 ○956E 16 mm (5/8")-17,8 (11/16")-20,8 (13/16")

7,2 kg

14" 3/8" 12"

MM105 1 024580105
 MMV105 1 024590105

MM140

52



⊕97TTX T10-T15-T20-T25-T30
 ⊕1084BM 160 mm
 ⊕1150BM 180 mm
 ●1166BM 160 mm
 ○1032 180 mm
 ○1034 170 mm
 ●1036 175 mm
 ●1038 175 mm
 1048 250 mm
 1052 240 mm
 1256/C36-2

2,2 kg



MM140 1 024580141
 MMV140 1 024590140

MM210

25



●1201E 2,5x50-3x75-4x100-5,5x125-6,5x150-
8x200 mm
 ●1201EN 4x30 mm
 ⊕1202E PH0x60-PH1x80-PH2x100-PH3x150 mm
 ⊕1202EN PH1X30 mm
 ⊕1207E/TX T6-T7-T8-T9-T10-T15-T20-T25-T27-
T30-T40-T45
 ●1253

2,1 kg



MM210 1 024580211
 MMV210 1 024590210



VPM0
soft thermoformed tray with tote tray

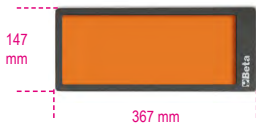

VPM0 1 088870350

VPM3
soft thermoformed tray with 4 tote trays

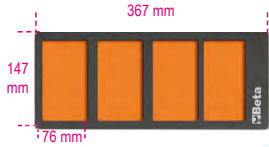

VPM3 1 088870353

VPM7
soft thermoformed tray with 3 tote trays

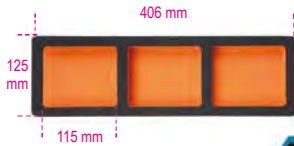

VPM7 1 088870356

VPM8
soft thermoformed tray with tote tray



VPM8 1 088870357

VPM9
soft thermoformed tray with tote tray



VPM9 1 088870358

VPM7-C

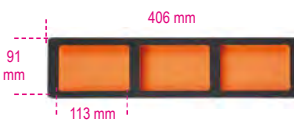

VPM7-C 1 088870360

Hard thermoformed trays T-series



Assortment of tools in thermoformed trays, designed for all roller cabs and all trolleys.

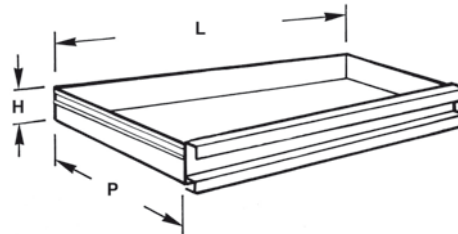

H mm 70
LxP mm 588x367

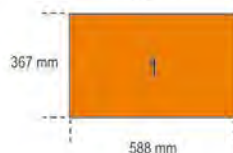
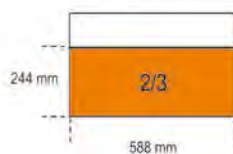
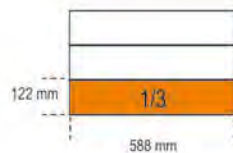
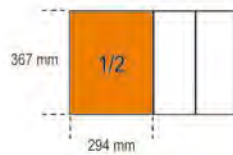
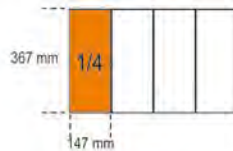

T01



42NEW 6-7-8-10-11-12-13
14-16-17-18-19-21
22-24-27-30 mm

2,7 kg



T01 1 024240001
TV10 1 024000400

T05



42NEW 6-7-8-9-10-11-12
13-14-15-16-17
18-19-20-21 mm

1,5 kg



T05 1 024240005
TV15 1 024000445

T06



42NEW 22-24-27-30-32 mm

2,1 kg



T06 1 024240006
TV16 1 024000446

T13



42SLIM 8-10-11-12
13-14-15-16-17
18-19 mm

1,5 kg



T13 1 024240013
TV13 1 024249913

T18



42MP 6-7-8-9-10-11-12
13-14-15-16-17
18-19-20-21 mm

1,5 kg



T18 1 024240018
TV15 1 024000445

T19



42MP 22-24-27-30-32 mm

2,1 kg



T19 1 024240019
TV16 1 024000446

T22



42AS 5/16-3/8-7/16-1/2
9/16-5/8-11/16-3/4
3/32-1/8-5/32-3/16
1/4-5/16-3/8
○96AS/BG7

1 kg



T22 1 024240022
TV20 1 024000488

T23



42INOX 8-10-11-12-13-14-15-
17-19 mm
○96BPINOX 2,5-3-4-5-6-8-10 mm



1 kg



T23 1 024240023
TV23 1 024249906

T31



31 Ø 2-3-4-5-6 mm
32 Ø 4 mm
55 6x7-8x9-10x11
12x13-14x15
16x17-18x19
20x22-21x23
24x26-27x29
30x32 mm
○96N/SC9 1,5+10 mm

3 kg



T31 1 024240031
TV30 1 024000401

T33



55 6x7-8x9-10x11
12x13-14x15
16x17-18x19
20x22 mm
○96/SC9 1,5+10 mm

1 kg



T33 1 024240033
TV20 1 024000488

T34



55MP 6x7-8x9-10x11
12x13-14x15
16x17-18x19
20x22 mm
○96/SC9 1,5+10 mm

1 kg



T34 1 024240034
TV20 1 024000488

T40



90 6x7-8x9-10x11
12x13-14x15
16x17-18x19 mm

810 g



T40 1 024240040
TV40 1 024000456

T41



90 20x22-21x23
24x26-25x28
27x29 mm

1,5 kg



T41 1 024240041
TV41 1 024000457

T45



142 8-9-10-11-12
13-14-15-16
17-18-19 mm

1,3 kg



T45 1 024240045
TV45 1 024000498

T46



142SN 8-9-10-11-12
13-14-15-16
17-18-19 mm

1,5 kg



T46 1 024240046
TV46 1 024000499

T48



○96BPC/SC9 1,5+10 mm
142C 8-9-10-11-12
13-14-15-16
17-18-19 mm

1,4 kg



T48 1 024240048
TV47 1 024000763

T50



○96T

2-2,5-3-3,5-4-4,5
5-6-7-8-10 mm

1,3 kg



T50	1	024240050
TV50	1	024000764

T52



○96T

2-2,5-3-4-5-6 mm

350 g



T52	1	024240052
TV52	1	024000765

T53



○96TBP

2,5-3-4-5-6 mm

300 g



T53	1	024240053
TV52	1	024000765

T55



○97TTX

T10-T15-T20
T25-T27-T30

330 g



T55	1	024240055
TV55	1	024000766

T56



○96BP

2-3-4-5-6-8-10 mm

○97TX

T20-T25-T30-T40-
T45-T50-T55

300 g



T56	1	024240056
TV56	1	024249901

T57



○96TINOX

2,5-3-4-5-6 mm



350 g



T57	1	024240057
TV57	1	024249907

T59



111

250 mm

920/40

■ 1/2

○951

2,5-3-4-5-6-8 mm

○953

4-5-6-8 mm

1370

300 - 500 g

4,7 kg



T59	1	024240059
TV60	1	024000420

T63



○952

7-8-10-12-13-14-17-19 mm

3,8 kg



T63	1	024240063
TV63	1	024000471

T64



○952FTX

E10-E12-E14

○953TX

T25-T27-T30-T40-T45

3,8 kg



T64	1	024240064
TV63	1	024000471

T65



○953

3-3,5-4-5-6-7-8-10 mm

2,8 kg



T65	1	024240065
TV63	1	024000471

T68



○951

2,5-3-4-5-6-8 mm

590 g



T68	1	024240068
TV68	1	024000470

T73



○930

6x7-8x9-10x11-12x13-
14x15-16x17-18x19-
20x22 mm

940/1

940/2

1,3 kg



T73	1	024240073
TV73	1	024000418

T75



○ 933 7-8-9-10-11-12-13
14-15-16-17-18-19
21-22-24 mm

4,2 kg



T75 1 024240075
TV75 1 024000422

T76



○ 932 7-8-9-10-11-12-13
14-15-16-17-18-19
21-22-24 mm

4,2 kg



T76 1 024240076
TV75 1 024000422

T77



○ 933 6-7-8-10-11-12-13
14-17-19 mm

1,4 kg



T77 1 024240077
TV77 1 024000474

T79



80 8x9-10x11-12x13
14x15-16x17
18x19 mm

1,3 kg



T79 1 024240079
TV79 1 024000490

T80



○ 920A 10-11-12-13-14
15-16-17-18-19
20-21-22-23-24
26-27-30-32 mm
○ 920ME
920/21 125 mm
920/22 255 mm
920/25
920/42 305 mm
⊗ 920/55

4,1 kg

12"



T80 1 024240080
TV80 1 024000403

T81



○ 920B 10-11-12-13-14
15-16-17-18-19
20-21-22-23-24
26-27-30-32 mm
○ 920ME
920/21 125 mm
920/22 255 mm
920/25
920/42 305 mm
⊗ 920/55

4,1 kg

12"



T81 1 024240081
TV80 1 024000403

T82



○ 920A 10-11-12-13-14
15-16-17-18-19
20-21-22-23-24
26-27-30-32 mm
○ 920ME
920AN/125 125 mm
920AN/250 250 mm
920/25
920/42 305 mm
⊗ 920/55

4,1 kg

12"



T82 1 024240082
TV80 1 024000403

T83



○ 920A 10-11-12-13-14
15-16-17-18-19
20-21-22-23-24
26-27-30-32 mm
920/21 125 mm
920/22 255 mm
920/25
920/42 305 mm
⊗ 920/55

3,6 kg

12"



T83 1 024240083
TV83 1 024000402

T85



● 861LP 0,5x3 - 0,6x4,5 - 0,8x5,5 - 1x5,5 -
1,2x6,5 - 1,2x8 - 1,6x8 mm
○ 861PE 2 - 2,5 - 3 - 4 - 5 - 6 - 8 - 10 mm
⊕ 861PH PH0 - PH1 - PH2 - PH3
⊕ 861PZ PZ1 - PZ2 - PZ3
⊗ 861TX T6-T7-T8-T9-T10-T15-T20-T25-
T27-T30-T40
⊗ 861RTX T9-T10-T15-T20-T25-T27-
T30-T40
⊗ 861TRW 1-2-3-4-5-6 mm
⊗ 861TQS 0-1-2-3-4-5-6-8 mm
⊗ 861SP 4-6-8-10-12 mm
851SR 230 mm
○ 900 4-4,5-5-5,5-6-7-8-9
10-11-12-13-14 mm
900/21 150 mm
900/25 41 mm
900BG/30 176 mm
900/42 115 mm
⊗ 900/55 125 mm
194 1/4x5/16

1,0 kg

14"



T85 1 024240085
TV85 1 024000747

T91



○ 900 4-4,5-5-5,5-6
7-8-9-10-11
12-13-14 mm
○ 900ME 2,5-3-4-5-6-8 mm
900/20 50 mm
900/21 150 mm
900/25
900BG/30
900/42 115 mm
⊗ 900/55

560 g

14"



T91 1 024240091
TV90 1 024000447

T92



○ 910A 6-7-8-9-10-11-12-13
14-15-16-17-18-19
20-21-22 mm
910/21 125 mm
910/22 250 mm
910/25
910/42 210 mm
⊗ 910/55

1,5 kg

38"



T92 1 024240092
TV92 1 024000458

T99



○ 920INOX-A 10-12-13-14-15-16-17
18-19-21-22-24-27
30-32mm

⊗ 920/55INOX



2,7 kg

12"



T99	1	024240099
TV99	1	024249908

T100



○ 920A 10-12-13-14-15
16-17-18-19-21
22-24 mm

920/21 125 mm

920/25 305 mm

920/42 305 mm

⊗ 920/55

2,1 kg

12"



T100	1	024240100
TV100	1	024000495

T101



○ 920B 10-12-13-14-15
16-17-18-19-21
22-24 mm

920/21 125 mm

920/25 305 mm

920/42 305 mm

⊗ 920/55

2,1 kg

12"



T101	1	024240101
TV100	1	024000495

T102



○ 920AS 3/8-7/16-1/2
9/16-5/8-11/16
3/4-13/16-7/8
15/16-1-1.1/16

920/21 125 mm

920/25 305 mm

920/42 305 mm

⊗ 920/55

2,1 kg

12"



T102	1	024240102
TV100	1	024000495

T103



○ 900L 6-7-8-9-10-11-12 mm

○ 920AL 13-14-16-17-18-19
21-22-24-27 mm

1,1 kg

14" 12"



T103	1	024240103
TV103	1	024000748

T105



○ 928A 22-24-27-30-32-34
36-38-41-46-50 mm

4,9 kg

3/4"



T105	1	024240105
TV105	1	024000484

T106



928/21 200 mm

928/22 380 mm

928/42 450 mm

928/55

4,5 kg

3/4"



T106	1	024240106
TV106	1	024000485

T110



○ 720 10-11-12-13-14
16-17-18-19-21
22-23-24 mm

720/21 125 mm

1,8 kg

12"



T110	1	024240110
TV110	1	024000477

T112



⊗ 861TX ● 1/4-T6+T15

⊗ 866TX ● 5/16-T20+T55

895/1 ○ 1/4x□1/4

895/6 ○ 5/16x□1/2

⊗ 900FTX □ 1/4-E4+E10

⊗ 920FTX □ 1/2-E12+E24

⊗ 920TX □ 1/2-T55L-T60-T70L

1,3 kg

14" 12"



T112	1	024240112
TV112	1	024000480

T113



○ 920PE 5L-6L-7L-8L-10L

⊗ 920TX T40L-T45L
T55L-T70L

○ 920XZN M6L-M8L-M12L

1,5 kg

12"



T113	1	024240113
TV113	1	024000489

T121



666N/20 40 - 200 Nm

1,4 kg

12"



T121	1	024240121
TV121	1	024000767

T137



⊗ 1084BM 160 mm

⊗ 1150BM 180 mm

⊗ 1166BM 160 mm

750 g



T137	1	024240137
TV130	1	024000451

T135



- ◄ 1082MQ 160 mm
- ▬ 1150MQ 180 mm
- 1166MQ 160 mm

⚡ 1000 V

📦 750 g



T135 1 024240135
TV135 1 024000762

T136



- 1048MQ 250 mm
- 1777MQ/U

📦 700 g



T136 1 024240136
TV136 1 024000438

T138



- ◄ 1084 160 mm
- ▬ 1150 180 mm
- 1166 160 mm

📦 650 g



T138 1 024240138
TV130 1 024000451

T140



- 1032 140x0,9 - 180 mm
- 1034 170 mm
- 1036 140x1,3 - 175 mm
- 1038 175 mm
- ◄ 1084 160 mm
- 1128BM

📦 1,1 kg



T140 1 024240140
TV140 1 024000405

T144



- 1048 250 mm
- 1052 240 mm
- 1112 250 mm
- ▬ 1150 180 mm

📦 1,8 kg



T144 1 024240144
TV143 1 024000409

T145



- 1032 180 mm
- 1034 170 mm
- 1036 175 mm
- 1038 175 mm

📦 640 g



T145 1 024240145
TV145 1 024000448

T146



- 1032 140x0,9 mm
- 1032 225 mm
- 1036 140x1,3 mm
- 1036 225 mm

📦 700 g



T146 1 024240146
TV146 1 024000449

T151



- 1047 240 mm
- 1057A 240 mm

📦 1,3 kg



T151 1 024240151
TV150 1 024000462

T153



- 1048 250 mm
- 1052 240 mm

📦 1,1 kg



T153 1 024240153
TV150 1 024000462

T156



- ◄ 1082 160 mm
- ▬ 1150 180 mm
- 1048 250 mm

📦 1 kg



T156 1 024240156
TV148 1 024000500

T157



- ◄ 1082BM 160 mm
- ▬ 1150BM 180 mm
- 1048BM 250 mm

📦 1,1 kg



T157 1 024240157
TV148 1 024000500

T160



Betamax
BETAMAX GROUP

- 1290 3x75
- 3x100
- 4x100
- 4x150
- 5,5x100
- 5,5x150
- 6,5x150
- 8x150
- 10x200 mm
- 1290N 4x30
- 6,5x30 mm

📦 1,3 kg



T160 1 024240160
TV160 1 024000706

T161

Betamax



- 1292 PH0x60
PH0x100
PH1x80
PH1x120
PH2x100
PH2x150
PH3x150 mm
- 1292N PH1x30
PH2x30 mm

1 kg



T161	1	024240161
TV161	1	024000707

T164



- 952 8-10-13-17-19 mm
- 959 16 mm (5/8") - 20,8 mm (13/16")
- 1260 3x75-4x100-5,5x100
6,5x150-10x200 mm
- 1262 PH0x60-PH1x80
PH2x100-PH3x150 mm

5 kg



T164	1	024240164
TV61	1	024000721

T167



- 1260 3x75
3x100
4x100
4x150
5,5x100
5,5x150
6,5x150
8x150
10x200 mm
- 1260N 4x30
6,5x30 mm

1,3 kg



T167	1	024240167
TV160	1	024000706

T168



- 1262 PH0x60
PH0x100
PH1x80
PH1x120
PH2x100
PH2x150
PH3x150 mm
- 1262N PH1x30
PH2x30 mm

1 kg



T168	1	024240168
TV161	1	024000707

T170

Betamax



- 1290 2,5x50
3x75
3,5x100
4x125
5,5x100
5,5x150
6,5x150 mm

450 g



T170	1	024240170
TV170	1	024000741

T171

Betamax



- 1290 8x150
8x200
10x200 mm
- 1290N 4x30
6,5x30 mm

750 g



T171	1	024240171
TV171	1	024000742

T172

Betamax



- 1292 PH0x60
PH0x100
PH1x80
PH1x120
PH2x100
PH2x150 mm

450 g



T172	1	024240172
TV172	1	024000743

T173

Betamax



- 1292 PH3x150
PH4x200 mm
- 1292N PH1x30
PH2x30 mm

560 g



T173	1	024240173
TV173	1	024000744

T175

Betamax



- 1297TX T6-T7-T8-T9
T10-T15-T20

410 g



T175	1	024240175
TV175	1	024000760

T176

Betamax



- 1297TX T25-T27-T30
T40-T45

640 g



T176	1	024240176
TV176	1	024000761

T177

Betamax



- 1298RTX T9-T10-T15
T20-T25-T27
T30-T40

680 g



T177	1	024240177
TV177	1	024000759

T180

Betamax



- 1290 3x75
4x100
5.5x150
6.5x150 mm
- ⊕ 1292 PH0x60
PH1x80
PH2x100 mm

480 g



T180 1 024240180
TV180 1 024000701

T183

Betamax



- ⊕ 1292L PH1x400-PH2x400 mm
- 1294L 3x300-4x400-5x400 mm

580 g



T183 1 024240183
TV183 1 024000497

T198



- 1260 3x75
4x100
5.5x150
6.5x150 mm
- ⊕ 1269PZ PZ0 - PZ1 - PZ2

490 g



T198 1 024240198
TV180 1 024000701

T199



- 1260 2.5x50
3x75
3.5x100
4x125
5.5x100
5.5x150
6.5x150 mm

490 g



T199 1 024240199
TV170 1 024000741

T201



- 1260 8x200
10x150
10x200 mm
- 1260N 4x30
6.5x30 mm

680 g



T201 1 024240201
TV171 1 024000742

T202



- ⊕ 1262 PH0x60
PH0x100
PH1x80
PH1x120
PH2x100
PH2x150 mm

490 g



T202 1 024240202
TV172 1 024000743

T204



- ⊕ 1262 PH3x150
PH4x200 mm
- ⊕ 1262N PH1x30
PH2x30 mm

610 g



T204 1 024240204
TV173 1 024000744

T205



- ⊕ 1267TX T6-T7-T8-T9
T10-T15-T20

460 g



T205 1 024240205
TV175 1 024000760

T206



- ⊕ 1267TX T25-T27-T30
T40-T45

710 g



T206 1 024240206
TV176 1 024000761

T207



- ⊕ 1268RTX T9-T10-T15
T20-T25-T27-T30

760 g



T207 1 024240207
TV207 1 024000758

T208



- 1260 3x75
4x100
5.5x150
6.5x150 mm
- ⊕ 1262 PH0x60
PH1x80
PH2x100 mm

530 g



T208 1 024240208
TV180 1 024000701

T209



- ⊕ 1262L PH1x400-PH2x400 mm
- 1264L 3x300-4x400-5x400 mm

580 g



T209 1 024240209
TV183 1 024000497

T211



- 1201E 2,5x50
3x75
3,5x100
4x125
5,5x100
5,5x150
6,5x150 mm

490 g



T211	1	024240211
TV170	1	024000741

T213



- ⊕ 1202E PH0x60
PH1x80
PH1x120
PH2x100
PH2x150
PH3x150 mm

490 g



T213	1	024240213
TV212	1	024000440

T216



- ⊙ 1207E/TX T6-T7-T8-T9
T10-T15-T20

410 g



T216	1	024240216
TV175	1	024000760

T221



- 1201E 3x75
4x100
5,5x150
6,5x150 mm
- ⊕ 1202E PH0x60
PH1x80
PH2x100 mm

530 g



T221	1	024240221
TV180	1	024000701

T226



- 1274MQ 3x100
4x100
5,5x125
6,5x150 mm
- ⊕ 1272MQ PH0x60
PH1x80
PH2x100 mm

⚡ 1000 V

460 g



T226	1	024240226
TV180	1	024000701

T227



- 944BX 5-6-7-8-10-13 mm

490 g



T227	1	024240227
TV227	1	024000705

T228



- 1290INOX 3x75 - 4x100 -
5,5x150 - 6,5x150 mm
- ⊕ 1292INOX PH0x60 - PH1x80 -
PH2x100 mm



480 g



T228	1	024240228
TV180	1	024000701

T231



- 1370 400 g
- 1390 Ø 35 mm
- ▲ 1719BMA/T 200 mm
- 1719BMA/P 200 mm
- ▷ 1719BMA/M 200 mm

1,7 kg



T231	1	024240231
TV230	1	024000411

T233



- 35 100-200 mm
- 1370F 32 mm
- 1390 Ø 35 mm

1,3 kg



T233	1	024240233
TV232	1	024000452

T234



- 35 100-200 mm
- 1370 300 g
- 1390 Ø 35 mm

1,3 kg



T234	1	024240234
TV232	1	024000452

T236



- 1719BMA/Q 200 mm
- ▲ 1719BMA/T 200 mm
- 1719BMA/P 200 mm
- ▷ 1719BMA/M 200 mm
- 1719BMA/R 200 mm

870 g



T236	1	024240236
TV235	1	024000453

T239



- 31BM Ø 2-3-4-5-6-8 mm
- 32 Ø 4 mm

850 g



T239	1	024240239
TV239	1	024000439

T241



1500N/1
1500N/3
1516/1

4,2 kg

T241 1 024240241
TV241 1 024000414

T250

Automotive



34 150 mm
83/S3 11x13-14x17
19x22 mm
1458 175 mm
1491
1603
1708/13 0,05+1 mm

1430 g

T250 1 024240250
TV250 1 024000408

T256

Automotive



○ 956E 16 mm (5/8) - 20,8 mm (13/16)
○ 956L 16 mm (5/8) - 20,8 mm (13/16)
959 16 mm (5/8) - 20,8 mm (13/16)
■ 1164 200 mm
1708/20 0,05+1 mm

3,2 kg

T256 1 024240256
TV256 1 024000467

Beta

Quality Tools

T259



○ 96BP 2,5-3-4-5
6-8-10 mm
○ 96N 12 mm
● 860MIX/A31
○
○
○
○
○
895/1

950 g

T259 1 024240259
TV263 1 024000492

T264



1491 Ø 65+110 mm
■ 1494 ■ 10 mm
○ 1494E ○ 8-9-10-11-12-14-17 mm
○ 1494Q ○ 8-9,5-12-13 mm
△ 1494T △ 9,5
○ 1494XZN ○ 16
1496C ■ 8x ■ 10 mm

2,1 kg

T264 1 024240264
TV264 1 024000466

T270



430 M3 - 4 - 5 - 6 - 7 - 8 - 9
10 - 12 - 14 - 16 - 18 - 20
433 M6x0,75 - M8x1 - M10x1,25
M12x1,5 - M14x1,5
M16x1,5 - M18x1,5
440 M3 - 4 - 5 - 6 - 7 - 8 - 9
440A M10 - 12 - 14 - 16 - 18 - 20
441 M6x0,75 - M8x1,0
441A M10x1,25 - M12x1,5
M14x1,5 - M16x1,5
M18x1,5

4,3 kg

T270 1 024240270
TV270 1 024000481

T273



435/1,5 M3+M12
435/3 M5+M21
436/1 □ 2,0+5,0 mm
(M3+M8)
436/2 □ 4,6+8 mm
(M5+M12)
444/1 Ø 25,4 mm
444/2 Ø 38,1 mm
1707 W 62+4x1"

2,1 kg

T273 1 024240273
TV272 1 024000482

T281



1741B 250 mm
1741RV2,9K 2,9x6 mm (100)
1741RV3,2K 3,2x8 mm (100)
1741RV3,8K 3,8x10 mm (100)
1741RV4K 4x12 mm (100)

1,4 kg

T281 1 024240281
TV280 1 024000478

T285



1112 250 mm
1128BM -
1726 400 mm
1728BM (5)
1753 200 cc

1,5 kg

T285 1 024240285
TV285 1 024000487

Beta

Beta

T284



1128BMX	
1130BMX	
1719BMA...Q	200 mm
1719BMA...T	200 mm
1719BMA...P	200 mm
1719BMA...M	200 mm
1719BMA...R	200 mm
1726BM	400 mm
1728BM	
1771BM	170 mm
1778V18	185 mm

3,3 kg



T284	1	024240284
TV286	1	024249904

T289



1692	5 m
1725CR	-
1755	30 cc
1771	-

500 g



T289	1	024240289
TV290	1	024000455

T291



1479RB/1	
1479RB/2	
1479RB/3	

600 g



T291	1	024240291
TV291	1	024000472

T297



1651DGT	
1682	
1691BM	

490 g



T297	1	024240297
TV296	1	024000749

VP1 - VP2

thermoformed trays for small items, made from plastic for all roller cabs C22, C23, C23C

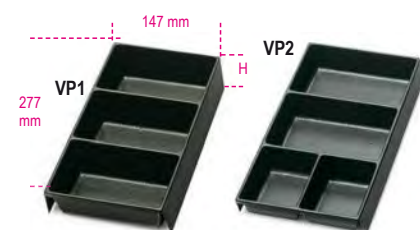

	H mm		
VP1	50	1	088880351
VP2	35	1	088880352

VP3 - VP4

thermoformed trays for small items, made from plastic for all roller cabs and all trolleys

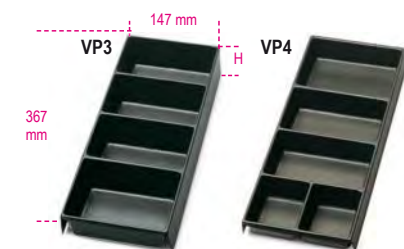

	H mm		
VP3	50	1	088880353
VP4	35	1	088880354

VP5

thermoformed tray



VP5	1	088880355
-----	---	-----------

VP6

thermoformed tray

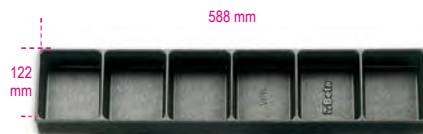

VP6	1	088880359
-----	---	-----------

VP-3SC

thermoformed tool trays, made from plastic, for mobile roller cab C38 +C04TSS-7

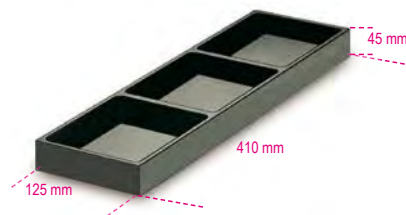

	H mm		
VP-3SC	45	1	088880356

VP-LS

thermoformed tool trays, made from plastic, for mobile roller cab C38 +C04TSS-7



	H mm		
VP-LS	45	1	088880357

VP-LD

thermoformed tool trays, made from plastic, for mobile roller cab C38



	H mm		
VP-LD	45	1	088880358

8889P1

parallel partitions for item C22S e C27S

drawer 588x257 mm



	h		
8889P1/5	50 mm	1	088890005
8889P1/7	70 mm	1	088890007

8889C1

crossed partitions for item C22S and C27S

for drawer 588x257 mm

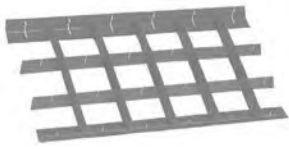

	h		
8889C1/5	50 mm	1	088890015
8889C1/7	70 mm	1	088890017

8889P2

parallel partitions for standard drawer 588x367 mm



	h		
8889P2/7	70 mm	1	088890107

8889C2

crossed partitions for standard drawer 588x367 mm

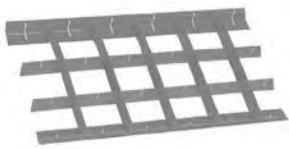

	h		
8889C2	70 mm	1	088890117

8889P3

parallel partitions for item C24SA-XL

for drawer 882x367 mm



	h		
8889P3	70 mm	1	088890207

8889C3

crossed partitions for C24SA-XL

for drawer 882x367 mm



	h		
8889C3	70 mm	1	088890217

8889P4

parallel partitions for item C41

for drawer 418x205 mm



	h		
8889P4	70 mm	1	088890307

8889I4

crossed partition for item trolley C41

for drawer 418x205 mm



	h		
8889C4	70 mm	1	088890317

8889PS

parallel partitions for item C38 +C04TSS-7

left side drawer 570x410 mm



	h		
8889PS/7	70 mm	1	088890407

8889CS

crossed partitions for item C38 +C04TSS-7

left side drawer 570x410 mm

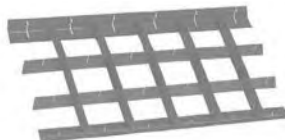

	h		
8889CS/7	70 mm	1	088890417

8889PD

parallel partitions for item C38 +C04TSS-7

right side drawer 313x410 mm



	h		
8889PD/7	70 mm	1	088890427

8889CD

crossed partitions for item C38 +C04TSS-7

right side drawer 313x410 mm



	h		
8889CD/7	70 mm	1	088890437

8889C6

crossed partitions for item C35

for drawer 600x447 mm

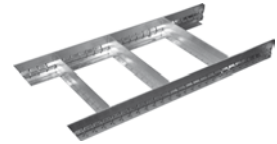

	h		
8889C6/7,5	75 mm	1	088890475
8889C6/10	100 mm	1	088890480
8889C6/15	150 mm	1	088890485
8889C6/20	200 mm	1	088890490

SB

socket rails



	L		
SB1	210 mm	10	088880201
SB2	280 mm	10	088880202
SB3	360 mm	10	088880203

MB

socket clips for rails SB



MB0	1/4	50	088880210
MB1	3/8	50	088880211
MB2	1/2	50	088880212

KIT/GPS

kit of 40-mm GPS hooks with screws VE1

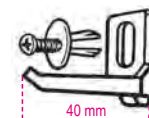

KIT/GPS		50	088880119

VE1

expansion bolts



VE1		20	088880120

GM

snap hooks with screw



	Ø		
	6,5 mm	5	088880250
	9,5 mm	5	088880251
	13 mm	5	088880252
	16 mm	5	088880253
	19 mm	5	088880254
	25 mm	5	088880255

S55/8

supports for double open end wrenches

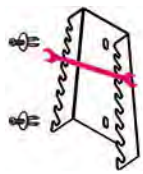

S55/8
55/S8
55AS/8
55MP/S8

1 088880420

S55/12

supports for double open end wrenches

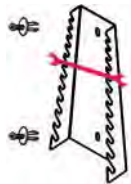

S55/12
55/S12
55/S12X
55AS/12
55MP/S12

1 088880421

ST2P

pliers pocket

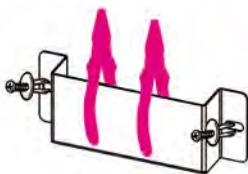

ST2P

1 088880422

TSPP

tool pockets

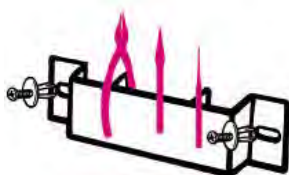

TSPP

1 088880402

S952/10

supports for T-handle wrenches with swivelling socket

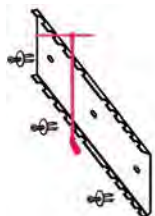

S952/10

1 088880423

S1719BM

supports for files



S1719BM
1719BMA: Q-T-P-M-R
1719BMD: Q-T-P-M-R

1 088880404

SGN

supports for mini screwdrivers



SGN
1290N-1292N-1299N/PZ
1260N-1262N-1269N/PZ
1201N-1202N-1209N/PZ

1 088880405

CB/2

thermoformed tray for 1/2" sockets and accessories, empty

Only for item C54S

12"

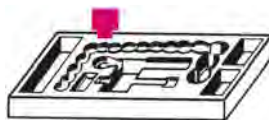

CB/2
920A/920B
10÷24+26-27
28-30-32 mm
920/21-920/22-920/25-
920/42-920/55

1 088880411

S42/17

supports for combination wrenches

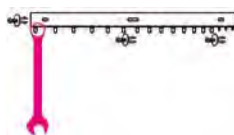

S42/17
42/S17
42MP/S17
42/S17X
42AS/17
142/S17

1 088880428

S951/6

supports for T handle wrenches with hexagon male ends

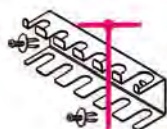

S951/6
951/S6
951AS/S6X
951TX/S6

1 088880429

SPG11 - S1203/8

supports for screwdrivers



SPG11
n.8 Ø = 7 mm
n.2 Ø = 10 mm
n.1 Ø = 12 mm

1 088880910

S1203/8
1203/S8
1263/D8
1293/S8

1 088880430

S96T/8

supports for hexagon key wrenches



S96T/8

1 088880431

96T/SPV

supports for items 96T and 97TTX

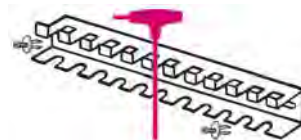

96T/SPV
96T/S11
97TTX/S11

1 000960958





Beta CHEMICALS

Tightening a bolt is not always enough to guarantee secure tightening. Cleaning, lubrication and sealing are also necessary.

The range comprises anaerobic sealants, cyanoacrylate adhesives and aerosol cans for maintaining, cleaning and lubricating mechanical parts.

Anaerobic Products

Anaerobic products allow complete filling of small superficial irregularities in metal, so that mechanical stress can be distributed throughout the connecting surface. They harden in total absence of oxygen and completely seal joints or threads from water, gas, oil, fuel and industrial fluids.

They are available in three different strengths – high (H), medium (M) and low (L) – and in different packs, to satisfy different needs.

Instant Glue

Adhesive based on ethyl cyanoacrylate, for structural joints in a number of materials.

Aerosols

A wide range of products in spray cans, for use for unlocking, greasing, lubricating, cleaning, galvanizing and sanitizing purposes.

Liquids

Developed to remove encrustations and rust from mechanical parts and metal objects. Ideal for use with ultrasonic cleaning tanks 1895.

ATTENTION!

Countries where the products of the Beta Chemicals range are allowed to be distributed: Austria, Belgium, France, Hungary, Italy, Netherlands, Poland, Portugal, Republic of Ireland, Spain, Switzerland, United Kingdom.



9803H

threadlocker-High Resistance

Ideal for permanent locking of parts that do not need subsequent dismantling, and for passivated metal surfaces, including brass, aluminium and stainless steel. Does not allow disassembly with hand tools.



Temperature range (°C)	-50/+150
Max gap fill (mm)	0,25
Handling cure time (minutes)	10/15
Functional cure time (h)	3-6
Viscosity (mPa.s) 25°C	800/1200
Breakaway torque ISO-10964	35-45 Nm
Prevailing torque ISO-10964	30-40 Nm

ml			
20	bottle	12	098030002
50	bottle	4	098030005
250	bottle	4	098030025

9802M

threadlocker-Medium Resistance

Ideal for fixing parts subject to periodic maintenance, bearings and bushes. Allows dismantling by using hand tools.



Temperature range (°C)	-50/+150
Max gap fill (mm)	0,15
Handling cure time (minutes)	10/15
Functional cure time (h)	3-6
Viscosity (mPa.s) 25°C	500/800
Breakaway torque ISO-10964	22-30 Nm
Prevailing torque ISO-10964	20-25 Nm

ml			
20	bottle	12	098020002
50	bottle	4	098020005
250	bottle	4	098020025



9801L

threadlocker-Low Resistance

Ideal for fixing particular light alloys which could get damaged during disassembly and for adjusting screws. Easier parts disassembly.



Temperature range (°C)	-50/+150
Max gap fill (mm)	0,10
Handling cure time (minutes)	10/15
Functional cure time (h)	3-6
Viscosity (mPa.s) 25°C	500/800
Breakaway torque ISO-10964	6-10 Nm
Prevailing torque ISO-10964	4-8 Nm

ml			
20	bottle	12	098010002
50	bottle	4	098010005
250	bottle	4	098010025

9813H

thread sealant-High Resistance

Ideal for permanent sealing of nipples, that do not need subsequent dismantling, and for passivated metal surfaces, including brass, aluminium and stainless steel. Does not allow disassembly with hand tools.



Temperature range (°C)	-50/+200
Max gap fill (mm)	0,15
Handling cure time (minutes)	10/15
Functional cure time (h)	3-6
Viscosity (mPa.s) 25°C	40.000/80.000
Breakaway torque ISO-10964	35-45 Nm
Prevailing torque ISO-10964	25-35 Nm

ml			
20	bottle	12	098130002
50	bellow bottle	6	098130305
50	tube	4	098130505
100	tube	4	098130510
250	tube	4	098130525

9812M

thread sealant-Medium Resistance

Ideal for sealing nipples parts subject to periodic maintenance. Allows dismantling by using hand tools.



Temperature range (°C)	-50/+150
Max gap fill (mm)	0,35
Handling cure time (minutes)	12/18
Functional cure time (h)	3-6
Viscosity (mPa.s) 25°C	20.000/40.000
Breakaway torque ISO-10964	27-35 Nm
Prevailing torque ISO-10964	20-30 Nm

ml			
20	bottle	12	098120002
50	bellow bottle	6	098120305
50	tube	4	098120505
100	tube	4	098120510
250	tube	4	098120525

9811L

thread sealant-Low Resistance

Ideal for sealing small or fine-pitch joints. Easier parts disassembly.



Temperature range (°C)	-50/+150
Max gap fill (mm)	0,20
Handling cure time (minutes)	10/15
Functional cure time (h)	3-6
Viscosity (mPa.s) 25°C	10.000/20.000
Breakaway torque ISO-10964	6-10 Nm
Prevailing torque ISO-10964	4-8 Nm

ml			
20	bottle	12	098110002
50	bellow bottle	6	098110305
50	tube	4	098110505
100	tube	4	098110510
250	tube	4	098110525



9823H

liquid gasket-High Resistance

Ideal for permanent sealing of surfaces. Also ideal for reclaiming bearing housings and worn parts.
Does not allow disassembly with hand tools.



Temperature range (°C)	-50/+150
Max gap fill (mm)	0,35
Handling cure time (minutes)	10/16
Functional cure time (h)	3-6
Viscosity (mPa.s) 25°C	100.000/200.000
Breakaway torque ISO-10964	35-45 Nm
Prevailing torque ISO-10964	20-30 Nm

ml			
20	bottle	12	098230002
50	bellow bottle	6	098230305
50	tube	4	098230505
100	tube	4	098230510
250	tube	4	098230525

9822M

liquid gasket-Medium Resistance

Ideal for sealing of surfaces of parts subject to periodic maintenance
Allows dismantling by using hand tools.



Temperature range (°C)	-50/+150
Max gap fill (mm)	0,35
Handling cure time (minutes)	10/15
Functional cure time (h)	3-6
Viscosity (mPa.s) 25°C	40.000/70.000
Breakaway torque ISO-10964	25-35 Nm
Prevailing torque ISO-10964	20-30 Nm

ml			
20	bottle	12	098220002
50	bellow bottle	6	098220305
50	tube	4	098220505
100	tube	4	098220510
250	tube	4	098220525

9821L

liquid gasket-Low Resistance

Ideal for sealing of surfaces of parts subject to frequent maintenance.
Protects threads from corrosion and seizure from corrosion.
Easier parts disassembly.



Temperature range (°C)	-50/+150
Max gap fill (mm)	0,35
Handling cure time (minutes)	20/30
Functional cure time (h)	3-6
Viscosity (mPa.s) 25°C	60.000/90.000
Breakaway torque ISO-10964	7-11 Nm
Prevailing torque ISO-10964	4-9 Nm

ml			
20	bottle	12	098210002
50	bellow bottle	6	098210305
50	tube	4	098210505
100	tube	4	098210510
250	tube	4	098210525

9833H

locker-High Resistance

Ideal for fixing parts that do not need subsequent dismantling
Also suitable for fixing already installed devices that are difficult to dismantle.
Does not allow disassembly with hand tools.



Temperature range (°C)	-50/+180
Max gap fill (mm)	0,15
Handling cure time (minutes)	10/15
Functional cure time (h)	3-6
Viscosity (mPa.s) 25°C	400/700
Breakaway torque ISO-10964	35-45 Nm
Prevailing torque ISO-10964	30-40 Nm

ml			
20	bottle	12	098330002
50	bottle	4	098330005
250	bottle	4	098330025

9832M

locker-Medium Resistance

Ideal for fixing parts subject to periodic maintenance.
Allows dismantling by using hand tools.



Temperature range (°C)	-50/+180
Max gap fill (mm)	0,25
Handling cure time (minutes)	12/20
Functional cure time (h)	3-6
Viscosity (mPa.s) 25°C	2000/4000
Breakaway torque ISO-10964	25-35 Nm
Prevailing torque ISO-10964	18-28 Nm

ml			
20	bottle	12	098320002
50	bottle	4	098320005
250	bottle	4	098320025

9831L

locker-Low Resistance

Ideal for fixing small parts subject to frequent maintenance.
Easier parts disassembly.



Temperature range (°C)	-50/+150
Max gap fill (mm)	0,10
Handling cure time (minutes)	10/15
Functional cure time (h)	3-6
Viscosity (mPa.s) 25°C	500/800
Breakaway torque ISO-10964	6-10 Nm
Prevailing torque ISO-10964	4-8 Nm

ml			
20	bottle	12	098310002
50	bottle	4	098310005
250	bottle	4	098310025

9851 instant glue

Based on ethyl cyanoacrylate.

For adhesion of a wide range of materials, including metal, plastics, leather, wood and several other types of substrates, whether combined with each other or separate; bonds quickly.



Temperature range (°C) -55/+82
Viscosity (mPa.s) 25°C 80-120

g			
20	bottle	12	098510002
50	bottle	10	098510005
500	bottle	1	098510050

9710 - LUBRIBETA universal 7-in-1 multipurpose unlocking lubricant

1. Unlocking;
 2. Lubricating;
 3. Detergent, degreasing;
 4. Rust protective;
 5. Deoxidizing, for electrical contacts;
 6. Waterproof;
 7. Antifreezing.
- Silicone-free.



ml			
400		12	097100040
400		12	097101040

9712 - Ultra Sblock unlocking lubricant, super-penetrating

Unlocking, deoxidizing, waterproof.
Ideal for dissolving rust from nuts, bolts, screws and gears.



ml			
400		12	097120040
400		12	097121040

9720 - Multi Grease multipurpose grease

Particularly useful for lubricating chains, gears and moving metal parts. Resistant to friction and weather.
Highly adhesive. Does not drip.



ml			
400		12	097200040
400		12	097201040

9722 - Lithium Grease white lithium grease

Based on grease with lithium, titanium and zinc oxide soaps. Ideal for lubricating gears, bearings and joints. Specific for marine applications. Highly resistant to water, sea salt, weather and high temperatures. Does not drip.



ml			
400		12	097220040
400		12	097221040

9724 - PTFE Grease PTFE based grease

Particularly suitable for lubricating industrial chains and mechanical movements subject to heavy stress and low rotation speeds. Suitable for applications on plastics and rubber. Totally colourless. Waterproof and resistant to oxidation.



ml			
400		12	097240040
400		12	097241040

9726 - Copper Grease copper grease

Suitable for lubricating joints, bolts, gears, driveshafts and other metal parts subject to high temperatures (up to 1,000 °C).
Protective, anti-wear. Prevents oxidation. Does not drip.



ml			
400		12	097260040
400		12	097261040

9729 - Silic Spray silicone spray

Suitable for lubricating plastic, rubber and metal parts. Protects from corrosion. Detaching. Antistatic. Waterproof. Can be used to polish wood, plastics and rubber. Solvent-free.



ml			
400		12	097290040
400		12	097291040

9738 - Cutting Oil cutting oil

Highly lubricating and protective. Suitable for milling, boring, threading, drilling and manual and automatic machine working. Highly resistant to oxidation. Water washable. Solvent-free.



ml			
400		12	097380040
400		12	097381040

9740 - Brake Cleaner

brake cleaner

Ideal for cleaning brake discs and pads, engines. Removes grease and tar, without leaving residue. Evaporates quickly. Does not damage plastics and rubber.



ml		
500	12	097400050
500	12	097401050

9741 - Multi Cleaner

multipurpose detergent/degreaser

Detergent and degreaser for dissolving grease, oil, tar, silicone and glue. Suitable for cleaning metal, hard plastic, ceramic, steel and aluminium surfaces. Free from oil residues.



ml		
400	12	097410040
400	12	097411040

9742 - Contact Cleaner

cleaner for electric and electronic contacts

Removes grease and dirt, without leaving oily residue. Evaporates quickly. Does not damage plastics and rubber.



ml		
400	12	097420040
400	12	097421040

9743 - SURFACE CLEANER

foam detergent

Foam detergent for all types of surfaces, tools and fabrics. Based on quaternary ammonium salts, it forms an active foam which cleans and removes dirt and grease. Removes bad smells. No rinse required. Not a disinfectant.



ml		
500	12	097430050
500	12	097431050

9744 - ULTRA CLEANER

alcohol-based cleaner

Dry detergent for tools, hard surfaces, fabrics and rooms. Alcohol-based (>70%), it cleans and removes dirt and grease. Removes bad smells. Does not leave residues. Evaporates quickly. Not a disinfectant.



ml		
400	12	097440040
400	12	097441040

9745 - Carb Cleaner

cleaner for carburettors and throttle bodies

Specific for interior and exterior cleaning of carburettors, suction ducts and throttle bodies. Totally removes carbonaceous residue, deposits and impurities. Does not leave oily residue.



ml		
400	12	097450040
400	12	097451040

9752 - Zinc 98%

clear zinc

Highly covering, it is ideal for galvanizing iron parts. Highly adhesive, it forms an elastic film of very light colour, similar to hot galvanizing. Particularly resistant to oxidation, abrasion and weather. Can be overpainted. Does not drip.



ml		
400	12	097520040
400	12	097521040

9881U

industrial alkaline detergent for ultrasonic tank

Industrial alkaline detergent, concentrated, water-based. For ultrasonic cleaning and other purification processes. Allows spare parts and metal pieces in general (injectors, carburettors, valves etc.) to be accurately and effectively cleaned.

Removes oil, grease, lubricants, residues of glue, resin and wax. Also suitable for cleaning aluminium parts.



Lt		
1	1	098810010

9882R

selective rust remover liquid

Water-based selective rust remover liquid for iron, steel, stainless steel, cast iron and chrome platings. Removes top oxidized layer, without affecting underlying metal.

Dilution: from pure to max. 1:1.

Minimum operating temperature: 15 °C.

Operating times: 30' - 24/48h (for heavy rust). Biodegradable and 100% water-soluble.



Lt		
1	1	098820010



A comprehensive range of hard and flexible abrasives, comprising over 500 coded items, entirely made in Italy. Designed and developed to satisfy all industrial and professional cutting and material removal requirements. Beta Utensili relies on the Beta Abrasives project to assert its determination to offer market professionals a comprehensive product range and an unequalled technical standard, resulting from the manufacturing skills contributed by AbraBeta.

HARD CUTTING AND GRINDING DISCS



Hard discs mean the main category of this new product family; hence Beta Utensili has concentrated on selecting the very best materials and types.

Cutting and grinding discs are the quickest and most versatile instruments for working a wide variety of materials, by using the most suitable tools, whether angle grinders or stationary machines

DISC SHAPES

 **T42**
cutting disc with depressed centre

 **T41**
cutting disc with flat centre

 **T27**
grinding disc with depressed centre



Uncompromising quality: for extremely demanding users



High quality for high performance, at competitive prices, for the best quality/price ratio.

CERTIFICATION



PICTOGRAMS on discs



Wear safety glasses



Wear protector gloves



Wear ear protectors



Wear safety clothes



Wear dust mask



Check user manual



Disc for cutting only – not for grinding



Do not use disc if damaged



Iron, sulphur and chlorine free ($\leq 0.1\%$)

Product shelf life

Product shelf-life: 3 years from manufacturing date. "V01" as engraved on the metal washer in the middle of the disc indicates the quarter of expiration. Example: "V07/2022" indicates the disc was manufactured in the 3rd quarter of 2019 and can be used until the end of the 3rd quarter of 2022.



	Quarter
V01	Jan-Mar
V04	Apr-Jun
V07	Jul-Sep
V10	Oct-Dec



ABRASIVE SHAFT-MOUNTED WHEELS

Abrasive shaft-mounted wheels for use with die grinders. Made in several shapes to suit different working processes, with three types of abrasives.



SHAFT-MOUNTED WHEELS

Shaft-mounted flap wheels are provided with flexible flaps which allow precise, homogenous finish to be obtained on irregular shapes and surfaces.



FLAP DISCS

Flap discs are made up of abrasive cloth flaps glued onto a support; they are an excellent choice for roughing and finishing operations. Generally speaking, they ensure quicker removal, more homogenous finish, less vibration, less noise and lower operating temperatures than grinding discs. They are available with cloths made of several different abrasive materials, with different grain sizes and two different types of support.

Shapes

Flat

Used at a maximum angle of 15° compared to the worktop, it allows working of flat surfaces and edges.

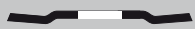

Conical

Used at an angle between 15° and 25° compared to the worktop, it makes jobs on uneven surfaces easier. It ensures a larger contact surface between the disc and the surface being worked. The flaps can be used until they are fully worn out.



Uncompromising quality: for extremely demanding users.



High quality for high performance, at competitive prices, for the best quality/price ratio.



WHEELS WITH BORES

Flange flap wheels are suitable for working irregular edges, contours and surfaces based on high flap flexibility.



WHEELS FOR SATINIZING MACHINES

Beta's wheels (or rollers) for satinizing machines mean the best solution for finishing any material.

Gradi di grana/finitura

C	Coarse
M	Medium
F	Fine
VF	Very Fine
UF	Ultra fine



RADIAL DISCS AND FIBRE DISCS

Special nonwoven discs producing remarkable polishing effects, resulting in quick, precise working processes.

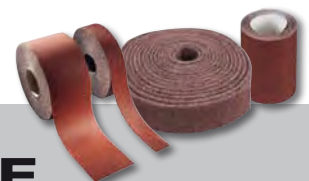

ANTI-WASTE ROLLS

A wide range of anti-waste rolls made of abrasive cloth and paper or nonwoven, of excellent quality, for a number of uses.

For further information, please refer to the dedicated catalogue available on Beta's website:

www.beta-tools.com

11001
abrasive steel cutting discs
with depressed centre

A30S EN 12413



A30S

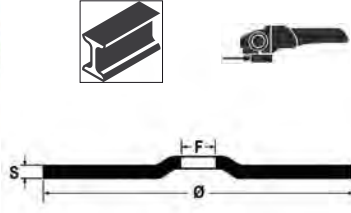

	Ø	S	F	max.	
	mm	mm	mm	rpm	
11001	115	3,2	22,23	13300	10 110010118
11001	125	3,2	22,23	12200	10 110010128
11001	230	3,2	22,23	6600	10 110010233

11001H
abrasive steel cutting discs
with depressed centre

HARD
A30T EN 12413



A30T



	Ø	S	F	max.	
	mm	mm	mm	rpm	
11001H	230	3,2	22,23	6600	10 110010733

11003
abrasive steel cutting discs
with flat centre

A30T EN 12413



A30T

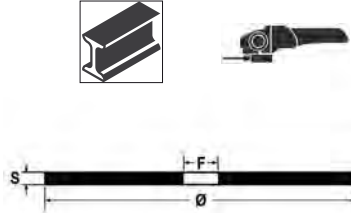

	Ø	S	F	max.	
	mm	mm	mm	rpm	
11003	115	2,5	22,23	13300	10 110030117
11003	125	2,5	22,23	12200	10 110030127
11003	180	2,5	22,23	8500	10 110030182
11003	230	2,5	22,23	6600	10 110030232

11011
abrasive steel grinding discs
with depressed centre

A24N EN 12413



A24N

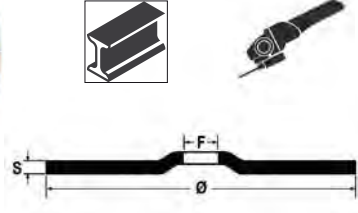

	Ø	S	F	max.	
	mm	mm	mm	rpm	
11011	115	6,5	22,23	13300	10 110110115
11011	125	6,5	22,23	12200	10 110110125
11011	180	6,5	22,23	8500	10 110110180
11011	230	6,5	22,23	6600	10 110110230

11011H
abrasive steel grinding discs
with depressed centre

HARD
A24R EN 12413



A24R

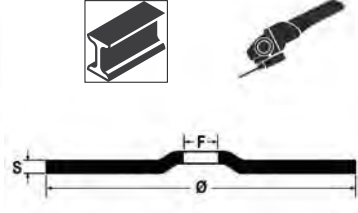

	Ø	S	F	max.	
	mm	mm	mm	rpm	
11011H	115	6,5	22,23	13300	10 110110615
11011H	125	6,5	22,23	12200	10 110110625
11011H	180	6,5	22,23	8500	10 110110680
11011H	230	6,5	22,23	6600	10 110110730

11018
abrasive ultra-thin steel cutting discs
with flat centre

60 m/s
A46N EN 12413



A46N



	Ø	S	F	max.	
	mm	mm	mm	rpm	
11018	300	2,5	25,40	4010	10 110180030
11018	350	3,0	25,40	3440	10 110180035
11018	400	3,2	25,40	3010	10 110180040

11019

abrasive ultra-thin steel cutting discs
with flat centre

80 m/s

A24N EN 12413



A24N

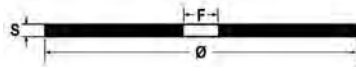

	Ø mm	S mm	F mm	max. rpm		
11019	300	3,8	25,40	5100	10	110190030
11019	350	4,2	25,40	4400	10	110190035
11019	400	4,5	25,40	3800	10	110190040

11021

abrasive steel and stainless steel cutting discs
with depressed centre

A30Q EN 12413



A30Q

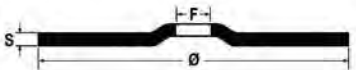

	Ø mm	S mm	F mm	max. rpm		
11021	115	3,2	22,23	13300	10	110210118
11021	125	3,2	22,23	12200	10	110210128
11021	180	3,2	22,23	8500	10	110210183
11021	230	3,2	22,23	6600	10	110210233

11023

abrasive steel and stainless steel grinding discs
with depressed centre

A24Q EN 12413



A24Q

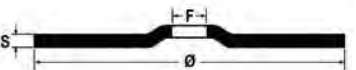

	Ø mm	S mm	F mm	max. rpm		
11023	115	6,5	22,23	13300	10	110230115
11023	125	6,5	22,23	12200	10	110230125
11023	230	6,5	22,23	6600	10	110230230

11024

abrasive steel and stainless steel cutting discs,
thin, with depressed centre

TOP LINE

A46U EN 12413



**TOP
LINE**

A46U

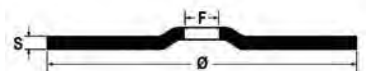

	Ø mm	S mm	F mm	max. rpm		
11024	230	2,0	22,23	6600	10	110240230

11031÷11038

abrasive steel and stainless steel cutting discs,
thin, with flat centre

TOP LINE

Ø 65 mm

A46U EN 12413



**TOP
LINE**

A46U

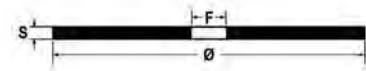

	Ø mm	S mm	F mm	max. rpm		
11031	65	1,0	6,00	24000	25	110310006
11031	65	1,0	10,00	24000	25	110310010
11031	65	1,6	10,00	24000	25	110310020

	Ø mm	S mm	F mm	max. rpm		
11032	76	1,0	6,00	20200	25	110320006
11032	76	1,0	10,00	20200	25	110320010
11032	76	1,6	10,00	20200	25	110320020

	Ø mm	S mm	F mm	max. rpm		
11034	115	1,0	22,23	13300	25	110340022
11034	115	1,2	22,23	13300	25	110340042
11034	115	1,6	22,23	13300	25	110340062

	Ø mm	S mm	F mm	max. rpm		
11035	125	1,0	22,23	12200	25	110350022
11035	125	1,2	22,23	12200	25	110350042
11035	125	1,6	22,23	12200	25	110350062

	Ø mm	S mm	F mm	max. rpm		
11037	180	2,0	22,23	8500	10	110370022

	Ø mm	S mm	F mm	max. rpm		
11038	230	2,0	22,23	6600	10	110380022

11040

abrasive steel and stainless steel cutting discs,
thin, with depressed centre

PREMIUM LINE

A36Q EN 12413

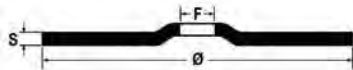

11040	Ø mm	S mm	F mm	max. rpm		
	230	2,0	22,23	6600	10	110400230

11045-11046

abrasive steel and stainless steel cutting discs,
thin, with flat centre

PREMIUM LINE

Ø 115 mm

A46Q EN 12413

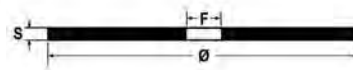

11045	Ø mm	S mm	F mm	max. rpm		
11045	115	1,0	22,23	13300	25	110450010
11045	115	1,2	22,23	13300	25	110450012
11045	115	1,6	22,23	13300	25	110450016

11046	Ø mm	S mm	F mm	max. rpm		
11046	125	1,0	22,23	12200	25	110460010
11046	125	1,2	22,23	12200	25	110460012
11046	125	1,6	22,23	12200	25	110460016

11048-11049

abrasive steel and stainless steel cutting discs,
thin, with flat centre

Ø 180 mm

A36Q EN 12413

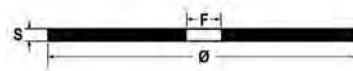

11048	Ø mm	S mm	F mm	max. rpm		
11048	180	2,0	22,23	8500	10	110480019

11049	Ø mm	S mm	F mm	max. rpm		
11049	230	2,0	22,23	6600	10	110490019

11050

abrasive steel grinding discs,
with zirconia abrasive and depressed centre

ZA24R - EN 12413

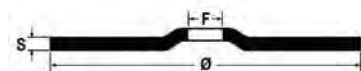

11050	Ø mm	S mm	F mm	max. rpm		
11050	115	6,5	22,23	13300	10	110500115
11050	125	6,5	22,23	12200	10	110500125
11050	180	7,0	22,23	8500	10	110500180
11050	230	7,0	22,23	6600	10	110500230

11069

abrasive stone and marble cutting discs
with depressed centre

C30S EN 12413

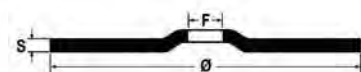

11069	Ø mm	S mm	F mm	max. rpm		
11069	115	3,2	22,23	13300	10	110690115
11069	125	3,2	22,23	12200	10	110690125
11069	230	3,2	22,23	6600	10	110690230

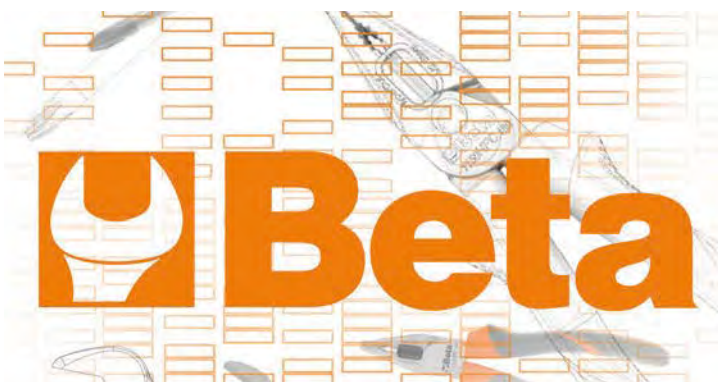

11100

abrasive shaft-mounted wheels,
abrasive pink corundum grains,
cylindrically shaped

shaft \varnothing 3 x 37 mm

EN 12413

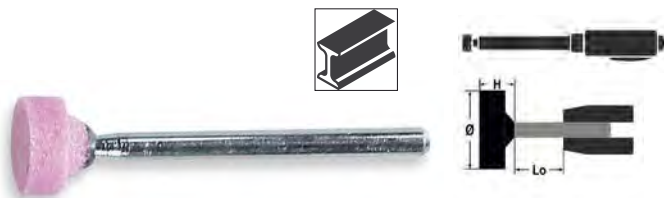

	Ø mm	h mm	max. rpm Lo=13 mm			
11100	4	8	130.000	AR60P5V	25	111000004
11100	6	10	93.100	AR60P5V	25	111000006
11100	8	12	64.500	AR60P5V	25	111000008
11100	10	10	60.100	AR60P5V	25	111000011
11100	10	12	52.700	AR60P5V	25	111000012
11100	12	15	37.300	AR60P5V	25	111000013

11101

abrasive shaft-mounted wheels,
abrasive pink corundum grains,
cylindrically shaped

shaft \varnothing 6 x 40 mm

EN 12413

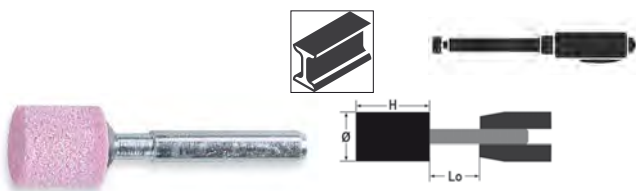

	Ø mm	h mm	max. rpm Lo=13 mm			
11101	4	8	130.000	AR60P5V	25	111010004
11101	5	10	130.000	AR60P5V	25	111010005
11101	6	10	130.000	AR60P5V	25	111010006
11101	8	10	119.300	AR60P5V	25	111010008
11101	10	10	95.400	AR60P5V	25	111010010
11101	10	15	95.400	AR60P5V	25	111010011
11101	10	20	86.600	AR60P5V	25	111010012
11101	10	25	72.700	AR60P5V	25	111010013
11101	10	32	58.700	AR60P5V	25	111010014
11101	12	10	79.500	AR60P5V	25	111010015
11101	12	15	79.500	AR60P5V	25	111010016
11101	12	20	79.500	AR60P5V	25	111010017
11101	15	3	63.600	AR60P5V	25	111010018
11101	15	15	63.600	AR60P5V	25	111010019
11101	16	20	59.600	AR46P5V	25	111010020
11101	16	25	56.900	AR46P5V	25	111010021
11101	16	32	45.100	AR46P5V	25	111010022
11101	20	4	47.700	AR60P5V	25	111010023
11101	20	15	47.700	AR46P5V	25	111010024
11101	20	20	47.700	AR46P5V	25	111010025
11101	20	25	46.100	AR46P5V	25	111010026
11101	20	30	38.900	AR46P5V	25	111010027
11101	20	40	29.000	AR46P5V	25	111010028
11101	25	10	38.100	AR60P5V	25	111010030
11101	25	25	37.200	AR36/46P5V	25	111010031
11101	25	40	23.300	AR36/46P5V	10	111010032
11101	30	10	31.800	AR60P5V	25	111010034
11101	30	30	26.200	AR36/46P5V	25	111010035
11101	30	40	19.500	AR36/46P5V	10	111010036
11101	32	20	29.800	AR36P5V	25	111010037
11101	32	32	23.100	AR36P5V	10	111010038
11101	40	10	23.800	AR36/46P5V	25	111010041
11101	40	20	23.800	AR36P5V	10	111010042
11101	40	25	23.400	AR36P5V	10	111010043
11101	40	30	19.700	AR36P5V	10	111010044
11101	40	40	14.700	AR36P5V	10	111010045
11101	50	15	19.000	AR36P5V	10	111010051
11101	50	25	18.800	AR36P5V	10	111010052
11101	60	10	15.900	AR36P5V	10	111010060

11102

abrasive shaft-mounted wheels,
abrasive pink corundum grains,
cylindrically shaped

shaft \varnothing 6 x 80 mm

EN 12413

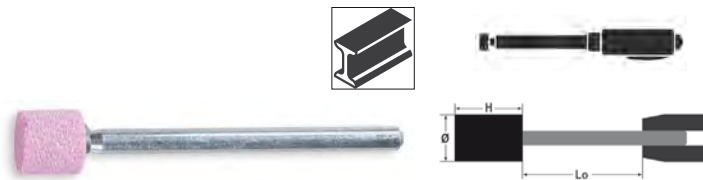

	Ø mm	h mm	max. rpm Lo=13 mm			
11102	8	20	100.500	AR60P5V	25	111020008
11102	10	15	95.400	AR60P5V	25	111020010
11102	10	30	62.200	AR60P5V	25	111020020
11102	12	15	79.500	AR60P5V	25	111020022
11102	15	15	63.600	AR60P5V	25	111020035
11102	15	30	51.000	AR46P5V	25	111020040
11102	20	30	38.900	AR46P5V	25	111020060

11105

abrasive shaft-mounted wheels,
abrasive pink corundum grains,
cylindrically/triangularly shaped

shaft \varnothing 6 x 40 mm

EN 12413



	Ø mm	h mm	max. rpm Lo=13 mm			
11105	20	65	16.200	AR36/46P5V	25	111050020

11106

abrasive shaft-mounted wheels,
abrasive pink corundum grains,
trapezoidally shaped

shaft \varnothing 3 x 37 mm

EN 12413

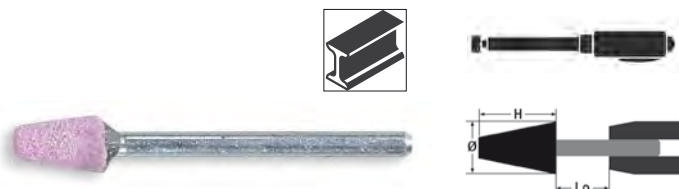

	Ø mm	h mm	max. rpm Lo=13 mm			
11106	6	10	93.100	AR60P5V	25	111060006

11107

abrasive shaft-mounted wheels,
abrasive pink corundum grains,
trapezoidally shaped

shaft $\varnothing 6 \times 40$ mm

EN 12413

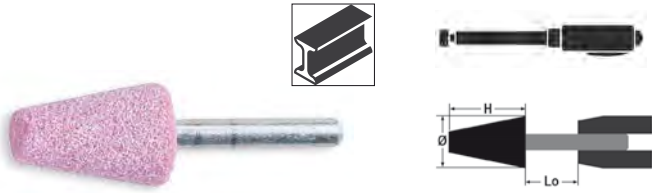

	\varnothing mm	h mm	max. rpm Lo=13 mm			
11107	12	20	79.500	AR60P5V	25	111070012
11107	15	25	60.400	AR46P5V	25	111070015
11107	20	30	38.900	AR46P5V	25	111070020
11107	25	40	23.300	AR36/46P5V	10	111070025

11110

abrasive shaft-mounted wheels,
abrasive pink corundum grains,
rounded, cone-shaped

shaft $\varnothing 3 \times 37$ mm

EN 12413

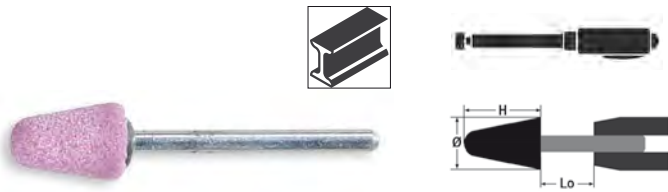

	\varnothing mm	h mm	max. rpm Lo=13 mm			
11110	10	15	44.300	AR60P5V	25	111100010

11111

abrasive shaft-mounted wheels,
abrasive pink corundum grains,
rounded, cone-shaped

shaft $\varnothing 6 \times 40$ mm

EN 12413

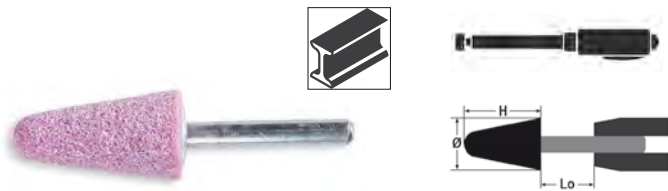

	\varnothing mm	h mm	max. rpm Lo=13 mm			
11111	10	20	86.600	AR60P5V	25	111110010
11111	15	30	51.000	AR46P5V	25	111110015
11111	16	45	31.400	AR46P5V	25	111110016
11111	20	28	41.500	AR46P5V	25	111110020
11111	20	40	29.000	AR46P5V	25	111110021
11111	30	50	15.100	AR36/46P5V	10	111110030

11115

abrasive shaft-mounted wheels,
abrasive pink corundum grains,
ogive-shaped

shaft $\varnothing 3 \times 37$ mm

EN 12413

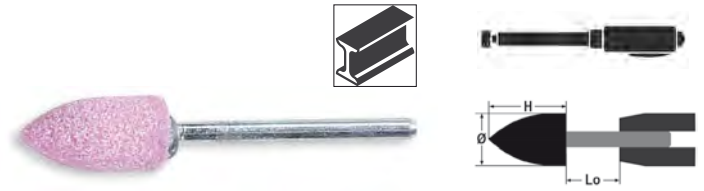

	\varnothing mm	h mm	max. rpm Lo=13 mm			
11115	10	20	34.700	AR60P5V	25	111150010

11116

abrasive shaft-mounted wheels,
abrasive pink corundum grains,
ogive-shaped

shaft $\varnothing 6 \times 40$ mm

EN 12413

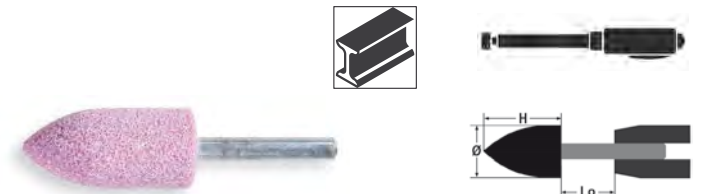

	\varnothing mm	h mm	max. rpm Lo=13 mm			
11116	10	20	86.600	AR60P5V	25	111160010
11116	18	30	43.000	AR46P5V	25	111160018
11116	20	50	22.500	AR36/46P5V	25	111160020
11116	22	70	13.400	AR36/46P5V	10	111160022

11120

abrasive shaft-mounted wheels,
abrasive pink corundum grains,
cylindrically/pyramidally shaped

shaft $\varnothing 3 \times 37$ mm

EN 12413

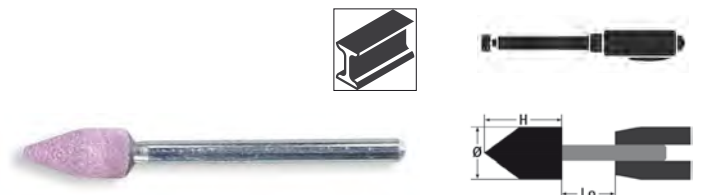

	\varnothing mm	h mm	max. rpm Lo=13 mm			
11120	6	13	77.800	AR60P5V	25	111200006



11121

abrasive shaft-mounted wheels,
abrasive pink corundum grains,
cylindrically/pyramidally shaped

shaft \varnothing 6 x 40 mm

EN 12413



	\varnothing mm	h mm	max. rpm Lo=13 mm			
11121	6	25	100.700	AR60P5V	25	111210007
11121	12	20	79.500	AR60P5V	25	111210012
11121	20	25	46.100	AR46P5V	25	111210020
11121	25	25	37.200	AR36/46P5V	25	111210025
11121	30	30	26.200	AR36/46P5V	25	111210030

11125

abrasive shaft-mounted wheels,
abrasive pink corundum grains,
rounded, cylindrically shaped

shaft \varnothing 6 x 40 mm

EN 12413



	\varnothing mm	h mm	max. rpm Lo=13 mm			
11125	6	20	117.700	AR60P5V	25	111250006
11125	25	25	37.200	AR36/46P5V	25	111250025
11125	30	50	15.100	AR36/46P5V	10	111250030
11125	40	40	14.700	AR36P5V	10	111250040

11130

abrasive shaft-mounted wheels,
abrasive pink corundum grains,
globe-shaped

shaft \varnothing 3 x 37 mm

EN 12413

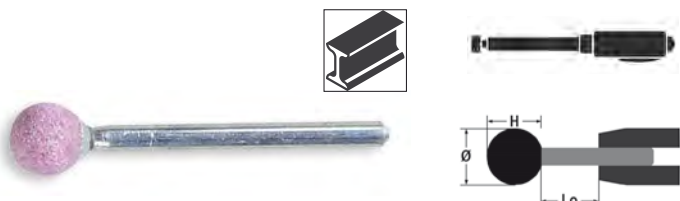

	\varnothing mm	h mm	max. rpm Lo=13 mm			
11130	6	6	124.900	AR60P5V	25	111300006
11130	8	8	84.800	AR60P5V	25	111300008
11130	10	10	60.100	AR60P5V	25	111300010

11131

abrasive shaft-mounted wheels,
abrasive pink corundum grains,
globe-shaped

shaft \varnothing 6 x 40 mm

EN 12413

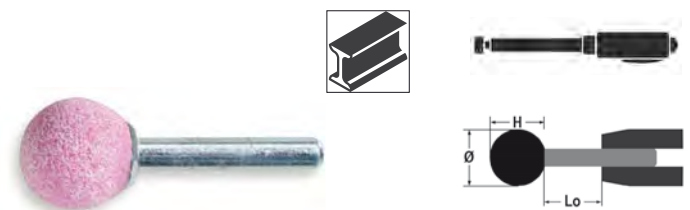

	\varnothing mm	h mm	max. rpm Lo=13 mm			
11131	10	10	95.400	AR60P5V	25	111310010
11131	15	15	63.600	AR60P5V	25	111310015
11131	20	20	47.700	AR46P5V	25	111310020
11131	25	25	37.200	AR36/46P5V	25	111310025
11131	30	30	26.200	AR36/46P5V	25	111310030

11132

abrasive shaft-mounted wheels,
abrasive pink corundum grains,
globe-shaped

shaft \varnothing 6 x 80 mm

EN 12413

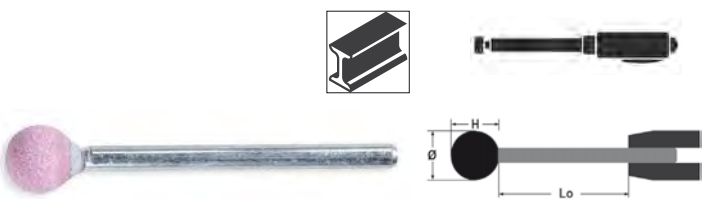

	\varnothing mm	h mm	max. rpm Lo=13 mm			
11132	10	10	95.400	AR60P5V	25	111320010
11132	15	15	63.600	AR60P5V	25	111320015
11132	20	20	47.700	AR46P5V	25	111320020

11135

abrasive shaft-mounted wheels,
abrasive pink corundum grains,
disc-shaped

shaft \varnothing 6 x 40 mm

EN 12413

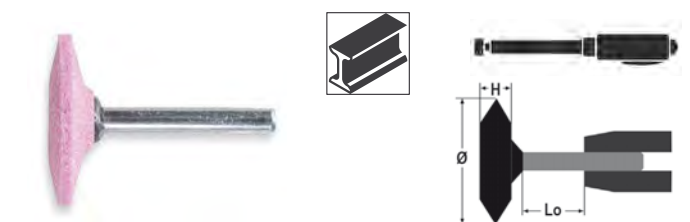

	\varnothing mm	h mm	max. rpm Lo=13 mm			
11135	30	6	31.800	AR60P5V	25	111350030
11135	40	10	23.800	AR36/46P5V	25	111350040

11140

abrasive shaft-mounted wheels,
abrasive grey/pink corundum grains,
cylindrically shaped

shaft $\varnothing 6 \times 40$ mm

EN 12413

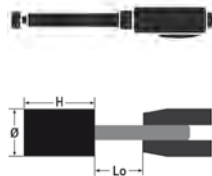

	\varnothing mm	h mm	max. rpm Lo=13 mm			
11140	20	30	38.900	A/AR24R5V	25	111400020
11140	25	25	37.200	A/AR24R5V	25	111400025
11140	30	30	26.200	A/AR24R5V	25	111400030
11140	50	10	19.000	A/AR24R5V	10	111400050

11141

abrasive shaft-mounted wheels,
abrasive grey/pink corundum grains,
cylindrically shaped

shaft $\varnothing 6 \times 80$ mm

EN 12413

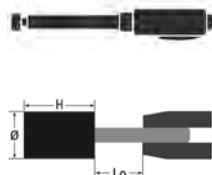

	\varnothing mm	h mm	max. rpm Lo=13 mm			
11141	20	40	46.800	A/AR24R5V	25	111410020
11141	30	40	31.800	A/AR24R5V	10	111410030
11141	40	40	23.800	A/AR24R5V	10	111410040

11145

abrasive shaft-mounted wheels,
abrasive grey/pink corundum grains,
ogive-shaped

shaft $\varnothing 6 \times 40$ mm

EN 12413

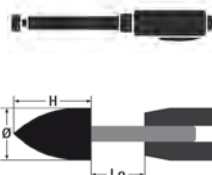

	\varnothing mm	h mm	max. rpm Lo=13 mm			
11145	20	30	38.900	A/AR24R5V	25	111450020
11145	25	50	18.100	A/AR24R5V	10	111450025

11200A-11200B

flap discs with zirconia abrasive cloth,
plastic backing pad, single flap construction

Flat

PREMIUM LINE

$\varnothing 115$ mm

EN 13743

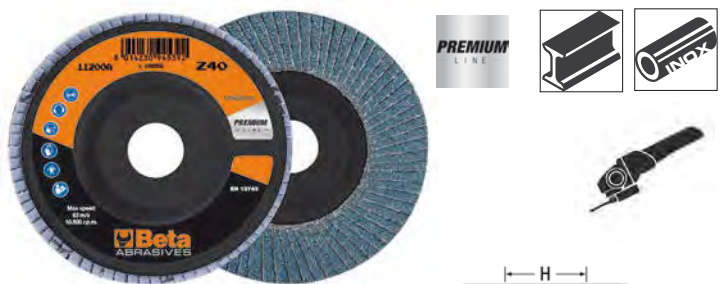

	\varnothing mm	P	F mm		
11200A	115	40	22,23	10	112000004
11200A	115	60	22,23	10	112000006
11200A	115	80	22,23	10	112000008
11200A	115	120	22,23	10	112000012

	\varnothing mm	P	F mm		
11200B	125	40	22,23	10	112000104
11200B	125	60	22,23	10	112000106
11200B	125	80	22,23	10	112000108

11202A-11202C

flap discs with zirconia abrasive cloth,
plastic backing pad, double flap construction

Flat

PREMIUM LINE

$\varnothing 115$ mm

EN 13743

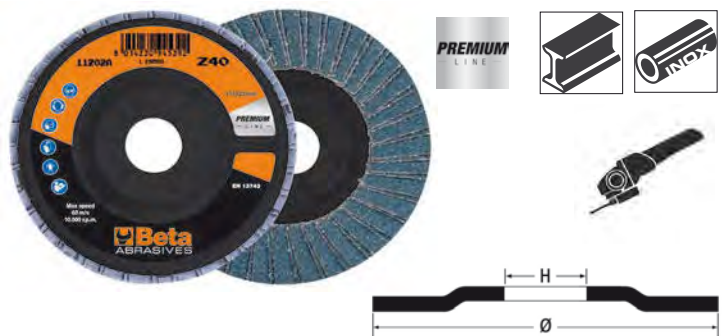

	\varnothing mm	P	F mm		
11202A	115	40	22,23	10	112020004
11202A	115	60	22,23	10	112020006
11202A	115	80	22,23	10	112020008
11202A	115	120	22,23	10	112020012

	\varnothing mm	P	F mm		
11202B	125	40	22,23	10	112020104
11202B	125	60	22,23	10	112020106
11202B	125	80	22,23	10	112020108

	\varnothing mm	P	F mm		
11202C	180	40	22,23	10	112020204
11202C	180	60	22,23	10	112020206

11204A÷11204C

flap discs with zirconia abrasive cloth,
fibreglass backing pad, single flap construction

Flat
PREMIUM LINE
Ø 115 mm
EN 13743

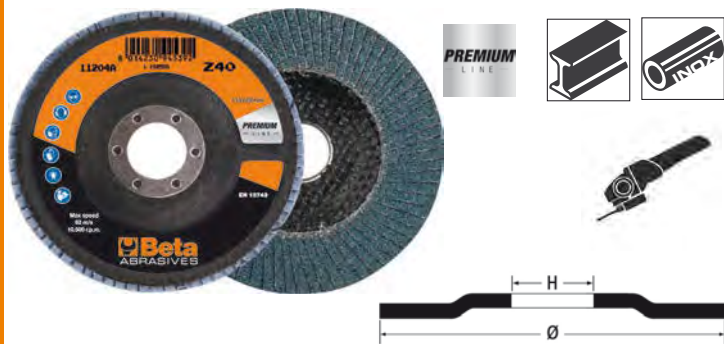

	Ø mm	P mm	F mm		
11204A	115	40	22,23	10	112040004
11204A	115	60	22,23	10	112040006
11204A	115	80	22,23	10	112040008
11204A	115	120	22,23	10	112040012

	Ø mm	P mm	F mm		
11204B	125	40	22,23	10	112040104
11204B	125	60	22,23	10	112040106
11204B	125	80	22,23	10	112040108

	Ø mm	P mm	F mm		
11204C	180	40	22,23	10	112040204
11204C	180	60	22,23	10	112040206

11208A-11208B

flap discs with zirconia abrasive cloth,
fibreglass backing pad, double flap construction

Flat
PREMIUM LINE
Ø 115 mm
EN 13743

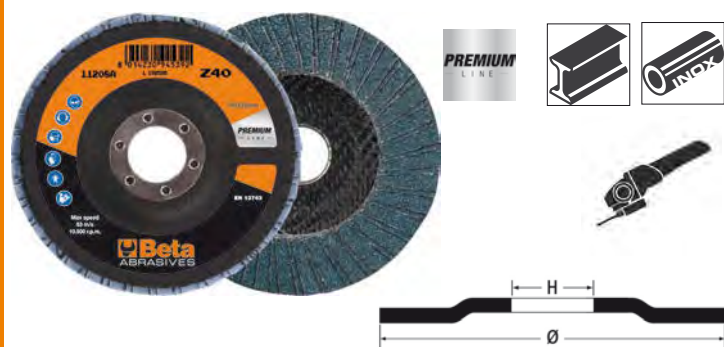

	Ø mm	P mm	F mm		
11208A	115	40	22,23	10	112080004
11208A	115	60	22,23	10	112080006

	Ø mm	P mm	F mm		
11208B	125	40	22,23	10	112080104
11208B	125	60	22,23	10	112080106

11210A÷11210C

flap discs with zirconia abrasive cloth,
fibreglass backing pad, single flap construction

Cone-shaped
PREMIUM LINE
Ø 115 mm
EN 13743



	Ø mm	P mm	F mm		
11210A	115	40	22,23	10	112100004
11210A	115	60	22,23	10	112100006
11210A	115	80	22,23	10	112100008
11210A	115	120	22,23	10	112100012

	Ø mm	P mm	F mm		
11210B	125	40	22,23	10	112100104
11210B	125	60	22,23	10	112100106
11210B	125	80	22,23	10	112100108

	Ø mm	P mm	F mm		
11210C	180	40	22,23	10	112100204
11210C	180	60	22,23	10	112100206

11212A -11212B

flap discs with zirconia abrasive cloth,
plastic backing pad, single flap construction

Flat
TOP LINE
Ø 115 mm
EN 13743

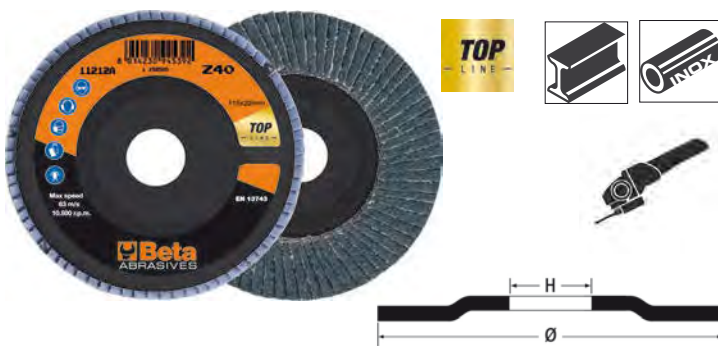

	Ø mm	P mm	F mm		
11212A	115	40	22,23	10	112120004
11212A	115	60	22,23	10	112120006
11212A	115	80	22,23	10	112120008
11212A	115	120	22,23	10	112120012

	Ø mm	P mm	F mm		
11212B	125	40	22,23	10	112120104
11212B	125	60	22,23	10	112120106
11212B	125	80	22,23	10	112120108

11214A÷11214C

flap discs with zirconia abrasive cloth,
plastic backing pad, double flap construction

Flat
TOP LINE
Ø 115 mm
EN 13743

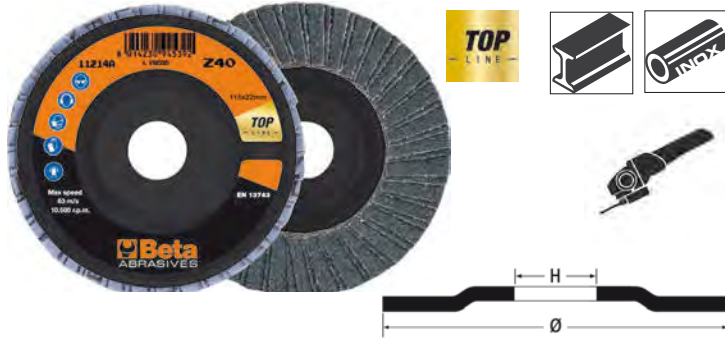

	Ø mm	P mm	F mm		
11214A	115	40	22,23	10	112140004
11214A	115	60	22,23	10	112140006
11214A	115	80	22,23	10	112140008
11214A	115	120	22,23	10	112140012

	Ø mm	P mm	F mm		
11214B	125	40	22,23	10	112140104
11214B	125	60	22,23	10	112140106
11214B	125	80	22,23	10	112140108

	Ø mm	P mm	F mm		
11214C	180	40	22,23	10	112140204
11214C	180	60	22,23	10	112140206

11216A÷11216C

flap discs with zirconia abrasive cloth,
fiberglass backing pad, single flap construction

Flat
TOP LINE
Ø 115 mm
EN 13743



	Ø mm	P mm	F mm		
11216A	115	40	22,23	10	112160004
11216A	115	60	22,23	10	112160006
11216A	115	80	22,23	10	112160008
11216A	115	120	22,23	10	112160012

	Ø mm	P mm	F mm		
11216B	125	40	22,23	10	112160104
11216B	125	60	22,23	10	112160106
11216B	125	80	22,23	10	112160108

	Ø mm	P mm	F mm		
11216C	180	40	22,23	10	112160204
11216C	180	60	22,23	10	112160206

11218A-11218B

flap discs with zirconia abrasive cloth,
fiberglass backing pad, double flap construction

Flat
TOP LINE
Ø 115 mm
EN 13743



	Ø mm	P mm	F mm		
11218A	115	40	22,23	10	112180004
11218A	115	60	22,23	10	112180006

	Ø mm	P mm	F mm		
11218B	125	40	22,23	10	112180104
11218B	125	60	22,23	10	112180106

11220A÷11220C

flap discs with zirconia abrasive cloth,
fiberglass backing pad, single flap construction

Cone-shaped
TOP LINE
Ø 115 mm
EN 13743



	Ø mm	P mm	F mm		
11220A	115	40	22,23	10	112200004
11220A	115	60	22,23	10	112200006
11220A	115	80	22,23	10	112200008
11220A	115	120	22,23	10	112200012

	Ø mm	P mm	F mm		
11220B	125	40	22,23	10	112200104
11220B	125	60	22,23	10	112200106
11220B	125	80	22,23	10	112200108

	Ø mm	P mm	F mm		
11220C	180	40	22,23	10	112200204
11220C	180	60	22,23	10	112200206

11222

flap discs with zirconia abrasive cloth,
fibreglass backing pad, double flap construction

Cone-shaped
TOP LINE
Ø 115 mm
EN 13743

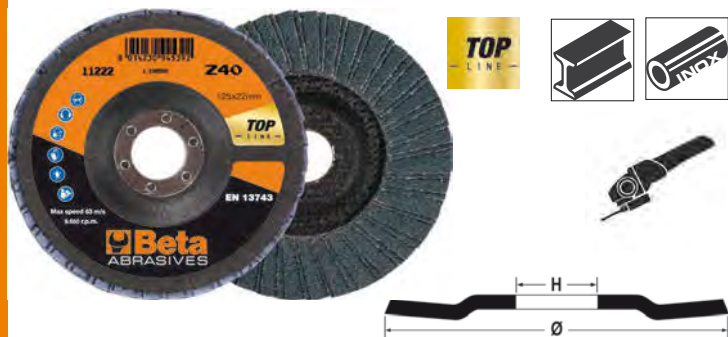

	Ø mm	P mm	F mm		
11222B	125	40	22,23	10	112220104
11222B	125	60	22,23	10	112220106
11222B	125	80	22,23	10	112220108

11230A-11230B

flap discs with corundum abrasive cloth,
plastic backing pad, single flap construction

Flat
PREMIUM LINE
Ø 115 mm
EN 13743



	Ø mm	P mm	F mm		
11230A	115	40	22,23	10	112300004
11230A	115	60	22,23	10	112300006
11230A	115	80	22,23	10	112300008
11230A	115	120	22,23	10	112300012

	Ø mm	P mm	F mm		
11230B	125	40	22,23	10	112300104
11230B	125	60	22,23	10	112300106

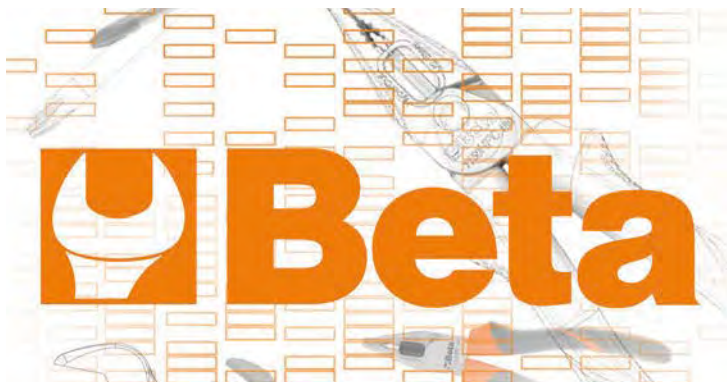

11232A

flap discs with corundum abrasive cloth,
plastic backing pad, double flap construction

Flat
PREMIUM LINE
Ø 115 mm
EN 13743

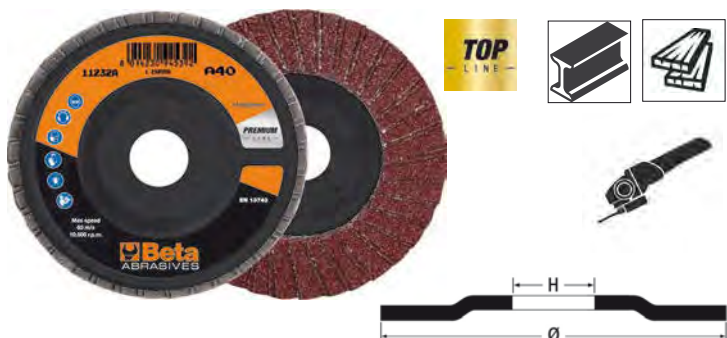

	Ø mm	P mm	F mm		
11232A	115	40	22,23	10	112320004
11232A	115	60	22,23	10	112320006
11232A	115	80	22,23	10	112320008
11232A	115	120	22,23	10	112320012

11234A-11234B

flap discs with corundum abrasive cloth,
fibreglass backing pad, single flap construction

Flat
TOP LINE
Ø 115 mm
EN 13743

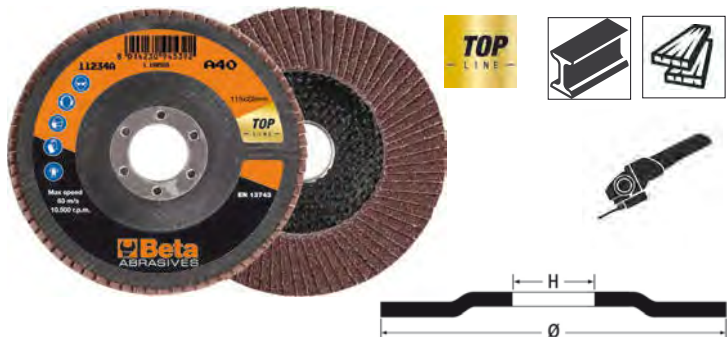

	Ø mm	P mm	F mm		
11234A	115	40	22,23	10	112340004
11234A	115	60	22,23	10	112340006
11234A	115	80	22,23	10	112340008
11234A	115	120	22,23	10	112340012

	Ø mm	P mm	F mm		
11234B	125	40	22,23	10	112340104
11234B	125	60	22,23	10	112340106

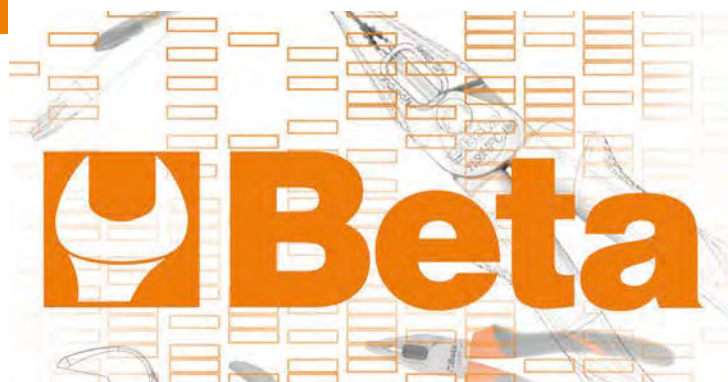

11240A-11240B

flap discs with ceramic-coated zirconia abrasive cloth, plastic backing pad and single flap construction

Flat
 Ø 115 mm
 EN 13743

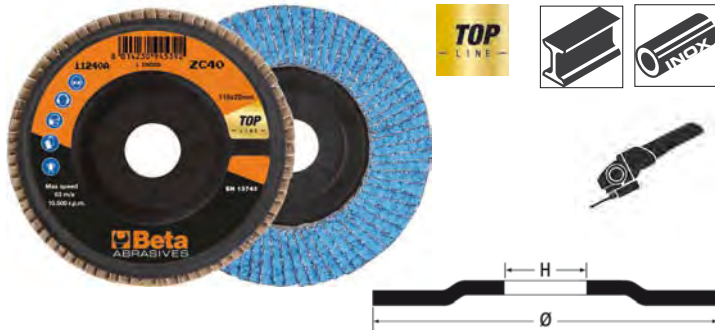

	Ø mm	P	F mm		
11240A	115	40	22,23	10	112400004
11240A	115	60	22,23	10	112400006
11240B	125	40	22,23	10	112400104
11240B	125	60	22,23	10	112400106

11242A-11242B

flap discs with ceramic-coated zirconia abrasive cloth, fibreglass backing pad and single flap construction

Flat
 Ø 115 mm
 EN 13743



	Ø mm	P	F mm		
11242A	115	40	22,23	10	112420004
11242A	115	60	22,23	10	112420006
11242B	125	40	22,23	10	112420104
11242B	125	60	22,23	10	112420106

11246A

flap discs with ceramic-coated abrasive cloth, plastic backing pad and single flap construction

Flat
 Ø 115 mm
 EN 13743

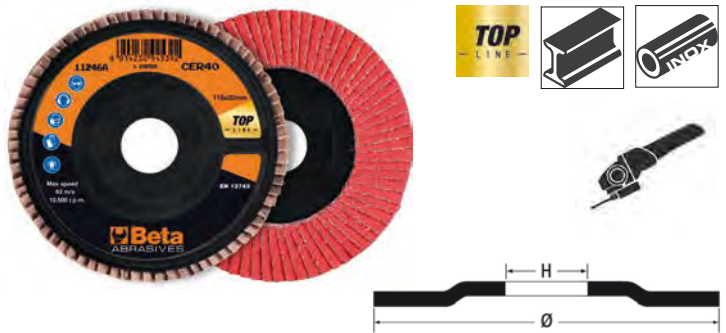

	Ø mm	P	F mm		
11246A	115	40	22,23	10	112460004
11246A	115	60	22,23	10	112460006

11248A-11248B

flap discs with ceramic-coated abrasive cloth, fibreglass backing pad and single flap construction

Flat
 Ø 115 mm
 EN 13743



	Ø mm	P	F mm		
11248A	115	40	22,23	10	112480004
11248A	115	60	22,23	10	112480006
11248B	125	40	22,23	10	112480104
11248B	125	60	22,23	10	112480106

11259

felt flap discs, fibreglass backing pad, single flap construction

Flat



	Ø mm	F mm		
11259	115	22,23	10	112590115
11259	125	22,23	10	112590125

11260÷11268

shaft-mounted flap wheels,
corundum abrasive cloth flaps

shaft Ø 3 mm

EN 13743



	Ø mm	h mm	S mm	P		
11260	10	10	3	60	10	112600010
11260	15	15	3	60	10	112600015

	Ø mm	h mm	S mm	P		
11263	30	10	6	60	10	112630006
11263	30	15	6	60	10	112630016
11263	30	15	6	80	10	112630018
11263	30	20	6	40	10	112630024
11263	30	20	6	60	10	112630026
11263	30	20	6	80	10	112630028
11263	30	20	6	120	10	112630032

	Ø mm	h mm	S mm	P		
11264	40	15	6	60	10	112640006
11264	40	15	6	80	10	112640008
11264	40	15	6	120	10	112640012
11264	40	20	6	40	10	112640014
11264	40	20	6	60	10	112640016
11264	40	30	6	40	10	112640024
11264	40	30	6	60	10	112640026

	Ø mm	h mm	S mm	P		
11265	50	20	6	60	10	112650006
11265	50	20	6	80	10	112650008
11265	50	30	6	40	10	112650014
11265	50	30	6	60	10	112650016
11265	50	30	6	80	10	112650018
11265	50	30	6	120	10	112650022

	Ø mm	h mm	S mm	P		
11266	60	20	6	40	10	112660004
11266	60	20	6	60	10	112660006
11266	60	30	6	40	10	112660014
11266	60	30	6	60	10	112660016
11266	60	30	6	80	10	112660018
11266	60	30	6	120	10	112660022
11266	60	40	6	60	10	112660026
11266	60	40	6	80	10	112660028

	Ø mm	h mm	S mm	P		
11268	80	30	6	60	10	112680006
11268	80	30	6	80	10	112680008



11271A÷11271C

abrasive non-woven wheels, shaft-mounted,
corundum synthetic fibre fabric

Ø 40 mm

shaft Ø 6 mm



	Ø mm	h mm	S mm	P		
11271A	40	20	6	C	10	112710001
11271A	40	20	6	M	10	112710002
11271A	40	20	6	F	10	112710003
11271A	40	20	6	VF	10	112710004

	Ø mm	h mm	S mm	P		
11271B	60	30	6	C	10	112710011
11271B	60	30	6	M	10	112710012
11271B	60	30	6	F	10	112710013
11271B	60	30	6	VF	10	112710014

	Ø mm	h mm	S mm	P		
11271C	80	50	6	C	10	112710021
11271C	80	50	6	M	10	112710022
11271C	80	50	6	F	10	112710023
11271C	80	50	6	VF	10	112710024

11276A÷11276C

flap/non-woven wheels, shaft-mounted,
flaps made of abrasive cloth alternating with corundum synthetic fibre
fabric

Ø 40 mm

shaft Ø 6 mm



	Ø mm	h mm	S mm	P		
11276A	40	20	6	M/60	10	112760006
11276A	40	20	6	M/80	10	112760008
11276A	40	20	6	M/120	10	112760012

	Ø mm	h mm	S mm	P		
11276B	60	30	6	M/60	10	112760016
11276B	60	30	6	M/80	10	112760018
11276B	60	30	6	M/120	10	112760022

	Ø mm	h mm	S mm	P		
11276C	80	50	6	M/60	10	112760036
11276C	80	50	6	M/80	10	112760038
11276C	80	50	6	M/120	10	112760042

11300A÷11300G

flap wheels with corundum cloth, with bores

Ø 165 x 30 mm

EN 13743

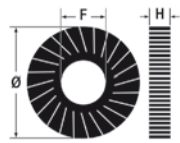

	Ø mm	H mm	P	F mm	
11300A	165	30	40	54	3 113000004
11300A	165	30	60	54	3 113000006
11300A	165	30	80	54	3 113000008
11300A	165	30	120	54	3 113000012
11300A	165	30	180	54	3 113000018
11300A	165	30	220	54	3 113000022

	Ø mm	H mm	P	F mm	
11300B	165	50	40	54	2 113000104
11300B	165	50	60	54	2 113000106
11300B	165	50	80	54	2 113000108
11300B	165	50	120	54	2 113000112
11300B	165	50	180	54	2 113000118
11300B	165	50	220	54	2 113000122

	Ø mm	H mm	P	F mm	
11300C	200	30	40	54	3 113000204
11300C	200	30	60	54	3 113000206
11300C	200	30	80	54	3 113000208
11300C	200	30	120	54	3 113000212
11300C	200	30	180	54	3 113000218

	Ø mm	H mm	P	F mm	
11300D	200	50	40	54	2 113000304
11300D	200	50	60	54	2 113000306
11300D	200	50	80	54	2 113000308
11300D	200	50	120	54	2 113000312
11300D	200	50	180	54	2 113000318
11300D	200	50	220	54	2 113000322

	Ø mm	H mm	P	F mm	
11300E	250	30	40	100	3 113000404
11300E	250	30	60	100	3 113000406
11300E	250	30	80	100	3 113000408
11300E	250	30	120	100	3 113000412

	Ø mm	H mm	P	F mm	
11300F	250	50	40	100	2 113000504
11300F	250	50	60	100	2 113000506
11300F	250	50	80	100	2 113000508
11300F	250	50	120	100	2 113000512
11300F	250	50	180	100	2 113000518
11300F	250	50	220	100	2 113000522

	Ø mm	H mm	P	F mm	
11300G	300	50	40	100	2 113000604
11300G	300	50	60	100	2 113000606
11300G	300	50	80	100	2 113000608

11320

abrasive non-woven wheels with bores,
corundum synthetic fibre fabric

Ø 200 x 50 mm



	Ø mm	H mm	P	F mm	
11320	200	50	C	76,2	2 113200006
11320	200	50	M	76,2	2 113200008
11320	200	50	F	76,2	2 113200012
11320	200	50	VF	76,2	2 113200024

11411

flap wheels with corundum cloth for satinizing machines

Ø 100 x 100 mm

EN 13743

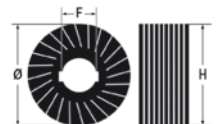

	Ø mm	H mm	P	F mm	
11411	100	100	40	19,1	2 114110004
11411	100	100	60	19,1	2 114110006
11411	100	100	80	19,1	2 114110008
11411	100	100	120	19,1	2 114110012
11411	100	100	240	19,1	2 114110024

11415B

non-woven flaps with
corundum synthetic fibres for satinizing machines

Ø 100 x 100 mm



	Ø mm	H mm	P	F mm	
11415B	100	100	C	19,1	2 114150106
11415B	100	100	M	19,1	2 114150108
11415B	100	100	F	19,1	2 114150112
11415B	100	100	VF	19,1	2 114150124

11420B

flap/non-woven wheels for satinizing machines,
abrasive cloth alternating with corundum synthetic fibres

Ø 100 x 100 mm

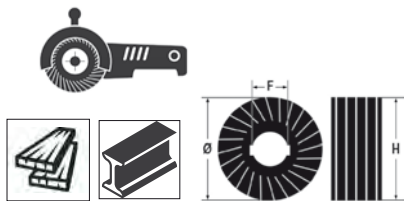

	Ø mm	H mm	P	F mm		
11420B	100	100	C/60	19,1	2	114200106
11420B	100	100	M/80	19,1	2	114200108
11420B	100	100	F/120	19,1	2	114200112
11420B	100	100	VF/240	19,1	2	114200124

11431

non-woven radial discs,
corundum synthetic fibres

Ø 115 mm

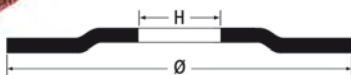

	Ø mm	P	F mm		
11431	115	C	22,23	4	114310006
11431	115	M	22,23	4	114310008
11431	115	F	22,23	4	114310012
11431	115	VF	22,23	4	114310024

11435

flap/non-woven radial discs,
abrasive cloth alternating with corundum synthetic fibres

Ø 115 mm

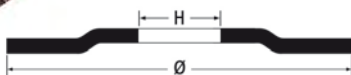

	Ø mm	P	F mm		
11435	115	M/80	22,23	4	114350008
11435	115	M/120	22,23	4	114350012
11435	115	F/150	22,23	4	114350015
11435	115	F/180	22,23	4	114350018

11440A÷11440C

fibre discs with zirconia cloth

Ø 115 mm

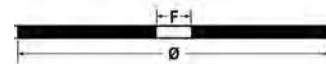

	Ø mm	P	F mm		
11440A	115	24	22	25	114400024
11440A	115	36	22	25	114400036
11440A	115	60	22	25	114400060
11440A	115	120	22	25	114400120

	Ø mm	P	F mm		
11440B	125	24	22	25	114400224
11440B	125	36	22	25	114400236
11440B	125	60	22	25	114400260
11440B	125	120	22	25	114400320

	Ø mm	P	F mm		
11440C	180	24	22	25	114400424
11440C	180	36	22	25	114400436
11440C	180	60	22	25	114400460
11440C	180	120	22	25	114400520

11450A÷11450C

fibre discs with corundum cloth

Ø 115 mm



	Ø mm	P	F mm		
11450A	115	24	22	25	114500024
11450A	115	36	22	25	114500036
11450A	115	60	22	25	114500060
11450A	115	120	22	25	114500120

	Ø mm	P	F mm		
11450B	125	24	22	25	114500224
11450B	125	36	22	25	114500236
11450B	125	60	22	25	114500260
11450B	125	120	22	25	114500320

	Ø mm	P	F mm		
11450C	180	24	22	25	114500424
11450C	180	36	22	25	114500436
11450C	180	60	22	25	114500460
11450C	180	120	22	25	114500520

11488PF

fixing pads for fibre discs with ring nut M14



	∅ mm		
11488P	115	1	114880115
11488P	125	1	114880125
11488P	180	1	114880180

11491-11493-11495

anti-waste rolls made of corundum abrasive cloth

h 38 mm x 50 m



	H mm	L m	P	
11491	38	50	40	1 114910004
11491	38	50	60	1 114910006
11491	38	50	80	1 114910008
11491	38	50	100	1 114910010
11491	38	50	120	1 114910012
11491	38	50	150	1 114910015
11491	38	50	180	1 114910018
11491	38	50	220	1 114910022
11491	38	50	240	1 114910024
11491	38	50	320	1 114910032
11491	38	50	400	1 114910040

	H mm	L m	P	
11493	50	50	40	1 114930004
11493	50	50	60	1 114930006
11493	50	50	80	1 114930008
11493	50	50	100	1 114930010
11493	50	50	120	1 114930012
11493	50	50	150	1 114930015
11493	50	50	180	1 114930018
11493	50	50	220	1 114930022
11493	50	50	240	1 114930024
11493	50	50	320	1 114930032
11493	50	50	400	1 114930040

	H mm	L m	P	
11495	120	25	40	1 114950004
11495	120	25	60	1 114950006
11495	120	25	80	1 114950008
11495	120	25	100	1 114950010
11495	120	25	120	1 114950012
11495	120	25	180	1 114950018
11495	120	25	240	1 114950024
11495	120	25	400	1 114950040

11498

non-woven anti-waste roll
with corundum synthetic fibres

h 100 mm x 10 m



	H mm	L m	P	
11498	100	10	M	1 114980008
11498	100	10	F	1 114980012
11498	100	10	VF	1 114980015
* 11498	100	10	UF	1 114980018



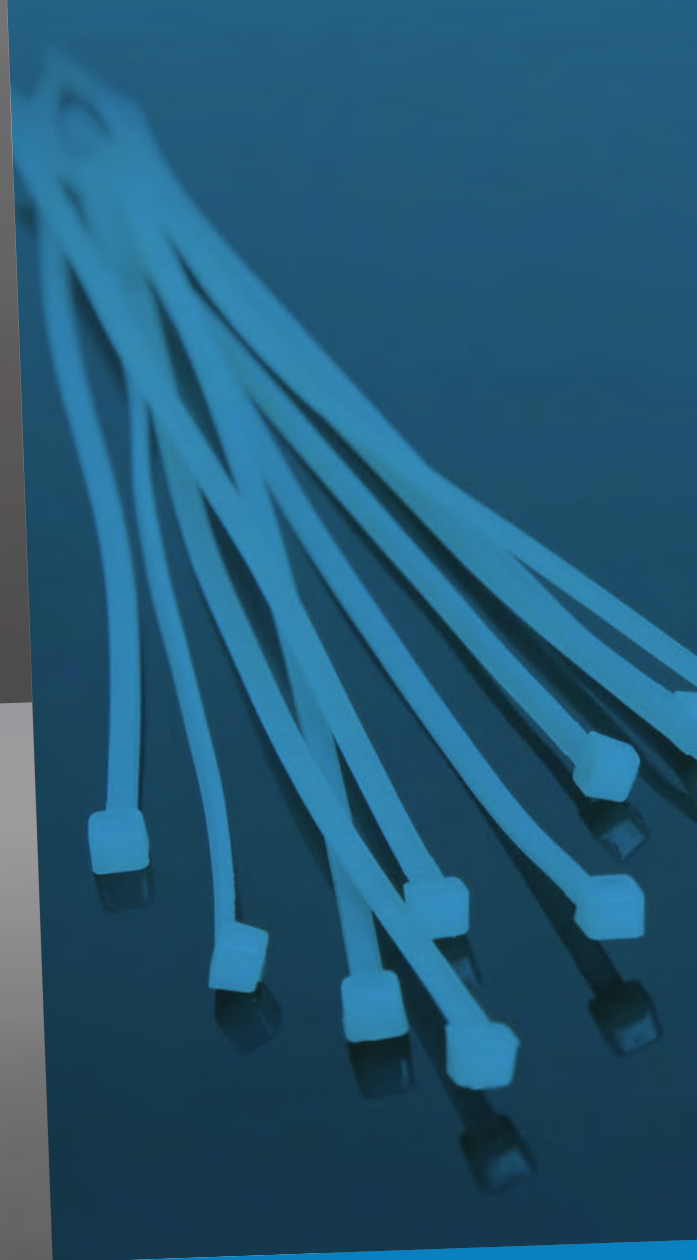
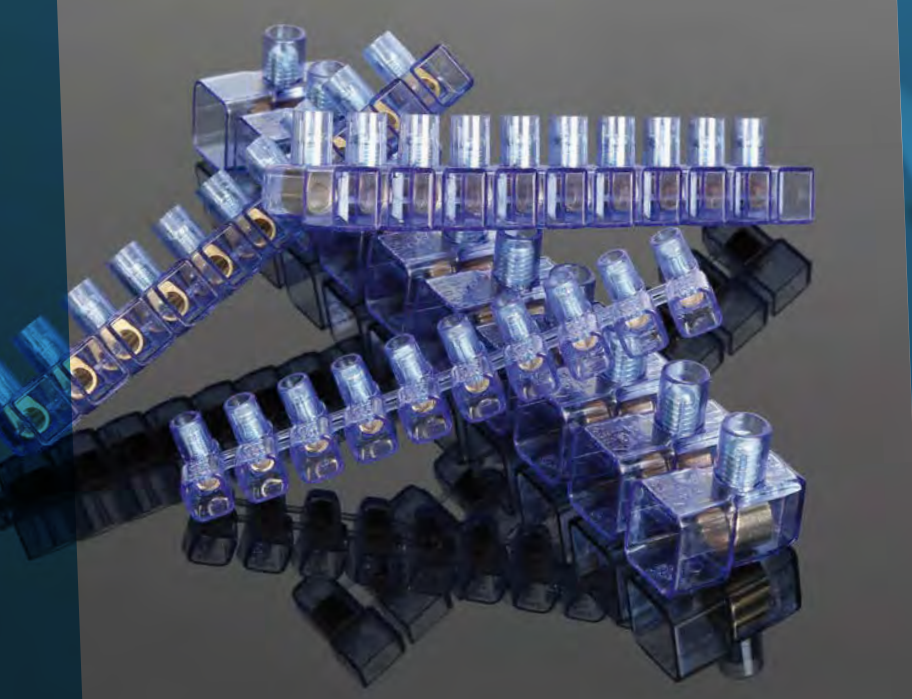

PRODUCTS UNDER THE BRAND NAME BM: CABLE TIES, TERMINAL BLOCKS, ELECTRICAL TAPES

BM Group has been designing, manufacturing and distributing connecting parts and electrical installation products since 1958. Quality, safety and reliability have always been BM's key values. Combined with a passion for excellence, these values have allowed the company to develop – step by step – into a benchmark for the electrical material market.

In 2018 BM Group was taken over by Beta Utensili. This section comprises an accurate selection of products under the brand name BM, supplementing Beta's product range.

CERTIFIED QUALITY



1610-B

pre-insulated ring terminals

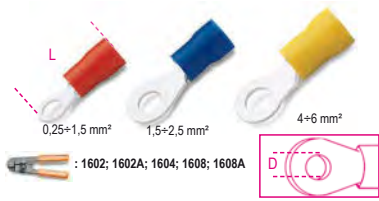

D	mm	mm²	L	mm	100	50
4	0,25-1,5	20,6	100	BM00119		
5	0,25-1,5	21,8	100	BM00125		
5	1,5-2,5	22,4	100	BM00225		
6	1,5-2,5	26	100	BM00231		
8	1,5-2,5	29,8	100	BM00237		
6	4-6	29,1	50	BM00331		
8	4-6	34,5	50	BM00337		

- Please indicate number of terminals, and not of packages, in your order

1614-P

pre-insulated ferrule terminals

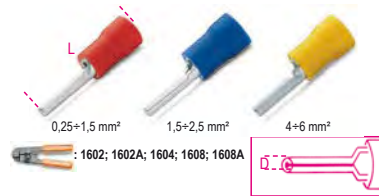

D	mm	mm²	L	mm	100	50
1,8	0,25-1,5	20	100	BM00151		
1,8	1,5-2,5	20	100	BM00251		
2,6	4-6	28	50	BM00350		

- Please indicate number of terminals, and not of packages, in your order

1616-SM

pre-insulated male pin terminals

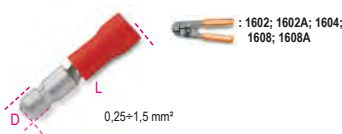

D	mm	mm²	L	mm	100
4	0,25-1,5	21	100	BM00130	

- Please indicate number of terminals, and not of packages, in your order

1618-SF

pre-insulated female pin terminals

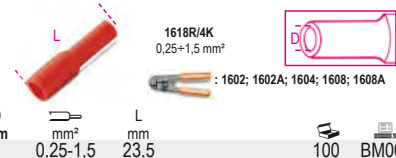

D	mm	mm²	L	mm	100
4	0,25-1,5	23,5	100	BM00140	

- Please indicate number of terminals, and not of packages, in your order

1620-M

pre-insulated quick male terminals

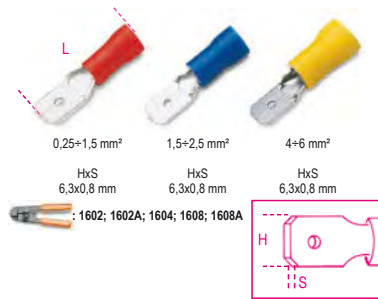

HxS	mm	mm²	L	mm	100	50
6,3x0,8	0,25-1,5	21	100	BM00180		
6,3x0,8	1,5-2,5	21	100	BM00280		
6,3x0,8	4-6	24,5	50	BM00380		

- Please indicate number of terminals, and not of packages, in your order

1622-F

pre-insulated quick female terminals

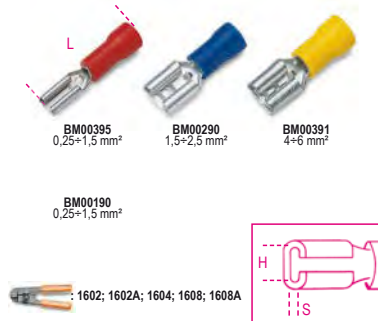

HxS	mm	mm²	L	mm	100	50
6,3x0,8	0,25-1,5	20,7	100	BM00190		
2,8x0,5	0,25-1,5	18,5	100	BM00395		
6,3x0,8	1,5-2,5	20,7	100	BM00290		
6,3x0,8	4-6	24,5	50	BM00391		

- Please indicate number of terminals, and not of packages, in your order

1624-FI

insulated quick female terminals



HxS	mm	mm²	L	mm	100	50
6,3x0,8	0,25-1,5	22	100	BM00191		
6,3x0,8	1,5-2,5	22	50	BM00291		
6,3x0,8	4-6	25	50	BM00392		

- Please indicate number of terminals, and not of packages, in your order

1628-C

pre-insulated cable connectors

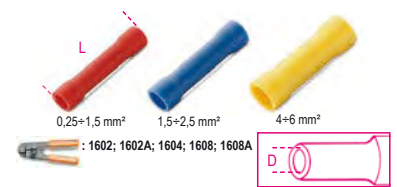

D	mm	mm²	L	mm	100	50
1,8	0,25-1,5	25	100	BM00160		
2,5	1,5-2,5	26,5	100	BM00260		
3,7	4-6	27	50	BM00360		

- Please indicate number of terminals, and not of packages, in your order

1630-CR

quick connectors



mm²	L	mm	500	BM00110
0,25-1	20	500	BM00110	
1,25-2,5	20	500	BM00210	

- Please indicate number of terminals, and not of packages, in your order

1632-TS

single tube terminals



mm²	L	mm	500	BM00601
0,5	14	500	BM00601	
0,75	14	500	BM00602	
1	14	500	BM00603	
1,5	14	500	BM00604	
2,5	14	250	BM00506	
4	17	200	BM00508	
6	20	100	BM00610	

- Please indicate number of terminals, and not of packages, in your order

1634-TD

dual tube terminals



mm²	L	mm	200	BM00651
2x0,5	15	200	BM00651	
2x0,75	15	200	BM00652	
2x1	15	200	BM00654	
2x1,5	16	200	BM00656	
2x2,5	18,5	100	BM00558	
2x4	23	100	BM00560	
2x6	26	50	BM00661	

- Please indicate number of terminals, and not of packages, in your order



1635-S

closed end connector terminals, for free connections

Insulating housing: transparent polycarbonate UL94 V0

Conductive body: brass

Captive screw: galvanized steel

Self-extinguishing: EN60695-2-10 a 850°C, EN 60335-1:2002

+A2:2006, EN60695-2-11

Working temperature: max. 85 °C

Degree of protection: IP20

Reference standards: EN60998-1: EN60998-2-1:2004



mm ²	L mm	L1 mm	S mm	mm ²	N		
1.5	15	7.5	14.5	1.5	2	10	BM991
				0.75	2+4		
2.5	17.5	9	18.2	2.5	2	10	BM992
				1.5	2+3		
				1.2	4		
4	21	10.3	20	4	2	10	BM9924
				2	2+3		
				1.5	2+4		
6	22.5	11.8	23	6	2	10	BM993
				4	2+3		
				2.5	2+4		
10	26	14.7	26	10	2	10	BM994
				6	2+3		
				4	2+4		
16	31.8	18.8	32.2	16	2	10	BM995
				10	2+3		
				6	2+4		

1635-S



mm ²	L mm	L1 mm	S mm	mm ²	N		
25	36.3	22.5	41.9	25	2	25	BM9960
				16	2+3		
				10	2+4		
35	43.5	26.1	49.4	35	2	25	BM9961
				25	2+3		
				16	2+4		



1748-BV2

nylon cable ties, natural colour

Material: polyamide PA 6.6

Self-extinguishing class: UL 94-V2

Working temperature: -40 °C + +85 °C

Minimum installation temperature: -10 °C

Resistance to chemicals: Good resistance to bases, oils, greases, chloride solvents. Limited resistance to acids. Not resistant to phenols

Reference standards: EN 62275:2015-02

Classification: type 1 (EN); type 21 (UL)



A mm	L mm	Ø MAX mm	F MAX N		
2.5	80	14	80	100	BMB0824
2.5	100	20.5	80	100	BMB1025
2.5	120	27	80	100	BMB1225
2.5	160	40	80	100	BMB1625
2.5	200	52.5	80	100	BMB2025
3.6	140	33	180	100	BMB1436
3.6	200	52.5	180	100	BMB2036
3.6	300	106	180	100	BMB2936
3.6	370	105	180	100	BMB3736
4.6	120	24	220	100	BMB1248
4.6	160	36	220	100	BMB1648
4.8	188	46	220	100	BMB1948
4.8	200	50	220	100	BMB2048
4.8	250	65	220	100	BMB2548
4.8	300	81	220	100	BMB3048
4.8	370	103.5	220	100	BMB3748
4.8	390	110	220	100	BMB3948
4.8	430	122.5	220	100	BMB4348
4.8	530	160	220	100	BMB5348
7.6	150	24	550	100	BMB1576
7.6	200	51	550	100	BMB2076
7.6	300	83	550	100	BMB2976
7.6	370	103.5	550	100	BMB3776
7.6	450	130.5	550	100	BMB4576
7.6	540	159	550	100	BMB5476
7.6	750	226	550	100	BMB7576
8.8	550	163.5	800	100	BMB5390
8.8	710	195	800	100	BMB7190
8.8	780	235.5	800	100	BMB7890
9.0	430	130.5	800	100	BMB4390
9.0	810	245	800	100	BMB8190
9.0	1020	295	800	100	BMB1090
9.0	1220	375.5	800	100	BMB1290
9.0	1530	460	800	100	BMB1590

- Please indicate number of cable ties, and not of packages, in your order

1748N

nylon cable ties, black

UV resistant

Material: polyamide PA 6.6 + carbon black

Self-extinguishing class: UL 94-V2

Working temperature: -40 °C + +85 °C

Minimum installation temperature: -10 °C

Resistance to chemicals: Good resistance to bases, oils, greases, chloride solvents. Limited resistance to acids. Not resistant to phenols

Reference standards: EN 62275:2015-02

Classification: type 1 (EN)



A mm	L mm	Ø MAX mm	F MAX N		
2.5	80	14	80	100	BMN0824
2.5	100	20.5	80	100	BMN1025
2.5	120	27	80	100	BMN1225
2.5	160	40	80	100	BMN1625
2.5	200	52.5	80	100	BMN2025
3.6	140	33	180	100	BMN1436

A mm	L mm	Ø mm	F MAX N		
3.6	200	52.5	180	100	BMN2036
3.6	300	106	180	100	BMN2936
3.6	370	105	180	100	BMN3736
4.6	120	24	220	100	BMN1248
4.6	160	36	220	100	BMN1648
4.8	188	46	220	100	BMN1948
4.8	200	50	220	100	BMN2048
4.8	250	65	220	100	BMN2548
4.8	300	81	220	100	BMN3048
4.8	370	103.5	220	100	BMN3748
4.8	390	110	220	100	BMN3948
4.8	430	122.5	220	100	BMN4348
4.8	530	160	220	100	BMN5348
7.6	150	24	550	100	BMN1576
7.6	200	51	550	100	BMN2076
7.6	300	83	550	100	BMN2976
7.6	370	103.5	550	100	BMN3776
7.6	450	130.5	550	100	BMN4576
7.6	540	159	550	100	BMN5476
7.6	750	226	550	100	BMN7576
8.8	550	163	800	100	BMN5390
8.8	710	195	800	100	BMN7190
8.8	780	235.5	800	100	BMN7890
9.0	430	130	800	100	BMN4390
9.0	810	245	800	100	BMN8190
9.0	1020	295	800	100	BMN1090
9.0	1220	375.5	800	100	BMN1290
9.0	1530	460	800	100	BMN1590

- Please indicate number of cable ties, and not of packages, in your order

1748-UL

nylon cable ties, for heavy loads, black

UV and IMPACT resistant

Material: polyamide PA 6.6 + carbon black

Self-extinguishing class: UL 94-V2

Working temperature: -40 °C + +85 °C

Minimum installation temperature: -10 °C

Resistance to chemicals: Good resistance to bases, oils, greases, chloride solvents. Limited resistance to acids. Not resistant to phenols

Reference standards: EN 62275:2015-02

Classification: type 1 (EN); type 21 (UL)

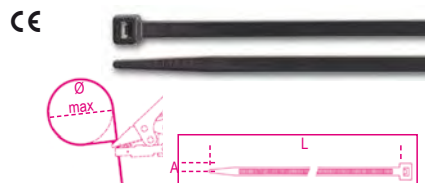

A mm	L mm	Ø MAX mm	F MAX N		
12.4	230	57	1200	100	BMN2412
12.4	480	136.5	1200	100	BMN4912
12.4	730	216.1	1200	100	BMN7412
12.4	880	263.9	1200	100	BMN8912
12.4	1000	305	1200	100	BMN1012

- Please indicate number of cable ties, and not of packages, in your order



1748-N2D

nylon cable ties,
black,
UV resistant

Material: polyamide PA 6.6 + carbon black
Self-extinguishing class: UL 94-V2
Working temperature: -40 °C ÷ +85 °C
Minimum installation temperature: -10 °C
Resistance to chemicals: Good resistance to bases, oils, greases, chloride solvents. Limited resistance to acids. Not resistant to phenols
Reference standards: EN 62275:2015-02
Classification: type 1 (EN)

CE



A	L	Ø MAX	F MAX		
mm	mm	mm	N		
9.0	180	40	400	100	BMN1890
9.0	265	62	540	100	BMN2690
9.0	360	93	540	100	BMN3690

- Please indicate number of cable ties, and not of packages, in your order

1748-BV0

self-extinguishing nylon cable ties,
white

Material: polyamide PA 6.6
Self-extinguishing class: UL 94-V0
Working temperature: -40 °C ÷ +85 °C
Minimum installation temperature: -10 °C
Resistance to chemicals: Good resistance to bases, oils, greases, chloride solvents. Limited resistance to acids. Not resistant to phenols
Reference standards: EN 62275:2015-02
Classification: type 1 (EN)

CE

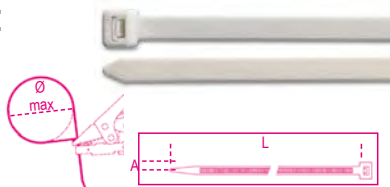

A	L	Ø MAX	F MAX		
mm	mm	mm	N		
2.5	100	20.5	80	100	BMB1025V0
3.6	150	36.0	180	100	BMB1536V0
3.6	200	52.5	180	100	BMB2036V0
4.8	200	49.5	230	100	BMB2048V0
4.8	300	81.0	230	100	BMB3048V0
4.8	380	106.7	230	100	BMB3848V0
7.6	380	106.7	540	100	BMB3876V0

- Please indicate number of cable ties, and not of packages, in your order

1748-BX

nylon cable ties,
blue,
detectable by metal detectors

Material: polyamide PA 6.6 + metal powder
Self-extinguishing class: UL 94-V2
Working temperature: -40 °C ÷ +85 °C
Minimum installation temperature: -10 °C
Resistance to chemicals: Good resistance to bases, oils, greases, chloride solvents. Limited resistance to acids. Not resistant to phenols
Reference standards: EN 62275:2015-02
Classification: type 1 (EN)

CE

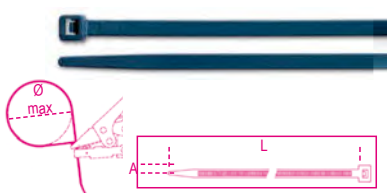

A	L	Ø MAX	F MAX		
mm	mm	mm	N		
2.5	100	20.5	80	100	BMBX1025
3.6	150	36.0	180	100	BMBX1536
3.6	200	52.5	180	100	BMBX2036
4.8	200	49.5	230	100	BMBX2048
4.8	300	81.0	230	100	BMBX3048
4.8	380	106.7	230	100	BMBX3848
7.6	380	106.7	540	100	BMBX3876

- Please indicate number of cable ties, and not of packages, in your order

1748-BL

steel tooth nylon cable ties,
natural colour

Material: polyamide PA 6.6 + steel
Self-extinguishing class: UL 94-V2
Working temperature: -40 °C ÷ +85 °C
Minimum installation temperature: -10 °C
Resistance to chemicals: Good resistance to bases, oils, greases, chloride solvents. Limited resistance to acids. Not resistant to phenols
Reference standards: EN 62275:2015-02
Classification: type 1 (EN)

CE

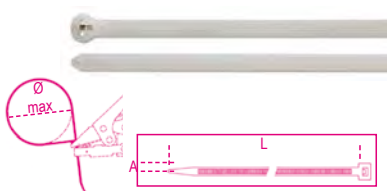

A	L	Ø MAX	F MAX		
mm	mm	mm	N		
2.5	100	20.5	180	100	BMBL1025
3.6	140	33.0	250	100	BMBL1436
2.5	200	52.5	180	100	BMBL2025
4.8	200	49.5	360	100	BMBL2048
4.8	300	81.0	360	100	BMBL3048
4.8	370	103.5	360	100	BMBL3748
7.6	370	103.5	780	100	BMBL3776

- Please indicate number of cable ties, and not of packages, in your order

1748-NL

steel tooth nylon cable ties,
black,
UV resistant

Material: polyamide PA 6.6 + steel + carbon black
Self-extinguishing class: UL 94-V2
Working temperature: -40 °C ÷ +85 °C
Minimum installation temperature: -10 °C
Resistance to chemicals: Good resistance to bases, oils, greases, chloride solvents. Limited resistance to acids. Not resistant to phenols
Reference standards: EN 62275:2015-02
Classification: type 1 (EN)

CE

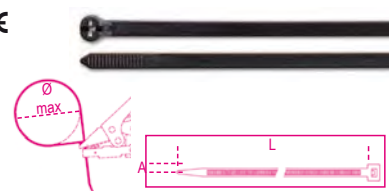

A	L	Ø MAX	F MAX		
mm	mm	mm	N		
2.5	100	20.5	180	100	BMNL1025
3.6	140	33.0	250	100	BMNL1436
2.5	200	52.5	180	100	BMNL2025
4.8	200	49.5	360	100	BMNL2048
4.8	300	81.0	360	100	BMNL3048
4.8	370	103.5	360	100	BMNL3748
7.6	370	103.5	780	100	BMNL3776

- Please indicate number of cable ties, and not of packages, in your order

1748-BR

reusable nylon cable ties,
natural colour

Material: polyamide PA 6.6
Self-extinguishing class: UL 94-V2
Working temperature: -40 °C ÷ +85 °C
Minimum installation temperature: -10 °C
Resistance to chemicals: Good resistance to bases, oils, greases, chloride solvents. Limited resistance to acids. Not resistant to phenols
Reference standards: EN 62275:2015-02
Classification: type 1 (EN); type 21 (UL)

CE

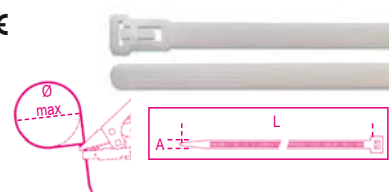

UL FILE N° E223175

A	L	Ø MAX	F MAX		
mm	mm	mm	N		
7.6	150	40	230	100	BMBR1576
7.6	200	55	230	100	BMBR2076
7.6	300	82	230	100	BMBR3076

- Please indicate number of cable ties, and not of packages, in your order

Beta

Beta

1748-BH

nylon cable ties with eyelets,
natural colour

Material: polyamide PA 6.6
Self-extinguishing class: UL 94-V2
Working temperature: -40 °C + +85 °C
Minimum installation temperature: -10 °C
Resistance to chemicals: Good resistance to bases, oils, greases, chloride solvents. Limited resistance to acids. Not resistant to phenols
Reference standards: EN 62275:2015-02
Classification: type 1 (EN); type 21 (UL)



A	L	Ø MAX	F MAX		
mm	mm	mm	N		
2.5	110	19.0	80	100	BMBH1125
* 4.8	200	49.8	230	100	BMBH2048
* 7.6	305	78.7	550	100	BMBH3076

- Please indicate number of cable ties, and not of packages, in your order

1748-BP

insertion nylon cable ties,
natural colour

Material: polyamide PA 6.6
Self-extinguishing class: UL 94-V2
Working temperature: -40 °C + +85 °C
Minimum installation temperature: -10 °C
Resistance to chemicals: Good resistance to bases, oils, greases, chloride solvents. Limited resistance to acids. Not resistant to phenols
Reference standards: EN 62275:2015-02
Classification: type 1 (EN); type 21 (UL)



A	L	Ø MAX	F MAX		
mm	mm	mm	N		
3.6	155	37.9	180	100	BMBP1536
* 4.8	200	50.8	230	100	BMBP2048

- Please indicate number of cable ties, and not of packages, in your order

1748-BT

nylon cable ties with cross plates, 25x8mm,
natural colour

Material: polyamide PA 6.6
Self-extinguishing class: UL 94-V2
Working temperature: -40 °C + +85 °C
Minimum installation temperature: -10 °C
Resistance to chemicals: Good resistance to bases, oils, greases, chloride solvents. Limited resistance to acids. Not resistant to phenols
Reference standards: EN 62275:2015-02
Classification: type 1 (EN); type 21 (UL)

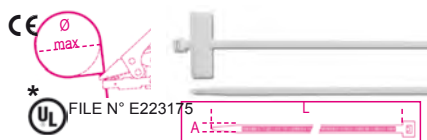

A	L	Ø MAX	F MAX		
mm	mm	mm	N		
* 2.5	100	22.0	80	100	BMBT21025
2.5	200	53.5	80	100	BMBT22025

- Please indicate number of cable ties, and not of packages, in your order

1748-BT2

nylon cable ties with lengthwise plates,
13x27mm,
natural colour

Material: polyamide PA 6.6
Self-extinguishing class: UL 94-V2
Working temperature: -40 °C + +85 °C
Minimum installation temperature: -10 °C
Resistance to chemicals: Good resistance to bases, oils, greases, chloride solvents. Limited resistance to acids. Not resistant to phenols
Reference standards: EN 62275:2015-02
Classification: type 1 (EN)

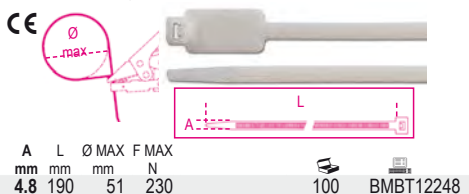

- Please indicate number of cable ties, and not of packages, in your order

1748-BT3

nylon cable ties with exterior plates, 20x9mm,
natural colour

Material: polyamide PA 6.6
Self-extinguishing class: UL 94-V2
Working temperature: -40 °C + +85 °C
Minimum installation temperature: -10 °C
Resistance to chemicals: good Resistance to bases, oils, greases, chloride solvents. Limited resistance to acids. Not resistant to phenols
Reference standards: EN 62275:2015-02
Classification: type 1 (EN)

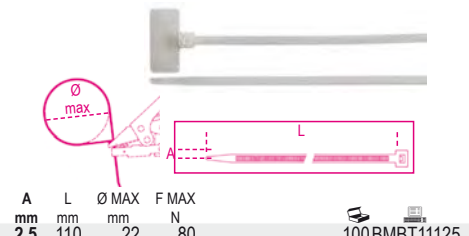

- Please indicate number of cable ties, and not of packages, in your order

1748-BA1

cable tie mounts

Material: polyamide PA 6.6
Self-extinguishing class: UL 94-V2
Working temperature: -40 °C + +85 °C
Minimum installation temperature: -10 °C
Resistance to chemicals: Good resistance to bases, oils, greases, chloride solvents. Limited resistance to acids. Not resistant to phenols



SxDxH	Ø	F		
mm	mm	mm		
15.2x9.4x6.8	3.3	3.6	100	BMB0905
22x16.2x10.8	5.2	9	100	BMB0906

- Please indicate number of cable ties, and not of packages, in your order

1748-NA1

cable tie mounts

Material: polyamide PA 6.6
Self-extinguishing class: UL 94-V2
Working temperature: -40 °C + +85 °C
Minimum installation temperature: -10 °C
Resistance to chemicals: Good resistance to bases, oils, greases, chloride solvents. Limited resistance to acids. Not resistant to phenols



SxDxH	Ø	F		
mm	mm	mm		
15.2x9.4x6.8	3.3	3.6	100	BMN0905
22x16.2x10.8	5.2	9	100	BMN0906

- Please indicate number of cable ties, and not of packages, in your order

1748-BA2

cable tie mounts - two-way

Material: polyamide PA 6.6
Self-extinguishing class: UL 94-V2
Working temperature: -40 °C + +85 °C
Minimum installation temperature: -10 °C
Resistance to chemicals: Good resistance to bases, oils, greases, chloride solvents. Limited resistance to acids. Not resistant to phenols

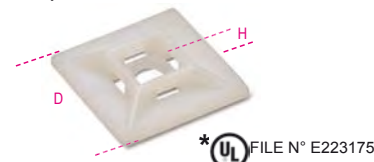

SxDxH	F		
mm	mm		
19x19x5.4	3.6	100	BMB0901
* 28x28x7	4.8	100	BMB0902
* 28x28x5.8	4.8	100	BMB0903

1748-NA2

cable tie mounts - two-way,
UV resistant

Material: polyamide PA 6.6
Self-extinguishing class: UL 94-V2
Working temperature: -40 °C + +85 °C
Minimum installation temperature: -10 °C
Resistance to chemicals: Good resistance to bases, oils, greases, chloride solvents. Limited resistance to acids. Not resistant to phenols



SxDxH	F		
mm	mm		
19x19x5.4	3.6	100	BMN0901
* 28x28x7	4.8	100	BMN0902
* 28x28x5.8	4.8	100	BMN0903

- Please indicate number of cable ties, and not of packages, in your order

1748-S

self-locking stainless steel cable ties

Material: stainless steel AISI 304
 Locking device: roller ball type
 Self-extinguishing class: non-flammable
 Plenum rating: AH-1
 UV resistance: excellent
 Working temperature: -60 °C ÷ +300 °C
 Minimum installation temperature: -60 °C
 Resistance to chemicals: excellent
 Reference standards: EN 62275:2015-02
 Classification: type 2 (EN); type 2 (UL)

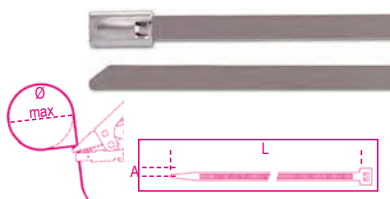

A	L	ØMAX	Trazione		
mm	mm	mm	N		
4.6	125	38	890	100	BMS1345
4.6	200	61	890	100	BMS2045
7.9	200	61	1500	100	BMS2079
4.6	290	90	890	100	BMS3045
7.9	300	90	1500	100	BMS3079
4.6	360	112	890	100	BMS3745
7.9	360	112	1500	100	BMS3779
7.9	520	163	1500	100	BMS5079
4.6	520	163	890	100	BMS5245
4.6	680	214	890	100	BMS6845
7.9	680	214	1500	100	BMS6879
4.6	840	265	890	100	BMS8445
7.9	840	265	1500	100	BMS8479

1748-SC

self-locking stainless steel cable ties,
 black polyester coating

Material: stainless steel AISI 304 + polyester
 Locking device: roller ball type
 Self-extinguishing class: non-flammable
 Plenum rating: AH-1
 UV resistance: excellent
 Working temperature: -60 °C ÷ +300 °C
 Minimum installation temperature: -60 °C
 Resistance to chemicals: excellent
 Reference standards: EN 62275:2015-02
 Classification: type 2 (EN); type 2 (UL)

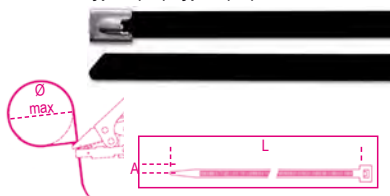

A	L	ØMAX	Trazione		
mm	mm	mm	N		
4.6	125	38	450	100	BMSC1345
4.6	200	61	450	100	BMSC2045
7.9	200	61	800	100	BMSC2079
4.6	290	90	450	100	BMSC3045
7.9	300	90	800	100	BMSC3079
4.6	360	112	450	100	BMSC3745
7.9	360	112	800	100	BMSC3779
7.9	520	163	800	100	BMSC5079
4.6	520	163	450	100	BMSC5245
4.6	680	214	450	100	BMSC6845
7.9	680	214	800	100	BMSC6879
4.6	840	265	450	100	BMSC8445
7.9	840	265	800	100	BMSC8479

1748-ST

automatic clamps for stainless steel cable ties,
 for cable ties with width ranging from 7.6 to 9
 mm,
 automatic tension and cut control



BMS-T 1 BM1105



1639ESB

PVC electrical tape

Working temperature: 0-90°C
 Tensile strength: 28N/cm equivalent to 18.6 N/mm²
 Elongation: 200%
 Adhesion to steel: 2.2N/cm
 Adhesion to backing: 2 N/cm
 Dielectric strength: 45kV/mm
 Flammability: flame retardant
 Reference standards: IEC 60454-2
 Classification: CEI EN 60454-3-1-5/F-PVCP/90



S	A	L		
mm	mm	m		
0.15	15	10	10	BMESB1510BI
0.15	15	10	10	BMESB1510BL
0.15	15	10	10	BMESB1510GI
0.15	15	10	10	BMESB1510GR
0.15	15	10	10	BMESB1510GV
0.15	15	10	10	BMESB1510MA
0.15	15	10	10	BMESB1510NE
0.15	15	10	10	BMESB1510RO
0.15	15	10	10	BMESB1510VE
0.15	15	25	10	BMESB1525BI
0.15	15	25	10	BMESB1525BL
0.15	15	25	10	BMESB1525GI
0.15	15	25	10	BMESB1525GR
0.15	15	25	10	BMESB1525GV
0.15	15	25	10	BMESB1525MA
0.15	15	25	10	BMESB1525NE
0.15	15	25	10	BMESB1525RO
0.15	15	25	10	BMESB1525VE
0.15	19	25	10	BMESB1925BI
0.15	19	25	10	BMESB1925BL
0.15	19	25	10	BMESB1925GI
0.15	19	25	10	BMESB1925GR
0.15	19	25	10	BMESB1925GV
0.15	19	25	10	BMESB1925MA
0.15	19	25	10	BMESB1925NE
0.15	19	25	10	BMESB1925RO
0.15	19	25	10	BMESB1925VE
0.15	25	25	8	BMESB2525BI
0.15	25	25	8	BMESB2525BL
0.15	25	25	8	BMESB2525GI
0.15	25	25	8	BMESB2525GR
0.15	25	25	8	BMESB2525GV
0.15	25	25	8	BMESB2525MA
0.15	25	25	8	BMESB2525NE
0.15	25	25	8	BMESB2525RO
0.15	25	25	8	BMESB2525VE

1639ESC

PVC electrical tape

Working temperature: 0-80°C
 Tensile strength: 28N/cm equivalent to 18.6 N/mm²
 Elongation: 200%
 Adhesion to steel: 2.2N/cm
 Adhesion to backing: 2.2 N/cm
 Dielectric strength: 38kV/mm
 Flammability: flame retardant
 Reference standards: ASTM-D-1000 ; UL510
 Classification: CEI EN 60454-3-1-5/F-PVCP/90



S	A	L		
mm	mm	m		
0.18	19	20	10	BMESB1920NE

1639ETA

PVC electrical tape for extreme temperatures

Working temperature: -18 ÷ +105 °C
 Tensile strength: 35N/cm equivalent to 19.4 N/mm²
 Elongation: 300%
 Adhesion to steel: 3.1N/cm
 Adhesion to backing: 2.7 N/cm
 Dielectric strength: 55.5kV/mm
 Flammability: flame retardant
 Reference standards: ASTM-D-1000 ; UL510
 Classification: CEI EN 60454-3-1-5/F-PVCP/90



S	A	L		
mm	mm	m		
0.18	19	20	1	BMETA1920NE

1639EAB

EPR self-amalgamating electrical tape

Working temperature: -40 ÷ +90 °C
 Tensile strength: 2.4 N/mm²
 Elongation: 750%
 Dielectric strength: 29.5kV/mm
 Flammability: flame retardant
 Reference standards: ASTM-D-4388; ASTM-D-4325
 Excellent resistance to: moisture, corrosion, chemicals



S	A	L		
mm	mm	m		
0.76	19	9	1	BMEAB1909NE





BLISTER PACK RANGE

free-service sales!

- **Increased visibility**
- **Display efficiency**
- **Bar code**



Blister pack support:

- *tearproof PVC*
- *4 formats for optimized display space*
- *New-generation fixing system with elastic band*

42NEWK



mm	🔧	📄
5,5x5,5	5	000429505
6x6	5	000429506
7x7	5	000429507
8x8	5	000429508
9x9	5	000429509
10x10	5	000429510
11x11	5	000429511
12x12	5	000429512
13x13	5	000429513
14x14	5	000429514
15x15	5	000429515
16x16	5	000429516
17x17	5	000429517
18x18	5	000429518
19x19	5	000429519
20x20	3	000429520
21x21	3	000429521
22x22	3	000429522
23x23	3	000429523
24x24	3	000429524
25x25	2	000429525
26x26	2	000429526
27x27	2	000429527
28x28	2	000429528
29x29	2	000429529
30x30	2	000429530
32x32	2	000429532

55K



mm	🔧	📄
6x7	5	000559012
8x9	5	000559021
10x11	5	000559030
10x12	5	000559033
10x13	5	000559035
12x13	5	000559042
12x14	5	000559045
13x17	5	000559051
14x15	5	000559054
14x17	5	000559057
16x17	5	000559060
17x19	2	000559063
18x19	2	000559066
19x22	2	000559069
20x22	2	000559075
21x23	2	000559078
22x24	2	000559081
24x26	2	000559087
24x27	2	000559090
25x28	2	000559096
27x29	2	000559099
27x30	2	000559102
30x32	2	000559108

90K



mm	🔧	📄
6x7	5	000909006
8x9	5	000909012
10x11	5	000909018
12x13	5	000909027
14x15	5	000909033
16x17	5	000909039
18x19	5	000909045
20x22	3	000909051
21x23	2	000909057
24x26	2	000909063
24x27	2	000909067

mm	🔧	📄
25x28	2	000909070
27x29	2	000909073
30x32	2	000909080

93K



mm	🔧	📄
21x22	3	000939021

94K



mm	🔧	📄
8x10	2	000949008
9x11	2	000949009
10x11	2	000949010
11x13	2	000949011
12x14	2	000949012
13x15	2	000949013
14x15	2	000949014
14x17	2	000949015
17x19	2	000949017
19x22	2	000949019
22x24	2	000949022
24x27	2	000949024
30x32	2	000949030

96/SC9



96/SC9	🔧	📄
1,5-2-2,5-3-4-5-6-8-10 mm	1	000960374

96/ST6K



96/ST6K	🔧	📄
2,5-3-4-5-6-8 mm	3	000969370

96N/ST6K



96N/ST6K	🔧	📄
2,5-3-4-5-6-8 mm	3	000969640

96BPA/SC9



96BPA/SC9	🔧	📄
1,5-2-2,5-3-4-5-6-8-10 mm	1	000961974

96BP-CL/SC9



96BP-CL/SC9	🔧	📄
1,5-2-2,5-3-4-5-6-8-10 mm	1	000961619

96BPC/SC9



96BPC/SC9	🔧	📄
1,5-2-2,5-3-4-5-6-8-10 mm	1	000960354

96C/AS



"	🔧	📄
1/16	20	000961702
3/32	20	000961706
1/8	20	000961710
5/32	20	000961714
3/16	20	000961716
7/32	20	000961718
1/4	20	000961720
5/16	10	000961724
3/8	10	000961728

96LBP/SC9



96LBP/SC9	🔧	📄
1,5-2-2,5-3-4-5-6-8-10 mm	1	000961354

96/BGS7



96/BGS7
1,5-2-2,5-3-4-5-6 mm

1 000960367

96/BG7



96/BG7
2,5-3-4-5-6-8-10 mm

1 000960368

96TK



mm	U	U	U
2	5	000969934	
2,5	5	000969935	
3	5	000969936	
4	5	000969938	
5	5	000969940	
6	5	000969941	
8	3	000969943	
10	3	000969945	

97BTX/SC8



97BTX/SC8
T9-T10-T15-T20-T25-T27-T30-T40

1 000970164

97BTXL/SC8



97BTXL/SC8
T9-T10-T15-T20-T25-T27-T30-T40

1 000970364

111K



L mm	U	U	U
100	3	001119010	
150	3	001119015	
200	3	001119020	
250	3	001119025	
300	3	001119030	

123/K4



123/K4 1 001230504

142K



mm	U	U	U
6	3	001429006	
7	3	001429007	
8	3	001429008	
9	3	001429009	
10	3	001429010	
11	3	001429011	
12	3	001429012	
13	3	001429013	
14	2	001429014	
15	2	001429015	
16	2	001429016	
17	2	001429017	
18	2	001429018	
19	2	001429019	
21	1	001429021	
22	1	001429022	
24	1	001429024	

192/S2

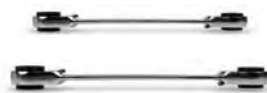

192/S2 1 001920070
8x10/12x13 mm
16x17/18x19 mm

195K



mm	U	U	U
8x10	2	001959010	
12x13	2	001959013	
14x15	2	001959015	
16x18	2	001959018	
17x19	2	001959019	

374K



L mm 240 1 003749024

850MQ



L mm 233 1 008500910

855P



L1 mm 240 1 008550010

860/58K



L mm 126 1 008609884

860LP



SxA mm	U	U	U
0,5x3	5	008600005	
0,6x4,5	5	008600010	
0,8x5,5	5	008600015	
1x5,5	5	008600020	
1,2x6,5	5	008600025	

860PH



PH	U	U	U
0	5	008600220	
1	5	008600225	
2	5	008600230	
3	5	008600245	
4	5	008600250	

860PZ



PZ	5	008600320
1	5	008600320
2	5	008600325
3	5	008600330
4	5	008600335

860PE



mm	5	008600101
2	5	008600101
2,5	5	008600102
3	5	008600103
4	5	008600104
5	5	008600105
6	5	008600106
8	5	008600108
10	5	008600110

860TX



°	5	008600704
T6	5	008600704
T7	5	008600705
T8	5	008600710
T9	5	008600715
T10	5	008600720
T15	5	008600725
T20	5	008600730
T25	5	008600735
T27	5	008600740
T30	5	008600745
T40	5	008600750

860RTX



°	5	008600550
T9	5	008600550
T10	5	008600555
T15	5	008600560
T20	5	008600565
T25	5	008600570
T27	5	008600575
T30	5	008600580
T40	5	008600585

860/C27



860/C27	1	008600880
---------	---	-----------

860MIX/A10



860MIX/A10	1	008600900
------------	---	-----------

860TX/A10



860TX/A10	1	008600970
-----------	---	-----------

860MIX/A31



860MIX/A31	1	008600902
------------	---	-----------

862F/A7



862F/A7	1	008620950
---------	---	-----------

900K



mm	10	009009040
4	10	009009040
4,5	10	009009045
5	10	009009050
5,5	10	009009055
6	10	009009060
7	10	009009070
8	10	009009080
9	10	009009090
10	10	009009100
11	10	009009110
12	10	009009120
13	10	009009130
14	10	009009140

900/20LK



L mm	5	009009819
100	5	009009819

900/25K



L mm	5	009009830
41	5	009009830

900BG/30K



L mm	5	009009834
128	5	009009834

900/55K



L mm	5	009009870
125	5	009009870

900/55ZK



L mm	3	009009882
125	3	009009882

900/58K



L mm	2	009009884
126	2	009009884

910AK



mm	5	009109006
6	5	009109006
7	5	009109007
8	5	009109008
9	5	009109009
10	5	009109010
11	5	009109011
12	5	009109012
13	5	009109013
14	5	009109014
15	5	009109015
16	5	009109016
17	5	009109017
18	5	009109018
19	5	009109019
20	5	009109020
21	5	009109021
22	5	009109022

910/21K



L mm	5	009109822
125	5	009109822

910/25K



L mm	5	009109830
54,6	5	009109830

910/55K



L mm	3	009109882
200	3	009109882

910/58K



L mm	1	009109884
222	1	009109884

920AK



mm	10	009209010
10	10	009209010
11	10	009209011
12	10	009209012
13	10	009209013
14	10	009209014
15	10	009209015
16	10	009209016
17	10	009209017
18	10	009209018
19	10	009209019
20	5	009209020
21	5	009209021
22	5	009209022
23	5	009209023
24	5	009209024
25	5	009209025
26	5	009209026
27	5	009209027
28	5	009209028
29	5	009209029
30	5	009209030
32	5	009209032

920/21K



L mm	5	009209822
125	5	009209822

920/25K



L mm	5	009209830
75	5	009209830

920/55K



L mm	3	009209882
275	3	009209882

920/58K



L mm	1	009209926
281	1	009209926

935K



mm	5	009359105
6x7	5	009359105
8x9	5	009359111
10x11	5	009359115
12x13	5	009359117
14x15	5	009359126
16x17	5	009359128
18x19	5	009359131
20x22	3	009359138

937K



mm	5	009379006
6x6	5	009379006
7x7	5	009379007
8x8	5	009379008
9x9	5	009379009
10x10	5	009379010
11x11	5	009379011
12x12	5	009379012
13x13	5	009379013
14x14	5	009379014
15x15	5	009379015
16x16	5	009379016
17x17	5	009379017
18x18	5	009379018
19x19	5	009379019
20x20	5	009379020
21x21	3	009379021
22x22	3	009379022

943BXK



mm	5	009439005
5,5	5	009439005
6	5	009439006
7	5	009439007
8	5	009439008
10	3	009439010
13	3	009439013

951K



mm	5	009519521
2	5	009519521
2,5	5	009519525
3	5	009519530
3,5	5	009519535
4	5	009519540
4,5	5	009519545
5	5	009519550
6	5	009519560
8	5	009519580
10	5	009519610



1032K



L mm		
140x0,9	5	010329013
140x1,3	5	010329014
180	5	010329017

1033K



L mm		
140x0,9	5	010339013
140x1,3	5	010339014
180	5	010339017

1034K



L mm		
130x0,9	5	010349013
130x1,3	5	010349014
170	5	010349017

1036K



L mm		
140x0,9	5	010369013
140x1,3	5	010369014
175	5	010369017

1037K



L mm		
140x0,9	5	010379013
140x1,3	5	010379014
175	5	010379017

1038K



L mm		
135x0,9	5	010389013
135x1,3	5	010389014
175	5	010389017

1044K



L mm		
250	5	010449250

1044FK



L mm		
250	5	010449015

1046K



L mm		
240	5	010469240

1048K



L mm		
175	3	010489010
250	5	010489250

1048VK



L mm		
175	3	010489110
250	5	010489025

1052K



L mm		
140	3	010529014
190	3	010529019
240	3	010529024

1082K



L mm		
140	5	010829004
160	5	010829006

1082GK



L mm		
140	5	010829064
160	5	010829066

1082BMK



L mm		
140	3	010829034
160	3	010829036

1082GBMK



L mm		
140	3	010829264
160	3	010829266

1084K



L mm		
160	3	010849006

1084GK



L mm 160 5 010849066

1084BMK



L mm 160 3 010849036

1084GBMK



L mm 160 3 010849266

1088K



L mm 160 2 010889006

1088BMK



L mm 160 2 010889036

1096K



L mm 200 5 010969020

1098K



L mm 190 5 010989190
220 5 010989220

1098PLK



L mm 220 5 010989320

1112K



L mm 200 2 011129020

1122K



L mm 250 2 011229020

1123K



L mm 250 2 011239020

1124K



L mm 250 2 011249020

1128BAX



L mm 150 5 011280088

1128BCX



L mm 155 5 011280080

1128BMX



L mm 147 5 011280051

1128BSX



L mm 148 5 011280061

1128FX



L mm 145 5 011280090

1128FXS



L			
mm			
145	5	011280095	

1129BMK



L			
mm			
145	5	011299000	

1130BMX



L			
mm			
185	1	011300002	

1132K



L			
mm			
170	2	011329107	

1132BMK



L			
mm			
170	2	011329137	

1142BMK



L			
mm			
160	3	011429036	

1149F



L			
mm			
175	1	011490010	

1150K



L			
mm			
160	5	011509046	
180	5	011509048	
200	5	011509050	
220	2	011509052	

1150GK



L			
mm			
160	5	011509066	
180	5	011509068	
200	5	011509070	
220	2	011509072	

1150BMK



L			
mm			
160	3	011509146	
180	3	011509148	
200	3	011509150	
220	2	011509152	

1150GBMK



L			
mm			
160	3	011509266	
180	3	011509268	
200	3	011509270	
220	2	011509272	

1162K



L			
mm			
160	5	011629006	
200	5	011629010	

1162GK



L			
mm			
160	5	011629066	
200	5	011629070	

1162BMK



L			
mm			
160	3	011629036	
200	3	011629040	

1162GBMK



L			
mm			
160	3	011629266	
200	3	011629270	

1164K



L			
mm			
160	5	011649006	
200	5	011649010	

1164BMK



L			
mm			
160	3	011649036	
200	3	011649040	

1166K



L mm	5	011669006
160	5	011669006
200	5	011669010

1166GK



L mm	5	011669066
160	5	011669066
200	5	011669070

1166BMK



L mm	3	011669036
160	3	011669036
200	3	011669040

1166GBMK



L mm	3	011669266
160	3	011669266
200	3	011669270

1168K



L mm	5	011689006
160	5	011689006
200	5	011689010

1168GK



L mm	5	011689066
160	5	011689066
200	5	011689070

1168BMK



L mm	3	011689036
160	3	011689036
200	3	011689040

1168GBMK



L mm	3	011689266
160	3	011689266
200	3	011689270

1201E/K



SxAxL mm	5	012019203
0,4x2,5x50	5	012019203
0,4x2,5x75	5	012019206
0,5x3x75	5	012019209
0,5x3x100	5	012019212
0,6x3,5x75	5	012019218
0,6x3,5x100	5	012019221
0,8x4x100	5	012019230
0,8x4x125	5	012019233
0,8x4x150	5	012019236
1,0x5,5x100	5	012019239
1,0x5,5x125	5	012019240
1,0x5,5x150	5	012019242
1,2x6,5x100	5	012019248
1,2x6,5x125	5	012019250
1,2x6,5x150	5	012019251
1,2x8x150	3	012019257
1,2x8x200	3	012019260
1,6x10x200	3	012019266

1201EN/K



SxAxL mm	3	012019303
0,8x4x30	3	012019303
1,2x6,5x30	3	012019306

1202E/K



PHxDxL mm	5	012029203
0x3x60	5	012029203
0x3x100	5	012029206
1x4,5x80	5	012029209
1x4,5x120	5	012029212
2x6x100	5	012029218
2x6x150	5	012029221
3x8x150	3	012029224
4x9,5x200	3	012029227

1202EN/K



PHxDxL mm	3	012029303
1x4,5x30	3	012029303
2x6x30	3	012029306

1204E/K



SxDxL mm	5	012049103
0,4x2,5x60	5	012049103
0,6x3x75	5	012049106
0,5x3x100	5	012049109
0,8x4x100	5	012049112
0,8x4x125	5	012049115
1,0x5x125	5	012049118
1,0x5x150	5	012049121
1,2x6,5x150	5	012049124

1207E TX/K



Type	5	012079105
T5	5	012079105
T6	5	012079106
T7	5	012079107
T8	5	012079108
T9	5	012079109
T10	5	012079110
T15	5	012079115
T20	5	012079120
T25	5	012079125
T27	5	012079127
T30	5	012079130
T40	2	012079140
T45	2	012079145

1208E RTX/K



Type	5	012089109
T9	5	012089109
T10	5	012089110
T15	5	012089115
T20	5	012089120
T25	5	012089125
T27	5	012089127
T30	5	012089130
T40	2	012089140

1209E PZ/K



PZ	5	012099200
0	5	012099200
1	5	012099203
2	5	012099206
3	3	012099209
4	3	012099212

1209EN-PZ/K



	Hand	Quantity	Code
1	Right	3	012099303
2	Left	3	012099306

1253



SxAxL mm	Hand	Quantity	Code
0,5x3,5x100	Right	5	012530001

1254



SxAxL mm	Hand	Quantity	Code
0,5x3x44	Right	5	012540001

1260K



SxAxL mm	Hand	Quantity	Code
0,4x2,5x50	Right	5	012609003
0,4x2,5x75	Right	5	012609006
0,5x3x75	Right	5	012609009
0,5x3x100	Right	5	012609012
0,6x3,5x75	Right	5	012609018
0,6x3,5x100	Right	5	012609021
0,8x4x100	Right	5	012609030
0,8x4x125	Right	5	012609033
0,8x4x150	Right	5	012609036
1x5,5x100	Right	5	012609039
1x5,5x150	Right	5	012609042
1,5x6,5x100	Right	5	012609048
1,2x6,5x150	Right	5	012609051
1,2x8x150	Right	3	012609057
1,2x8x200	Right	3	012609060
1,6x10x200	Right	3	012609066

1260NK



SxAxL mm	Hand	Quantity	Code
0,8x4x30	Right	5	012609103
1,2x6,5x30	Right	5	012609106

1260EK



SxAxL mm	Hand	Quantity	Code
1,2x6,5x150	Right	3	012609156
1,2x8x175	Right	3	012609157
1,6x10x200	Right	2	012609159
2x12x250	Right	2	012609162

1262K



PHxDxL mm	Hand	Quantity	Code
0x3x60	Right	5	012629003
0x3x100	Right	5	012629006
1x4,5x80	Right	5	012629009
1x4,5x120	Right	5	012629012
2x6x100	Right	5	012629018
2x6x150	Right	5	012629021
3x8x150	Right	3	012629024
4x10x200	Right	3	012629027

1262NK



PHxDxL mm	Hand	Quantity	Code
1x4,5x30	Right	5	012629103
2x6x30	Right	5	012629106

1262EK



PHxDxL mm	Hand	Quantity	Code
2x6x150	Right	3	012629153
3x8x175	Right	3	012629156
4x10x200	Right	3	012629159

1264K



SxDxL mm	Hand	Quantity	Code
0,5x2,5x60	Right	5	012649003
0,6x3x75	Right	5	012649006
0,6x3x100	Right	5	012649009
0,8x4x100	Right	5	012649012
0,8x4x125	Right	5	012649015
1x5x125	Right	5	012649018
1x5x150	Right	5	012649021
1,2x6,5x150	Right	5	012649024

1267TXK



Type	Hand	Quantity	Code
T5	Right	5	012679005
T6	Right	5	012679006
T7	Right	5	012679007
T8	Right	5	012679008
T9	Right	5	012679009
T10	Right	5	012679010
T15	Right	5	012679015
T20	Right	5	012679020
T25	Right	5	012679025
T27	Right	5	012679027
T30	Right	5	012679030
T40	Right	2	012679040
T45	Right	2	012679045

1268RTXK



Type	Hand	Quantity	Code
T9	Right	3	012689009
T10	Right	3	012689010
T15	Right	3	012689015
T20	Right	3	012689020
T25	Right	3	012689025
T27	Right	3	012689027
T30	Right	3	012689030
T40	Right	2	012689040

1269PZK



Type	Hand	Quantity	Code
PZ 0	Right	5	012699000
1	Right	5	012699001
2	Right	5	012699002
3	Right	3	012699003
4	Right	3	012699004

1269N/PZK



Type	Hand	Quantity	Code
PZ 1	Right	5	012699011
2	Right	5	012699012

1290K



SxAxL mm		
0,4x2,5x50	5	012909003
0,4x2,5x75	5	012909006
0,5x3x75	10	012909009
0,5x3x100	10	012909012
0,6x3,5x75	10	012909018
0,6x3,5x100	10	012909021
0,8x4x100	10	012909030
0,8x4x125	10	012909033
0,8x4x150	10	012909036
1x5,5x100	10	012909039
1x5,5x150	10	012909042
1,2x6,5x100	10	012909048
1,2x6,5x150	10	012909051
1,2x8x150	3	012909057
1,2x8x200	3	012909060
1,6x10x200	3	012909066

1290NK



SxAxL mm		
0,8x4x30	5	012909103
1,2x6,5x30	5	012909106

1290K/INOX



SxAxL mm		
0,4x2,5x50	4	012909403
0,5x3x75	4	012909409
0,8x4x100	4	012909430
1,0x5,5x150	4	012909442
1,2x6,5x150	4	012909451

1292K



PHxDxL mm		
0x3x60	10	012929003
0x3x100	5	012929006
1x4,5x80	10	012929009
1x4,5x120	10	012929012
2x6x100	10	012929018
2x6x150	10	012929021
3x8x150	3	012929024
4x10x200	3	012929027

1292NK



PHxDxL mm		
1x4,5x30	5	012929103
2x6x30	5	012929106

1292K/INOX



PHxDxL mm		
0x3x60	4	012929403
1x4,5x80	4	012929409
2x6x100	4	012929418

1294K



SxDxL mm		
0,5x2,5x60	5	012949003
0,6x3x75	5	012949006
0,8x4x100	5	012949012
1x5x125	5	012949018

1298RTXK



T9	5	012989009
T10	5	012989010
T15	5	012989015
T20	5	012989020
T25	5	012989025
T27	5	012989027
T30	5	012989030
T40	2	012989040

1299PZK



PZ		
0	5	012999000
1	5	012999003
2	5	012999006

1299N/PZK



PZ		
1	5	012999021
2	5	012999024

1472VW



L mm		
200	1	014720051

1473P



A Max mm		
53	1	014730020

1497RC



1497RC		
	1	014970351

1600Q 8



1600Q 8		
	1	016000008

1600Q 10



1600Q 8		
	1	016000008

1603K



mm2		
0÷8	5	016039001

1603BK



mm ²	0÷8	2	016039010
-----------------	-----	---	-----------

1691BM

CE



L m	5	1	016910205
	8	1	016910208
	10	1	016910210

1692

CE



L m	2	5	016920052
	3	5	016920053
	5	5	016920055
	8	5	016920058

1693

CE



IP54



H mm	100	1	016930020
---------	-----	---	-----------

1729CG



L mm	310	2	017290200
---------	-----	---	-----------

1729DM 450



L mm	450	4	017290450
---------	-----	---	-----------

1741U



Ø mm	2,4	3	3,2	4	4,8
Aluminium	•	•	•	•	•
Steel	•	•	•	•	•
Stainless steel	•	•	•	•	•

1741U	1	017410450
-------	---	-----------

1741B



Ø mm	2,4	3,2	4	4,8	5
Aluminium	•	•	•	•	•
Steel	•	•	•	•	•
Stainless steel	•	•	•	•	•

1741B	1	017410000
-------	---	-----------

1760K

CE



CAT III-1000V



1760K	1	017600140
-------	---	-----------

1762K



Ø mm	2-2,5-3 3,5-4-4,5	2	017629001
---------	----------------------	---	-----------

1771



1771	10	017710000
------	----	-----------

1770BM



L mm	140	10	017700050
---------	-----	----	-----------

1771BM



L mm	170	10	017710050
---------	-----	----	-----------

1771HD



L mm	190	5	017710100
---------	-----	---	-----------

1772R



L mm	125	5	017720006
---------	-----	---	-----------



1773A



L mm 180 10 017730000

1777BMT



L mm 170 5 017770050

1777T



L mm 160 5 017770030

1783



L mm 215 5 017830021
240 5 017830024

1820



1820 30 30W L = 210mm 1 018200003
1820 60 60W L = 220mm 1 018200006
1820 80 80W L = 260mm 1 018200008

1822



1822 120 120W LxA = 250x125 mm 1 018220012
1822 180 180W LxA = 250x125mm 1 018220018
1822 320 320W LxA = 250x140mm 1 018220032

1833S



L mm 150 1 018330002

1833M



L mm 162 1 018330003

1833L



L mm 196 1 018330004

1833XL



L mm 300 1 018330005

1833L/USB



L mm 240 1 018330054

1834RR



1834RR 1 018340520

1836A



1836A 1 018360050

1836B



1836B 1 018360200



1837F



L mm 460 1 018370050

1837F/USB



L mm 460 1 018370060

1838COB



IP65

1838COB 1 018380010

1838P



1838P 1 018380005

1838S



IP65



L mm 260 1 018380122

1838SLIM

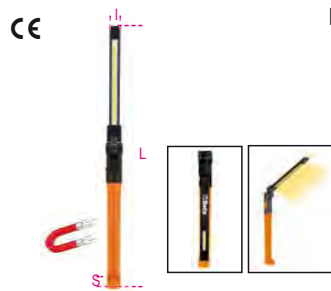

IP54



L mm 307 1 018380221

6888B1/4

blister support for 1/4" sockets



6888B1/4 50 068880900

6888B3/8

blister support for 3/8" sockets



6888B3/8 50 068880910

6888B1/2

blister support for 1/2" sockets



6888B1/2 50 068880920



 **Beta**



DISPLAY UNITS FOR SALES POINTS

Beta
SHOP
in Shop



**BUILD
your Beta corner**

www.beta-tools.com/planner3d/

38/DS1 wall-mounted display with 75 punches



495x260x332 mm

display
with assortment
38/DS1

1 000380701

		n.
30	Ø 2 - 3 - 4 - 5 - 6 mm	5
31	Ø 2 - 3 - 4 - 5 - 6 - 8 - 10 mm	5
32	Ø 3 - 4 - 5 mm	5

empty
display
38/DVS1

1 000380751

38/DS2 wall-mounted display with 65 chisels



495x260x332 mm

display
with assortment
38/DS2

1 000380702

		n.
34	125 - 150 - 175 mm	5
35	100 - 125 - 150 - 200 - 250 - 300 mm	5
36	125 - 150 mm	5
37	150 - 200 mm	5

empty
display
38/DVS2

1 000380752

942BX/DG

wall-mounted display
with 43 hi-torque hexagon nut spinners,
short series



330x260x332 mm

display
with assortment
942BX/DG 1 009420701

942BX	n.
5 - 5,5 mm	3
6 - 7 mm	6
8 - 9 - 10 mm	5
11 mm	2
12 mm	3
13 mm	5

empty
display
942BX/DVG 1 009420751

943BX/DG

wall-mounted display
with 43 hi-torque hexagon nut spinners,
long series



330x260x332 mm

display
with assortment
943BX/DG 1 009430701

943BX	n.
5 - 5,5 mm	3
6 - 7 mm	6
8 - 9 - 10 mm	5
11 mm	2
12 mm	3
13 mm	5

empty
display
943BX/DVG 1 009430751

944BX/DG

wall-mounted display with 43 deep hi-torque
hexagon nut spinners with handles, long
series



330x260x332 mm

display
with assortment
944BX/DG 1 009440701

944BX	n.
5 - 5,5 mm	3
6 - 7 mm	6
8 - 9 - 10 mm	5
11 mm	2
12 mm	3
13 mm	5

empty
display
944BX/DVG 1 009440751

943MQ/BG

wall-mounted display
with 30 hexagon nut spinners



1000 V

330x260x332 mm

display
with assortment
943MQ/BG 1 009430281

943MQ	n.
5,5 - 6 - 7 - 8 - 10 - 13 mm	5

empty
display
943BG-MQ/DV 1 009430285

1203/E1P

wall-mounted display with 82 screwdrivers



495x260x310 mm

display
with assortment
1203E/E1P 1 012031301

1201	n.
0,4x2,5x50 - 0,5x3x75 - 0,6x3,5x100	7
0,8x4x100 - 0,8x4x125 mm	6
1,0x5,5x100 - 1,0x5,5x150 - 1,2x6,5x150 mm	6
1,2x8x150 mm	5
1202	n.
PH0x3x60 mm	7
PH1x4,5x80 - PH2x6x100 mm	6
PH3x8x150 mm	5

empty
display
1203E/EV1P 1 012031351

1203/E4P

wall-mounted display with 85 screwdrivers



495x260x310 mm

display
with assortment
1203E/E4P 1 012031304

1201	n.
0,4x2,5x50 - 0,5x3x75 - 0,8x4x125 mm	7
1,0x5,5x100 - 1,0x5,5x150 - 1,2x6,5x150 mm	6
1204	n.
0,4x2,5x60 - 0,5x3x100 - 0,8x4x100 mm	7
1,0x5x125 mm	6
1209PZ	n.
PZ0x3x60 mm	7
PZ1x4,5x80 - PZ2x6x100 mm	6

empty
display
1203E/EV4P 1 012031354

1203/E5P

wall-mounted display with 82 screwdrivers



495x260x310 mm

display with assortment
1203E/E5P 1 012031305

		n.
+	1202 PH0x3x60 mm	7
	PH1x4,5x80 - PH1x4,5x120	6
	PH2x6x100 - PH2x6x150 mm	5
	PH3x8x150 mm	5
●	1204 0,4x2,5x60 - 0,5x3x100 - 0,8x4x100 mm	7
	1,0x5x125 mm	6
+	1209PZ PZ0x3x60 mm	7
	PZ1x4,5x80 - PZ2x6x100 mm	6

empty display
1203E/EV5P 1 012031355

1203/E10P

wall-mounted display with 80 screwdrivers



495x260x310 mm

display with assortment
1203E/E10P 1 012031310

		n.
+	1207TX T6	4
	T7	3
	T8	7
	T9 - T10 - T15 - T20 - T25	6
	T27 - T30	3
+	1208RTX T9 - T10	3
	T15 - T20 - T25	6
	T27 - T30	3

empty display
1203E/EV10P 1 012031360

1263/E78

wall-mounted display with 78 screwdrivers



495x260x310 mm

display with assortment
1263/E78 1 012630510

●	1260 2,5x75-3x75-3,5x100 mm	7
	4x100-4x125-5,5x100-5,5x150-6,5x150 mm	6
	8x150 mm	4
+	1262 PH0x60 mm	7
	PH1x80-PH2x100 mm	6
	PH3x150	4

empty display
1263/EV78 1 012630511

1263/E74

wall-mounted display with 74 screwdrivers



495x260x310 mm

display with assortment
1263/E74 1 012630540

●	1264 2,5x60 mm	7
	3x75 mm	3
	3x100 - 4x100 mm	4
	4x125 - 5x150 mm	2
	5x125 - 6,5x150 mm	4
+	1262 PH 8x150	3
	PH 3x60 - 3x100 mm	7
	PH 4,5x80 - 4,5x120 mm	6
	PH 6x100 mm	10
	PH 6x150 mm	5

empty display
1263/EV74 1 012630541

1263/E85

wall-mounted display with 85 screwdrivers



495x260x377 mm

display with assortment
1263/E85 1 012630550

		n.
●	1260 2,5x50 mm	7
	2,5x75 mm	6
	3x75 - 3x100 - 3,5x100 mm	7
	4x100 - 4x125 - 5,5x125	6
	5,5x150 - 6,5x150 mm	4
	8x150 mm	4
●	1260E 10x200 mm	3
	12x250 mm	2
	4x30 - 6,5x30 mm	6

empty display
1263/EV85 1 012630551

1263/E70

wall-mounted display with 70 screwdrivers



495x260x327 mm

display with assortment
1263/E70 1 012630560

		n.
+	1262 PH0x60 - PH0x100 mm	7
	PH1x80 - PH1x120 mm	6
	PH2x100 mm	9
	PH2x150 - PH3x150 mm	5
	PH4x200 mm	4
+	1262E PH2x150 mm	5
	PH3x175 mm	4
+	1262N PH1x30 - PH2x30 mm	6

empty display
1263/EV70 1 012630561

1263/E50

wall-mounted display
with 50 screwdrivers



330x260x269 mm

display
with assortment
1263/E50

1 012630570

	n.
● 1264 2,5x60 - 3x75 - 3x100 mm	7
4x100 - 4x125 - 5x125 - 5x150 mm	6
6,5x150 mm	5

empty
display
1263/EV50

1 012630571

1263/E62

wall-mounted display
with 62 screwdrivers



495x260x257 mm

display
with assortment
1263/E62

1 012630590

	n.
● 1267TX T5	5
T6	6
T7	5
T8	6
T9	5
T10 - T15 - T20	6
T25	5
T27 - T30	4
T40 - T45	2

empty
display
1263/EV62

1 012630591

1263/E39

wall-mounted display
with 39 screwdrivers



330x260x257 mm

display
with assortment
1263/E39

1 012630595

	n.
⊕ 1268RTX T9x60 - T10x80 - T15x80 T20x100 - T25x100 mm T27x115 mm	6
T30x115 mm	3
T40x130 mm	2

empty
display
1263/EV39

1 012630596

1263/E40

wall-mounted display
with 40 screwdrivers



330x260x327 mm

display
with assortment
1263/E40

1 012630580

	n.
⊕ 1269 PZ0x60 mm PZ1x80 mm	7
PZ2x100 - PZ3x150 - PZ4x200 mm	5
⊕ 1269N PZ1x30 - PZ2x30 mm	6

empty
display
1263/EV40

1 012630581

1273MQ/E1

wall-mounted display with 40 screwdrivers



△ 1000 V

330x260x332 mm

display
with assortment
1273MQ/E1

1 012730312

	n.
⊕ 1272MQ PH0x60 - PH1x80 mm PH2x100 mm PH3x150 mm	5
● 1274MQ 3x100 - 4x100 - 5,5x125 - 6,5x150 mm 8x175 mm 10x200 mm	5
	3
	2

empty
display
1273BG-MQ/DV

1 012730651

1273MQ/E2

wall-mounted display
with 43 screwdrivers



△ 1000 V

330x260x332 mm

display
with assortment
1273MQ/E2

1 012730313

	n.
⊕ 1272MQ/F 4,5x80 - 6x100 mm	3
● 1274MQ/F 3,5x100 - 4,5x100 - 5,5x125 - 6,5x150 mm	3
⊕ 1275MQ/C 4,5x80 - 6x100 mm	5
⊕ 1276MQ/C 4,5x80 - 6x100 mm	5
● 1279MQ/F 4,5x80 6x100	3
	2

empty
display
1273BG-MQ/DV-2

1 012730653

1293BX/DA

wall-mounted display with 90 screwdrivers



495x260x332 mm

display with assortment
1293BX/DA 1 012930701

		n.
● 1290	3x75 - 3,5x100 - 4x100 - 4x125 5,5x100 - 5,5x150 mm 6,5x150 mm 8x150 mm 10x200 mm	7 6 3 2
● 1290N	4x30 - 6,5x30 mm	3
⊕ 1292	PH0x60 - PH1x80 mm PH2x100 mm PH3x150 mm	7 6 5
⊕ 1292N	PH1x30 - PH2x30 mm	3

empty display
1293BX/DVA 1 012930751

1293BX/DD

wall-mounted display with 48 screwdrivers



330x260x332 mm

display with assortment
1293BX/DD 1 012930704

		n.
● 1294	2,5x60 - 3x75 - 3x100 - 4x100 4x150 - 5x125 mm 6,5x150 mm	7 6

empty display
1293BX/DVD 1 012930754

1293BX/DE

wall-mounted display with 42 screwdrivers



330x260x332 mm

display with assortment
1293BX/DE 1 012930705

		n.
⊕ 1299PZ	PZ0x60 - PZ1x80 mm PZ2x100 mm PZ3x150 - PZ4x200 mm	7 6 5
⊕ 1299N/PZ	PZ1x30 - PZ2x30 mm	6

empty display
1293BX/DVE 1 012930755

1293BX/DF

wall-mounted display with 59 screwdrivers



330x260x332 mm

display with assortment
1293BX/DF 1 012930706

		n.
⊕ 1297TX	T6 - T8 - T10 - T15 - T20 - T25 T27 - T30 T40	7 6 5

empty display
1293BX/DVF 1 012930756

C68

Beta wall display, empty



1000x560x2200 mm

C68/1	1 m	1 068000001
C68/2	2 m	1 068000002
C68/3	3 m	1 068000003
C68/4	4 m	1 068000004
C68/5	5 m	1 068000005
C68/6	6 m	1 068000006
C68/7	7 m	1 068000007
C68/8	8 m	1 068000008
C68/9	9 m	1 068000009
C68/10	10 m	1 068000010

C68 G

"gondola" display



1000x1120x1600 mm

C68G/1	1 m	1 068000051
C68G/2	2 m	1 068000052
C68G/3	3 m	1 068000053
C68G/4	4 m	1 068000054

C88 R/1

Robur wall display, empty



1000x560x2200 mm

C88R/1 1 m

1 08800001

C88VE

display tray for display walls C88

suitable for housing coils of chains item 8120



C88VE

1 088000120

C88SE

display tray for Genovese chain reels



C88SE

1 088000130

1700x600x600 mm

6888

hooks for displays C60 - C61 - C68 - C88



6888S1	10	068880011
6888S2	10	068880012
6888D1	5	068880021
6888D2	5	068880022
6888D4	5	068880024
6888D5	5	068880025
6888T1	5	068880031
6888T2	5	068880032
6888CT	1	068880044
6888B	1	068880100
6888GA	3	068880120
6888S-1/4	1	068880605
6888S-3/8	1	068880610

6800 VE

showcase for wall displays C68 and C68 R/1



6800VE/1	1 m	1	068000401
6800VE/2	2 m	1	068000402
6800VE/3	3 m	1	068000403
6800VE/4	4 m	1	068000404
6800VE/5	5 m	1	068000405

Beta

ACCESSORIES



6800AE	1	068000145
6800AI	1	068000140
6800AD/P	1	068000143

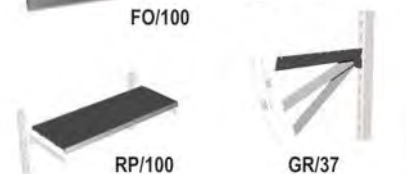
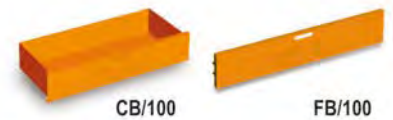

6800CB/100	1	068000104
6800FB/100	1	068000109
6800FO/100	1	068000108
6800PL	1	068000137
6800RP/100	1	068000150
6800GR/37	1	068000159

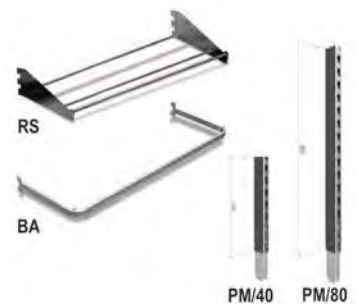

6800BA	1	068000130
6800RS	1	068000135
6800PM/40	1	068000171
6800PM/80	1	068000172

Beta

6600 M/14

assortment of 154 tools,
with hooks without panel



6600 M/14

1 066000014

6600 M/22

assortment of 108 tools,
with hooks without panel



6600 M/22

1 066000022

6600 M/27

assortment of 25 tools,
with hooks without panel



6600 M/27

1 066000027

6600 M/29

assortment of 173 tools,
with hooks without panel

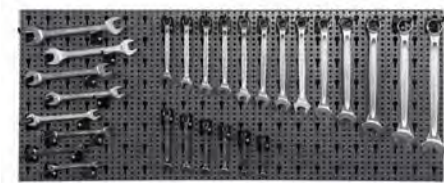

6600 M/29

1 066000029

6600 M/33

assortment of 37 tools, with hooks without panel



6600 M/33

1 066000033

6600 M/40

assortment of 100 tools,
with hooks without panel



6600 M/40

1 066000040

6600 M/42

assortment of 65 tools,
with hooks without panel



6600 M/42

1 066000042

6600 M/44

assortment of 48 tools,
with hooks without panel

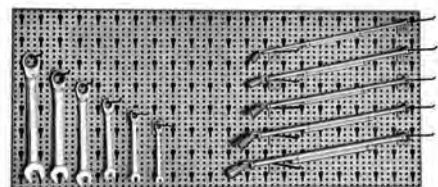

6600 M/44

1 066000044

6600 M/47

assortment of 65 tools,
with hooks without panel



6600 M/47

1 066000047

6600 M/51

assortment of 257 tools
with hooks without panel



6600 M/51

1 066000051

6600 M/52

assortment of 176 tools
with hooks without panel



6600 M/52

1 066000052

6600 M/58

assortment of 150 tools
with hooks without panel



6600 M/58

1 066000058

6600 M/59

assortment of 220 tools,
with hooks without panel



6600 M/59

1 066000059

6600 M/61

assortment of 71 tools,
with hooks without panel



6600 M/61

1 066000061

6600 M/62

assortment of 28 tools,
with hooks without panel



6600 M/62

1 066000062

6600 M/63

assortment of 110 tools
with hooks without panel

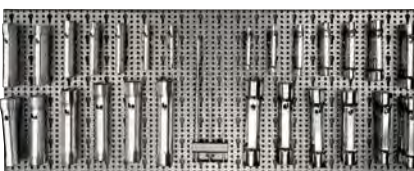

6600 M/63

1 066000063

6600 M/73

assortment of 68 tools
with hooks without panel



6600 M/73

1 066000073

6600 M/112

assortment of 329 tools,
with hooks without panel



6600 M/112

1 066000112

6600 M/116

assortment of 306 tools,
with hooks without panel



6600 M/116

1 066000116

6600 M/120

assortment of 163 tools,
with hooks without panel



6600 M/120

1 066000120

6600 M/125

assortment of 133 tools,
with hooks without panel



6600 M/125

1 066000125

6600 M/126

assortment of 58 tools,
with hooks without panel



6600 M/126

1 066000126

6600 M/131

assortment of 92 tools,
with hooks without panel



6600 M/131

1 066000131

6600 M/174

assortment of 13 tools, with hooks without
panel



6600 M/174

1 066000174

6600 M/175

assortment of 12 tools,
with hooks without panel



6600 M/175 1 066000175

6600 M/217

assortment of 74 tools,
with hooks without panel

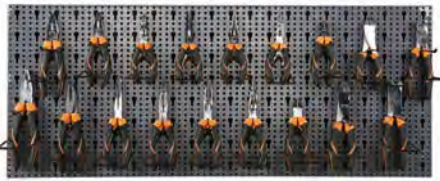

6600 M/217 1 066000217

6600 M/218

assortment of 58 tools,
with hooks without panel



6600 M/218 1 066000218

6600 M/222

assortment of 74 tools,
with hooks without panel

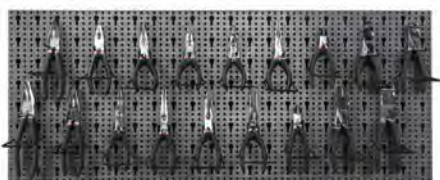

6600 M/222 1 066000222

6600 M/223

assortment of 58 tools,
with hooks without panel



6600 M/223 1 066000223

6600 M/230

assortment of 78 tools,
with hooks without panel



6600 M/230 1 066000230

6600 M/236

assortment of 31 tools,
with hooks without panel



6600 M/236 1 066000236

6600 M/241

assortment of 43 tools,
with hooks without panel



6600 M/241 1 066000241

6600 M/242

assortment of 91 tools,
with hooks without panel



6600 M/242 1 066000242

6600 M/253

assortment of 60 tools,
with hooks without panel



6600 M/253 1 066000253

6600 M/311

assortment of 114 tools,
with hooks without panel



6600 M/311 1 066000311

6600 M/315

assortment of 149 tools,
with hooks without panel



6600 M/315 1 066000315

6600 M/320

assortment of 98 tools,
with hooks without panel



6600 M/320



6600 M/326

assortment of 155 tools,
with hooks without panel



6600 M/326



6600 M/327

assortment of 101 tools,
with hooks without panel



6600 M/327



6600 M/330

assortment of 110 tools,
with hooks without panel



6600 M/330



6600 M/371

assortment of 162 tools,
with hooks without panel



6600 M/371



6600 M/379

assortment of 69 tools,
with hooks without panel



6600 M/379



6600 M/406

assortment of 107 tools,
with hooks without panel



6600 M/406



6600 M/417

assortment of 43 tools,
with hooks without panel



6600 M/417



6600 M/423

assortment of 30 tools, with hooks without panel



6600 M/423



6600 M/424

assortment of 36 tools, with hooks without panel



6600 M/424



6600 M/427

assortment of 24 tools,
with hooks without panel



6600 M/427



6600 M/430

assortment of 29 tools,
with hooks without panel





6600 M/430

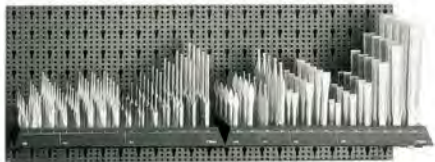

6600 M/440

assortment of 140 tools,
with hooks without panel





6600 M/440  1  066000440

6600 M/456

assortment of 41 tools,
with hooks without panel





6600 M/456  1  066000456

6600 M/465

assortment of 36 tools, with hooks without
panel





6600 M/465  1  066000465

6600 M/480

assortment of 18 tools,
with hooks without panel





6600 M/480  1  066000480

6600 M/485

assortment of 12 tools,
with hooks without panel





6600 M/485  1  066000485

6600 M/510

assortment of 16 tools,
with hooks without panel





6600 M/510  1  066000510

6600 M/532

assortment of 24 tools
with hooks without panel





6600 M/532  1  066000532

6600 M/534

assortment of 51 tools,
with hooks without panel





6600 M/534  1  066000534

6600 M/542

assortment of 53 tools,
with hooks without panel



6600 M/542  1  066000542

6600 M/548

assortment of 37 tools,
with hooks without panel





6600 M/548  1  066000548

6600 M/561

assortment of 60 tools,
with hooks without panel





6600 M/561  1  066000561

6600 M/583

assortment of 22 tools
with hooks without panel



6600 M/583  1  066000583

6600 M/640

assortment of 90 tools, with hooks without panel



6600 M/640



6600 M/716

assortment of 64 tools, with hooks without panel



6600 M/716



6600 M/856

assortment of 560 hard abrasive discs, with hooks without panel



6600 M/856



6600 M/650

assortment of 28 tools, with hooks without panel



6600 M/650



6600 M/813

assortment of 25 tools, with hooks without panel



6600 M/813



6600 M/857

assortment of 560 hard abrasive discs, with hooks without panel



6600 M/857



6600 M/657

assortment of 17 tools, with hooks without panel



6600 M/657



6600 M/842

assortment of 36 tools, with hooks without panel



6600 M/842



6600 M/871

assortment of 120 abrasives with hooks without panel



6600 M/871



6600 M/658

assortment of 14 tools with hooks without panel



6600 M/658



6600 M/852

assortment of 560 hard abrasive discs, with hooks without panel



6600 M/852



6600 M/878

assortment of 100 abrasives with hooks without panel



6600 M/878



6600 M/881

assortment of 410 abrasives
with display tray



6600 M/881 1 066000881



8600 R/11

assortment of 374 wire rope accessories, with
hooks without panel



8600 R/11 1 086000011

8600 R/12

assortment of 259 wire rope accessories,
with hooks without panel

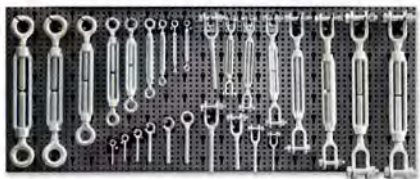

8600 R/12 1 086000012

8600 R/13

assortment of 230 wire rope accessories,
with hooks without panel



8600 R/13 1 086000013

8600 R/113

assortment of 1862 wire rope accessories,
with hooks without panel



8600 R/113 1 086000113

8600 R/114

assortment of 1045 wire rope accessories,
with hooks without panel



8600 R/114 1 086000114

8600 R/225

assortment of 64 GRADE 8 accessories,
with hooks without panel

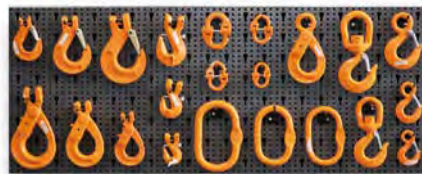

8600 R/225 1 086000225

8600 R/412

assortment of 348 STAINLESS STEEL wire
rope accessories,
with hooks without panel

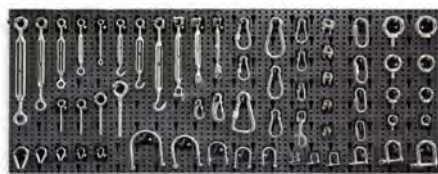

8600 R/412 1 086000412

8600 R/511

assortment of 11 Genovese chain reels,
with display tray



8600 R/511 1 086000511

8600 R/601

assortment of 50 tie down ratchets
with grids, shelf and hooks,
without panel



8600 R/601
C88/R601 1 086000601
1 088000160

8600 R/611

assortment of 52 webslings
with grids, without panel



8600 R/611
C88/R611 1 086000611
1 088000161





SAFETY FOOTWEAR

STANDARDS AND CLASSES

WARNINGS

Before use make, sure that the footwear meets your use requirements and has a proper protection class, according to type and workplace. The footwear manufactured by Beta Utensili complies with current EUROPEAN STANDARDS. The employer shall ensure that suitable personal protective equipment is provided to the employees who may be exposed to a risk (characteristics and category of PPE).

EUROPEAN STANDARDS AND MEANINGS

COMPLIANCE WITH EN ISO 20344:2011

This standard specifies the test methods for footwear designed as PPE.

COMPLIANCE WITH EN ISO 20345:2011

This standard specifies basic and additional (optional) requirements for **Safety Footwear** for general purpose. Footwear according to EN ISO 20345:2011 is marked “**S**” (= Safety), with toe caps resistant to an impact of 200 Joules.

COMPLIANCE WITH EN ISO 20346:2014

This standard specifies basic and additional (optional) requirements for **Protective Footwear**. Footwear according to EN ISO 20346:2011 is marked “**P**” (=Protective), with toe caps resistant to an impact of 100 Joules.

COMPLIANCE WITH EN ISO 20347:2012

This standard specifies basic and additional (optional) requirements for **occupational footwear that is not exposed to any mechanical risks** (impact or compression). Footwear according to EN ISO 20347:2012 is marked “**O**” (= Occupational). It shares quite the same characteristics as the above footwear, although neither toe caps nor penetration-proof insoles are required.

As well as the basic requirements under EN ISO 20345:2011, footwear may also meet some **additional requirements**, which must be identified with symbols or classes and stated on the label applied to the tongue of the footwear.

CONFORMITY MARKING OF FOOTWEAR

- Mark: CE
- Footwear size: 42
- Name and address of manufacturer: Beta Utensili S.p.A. Via Volta, 18 20845 Sovico (MB) – Italy
- Date of production (month/year): 01/20
- Reference to international standard: EN ISO 20345:2011
- Protection class: S3

CLASSIFICATION

I = Footwear made from leather and other materials, excluding rubber or polymeric footwear
II = All-rubber or all-polymeric footwear (boots)

CLASS AND REQUIREMENTS

SB (I) Basic requirements

- Toe cap resistant to an **impact** of 200 Joules
- Outsole **slip** resistance (SRA and/or SRB)
- Minimum upper **height**
- One additional footwear requirement

S1 (I) Basic requirements plus:

- Closed **seat** region
- **Antistatic** properties (A)
- **Energy absorption** of seat region (E)

S2 (I) S1 requirements plus:

- Water penetration and **water absorption** resistant upper (WRU)

S3 (I) S2 requirements plus:

- **Penetration** resistance (P)
- **Cleated** outsole

S4 (II) SB requirements plus:

- **Antistatic** properties (A)
- **Energy absorption** of seat region (E)

S5 (II) S4 requirements plus:

- **Penetration** resistance (P)
- **Cleated** outsole

BASIC REQUIREMENTS + ADDITIONAL REQUIREMENTS FOR FOOTWEAR

PROTECTION CLASS		EN ISO 20345:2011				EN ISO 20347:2012				EN ISO 20345:2011		EN ISO 20347:2012		MINIMUM REQUIRED VALUES
		SB	S1	S2	S3	OB	O1	O2	O3	S4	S5	O4	O5	
	Closed seat region	O	X	X	X	O	X	X	X	X	X	X	X	
	Toe cap resistant to an impact of 200 Joules	X	X	X	X	-	-	-	-	X	X	-	-	
A	Antistatic footwear	O	X	X	X	O	X	X	X	X	X	X	X	Electrical resistance >100 kΩ, ≤1000 MΩ
E	Energy absorption of seat region	O	X	X	X	O	X	X	X	X	X	X	X	> 20 Joules
WRU	Water penetration and resistance of upper	O	-	X	X	O	-	X	X	-	-	-	-	Penetration: <0.2 g x 60 min Absorption: < 30% x 60 min.
P	Penetration resistance of outsole	O	O	-	X	O	O	-	X	O	X	O	X	> 1100 N
CI	Cold insulation	O	O	O	O	O	O	O	O	O	O	O	O	Temp. decrease of inner surface of sole: < 10° C
HI	Heat insulation	O	O	O	O	O	O	O	O	O	O	O	O	Temp. increase of inner surface of sole: < 22° C
C	Conductive footwear	O	-	-	-	O	-	-	-	-	-	-	-	< 100 kΩ
HRO	Heat resistance of outsole	O	O	O	O	O	O	O	O	O	O	O	O	Resistant up to 300°
AN	Ankle protection	O	O	O	O	O	O	O	O	O	O	O	O	Mean value <10 kN; Individual values <15 kN
I	Electrically insulating footwear	O	-	-	-	O	-	-	-	-	-	-	-	Electrical class: 00 ÷ 500 V a.c. Electrical class: 0 ÷ 1000 V a.
WR	Water resistance	O	O	O	O	O	O	O	O	-	-	-	-	Absorption: < 3 cm ²
M	Metatarsal protection (only for EN ISO 20345:2011)	O	O	O	O	-	-	-	-	O	O	-	-	Free height after impact ≥ 40 mm. (size 41/42)
CR	Cut resistance of upper (only for EN ISO 20345:2011) (other than model A)	O	O	O	O	-	-	-	-	O	O	-	-	Cut resistance index ≥ 2,5
FO	Fuel oil resistance of outsole	O	X	X	X	O	O	O	O	X	X	O	O	Outsole volume increase < 12%
WG	Protection against molten metal splashes as found in foundries and welding	-	-	-	-	-	-	-	-	-	-	-	-	Min. 25 drops to get to a temperature of 40° C
SRC	Slip resistance of outsole	X	X	X	X	X	X	X	X					SRA + SRB requirement

X	Mandatory requirement for protection class
O	Optional requirement added to mandatory ones, if marked on marking
-	Not mandatory requirement, check footwear stamping

Antistatic footwear:

Antistatic footwear must be used when there is the need to minimize the accumulation of electrostatic charges, so as to rule out the danger of combustion of flammable substances and vapours and in case the risk of electric shocks from live parts should persist. Antistatic footwear does not provide protection against electric shock, as it only creates an electrical resistance between the floor and the foot. If the danger of electric shock cannot be completely ruled out, additional precautions must be taken as part of a periodic plan for accident prevention in the workplace. For antistatic requirements to be met, the footwear must not be modified.

Insulating footwear:

Insulating footwear provide electrical protection against accidental contacts with voltages up to 1000 V, provided that usage conditions are such as not to modify or alter electrical resistance under the influence of humidity. It should be pointed out that electrical resistance

only refers to the bottom, and not to the upper, of the footwear.

Electrical classes for footwear:

Class 00 500V CA or 750V CC

Class 0 1000V CA or 1500V CC

Dissipative footwear for EPA environments:

Dissipative footwear, which is specially designed for EPA (ESDS) environments, allows electrostatic charges to be dissipated from the wearer's body in a continuous and controlled way, so as to protect electronic components and devices from electrostatic phenomena. The reference value of ground resistance according to CEI EN 61340-5-1: 2016, for wearer/footwear/floor, is <1 × 10⁹ Ω.

EN ISO 20345:2011 S1P SRC

LINE	ITEM	REQUIREMENTS			RECOMMENDED SECTORS						
		ADDITIONAL REQUIREMENTS			AUTOMOTIVE	BUILDING	ELECTRICITY	INDUSTRY	SERVICE LOGISTICS	EATING & PLUMBING	
BASIC PLUS 	7210BKK			X	X	X	X	X	X	X	564
	7216BKK			X	X	X	X	X	X	X	565
FLEX 	7212FG			X	X		X	X	X	X	561
	7213FG			X	X		X	X	X	X	562
FLEX LADY 	7212LG			X	X		X	X	X	X	561
FLEX EVOLUTION 	7217FB			X	X		X	X	X	X	563
	7217FG			X	X		X	X	X	X	563
EASY PLUS 	7223PEK			X	X	X	X	X	X	X	560
	7224PEK			X	X	X	X	X	X	X	561
BASIC 	7241BK				X	X	X	X	X		557
	7243BK				X	X	X		X		557
	7246BK				X	X	X	X	X		559
	7247BK				X	X	X	X	X		559
EASY 	7246E					X	X	X	X		556
TREKKING 	7248GK					X	X	X	X		566
	7249GK	RS				X	X		X		566
SNEAKERS 	7314AB			X	X	X	X	X	X	X	568
	7314AF			X	X	X	X	X	X	X	567
	7317NA			X	X	X	X	X	X	X	568
SNEAKERS PRO 	7340B				X		X	X	X		572
	7340R				X		X	X	X		572
MANAGER 	7319ESD	ESD	X	X	X		X	X			574
0-GRAVITY 	7352A	HRO		X	X		X	X	X	X	570
	7352B	HRO		X	X		X	X	X	X	570
	7353Y	HRO		X	X		X	X	X	X	570

EN ISO 20347:2012 O1 SRC

LINE	ITEM	REQUIREMENTS	RECOMMENDED SECTORS							
0-GRAVITY 	7362B	FO HRO	X	X	X	X				571



EN ISO 20345:2011 S3 SRC

LINE	ITEM	REQUIREMENTS			RECOMMENDED SECTORS								
		ADDITIONAL REQUIREMENTS			AGRICULTURE	AUTOMOTIVE	BUILDING	INDUSTRY	ELECTRICITY	SERVICE LOGISTICS	OIL & GAS		EATING & PLUMBING
BASIC PLUS 	7200BKK			X	X	X	X	X	X	X	X	X	564
	7201BKK			X	X	X	X	X	X	X	X	X	564
	7310CRK	RS HRO			X	X	X	X			X		565
FLEX 	7214FN			X	X		X	X	X	X		X	562
	7215FN			X	X		X	X	X	X		X	562
	7218FN	RS			X	X		X	X	X		X	563
FLEX LADY 	7214LN			X	X		X	X	X		X	562	
FLEX EVOLUTION 	7219FY			X	X		X	X	X		X	563	
EASY PLUS 	7220PEK			X	X	X	X	X	X	X		X	560
	7221PEK	RS			X	X	X	X	X	X		X	560
TREKKING 	7235BK				X	X	X		X		X		565
	7236BK	RS			X	X	X				X		566
	7238WR	RS HRO WR			X	X	X				X		566
EASY 	7241EN				X	X	X		X		X		556
	7243EN	RS			X	X	X				X		556
BASIC 	7241CK				X	X	X	X		X		X	557
	7243CK	RS			X	X	X	X			X		558
	7243CR	RS HRO			X	X	X			X	X		558
	7245BK	RS			X	X	X	X			X		558
SNEAKERS 	7252NKK			X	X	X	X	X	X	X		X	567
	7253NKK			X	X	X	X	X	X	X		X	567
HEAVY DUTY 	7293HM	HRO HI	X		X	X				X	X		574
	7293HN	HRO HI	X		X	X				X	X		575
	7294HM	HRO HI	X		X	X				X	X		575
	7294HMC	HRO HI CI WR	X		X	X				X	X		575
	7294HN	RS HRO HI	X		X	X				X	X		575
MANAGER 	7300MK		X	X	X	X	X	X	X	X			573
SNEAKERS 	7315AN		X		X	X	X	X	X	X		X	569
	7318AN		X		X	X	X	X	X	X		X	569
	7320NA		X	X	X	X	X	X	X	X		X	568
	7321NA	RS	X	X	X	X	X	X	X	X		X	568
SNEAKERS PRO 	7341N				X	X		X		X		X	572
	7349RP	HRO	X		X	X	X	X	X	X		X	573
	7350RP	HRO	X		X	X	X	X	X	X		X	573
0-GRAVITY 	7354N	HRO	X		X	X	X	X	X	X		X	571
	7355V	HRO	X		X	X	X	X	X	X		X	571
	7356G	HRO	X		X	X	X	X	X	X		X	569
	7357G	HRO	X		X	X	X	X	X	X		X	570

EN ISO 20347:2012 O2 SRC

LINE	ITEM	REQUIREMENTS	RECOMMENDED SECTORS								
BASIC 	7243FT	FO	X	X	X					X	558
MANAGER 	7300FT	FO	X	X	X	X	X				574
0-GRAVITY 	7363N	FO HRO	X		X	X	X				571

EN ISO 20345:2011 S5 SRC

LINE	ITEM	REQUIREMENTS	RECOMMENDED SECTORS								
BASIC 	7328EA		X	X	X				X	X	559
	7328EN		X	X	X				X	X	559

EASY



7241EN
leather shoe, water-repellent

- Steel toe cap
- Elastic steel penetration proof insole

EU	UK		
35	2,5	1	072410835
36	3,5	1	072410836
37	4,5	1	072410837
38	5	1	072410838
39	6	1	072410839
40	6,5	1	072410840
41	7	1	072410841
42	8	1	072410842
43	9	1	072410843
44	10	1	072410844
45	10,5	1	072410845
46	11	1	072410846
47	12	1	072410847
48	13	1	072410848



CE

S3 SRC

**EN ISO
20345
2011**



7243EN
leather ankle shoe, water-repellent,
with quick opening system

- Steel toe cap
- Elastic steel penetration proof insole

EU	UK		
35	2,5	1	072430835
36	3,5	1	072430836
37	4,5	1	072430837
38	5	1	072430838
39	6	1	072430839
40	6,5	1	072430840
41	7	1	072430841
42	8	1	072430842
43	9	1	072430843
44	10	1	072430844
45	10,5	1	072430845
46	11	1	072430846
47	12	1	072430847
48	13	1	072430848



CE

S3 RS SRC

**EN ISO
20345
2011**



7246E
suede shoe, perforated

- Steel toe cap
- Elastic steel penetration proof insole

EU	UK		
35	2,5	1	072460435
36	3,5	1	072460436
37	4,5	1	072460437
38	5	1	072460438
39	6	1	072460439
40	6,5	1	072460440
41	7	1	072460441
42	8	1	072460442
43	9	1	072460443
44	10	1	072460444
45	10,5	1	072460445
46	11	1	072460446
47	12	1	072460447
48	13	1	072460448



CE

S1P SRC

**EN ISO
20345
2011**



BASIC



7241BK
leather shoe

- Steel toe cap
- Composite fibre penetration proof insole

**EN ISO
20345
2011**



EU	UK	
35	2,5	1 072411235
36	3,5	1 072411236
37	4,5	1 072411237
38	5	1 072411238
39	6	1 072411239
40	6,5	1 072411240
41	7	1 072411241
42	8	1 072411242
43	9	1 072411243
44	10	1 072411244
45	10,5	1 072411245
46	11	1 072411246
47	12	1 072411247
48	13	1 072411248



CE

S1P SRC

7241CK
leather shoe, water-repellent

- Steel toe cap
- Composite fibre penetration proof insole

**EN ISO
20345
2011**



EU	UK	
35	2,5	1 072411535
36	3,5	1 072411536
37	4,5	1 072411537
38	5	1 072411538
39	6	1 072411539
40	6,5	1 072411540
41	7	1 072411541
42	8	1 072411542
43	9	1 072411543
44	10	1 072411544
45	10,5	1 072411545
46	11	1 072411546
47	12	1 072411547
48	13	1 072411548



CE

S3 SRC

7243BK
leather ankle shoe

- Steel toe cap
- Composite fibre penetration proof insole

**EN ISO
20345
2011**



EU	UK	
35	2,5	1 072431235
36	3,5	1 072431236
37	4,5	1 072431237
38	5	1 072431238
39	6	1 072431239
40	6,5	1 072431240
41	7	1 072431241
42	8	1 072431242
43	9	1 072431243
44	10	1 072431244
45	10,5	1 072431245
46	11	1 072431246
47	12	1 072431247
48	13	1 072431248



CE

S1P SRC

7243CK

leather ankle shoe, water-repellent, with quick opening system

- Steel toe cap
- Composite fibre penetration proof insole

EU	UK	
35	2,5	1 072431335
36	3,5	1 072431336
37	4,5	1 072431337
38	5	1 072431338
39	6	1 072431339
40	6,5	1 072431340
41	7	1 072431341
42	8	1 072431342
43	9	1 072431343
44	10	1 072431344
45	10,5	1 072431345
46	11	1 072431346
47	12	1 072431347
48	13	1 072431348



CE

S3 RS SRC



7243CR

leather ankle shoe, waterproof, with durable rubber outsole and quick opening system

- Steel toe cap
- Elastic steel penetration-proof insole

EU	UK	
35	2,5	1 072430735
36	3,5	1 072430736
37	4,5	1 072430737
38	5	1 072430738
39	6	1 072430739
40	6,5	1 072430740
41	7	1 072430741
42	8	1 072430742
43	9	1 072430743
44	10	1 072430744
45	10,5	1 072430745
46	11	1 072430746
47	12	1 072430747
48	13	1 072430748



CE

S3 RS HRO SRC



7243FT

leather ankle shoe, waterproof, without toe cap and penetration proof insole

- Without toe cap
- Without penetration proof insole

EU	UK	
35	2,5	1 072430635
36	3,5	1 072430636
37	4,5	1 072430637
38	5	1 072430638
39	6	1 072430639
40	6,5	1 072430640
41	7	1 072430641
42	8	1 072430642
43	9	1 072430643
44	10	1 072430644
45	10,5	1 072430645
46	11	1 072430646
47	12	1 072430647
48	13	1 072430648



CE

O2 FO SRC



7245BK

lace-up leather ankle shoe, "welder" style, water-repellent, with quick opening system and front protection with strap closure

- Steel toe cap
- Composite fibre penetration proof insole

EU	UK	
35	2,5	1 072451235
36	3,5	1 072451236
37	4,5	1 072451237
38	5	1 072451238
39	6	1 072451239
40	6,5	1 072451240
41	7	1 072451241
42	8	1 072451242
43	9	1 072451243
44	10	1 072451244
45	10,5	1 072451245
46	11	1 072451246
47	12	1 072451247
48	13	1 072451248



CE

S3 RS SRC



7246BK
suede shoe, perforated

- Steel toe cap
- Composite fibre penetration proof insole

EU	UK		
35	2,5	1	072461235
36	3,5	1	072461236
37	4,5	1	072461237
38	5	1	072461238
39	6	1	072461239
40	6,5	1	072461240
41	7	1	072461241
42	8	1	072461242
43	9	1	072461243
44	10	1	072461244
45	10,5	1	072461245
46	11	1	072461246
47	12	1	072461247
48	13	1	072461248

CE



S1P SRC



7247BK
leather sandal, perforated

- Steel toe cap
- Composite fibre penetration proof insole

EU	UK		
35	2,5	1	072471235
36	3,5	1	072471236
37	4,5	1	072471237
38	5	1	072471238
39	6	1	072471239
40	6,5	1	072471240
41	7	1	072471241
42	8	1	072471242
43	9	1	072471243
44	10	1	072471244
45	10,5	1	072471245
46	11	1	072471246
47	12	1	072471247
48	13	1	072471248

CE



S1P SRC



7328EA
safety boot, "Top Visibility"

- Steel toe cap
- Stainless steel penetration proof insole

EU	UK		
38	5	1	073280538
39	6	1	073280539
40	6,5	1	073280540
41	7	1	073280541
42	8	1	073280542
43	9	1	073280543
44	10	1	073280544
45	10,5	1	073280545
46	11	1	073280546
47	12	1	073280547

CE



S5 SRC



7328EN
safety boot

- Steel toe cap
- Stainless steel penetration proof insole

EU	UK		
38	5	1	073280738
39	6	1	073280739
40	6,5	1	073280740
41	7	1	073280741
42	8	1	073280742
43	9	1	073280743
44	10	1	073280744
45	10,5	1	073280745
46	11	1	073280746
47	12	1	073280747

CE



S5 SRC



EASY PLUS



7220PEK

leather shoe, water-repellent, with nylon inserts and anti-abrasion reinforcement in toe cap area

- Composite toe cap
- Composite fibre penetration proof insole

EU	UK		
35	2,5	1	072200235
36	3,5	1	072200236
37	4,5	1	072200237
38	5	1	072200238
39	6	1	072200239
40	6,5	1	072200240
41	7	1	072200241
42	8	1	072200242
43	9	1	072200243
44	10	1	072200244
45	10,5	1	072200245
46	11	1	072200246
47	12	1	072200247
48	13	1	072200248



**EN ISO
20345
2011**



CE

S3 SRC

7221PEK

leather ankle shoe, water-repellent, with nylon inserts, anti-abrasion reinforcement in toe cap area and quick opening system

- Composite toe cap
- Composite fibre penetration proof insole

EU	UK		
35	2,5	1	072210235
36	3,5	1	072210236
37	4,5	1	072210237
38	5	1	072210238
39	6	1	072210239
40	6,5	1	072210240
41	7	1	072210241
42	8	1	072210242
43	9	1	072210243
44	10	1	072210244
45	10,5	1	072210245
46	11	1	072210246
47	12	1	072210247
48	13	1	072210248



**EN ISO
20345
2011**



CE

S3 RS SRC

7223PEK

suede shoe with highly breathable mesh inserts and anti-abrasion reinforcement in toe cap area

- Composite toe cap
- Composite fibre penetration proof insole

EU	UK		
35	2,5	1	072230135
36	3,5	1	072230136
37	4,5	1	072230137
38	5	1	072230138
39	6	1	072230139
40	6,5	1	072230140
41	7	1	072230141
42	8	1	072230142
43	9	1	072230143
44	10	1	072230144
45	10,5	1	072230145
46	11	1	072230146
47	12	1	072230147
48	13	1	072230148



**EN ISO
20345
2011**



CE

S1P SRC

7224PEK

suede shoe, perforated, with anti-abrasion reinforcement in toe cap area

- Composite toe cap
- Composite fibre penetration proof insole

EU	UK	
35	2,5	1 072240235
36	3,5	1 072240236
37	4,5	1 072240237
38	5	1 072240238
39	6	1 072240239
40	6,5	1 072240240
41	7	1 072240241
42	8	1 072240242
43	9	1 072240243
44	10	1 072240244
45	10,5	1 072240245
46	11	1 072240246
47	12	1 072240247
48	13	1 072240248

CE



S1P SRC

EN ISO 20345 2011



FLEX

7212FG

suede shoe, perforated, with anti-abrasion insert in toe cap area
Extremely flexible and lightweight - approximate weight, size 42: 490 g
Not recommended for heavy-duty use (building, agriculture, heavy industry)

- Composite toe cap
- Composite fibre penetration-proof insole

EU	UK	
35	2,5	1 072120035
36	3,5	1 072120036
37	4,5	1 072120037
38	5	1 072120038
39	6	1 072120039
40	6,5	1 072120040
41	7	1 072120041
42	8	1 072120042
43	9	1 072120043
44	10	1 072120044
45	10,5	1 072120045
46	11	1 072120046
47	12	1 072120047
48	13	1 072120048

CE



FLEX



S1P SRC

EN ISO 20345 2011



7212LG

women's suede shoe, perforated, with mesh inserts
Extremely flexible and lightweight - approximate weight, size 38: 380 g
Not recommended for heavy-duty use (building, agriculture, heavy industry)

- Composite toe cap
- Composite fibre penetration-proof insole

EU	UK	
34	2	1 072120134
35	2,5	1 072120135
36	3,5	1 072120136
37	4,5	1 072120137
38	5	1 072120138
39	6	1 072120139
40	6,5	1 072120140
41	7	1 072120141
42	8	1 072120142

CE



lady



S1P SRC

EN ISO 20345 2011



7213FG

suede shoe with highly breathable mesh inserts

Extremely flexible and lightweight - approximate weight, size 42: 490 g

Not recommended for heavy-duty use (building, agriculture, heavy industry)

- Composite toe cap
- Composite fibre penetration-proof insole

EU	UK		
35	2,5	1	072130035
36	3,5	1	072130036
37	4,5	1	072130037
38	5	1	072130038
39	6	1	072130039
40	6,5	1	072130040
41	7	1	072130041
42	8	1	072130042
43	9	1	072130043
44	10	1	072130044
45	10,5	1	072130045
46	11	1	072130046
47	12	1	072130047
48	13	1	072130048

CE



S1P SRC

EN ISO 20345 2011



7214FN

Action nubuck shoe, waterproof, with anti-abrasion insert in toe cap area

Extremely flexible and lightweight - approximate weight size 42: 500 g

Not recommended for heavy-duty use (building, agriculture, heavy industry)

- Composite toe cap
- Composite fibre penetration-proof insole

EU	UK		
35	2,5	1	072140035
36	3,5	1	072140036
37	4,5	1	072140037
38	5	1	072140038
39	6	1	072140039
40	6,5	1	072140040
41	7	1	072140041
42	8	1	072140042
43	9	1	072140043
44	10	1	072140044
45	10,5	1	072140045
46	11	1	072140046
47	12	1	072140047
48	13	1	072140048

CE



S3 SRC

EN ISO 20345 2011



7214LN

women's suede shoe, waterproof, with anti-abrasion insert in toe cap area

Extremely flexible and lightweight - approximate weight, size 38: 380 g

Not recommended for heavy-duty use (building, agriculture, heavy industry)

- Composite toe cap
- Composite fibre penetration-proof insole

EU	UK		
34	2	1	072140134
35	2,5	1	072140135
36	3,5	1	072140136
37	4,5	1	072140137
38	5	1	072140138
39	6	1	072140139
40	6,5	1	072140140
41	7	1	072140141
42	8	1	072140142

CE



S3 SRC

EN ISO 20345 2011



7215FN

Action nubuck moccasin, waterproof, with anti-abrasion insert in toe cap area

Extremely flexible and lightweight - approximate weight, size 42: 490 g

Not recommended for heavy-duty use (building, agriculture, heavy industry)

- Composite toe cap
- Composite fibre penetration-proof insole

EU	UK		
35	2,5	1	072150135
36	3,5	1	072150136
37	4,5	1	072150137
38	5	1	072150138
39	6	1	072150139
40	6,5	1	072150140
41	7	1	072150141
42	8	1	072150142
43	9	1	072150143
44	10	1	072150144
45	10,5	1	072150145
46	11	1	072150146
47	12	1	072150147
48	13	1	072150148

CE



S3 SRC

EN ISO 20345 2011



7217FB

mesh shoe, highly breathable, with anti-abrasion insert in toe cap area • Composite toe cap
Extremely flexible and lightweight - approximate weight, size 42: 490 g • Composite fibre penetration-proof insole
Not recommended for heavy-duty jobs (building, agriculture, heavy industry)

EU	UK	Weight	Code
35	2,5	1	072170135
36	3,5	1	072170136
37	4,5	1	072170137
38	5	1	072170138
39	6	1	072170139
40	6,5	1	072170140
41	7	1	072170141
42	8	1	072170142
43	9	1	072170143
44	10	1	072170144
45	10,5	1	072170145
46	11	1	072170146
47	12	1	072170147
48	13	1	072170148

CE



S1P SRC

EN ISO 20345 2011



7217FG

mesh shoe, highly breathable, with anti-abrasion insert in toe cap area • Composite toe cap
Extremely flexible and lightweight - approximate weight, size 42: 490 g • Composite fibre penetration-proof insole
Not recommended for heavy-duty jobs (building, agriculture, heavy industry)

EU	UK	Weight	Code
35	2,5	1	072170235
36	3,5	1	072170236
37	4,5	1	072170237
38	5	1	072170238
39	6	1	072170239
40	6,5	1	072170240
41	7	1	072170241
42	8	1	072170242
43	9	1	072170243
44	10	1	072170244
45	10,5	1	072170245
46	11	1	072170246
47	12	1	072170247
48	13	1	072170248

CE



S1P SRC

EN ISO 20345 2011



7218FN

Action nubuck ankle shoe, water-repellent, with anti-abrasion insert in toe cap area and quick opening system • Composite toe cap
Extremely flexible and lightweight - approximate weight, size 42: 510 g • Composite fibre penetration proof insole
Not recommended for heavy-duty use (building, agriculture, heavy industry)

EU	UK	Weight	Code
35	2,5	1	072180035
36	3,5	1	072180036
37	4,5	1	072180037
38	5	1	072180038
39	6	1	072180039
40	6,5	1	072180040
41	7	1	072180041
42	8	1	072180042
43	9	1	072180043
44	10	1	072180044
45	10,5	1	072180045
46	11	1	072180046
47	12	1	072180047
48	13	1	072180048

CE



S3 RS SRC

EN ISO 20345 2011



7219FY

microfibre shoe, waterproof, with anti-abrasion insert in toe cap area • Composite toe cap
Extremely flexible and lightweight - approximate weight, size 42: 490 g • Composite fibre penetration-proof insole
Not recommended for heavy-duty jobs (building, agriculture, heavy industry)

EU	UK	Weight	Code
35	2,5	1	072190035
36	3,5	1	072190036
37	4,5	1	072190037
38	5	1	072190038
39	6	1	072190039
40	6,5	1	072190040
41	7	1	072190041
42	8	1	072190042
43	9	1	072190043
44	10	1	072190044
45	10,5	1	072190045
46	11	1	072190046
47	12	1	072190047
48	13	1	072190048

CE



S3 SRC

EN ISO 20345 2011



BASIC PLUS



7200BKK
full-grain leather shoe, waterproof

- Composite toe cap
- Composite fibre penetration proof insole

EU	UK	
35	2,5	1 072000235
36	3,5	1 072000236
37	4,5	1 072000237
38	5	1 072000238
39	6	1 072000239
40	6,5	1 072000240
41	7	1 072000241
42	8	1 072000242
43	9	1 072000243
44	10	1 072000244
45	10,5	1 072000245
46	11	1 072000246
47	12	1 072000247
48	13	1 072000248



CE

S3 SRC

EN ISO 20345 2011

7201BKK
full-grain leather ankle shoe, waterproof

- Composite toe cap
- Composite fibre penetration proof insole

EU	UK	
35	2,5	1 072010435
36	3,5	1 072010436
37	4,5	1 072010437
38	5	1 072010438
39	6	1 072010439
40	6,5	1 072010440
41	7	1 072010441
42	8	1 072010442
43	9	1 072010443
44	10	1 072010444
45	10,5	1 072010445
46	11	1 072010446
47	12	1 072010447
48	13	1 072010448



CE

S3 SRC

EN ISO 20345 2011

7210BKK
soft suede shoe, perforated

- Composite toe cap
- Composite fibre penetration proof insole

EU	UK	
35	2,5	1 072100335
36	3,5	1 072100336
37	4,5	1 072100337
38	5	1 072100338
39	6	1 072100339
40	6,5	1 072100340
41	7	1 072100341
42	8	1 072100342
43	9	1 072100343
44	10	1 072100344
45	10,5	1 072100345
46	11	1 072100346
47	12	1 072100347
48	13	1 072100348



CE

S1P SRC

EN ISO 20345 2011

7216BKK

soft suede sandal,
with strap closure

- Composite toe cap
- Composite fibre penetration proof insole

EU	UK	
35	2,5	1 072160335
36	3,5	1 072160336
37	4,5	1 072160337
38	5	1 072160338
39	6	1 072160339
40	6,5	1 072160340
41	7	1 072160341
42	8	1 072160342
43	9	1 072160343
44	10	1 072160344
45	10,5	1 072160345
46	11	1 072160346
47	12	1 072160347
48	13	1 072160348

CE



S1P SRC

EN ISO
20345
2011



7310CRK

lace-up black leather shoe, "welder" style, water-repellent,
with quick opening system and front protection with strap fastening
and flameproof seams
Hard-wearing rubber outsole and anti-abrasion insert in toe cap area

- Composite toe cap
- Composite fibre penetration proof insole

EU	UK	
35	2,5	1 073100335
36	3,5	1 073100336
37	4,5	1 073100337
38	5	1 073100338
39	6	1 073100339
40	6,5	1 073100340
41	7	1 073100341
42	8	1 073100342
43	9	1 073100343
44	10	1 073100344
45	10,5	1 073100345
46	11	1 073100346
47	12	1 073100347
48	13	1 073100348

CE



S3 RS HRO SRC

EN ISO
20345
2011



TREKKING



7235BK

Action Nubuck shoe, waterproof,
with reinforcement polyurethane toe cap cover

- Steel toe cap
- Composite fibre penetration-proof insole

EU	UK	
35	2,5	1 072350335
36	3,5	1 072350336
37	4,5	1 072350337
38	5	1 072350338
39	6	1 072350339
40	6,5	1 072350340
41	7	1 072350341
42	8	1 072350342
43	9	1 072350343
44	10	1 072350344
45	10,5	1 072350345
46	11	1 072350346
47	12	1 072350347
48	13	1 072350348

CE



S3 SRC

EN ISO
20345
2011



7236BK

Action Nubuck ankle shoe, waterproof, with quick opening system and reinforcement polyurethane toe cap cover

- Steel toe cap
- Composite fibre penetration-proof insole

EU	UK	
35	2,5	1 072360335
36	3,5	1 072360336
37	4,5	1 072360337
38	5	1 072360338
39	6	1 072360339
40	6,5	1 072360340
41	7	1 072360341
42	8	1 072360342
43	9	1 072360343
44	10	1 072360344
45	10,5	1 072360345
46	11	1 072360346
47	12	1 072360347
48	13	1 072360348

CE



S3 RS SRC

EN ISO
20345
2011



7238WR

suede ankle shoe with nylon inserts, durable rubber outsole and quick opening system
WR (water-resistant) footwear: after 1,000 steps in a tank with 3 cm of water, the wet internal surface has to be ≤ 3 cm² (spot)

- Composite toe cap
- Composite fibre penetration-proof insole

EU	UK	
35	2,5	1 072380235
36	3,5	1 072380236
37	4,5	1 072380237
38	5	1 072380238
39	6	1 072380239
40	6,5	1 072380240
41	7	1 072380241
42	8	1 072380242
43	9	1 072380243
44	10	1 072380244
45	10,5	1 072380245
46	11	1 072380246
47	12	1 072380247
48	13	1 072380248

CE



Endurance

S3 RS WR HRO SRC

EN ISO
20345
2011



7248GK

suede shoe with nylon inserts and reinforcement polyurethane toe cap cover

- Steel toe cap
- Composite fibre penetration-proof insole

EU	UK	
35	2,5	1 072480235
36	3,5	1 072480236
37	4,5	1 072480237
38	5	1 072480238
39	6	1 072480239
40	6,5	1 072480240
41	7	1 072480241
42	8	1 072480242
43	9	1 072480243
44	10	1 072480244
45	10,5	1 072480245
46	11	1 072480246
47	12	1 072480247
48	13	1 072480248

CE



S1P SRC

EN ISO
20345
2011



7249GK

suede ankle shoe with nylon inserts, quick opening system and reinforcement polyurethane toe cap cover

- Steel toe cap
- Composite fibre penetration-proof insole

EU	UK	
35	2,5	1 072490235
36	3,5	1 072490236
37	4,5	1 072490237
38	5	1 072490238
39	6	1 072490239
40	6,5	1 072490240
41	7	1 072490241
42	8	1 072490242
43	9	1 072490243
44	10	1 072490244
45	10,5	1 072490245
46	11	1 072490246
47	12	1 072490247
48	13	1 072490248

CE



S1P RS SRC

EN ISO
20345
2011



SNEAKERS



7252NKK

Nubuck ankle shoe, waterproof,
with waterproof microfibre inserts

- Composite toe cap with breathable membrane
- Composite fibre penetration proof insole

EU	UK	W	H	Code
38	5			1 072520138
39	6			1 072520139
40	6,5			1 072520140
41	7			1 072520141
42	8			1 072520142
43	9			1 072520143
44	10			1 072520144
45	10,5			1 072520145
46	11			1 072520146
47	12			1 072520147



Zolder



CE

S3 SRC

EN ISO
20345
2011



7253NKK

Nubuck ankle shoe, waterproof,
with waterproof microfibre inserts

- Composite toe cap
- Composite fibre penetration proof insole

EU	UK	W	H	Code
38	5			1 072530138
39	6			1 072530139
40	6,5			1 072530140
41	7			1 072530141
42	8			1 072530142
43	9			1 072530143
44	10			1 072530144
45	10,5			1 072530145
46	11			1 072530146
47	12			1 072530147



Zolder



CE

S3 SRC

EN ISO
20345
2011



7314AF

suede shoe
with nylon mesh and carbon inserts

- Composite toe cap
- Composite fibre penetration proof insole

EU	UK	W	H	Code
35	2,5			1 073140235
36	3,5			1 073140236
37	4,5			1 073140237
38	5			1 073140238
39	6			1 073140239
40	6,5			1 073140240
41	7			1 073140241
42	8			1 073140242
43	9			1 073140243
44	10			1 073140244
45	10,5			1 073140245
46	11			1 073140246
47	12			1 073140247
48	13			1 073140248



Active



CE

S1P SRC

EN ISO
20345
2011



7314AB
suede shoe
with nylon mesh and carbon inserts

- Composite toe cap
- Composite fibre penetration proof insole

EU	UK	
35	2,5	1 073140335
36	3,5	1 073140336
37	4,5	1 073140337
38	5	1 073140338
39	6	1 073140339
40	6,5	1 073140340
41	7	1 073140341
42	8	1 073140342
43	9	1 073140343
44	10	1 073140344
45	10,5	1 073140345
46	11	1 073140346
47	12	1 073140347
48	13	1 073140348

CE



S1P SRC

**EN ISO
20345
2011**



7317NA
suede shoe, perforated,
with microfibre reinforcement in heel area

- Composite toe cap
- Composite fibre penetration proof insole

EU	UK	
35	2,5	1 073170135
36	3,5	1 073170136
37	4,5	1 073170137
38	5	1 073170138
39	6	1 073170139
40	6,5	1 073170140
41	7	1 073170141
42	8	1 073170142
43	9	1 073170143
44	10	1 073170144
45	10,5	1 073170145
46	11	1 073170146
47	12	1 073170147
48	13	1 073170148

CE



S1P SRC

**EN ISO
20345
2011**



7320NA
nubuck shoe, water-repellent,
with antiabrasion reinforcement in toe cap area

- Composite toe cap
- Composite fibre penetration proof insole

EU	UK	
35	2,5	1 073200435
36	3,5	1 073200436
37	4,5	1 073200437
38	5	1 073200438
39	6	1 073200439
40	6,5	1 073200440
41	7	1 073200441
42	8	1 073200442
43	9	1 073200443
44	10	1 073200444
45	10,5	1 073200445
46	11	1 073200446
47	12	1 073200447
48	13	1 073200448

CE



S3 SRC

**EN ISO
20345
2011**



7321NA
nubuck shoe, water-repellent,
with quick opening system and antiabrasion reinforcement in
toe cap area

- Composite toe cap
- Composite fibre penetration proof insole

EU	UK	
35	2,5	1 073210435
36	3,5	1 073210436
37	4,5	1 073210437
38	5	1 073210438
39	6	1 073210439
40	6,5	1 073210440
41	7	1 073210441
42	8	1 073210442
43	9	1 073210443
44	10	1 073210444
45	10,5	1 073210445
46	11	1 073210446
47	12	1 073210447
48	13	1 073210448

CE



S3 RS SRC

**EN ISO
20345
2011**



7315AN

suede and microfibre shoe,
water-repellent, with carbon inserts

- Composite toe cap
- Composite fibre penetration proof insole

EU	UK	
35	2,5	1 073150535
36	3,5	1 073150536
37	4,5	1 073150537
38	5	1 073150538
39	6	1 073150539
40	6,5	1 073150540
41	7	1 073150541
42	8	1 073150542
43	9	1 073150543
44	10	1 073150544
45	10,5	1 073150545
46	11	1 073150546
47	12	1 073150547
48	13	1 073150548

CE



S3 SRC

EN ISO
20345
2011



7318AN

suede and microfibre ankle shoe,
water-repellent, with carbon inserts

- Composite toe cap
- Composite fibre penetration proof insole

EU	UK	
35	2,5	1 073180535
36	3,5	1 073180536
37	4,5	1 073180537
38	5	1 073180538
39	6	1 073180539
40	6,5	1 073180540
41	7	1 073180541
42	8	1 073180542
43	9	1 073180543
44	10	1 073180544
45	10,5	1 073180545
46	11	1 073180546
47	12	1 073180547
48	13	1 073180548

CE



S3 SRC

EN ISO
20345
2011



O-GRAVITY



7356G

microfibre shoe, water-repellent, with TPU inserts
Heel stability support, stretch slip-on collar
and EVA sole with durable nitrile rubber tread

- Composite toe cap
- Composite fibre penetration proof insole
- REMARKABLY LIGHTWEIGHT: approximate weight for size 42: 460 grams

EU	UK	
38	5	1 073560038
39	6	1 073560039
40	6,5	1 073560040
41	7	1 073560041
42	8	1 073560042
43	9	1 073560043
44	10	1 073560044
45	10,5	1 073560045
46	11	1 073560046
47	12	1 073560047
48	13	1 073560048

CE



S3 HRO SRC

EN ISO
20345
2011



7357G

microfibre ankle shoe, water-repellent, with TPU inserts
Heel stability support, stretch slip-on collar and EVA sole with durable nitrile rubber tread

- Composite toe cap
- Composite fibre penetration proof insole
- REMARKABLY LIGHTWEIGHT: approximate weight for size 42: 480 grams

EU	UK	
38	5	1 073570038
39	6	1 073570039
40	6,5	1 073570040
41	7	1 073570041
42	8	1 073570042
43	9	1 073570043
44	10	1 073570044
45	10,5	1 073570045
46	11	1 073570046
47	12	1 073570047
48	13	1 073570048



CE

S3 HRO SRC

EN ISO
20345
2011



7352A

mesh fabric shoe, highly breathable, with TPU inserts
Heel stability support, stretch slip-on collar and EVA outsole with durable nitrile rubber tread

- Composite toe cap
- Composite fibre penetration-proof insole
- REMARKABLY LIGHTWEIGHT: approximate weight, size 42: 450 g

EU	UK	
38	5	1 073520038
39	6	1 073520039
40	6,5	1 073520040
41	7	1 073520041
42	8	1 073520042
43	9	1 073520043
44	10	1 073520044
45	10,5	1 073520045
46	11	1 073520046
47	12	1 073520047
48	13	1 073520048



CE

S1P HRO SRC

EN ISO
20345
2011



7352B

mesh fabric shoe, highly breathable, with TPU inserts
Heel stability support, stretch slip-on collar and EVA outsole with durable nitrile rubber tread

- Composite toe cap
- Composite fibre penetration-proof insole
- REMARKABLY LIGHTWEIGHT: approximate weight, size 42: 450 g

EU	UK	
38	5	1 073520138
39	6	1 073520139
40	6,5	1 073520140
41	7	1 073520141
42	8	1 073520142
43	9	1 073520143
44	10	1 073520144
45	10,5	1 073520145
46	11	1 073520146
47	12	1 073520147
48	13	1 073520148



CE

S1P HRO SRC

EN ISO
20345
2011



7353Y

mesh fabric shoe, highly breathable, with TPU inserts
High-visibility reflective mesh upper
Heel stability support, stretch slip-on collar and EVA outsole with durable nitrile rubber tread

- Carbon fibre toe cap
- Composite fibre penetration-proof insole
- REMARKABLY LIGHTWEIGHT: approximate weight, size 42: 420 g

EU	UK	
38	5	1 073530038
39	6	1 073530039
40	6,5	1 073530040
41	7	1 073530041
42	8	1 073530042
43	9	1 073530043
44	10	1 073530044
45	10,5	1 073530045
46	11	1 073530046
47	12	1 073530047
48	13	1 073530048



CE

S1P HRO SRC

EN ISO
20345
2011



7354N

mesh fabric shoe, waterproof, with TPU inserts
Heel stability support, stretch slip-on collar and EVA outsole
with durable nitrile rubber tread

- Composite toe cap
- Composite fibre penetration-proof insole
- REMARKABLY LIGHTWEIGHT: approximate weight for size 42: 460 g

EU	UK	
38	5	1 073540038
39	6	1 073540039
40	6,5	1 073540040
41	7	1 073540041
42	8	1 073540042
43	9	1 073540043
44	10	1 073540044
45	10,5	1 073540045
46	11	1 073540046
47	12	1 073540047
48	13	1 073540048



CE

S3 HRO SRC

EN ISO
20345
2011



7355V

mesh fabric ankle shoe, waterproof, with TPU inserts
Heel stability support, stretch slip-on collar and EVA outsole
with durable nitrile rubber tread

- Composite toe cap
- Composite fibre penetration-proof insole
- REMARKABLY LIGHTWEIGHT: approximate weight for size 42: 465 g

EU	UK	
38	5	1 073550038
39	6	1 073550039
40	6,5	1 073550040
41	7	1 073550041
42	8	1 073550042
43	9	1 073550043
44	10	1 073550044
45	10,5	1 073550045
46	11	1 073550046
47	12	1 073550047
48	13	1 073550048



CE

S3 HRO SRC

EN ISO
20345
2011



7362B

occupational shoe, made of mesh fabric, highly breathable,
with TPU inserts
Heel stability support, stretch slip-on collar and EVA sole with
durable nitrile rubber tread

- Without toe cap
- Without penetration-proof insole
- REMARKABLY LIGHTWEIGHT: approximate weight for size 42: 330 grams

EU	UK	
39	6	1 073620039
40	6,5	1 073620040
41	7	1 073620041
42	8	1 073620042
43	9	1 073620043
44	10	1 073620044
45	10,5	1 073620045
46	11	1 073620046
47	12	1 073620047
48	13	1 073620048



CE

01 FO HRO SRC

EN ISO
20347
2012



7363N

occupational shoe, made of mesh fabric, water-repellent, with
TPU inserts
Heel stability support, stretch slip-on collar and EVA sole with
durable nitrile rubber tread

- Without toe cap
- Without penetration-proof insole
- REMARKABLY LIGHTWEIGHT: approximate weight for size 42: 330 grams

EU	UK	
39	6	1 073630039
40	6,5	1 073630040
41	7	1 073630041
42	8	1 073630042
43	9	1 073630043
44	10	1 073630044
45	10,5	1 073630045
46	11	1 073630046
47	12	1 073630047
48	13	1 073630048



CE

02 FO HRO SRC

EN ISO
20347
2012



SNEAKERS PRO



7340B
mesh fabric shoe, highly breathable,
with high-frequency PU inserts and protective toe cap
reinforcement made of crust suede.
Extremely lightweight - approximate weight, size 42: 470 g

- Aluminium toe cap
- Composite fibre penetration-proof insole
- FixLock closing makes it easier to put and remove the shoe (traditional laces included)

**EN ISO
20345
2011**



EU	UK	Weight	Product Code
36	3,5	1	073400236
37	4,5	1	073400237
38	5	1	073400238
39	6	1	073400239
40	6,5	1	073400240
41	7	1	073400241
42	8	1	073400242
43	9	1	073400243
44	10	1	073400244
45	10,5	1	073400245
46	11	1	073400246
47	12	1	073400247



FIT PRO NET

CE

S1P SRC

7340R
mesh fabric shoe, highly breathable,
with high-frequency PU inserts and protective toe cap
reinforcement made of crust suede.
Extremely lightweight - approximate weight, size 42: 470 g

- Aluminium toe cap
- Composite fibre penetration-proof insole
- FixLock closing makes it easier to put and remove the shoe (traditional laces included)

**EN ISO
20345
2011**



EU	UK	Weight	Product Code
36	3,5	1	073400436
37	4,5	1	073400437
38	5	1	073400438
39	6	1	073400439
40	6,5	1	073400440
41	7	1	073400441
42	8	1	073400442
43	9	1	073400443
44	10	1	073400444
45	10,5	1	073400445
46	11	1	073400446
47	12	1	073400447



FIT PRO NET

CE

S1P SRC

7341N
microsuede shoe, waterproof,
with high-frequency PU inserts and protective toe cap
reinforcement made of crust suede.
Extremely lightweight - approximate weight, size 42: 470 g

- Aluminium toe cap
- Composite fibre penetration-proof insole
- FixLock closing makes it easier to put and remove the shoe (traditional laces included)

**EN ISO
20345
2011**



EU	UK	Weight	Product Code
36	3,5	1	073410236
37	4,5	1	073410237
38	5	1	073410238
39	6	1	073410239
40	6,5	1	073410240
41	7	1	073410241
42	8	1	073410242
43	9	1	073410243
44	10	1	073410244
45	10,5	1	073410245
46	11	1	073410246
47	12	1	073410247



FIT PRO

CE

S3 SRC

7349RP

shoe made of Nubuck crust leather, waterproof with rubber outsole and soft PU ring

- Composite toe cap
- Composite fibre penetration proof insole

EU	UK	
38	5	1 073490138
39	6	1 073490139
40	6,5	1 073490140
41	7	1 073490141
42	8	1 073490142
43	9	1 073490143
44	10	1 073490144
45	10,5	1 073490145
46	11	1 073490146
47	12	1 073490147

CE



S3 HRO SRC

EN ISO 20345 2011



7350RP

ankle shoe made of Nubuck crust leather, waterproof with rubber outsole and soft PU ring

- Composite toe cap
- Composite fibre penetration proof insole

EU	UK	
38	5	1 073500138
39	6	1 073500139
40	6,5	1 073500140
41	7	1 073500141
42	8	1 073500142
43	9	1 073500143
44	10	1 073500144
45	10,5	1 073500145
46	11	1 073500146
47	12	1 073500147

CE



S3 HRO SRC

EN ISO 20345 2011



MANAGER



7300MK

full-grain leather shoe

- Composite toe cap
- Composite fibre penetration-proof insole

EU	UK	
36	3,5	1 073000636
37	4,5	1 073000637
38	5	1 073000638
39	6	1 073000639
40	6,5	1 073000640
41	7	1 073000641
42	8	1 073000642
43	9	1 073000643
44	10	1 073000644
45	10,5	1 073000645
46	11	1 073000646
47	12	1 073000647
48	13	1 073000648

CE



Indy



S3 SRC

EN ISO 20345 2011



7300FT

full-grain leather shoe, "free time" style, waterproof, without toe cap and penetration-proof insole

- Without toe cap
- Without penetration-proof insole

EU	UK		
36	3,5	1	073000736
37	4,5	1	073000737
38	5	1	073000738
39	6	1	073000739
40	6,5	1	073000740
41	7	1	073000741
42	8	1	073000742
43	9	1	073000743
44	10	1	073000744
45	10,5	1	073000745
46	11	1	073000746
47	12	1	073000747
48	13	1	073000748

Formula



CE

O2 FO SRC



7319ESD

suede shoe, perforated, ESD

- Composite toe cap
- Composite fibre penetration-proof insole

EU	UK		
36	3,5	1	073190236
37	4,5	1	073190237
38	5	1	073190238
39	6	1	073190239
40	6,5	1	073190240
41	7	1	073190241
42	8	1	073190242
43	9	1	073190243
44	10	1	073190244
45	10,5	1	073190245
46	11	1	073190246
47	12	1	073190247
48	13	1	073190248

Mistral



CE

S1P SRC ESD



HEAVY DUTY



7293HM

greased full-grain leather shoe, water-repellent, with high-performance VIBRAM® rubber tread, anti-abrasion insert on heel area and reinforcement polyurethane toe cap cover

- Fibreglass toe cap
- Composite fibre penetration proof insole

EU	UK		
39	6	1	072930639
40	6,5	1	072930640
41	7	1	072930641
42	8	1	072930642
43	9	1	072930643
44	10	1	072930644
45	10,5	1	072930645
46	11	1	072930646
47	12	1	072930647
48	13	1	072930648

Heritage



CE

S3 HRO HI SRC



7293HN

Nubuck shoe, waterproof, with SUPPORT SYSTEM for lateral ankle support
Durable rubber tread and PU toe cap
Wide body

- Steel toe cap
- Composite fibre penetration-proof insole

E	U	
39	6	1 072930839
40	6,5	1 072930840
41	7	1 072930841
42	8	1 072930842
43	9	1 072930843
44	10	1 072930844
45	10,5	1 072930845
46	11	1 072930846
47	12	1 072930847

CE



S3 HRO HI SRC



7294HM

greased full-grain leather ankle shoe, water-repellent, with high-performance VIBRAM® rubber tread, anti-abrasion insert on heel area and reinforcement polyurethane toe cap cover

- Fibreglass toe cap
- Composite fibre penetration proof insole

EU	UK	
39	6	1 072940639
40	6,5	1 072940640
41	7	1 072940641
42	8	1 072940642
43	9	1 072940643
44	10	1 072940644
45	10,5	1 072940645
46	11	1 072940646
47	12	1 072940647
48	13	1 072940648

CE



S3 HRO HI SRC



7294HMC

greased full-grain leather ankle shoe, water-repellent, with high-performance VIBRAM® rubber tread, anti-abrasion insert on heel area and reinforcement polyurethane toe cap cover. With Tepor membrane, waterproof, windproof, highly breathable

- Fibreglass toe cap
- Composite fibre penetration proof insole

EU	UK	
39	6	1 072940739
40	6,5	1 072940740
41	7	1 072940741
42	8	1 072940742
43	9	1 072940743
44	10	1 072940744
45	10,5	1 072940745
46	11	1 072940746
47	12	1 072940747
48	13	1 072940748

CE



S3 HRO HI CI WR SRC



7294HN

Nubuck ankle shoe, waterproof, with SUPPORT SYSTEM for lateral ankle support and quick opening system
Durable rubber tread and PU toe cap
Wide body

- Steel toe cap
- Composite fibre penetration-proof insole

EU	UK	
39	6	1 072940839
40	6,5	1 072940840
41	7	1 072940841
42	8	1 072940842
43	9	1 072940843
44	10	1 072940844
45	10,5	1 072940845
46	11	1 072940846
47	12	1 072940847

CE



S3 HRO HI RS SRC



ACCESSORIES

7398 O/G

anatomically shaped underfoot covers made of EVA foam, with cushioning heel pad (spare part recommended for 0-Gravity footwear range)



EU	UK		
38	5	1	073981238
39	6	1	073981239
40	6,5	1	073981240
41	7	1	073981241
42	8	1	073981242
43	9	1	073981243
44	10	1	073981244
45	10,5	1	073981245
46	11	1	073981246
47	12	1	073981247
48	13	1	073981248

7398U

anatomically shaped underfoot covers made of TPR GEL with high cushioning effect, plantar arch support and heel pad



EU	UK		
36 - 40	3,5 - 6,5	1	073980058
41 - 46	7 - 11	1	073980063

7398GEL

anatomically shaped underfoot covers with gel inserts



EU	UK		
35	2,5	1	073980835
36	3,5	1	073980836
37	4,5	1	073980837
38	5	1	073980838
39	6	1	073980839
40	6,5	1	073980840
41	7	1	073980841
42	8	1	073980842
43	9	1	073980843
44	10	1	073980844
45	10,5	1	073980845
46	11	1	073980846
47	12	1	073980847
48	13	1	073980848

7398EF

anatomically shaped underfoot covers made of polyurethane foam, with cushioning heel lift



EU	UK		
35	2,5	1	073981135
36	3,5	1	073981136
37	4,5	1	073981137
38	5	1	073981138
39	6	1	073981139
40	6,5	1	073981140
41	7	1	073981141
42	8	1	073981142
43	9	1	073981143
44	10	1	073981144
45	10,5	1	073981145
46	11	1	073981146
47	12	1	073981147
48	13	1	073981148

7399 A/N...

pack of 10 pairs of laces



	cm		
7399A/N 100	100	1	073990010
7399A/N 120	120	1	073990012
7399A/N 140	140	1	073990017

7421

knee-length socks made from elastic compression terry, with nylon and cotton reinforcements on toe and heel areas
Soles made from hard-wearing, antimycotic, breathable bamboo fibre



	EU		
M	39-42	1	074210002
L	43-46	1	074210004

7423

elastic compression ankle-length socks with nylon and cotton reinforcements on toe and heel areas
Soles made from hard-wearing, antimycotic, breathable bamboo fibre



	EU		
M	39-42	1	074230002
L	43-46	1	074230004

7425

ankle-length socks with breathable texture inserts and nylon/cotton reinforcements on toe and heel areas
Soles made from nylon woven with hard-wearing, antimycotic, breathable bamboo fibre



	EU		
M	39-42	1	074250002
L	43-46	1	074250004

7427

maxi sneaker socks with protective, breathable inserts on shinbone and instep areas.
Nylon and cotton reinforcements on toe and heel areas and soles made from hard-wearing, antimycotic, breathable fibre



	EU		
M	39-42	1	074270002
L	43-46	1	074270004

7429

maxi sneaker socks with breathable texture inserts and nylon/cotton reinforcements on toe and heel areas
Soles made from nylon woven with hard-wearing, antimycotic, breathable bamboo fibre



	EU		
M	39-42	1	074290002
L	43-46	1	074290004

7431P

two pairs of sneaker socks with breathable texture inserts and nylon/cotton reinforcements on toe and heel areas
Soles made from nylon woven with hard-wearing, antimycotic, breathable bamboo fibre.
One pair in black/orange colour and one pair in black/grey colour.



	EU		
M	39-42	1	074310102
L	43-46	1	074310104



WORKWEAR

Beta WORK

Over the years the workwear line has gained confidence and popularity among the most demanding professionals. The success of the product has translated into the ongoing development and expansion of the range.

The items of clothing produced by Beta Utensili S.p.a. comply with the following standard: **EN ISO 13688:2013**

Personal protective equipment protects the user from limited physical hazards, including small abrasions, sunbeams, wind, cold, non-harmful powders and dirt from nontoxic materials. Such protection is related to the first category of Italian Parliamentary Bill n°. 475 of 04/12/1992.

USE AND STORAGE INSTRUCTIONS

The garment should be worn correctly, so that it can protect the user's body parts. It should be stored in a cool, dry place, in its original packaging, away from heat sources, sunlight, dust and adverse weather.

PACKAGING

- WORKWEAR: hanging bag
- FREE TIME WEAR: non-hanging bag

SHRINKAGE

All natural fibres shrink after being washed. The degree of shrinkage may range from 1% to 5%, depending on several parameters, which include the type of fibres and the temperature of water.

	I	F	D	E	UK	USA
XS	46	38	42	40	30	32
S	48	40	44	42	32	34
M	50	42	46	44	34	36
L	52	44	48	46	36	38
XL	54	46	50	48	38	40
2XL	56	48	52	50	40	42
3XL	58	50	54	52	42	44
4XL	60	52	56	54	44	46

EN ISO 13688:2013								
	XS	S	M	L	XL	2XL	3XL	4XL
A	88-92	92-96	96-104	104-108	108-116	116-124	124-132	132-140
B	79-83	83-87	87-91	91-95	95-100	100-107	107-112	112-120
H	158-164	164-170	170-176	176-182	182-188	188-194	194-200	200-206

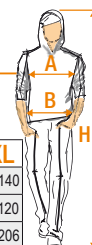

PANTS



7525

prewashed stretch work jeans, 68% denim cotton, 29% polyester, 3% stretch fabric, 10 ounces

CE



XS	1	075250046
S	1	075250048
M	1	075250050
L	1	075250052
XL	1	075250054
XXL	1	075250056
XXXL	1	075250058

7528

stretch work jeans trousers, 98% cotton, 2% stretch fabric, slim fit

CE



XS	1	075280046
S	1	075280048
M	1	075280050
L	1	075280052
XL	1	075280054
XXL	1	075280056
XXXL	1	075280058

7529

stretch work jeans bermuda shorts, 98% cotton, 2% stretch fabric, slim fit

CE



XS	1	075290046
S	1	075290048
M	1	075290050
L	1	075290052
XL	1	075290054
XXL	1	075290056
XXXL	1	075290058

7650

stretch work trousers, multipocket style 90% nylon - 10% spandex, 260 g/m², anthracite grey
Knee pad pockets, rear pockets and leg bottoms reinforced in polyester 600D, tearproof crotch

CE



XS	1	076500000
S	1	076500001
M	1	076500002
L	1	076500003
XL	1	076500004
XXL	1	076500005
XXXL	1	076500006

7810

"work trekking" trousers, multipocket style, HEAVY 90% nylon, 10% stretch fabric, 265 g/m², anthracite grey
Slim cut, ergonomic fit for ease of movement, bi-stretchable fabric for improved comfort.
Reinforced inserts on knees, crotch and leg bottom



S	1	078100101
M	1	078100102
L	1	078100103
XL	1	078100104
XXL	1	078100105

7811

"work trekking" trousers
90% nylon, 10% stretch fabric, 230 g/m², grey
Slim cut, ergonomic fit for ease of movement,
bi-stretchable fabric for improved comfort.
Reinforced inserts on knees, crotch and leg
bottom



Size	Quantity	SKU
S	1	078110001
M	1	078110002
L	1	078110003
XL	1	078110004
XXL	1	078110005

7812

"work trekking" trousers, LIGHT,
95% nylon, 5% stretch fabric, 140 g/m², grey
Slim cut, ergonomic fit for ease of movement,
bi-stretchable fabric for improved comfort,
reinforced inserts on knees, crotch and leg
bottom



Size	Quantity	SKU
S	1	078120001
M	1	078120002
L	1	078120003
XL	1	078120004
XXL	1	078120005

7813

"work trekking" Bermuda shorts, LIGHT,
95% nylon, 5% stretch fabric, 140 g/m², grey
Slim cut, ergonomic fit for ease of movement,
bi-stretchable fabric for improved comfort



Size	Quantity	SKU
S	1	078130001
M	1	078130002
L	1	078130003
XL	1	078130004
XXL	1	078130005

7816BL

work trousers, multipocket style, T/C canvas,
260 g/m², blue
Knee pad pockets and leg bottoms reinforced
in polyester 600D, tearproof crotch and stretch
rear insert for easier movements

CE



Size	Quantity	SKU
XS	1	078160100
S	1	078160101
M	1	078160102
L	1	078160103
XL	1	078160104
XXL	1	078160105
XXXL	1	078160106

7816G

work trousers, multipocket style, in T/C canvas
260 g/m², grey
Knee pad pockets and leg bottoms reinforced
in polyester 600D, tearproof crotch and elastic
rear insert for easier movements

CE



Size	Quantity	SKU
XS	1	078160000
S	1	078160001
M	1	078160002
L	1	078160003
XL	1	078160004
XXL	1	078160005
XXXL	1	078160006

7817N

"work trekking" trousers, multipocket style,
HEAVY,
90% nylon, 10% stretch fabric, 265 g/m², black
Slim cut, ergonomic fit for ease of movement
and bi-stretch fabric for improved comfort.
Reinforced inserts on knees, crotch and leg
bottom



Size	Quantity	SKU
S	1	078170101
M	1	078170102
L	1	078170103
XL	1	078170104
XXL	1	078170105



7819B

"work trekking" trousers, LIGHT, 95% nylon, 5% stretch fabric, 140 g/m², blue Slim cut, ergonomic fit for ease of movement and bi-stretch fabric for improved comfort. Reinforced inserts on knees, crotch and leg bottom



S	1	078190101
M	1	078190102
L	1	078190103
XL	1	078190104
XXL	1	078190105

7880SC

stretch work trousers, T/C canvas, 290 g/m², black Slim fit, tearproof crotch and stretch waistband on sides



XS	1	078800000
S	1	078800001
M	1	078800002
L	1	078800003
XL	1	078800004
XXL	1	078800005
XXXL	1	078800006

SHIRT & T-SHIRT



7547BL

three-button polo shirt, 100% cotton, 200 g/m², blue



XS	2	075470200
S	2	075470201
M	2	075470202
L	2	075470203
XL	2	075470204
XXL	2	075470205
XXXL	2	075470206

7547G

three-button polo shirt, 100% cotton, 200 g/m², grey



XS	2	075470300
S	2	075470301
M	2	075470302
L	2	075470303
XL	2	075470304
XXL	2	075470305
XXXL	2	075470306

7547N

three-button polo shirt, 100% cotton, 200 g/m², black



XS	2	075470400
S	2	075470401
M	2	075470402
L	2	075470403
XL	2	075470404
XXL	2	075470405
XXXL	2	075470406

7549BL

work t-shirt, 100% cotton, 150 g/m², blue



XS	5	075490200
S	5	075490201
M	5	075490202
L	5	075490203
XL	5	075490204
XXL	5	075490205
XXXL	5	075490206

7549G

work t-shirt, 100% cotton, 150 g/m², grey



XS	5	075490300
S	5	075490301
M	5	075490302
L	5	075490303
XL	5	075490304
XXL	5	075490305
XXXL	5	075490306

7549N

work t-shirt, 100% cotton, 150 g/m², black



XS	5	075490400
S	5	075490401
M	5	075490402
L	5	075490403
XL	5	075490404
XXL	5	075490405
XXXL	5	075490406

7634G

technical sweatshirt, long-zipped, 325 g/m²
67% polyester, 28% rayon, 5% spandex
3D fabric for improved breathability and
freedom of movement



XS	1	076340100
S	1	076340101
M	1	076340102
L	1	076340103
XL	1	076340104
XXL	1	076340105
XXXL	1	076340106

7657N

stretch microfleece sweater, long-zipped, 280
g/m², black
95% polyester, 5% spandex



XS	1	076570000
S	1	076570001
M	1	076570002
L	1	076570003
XL	1	076570004
XXL	1	076570005
XXXL	1	076570006

FLEECE



7634B

technical sweatshirt, long-zipped, 325 g/m²,
blue
67% polyester, 28% rayon, 5% spandex
3D fabric for improved breathability and
freedom of movement



XS	1	076340200
S	1	076340201
M	1	076340202
L	1	076340203
XL	1	076340204
XXL	1	076340205
XXXL	1	076340206

7635N

microfleece sweater, short-zipped, 180 g/m²
black



XS	1	076350500
S	1	076350501
M	1	076350502
L	1	076350503
XL	1	076350504
XXL	1	076350505
XXXL	1	076350506

7654N

stretch microfleece sweater, short-zipped, 180
g/m², black
95% polyester, 5% spandex



XS	1	076540000
S	1	076540001
M	1	076540002
L	1	076540003
XL	1	076540004
XXL	1	076540005
XXXL	1	076540006

7575N

sleeveless softshell jacket,
90% nylon, 10% stretch fabric, 250 g/m²



S	1	075750301
M	1	075750302
L	1	075750303
XL	1	075750304
XXL	1	075750305
XXXL	1	075750306

Beta

JACKETS



7577N

sleeveless jacket, 100% 50D microfibre polyester, padded, lined, black
Elastic insert at armhole



SIZE	QTY	SKU
XS	1	075770000
S	1	075770001
M	1	075770002
L	1	075770003
XL	1	075770004
XXL	1	075770005
XXXL	1	075770006

7579T

sleeveless work jacket, multipocket style, made of waterproof 300D nylon, with stretch inserts for ease of movement, black
Polyester padding, 140 g/m²



SIZE	QTY	SKU
S	1	075790001
M	1	075790002
L	1	075790003
XL	1	075790004
XXL	1	075790005
XXXL	1	075790006

7658N

softshell jacket, 94% polyester, 6% spandex, 290 g/m², anthracite grey
With waterproof, windproof, breathable TPU membrane (resistance to water columns up to 8,000 mm - breathability 8,000 mvp)



SIZE	QTY	SKU
S	1	076580001
M	1	076580002
L	1	076580003
XL	1	076580004
XXL	1	076580005
XXXL	1	076580006

7659N

softshell jacket, 94% polyester, 6% spandex, 290 g/m², with detachable hood and sleeves, black
With waterproof, windproof, breathable TPU membrane (resistance to water columns up to 8,000 mm - breathability 8,000 mvp)



SIZE	QTY	SKU
S	1	076590001
M	1	076590002
L	1	076590003
XL	1	076590004
XXL	1	076590005
XXXL	1	076590006

7734

triple use Anorak jacket made of Oxford polyester 300D, waterproof, PU-coated, grey
With foldaway hood and detachable interior jacket, 100% made of polyester, black



SIZE	QTY	SKU
S	1	077340001
M	1	077340002
L	1	077340003
XL	1	077340004
XXL	1	077340005
XXXL	1	077340006

7780T

work bomber jacket, multipocket style, made from waterproof nylon 300D, with stretch inserts for ease of movement, black
Polyester padding, 160 g/m², detachable hood



SIZE	QTY	SKU
S	1	077800101
M	1	077800102
L	1	077800103
XL	1	077800104
XXL	1	077800105
XXXL	1	077800106

BASIC

7840BL

work trousers, T/C twill, 245 g/m², blue
Stretch waistband on sides



BetaEASY



SIZE	QTY	SKU
XS	1	078400100
S	1	078400101
M	1	078400102
L	1	078400103
XL	1	078400104
XXL	1	078400105
XXXL	1	078400106
XXXXL	1	078400107

7849BL

work jacket, T/C twill, 245 g/m², blue
Stretch waistband

CE

BetaEASY



XS	1	078490100
S	1	078490101
M	1	078490102
L	1	078490103
XL	1	078490104
XXL	1	078490105
XXXL	1	078490106
XXXXL	1	078490107

EASY LIGHT

7860G

work trousers, lightweight,
in T/C twill, 180 g/m², with Oxford inserts, grey
New design - Improved fit

CE

BetaEASY

LIGHT



XS	1	078600800
S	1	078600801
M	1	078600802
L	1	078600803
XL	1	078600804
XXL	1	078600805
XXXL	1	078600806
XXXXL	1	078600807

7861G

work Bermuda shorts, lightweight,
in T/C twill, 180 g/m², with Oxford inserts, grey
New design - Improved fit

CE

BetaEASY

LIGHT



XS	1	078610800
S	1	078610801
M	1	078610802
L	1	078610803
XL	1	078610804
XXL	1	078610805
XXXL	1	078610806
XXXXL	1	078610807

7863G

work bib and brace overalls, lightweight,
in T/C twill, 180 g/m², with Oxford inserts, grey
New design - Improved fit

CE

BetaEASY

LIGHT



XS	1	078630800
S	1	078630801
M	1	078630802
L	1	078630803
XL	1	078630804
XXL	1	078630805
XXXL	1	078630806
XXXXL	1	078630807



7865G

work overalls, lightweight,
in T/C twill, 180 g/m², with Oxford inserts, grey
New design - Improved fit

CE

BetaEASY

LIGHT



XS	1	078650800
S	1	078650801
M	1	078650802
L	1	078650803
XL	1	078650804
XXL	1	078650805
XXXL	1	078650806
XXXXL	1	078650807

7867G

sleeveless work jacket, lightweight,
in T/C twill, 180 g/m², with Oxford inserts, grey
New design - Improved fit

CE

BetaEASY

LIGHT



XS	1	078670800
S	1	078670801
M	1	078670802
L	1	078670803
XL	1	078670804
XXL	1	078670805
XXXL	1	078670806
XXXXL	1	078670807



7869G

work jacket, lightweight,
in T/C twill, 180 g/m², with Oxford inserts, grey
New design - Improved fit

CE

Beta EASY

LIGHT



XS	1	078690800
S	1	078690801
M	1	078690802
L	1	078690803
XL	1	078690804
XXL	1	078690805
XXXL	1	078690806
XXXXL	1	078690807

EASY



7900G

work trousers, in T/C canvas, 260 g/m², with
Oxford inserts, grey
New design - Improved fit

CE

Beta EASY



XS	1	079000800
S	1	079000801
M	1	079000802
L	1	079000803
XL	1	079000804
XXL	1	079000805
XXXL	1	079000806
XXXXL	1	079000807

7900P

work trousers,
in T/C canvas, 260 g/m², with Oxford inserts,
petrol blue

CE

Beta EASY



XS	1	079000600
S	1	079000601
M	1	079000602
L	1	079000603
XL	1	079000604
XXL	1	079000605
XXXL	1	079000606
XXXXL	1	079000607

7900B

work trousers,
in T/C canvas, 260 g/m², with Oxford inserts,
blue

CE

Beta EASY



XS	1	079000700
S	1	079000701
M	1	079000702
L	1	079000703
XL	1	079000704
XXL	1	079000705
XXXL	1	079000706
XXXXL	1	079000707

7900V

work trousers, in T/C canvas, 260 g/m², with
Oxford inserts, green

CE

Beta EASY



XS	1	079000500
S	1	079000501
M	1	079000502
L	1	079000503
XL	1	079000504
XXL	1	079000505
XXXL	1	079000506
XXXXL	1	079000507

7901G

work Bermuda shorts, in T/C canvas, 260 g/
m², with Oxford inserts, grey
New design - Improved fit

CE

Beta EASY



XS	1	079010800
S	1	079010801
M	1	079010802
L	1	079010803
XL	1	079010804
XXL	1	079010805
XXXL	1	079010806
XXXXL	1	079010807



7903G

work bib and brace overalls, in T/C canvas, 260 g/m², with Oxford inserts, grey
New design - Improved fit

CE

BetaEASY



XS	1	079030800
S	1	079030801
M	1	079030802
L	1	079030803
XL	1	079030804
XXL	1	079030805
XXXL	1	079030806
XXXXL	1	079030807

7903P

work bib and brace overalls, in T/C canvas, 260 g/m², with Oxford inserts, petrol blue

CE

BetaEASY



XS	1	079030600
S	1	079030601
M	1	079030602
L	1	079030603
XL	1	079030604
XXL	1	079030605
XXXL	1	079030606
XXXXL	1	079030607

7905G

work overalls in T/C canvas, 260 g/m², with Oxford inserts, grey
New design - Improved fit

CE

BetaEASY



XS	1	079050800
S	1	079050801
M	1	079050802
L	1	079050803
XL	1	079050804
XXL	1	079050805
XXXL	1	079050806
XXXXL	1	079050807

7904N

work bomber jacket, padded, made of T/C canvas, 270 g/m², "Oxford" inserts, black
Polyester padding, 140 g/m²

BetaEASY



XS	1	079040800
S	1	079040801
M	1	079040802
L	1	079040803
XL	1	079040804
XXL	1	079040805
XXXL	1	079040806
XXXXL	1	079040807



7907G

sleeveless work jacket, in T/C canvas, 260 g/m², with Oxford inserts, grey
New design - Improved fit

CE

BetaEASY



XS	1	079070800
S	1	079070801
M	1	079070802
L	1	079070803
XL	1	079070804
XXL	1	079070805
XXXL	1	079070806
XXXXL	1	079070807

7907P

sleeveless work jacket, in T/C canvas, 260 g/m², with Oxford inserts, petrol blue

CE

BetaEASY



XS	1	079070600
S	1	079070601
M	1	079070602
L	1	079070603
XL	1	079070604
XXL	1	079070605
XXXL	1	079070606
XXXXL	1	079070607

7909G

work jacket, in T/C canvas, 260 g/m², with Oxford inserts, grey
New design - Improved fit

CE

BetaEASY



XS	1	079090800
S	1	079090801
M	1	079090802
L	1	079090803
XL	1	079090804
XXL	1	079090805
XXXL	1	079090806
XXXXL	1	079090807

7909V

work jacket, in T/C canvas, 260 g/m², with Oxford inserts, green

CE

Beta EASY



XS	1	079090500
S	1	079090501
M	1	079090502
L	1	079090503
XL	1	079090504
XXL	1	079090505
XXXL	1	079090506
XXXXL	1	079090507

7909P

work jacket, in T/C canvas, 260 g/m², with Oxford inserts, petrol blue

CE

Beta EASY



XS	1	079090600
S	1	079090601
M	1	079090602
L	1	079090603
XL	1	079090604
XXL	1	079090605
XXXL	1	079090606
XXXXL	1	079090607

7909B

work jacket, in T/C canvas, 260 g/m², with Oxford inserts, blue

CE

Beta EASY



XS	1	079090700
S	1	079090701
M	1	079090702
L	1	079090703
XL	1	079090704
XXL	1	079090705
XXXL	1	079090706
XXXXL	1	079090707

STRETCH

7830ST

stretch work trousers, T/C twill, 250 g/m², grey
Slim fit, tearproof crotch and stretch waistband on sides

CE



XS	1	078300000
S	1	078300001
M	1	078300002
L	1	078300003
XL	1	078300004
XXL	1	078300005
XXXL	1	078300006

Beta

7831ST

stretch work Bermuda shorts, T/C twill, 250 g/m², grey
Slim fit, tearproof crotch and stretch waistband on sides

CE



XS	1	078310000
S	1	078310001
M	1	078310002
L	1	078310003
XL	1	078310004
XXL	1	078310005
XXXL	1	078310006

7833ST

stretch work overalls, T/C twill, 250 g/m², grey
Slim fit, tearproof crotch and stretch waistband

CE



XS	1	078330000
S	1	078330001
M	1	078330002
L	1	078330003
XL	1	078330004
XXL	1	078330005
XXXL	1	078330006

7835ST

stretch work overalls,
T/C twill, 250 g/m², grey
Slim fit, tearproof crotch and stretch waistband

CE



Size	SKU
XS	1 078350000
S	1 078350001
M	1 078350002
L	1 078350003
XL	1 078350004
XXL	1 078350005
XXXL	1 078350006

TOP LINE

7820

work trousers, twisted T/C canvas, 280 g/m²,
Cordura® and Reflex 3M Scotchlite™ insets,
black/grey

CE



Size	SKU
XS	1 078200000
S	1 078200001
M	1 078200002
L	1 078200003
XL	1 078200004
XXL	1 078200005
XXXL	1 078200006
XXXXL	1 078200007

7821

work Bermuda shorts, twisted T/C canvas, 280
g/m², black/grey

CE



Size	SKU
XS	1 078210000
S	1 078210001
M	1 078210002
L	1 078210003
XL	1 078210004
XXL	1 078210005
XXXL	1 078210006
XXXXL	1 078210007

7823

work overalls, twisted T/C canvas, 280 g/m²,
Cordura® and Reflex 3M Scotchlite™ insets,
black/grey

CE



Size	SKU
XS	1 078230000
S	1 078230001
M	1 078230002
L	1 078230003
XL	1 078230004
XXL	1 078230005
XXXL	1 078230006
XXXXL	1 078230007

7825

work overalls, twisted T/C canvas, 280 g/m²,
Cordura® and Reflex 3M Scotchlite™ insets,
black/grey

CE



Size	SKU
XS	1 078250000
S	1 078250001
M	1 078250002
L	1 078250003
XL	1 078250004
XXL	1 078250005
XXXL	1 078250006
XXXXL	1 078250007

Beta

7829

work jacket, twisted T/C canvas, 280 g/m², Cordura® and Reflex 3M Scotchlite™ insets, black/grey

CE



XS	1	078290000
S	1	078290001
M	1	078290002
L	1	078290003
XL	1	078290004
XXL	1	078290005
XXXL	1	078290006
XXXXL	1	078290007

7931G

work Bermuda shorts, 100% stretch cotton, 220 g/m² Slim fit

CE



XS	1	079310300
S	1	079310301
M	1	079310302
L	1	079310303
XL	1	079310304
XXL	1	079310305
XXXL	1	079310306



7935G

work overalls, 100% stretch cotton, 220 g/m² Slim fit

CE



XS	1	079350300
S	1	079350301
M	1	079350302
L	1	079350303
XL	1	079350304
XXL	1	079350305
XXXL	1	079350306

COTTON

7930G

work trousers, 100% stretch cotton, 220 g/m² Slim fit

CE



XS	1	079300300
S	1	079300301
M	1	079300302
L	1	079300303
XL	1	079300304
XXL	1	079300305
XXXL	1	079300306

7933G

work overalls, 100% stretch cotton, 220 g/m² Slim fit

CE



XS	1	079330300
S	1	079330301
M	1	079330302
L	1	079330303
XL	1	079330304
XXL	1	079330305
XXXL	1	079330306

7939G

work jacket, 100% stretch cotton, 220 g/m² Slim fit

CE



XS	1	079390300
S	1	079390301
M	1	079390302
L	1	079390303
XL	1	079390304
XXL	1	079390305
XXXL	1	079390306



RAIN

7970

waterproof trousers in PVC Tricot, blue

CE



EN 343

Size	Quantity	Product Code
XS	1	079700000
S	1	079700001
M	1	079700002
L	1	079700003
XL	1	079700004
XXL	1	079700005
XXXL	1	079700006

7971L

waterproof trousers, made of PVC-coated polyester, with thermo-taped seams, blue
With elastic waistband and adjustable press-stud leg bottom

CE



EN 343

Size	Quantity	Product Code
XS	1	079710100
S	1	079710101
M	1	079710102
L	1	079710103
XL	1	079710104
XXL	1	079710105
XXXL	1	079710106

7978L

waterproof full-length jacket, made of PVC-coated polyester, with fixed hood and thermo-taped seams, blue
Fitted with press studs for use as a 3/4 length jacket

CE



EN 343

Size	Quantity	Product Code
XS	1	079780100
S	1	079780101
M	1	079780102
L	1	079780103
XL	1	079780104
XXL	1	079780105
XXXL	1	079780106

7979

waterproof jacket in PVC Tricot, blue

CE



Size	Quantity	Product Code
S	1	079790001
M	1	079790002
L	1	079790003
XL	1	079790004
XXL	1	079790005
XXXL	1	079790006

Beta

UNDERWEAR

7991N

technical underpants, 100% polyester, 130 g/m², black



Size	Quantity	Product Code
S	1	079910001
M	1	079910002
L	1	079910003
XL	1	079910004
XXL	1	079910005

7992N

technical undershirt, long-sleeved, 100% polyester, 130 g/m², black



Size	Quantity	Product Code
S	1	079920001
M	1	079920002
L	1	079920003
XL	1	079920004
XXL	1	079920005

Beta

ACCESSORIES

7800G

work knee pads pair



7800G

1 078000500

7980N

rainproof cap
100% PU-coated polyester
with water-repellent treatment



L = Ø 58 cm
XL = Ø 60 cm

1 079800058
1 079800060

7980R

cuffed winter cap, 100% acrylic,
3M Thinsulate™ padding, black



7980R

10 079800111

7984G

work belt, 100% TPE, with chrome-plated zinc
metal buckle
one size fits all; length: 125 cm, can be
shortened; width: 35 mm,
black



7984G

1 079840525

7985

neck warmer made of microfleece, with
adjuster, black
can also be used as a cap

CE



7985

10 079850111

7104 90

plastic posts with fillable bases



H
mm
90

4 071040004

7105 6

plastic barrier chain



Ø L
mm m
6 25

1 071050006

7109A

aluminium warning signs



H
mm
7109A1 140
7109A2 140
7109A3 140
7109A4 140

1 071090001
1 071090002
1 071090003
1 071090004

7109D

prohibition signs



H
mm
7109D1 115
7109D2 115
7109D3 115

1 071090051
1 071090052
1 071090053

7195A

dust mask

CE



7195A

10 071950004

7051MP

eye protector
with polycarbonate visor

CE



EN166

7051MP

5 070510001

7061TC

safety glasses with clear polycarbonate lenses

CE

EASY



7061TC

1 070610001

7076BC

safety glasses with clear polycarbonate lenses

CE

SPORT



EN166F-1F
EN172
UV 5-3.1

7076BC

1 070760009

7076BD

safety glasses with polycarbonate lenses

CE

SPORT



EN166F-1F
EN170
UV 5-2.5

7076BD

1 070760019

7076BP

safety glasses with polarized polycarbonate
lenses

CE

SPORT



EN12312-1

7076BP

1 070760029

7076BU

leak detection glasses with UV lights

CE



EN12312-1

7076BU

1 070760039

7093BC

safety glasses with clear polycarbonate lenses

CE

IMPACT



EN166F-1F
EN170
UV400

7093BC

1 070930009

7093BD

safety glasses with dark polycarbonate lenses

CE

IMPACT



EN166F-1F
EN172
UV5-2.5

7093BD

1 070930019

C62M/W

mannequin



185 cm

65 cm

C62M/W

1 062000360

C63 E/W

clothing and footwear display stand



2250 mm

515 mm

1010 mm

C63E/W

1 063000010

C63 G/C

footwear "gondola" display



1010 mm

1010 mm

515 mm

C63G/C

1 063000020

6200AP/S10

set of 10 hangers



6200AP/S10

1 062000331

9562TB

mat for trying on shoes, with anti-skid, rubber-coated bottom



600 mm

800 mm

9562TB

1 095620500





Since 1930 Robur has been manufacturing accessory lines for cables according to the acknowledged quality standards of Beta Utensili, whose products are complementary to those of Robur.

Expertise, organization and technology are the key ingredients of ongoing growth resulting from awareness of market requirements.

Since 1984 Robur has been headquartered in a state-of-the-art production facility in Sulmona.



Special free service boxes

MAXIMUM WORKING LOAD

WLL: working load limit (for lifting accessories)

WFL: workforce limit (for accessories other than lifting accessories)

BF: maximum force achieved by the item during the static traction test

LC: lashing capacity

8049A

new item 2021

lifting eyebolts,
double swivel ring, turnable under load,
with welded ring,
high-tensile alloy steel

CE



TECHNICAL DATA

- safety factor: 4 • heat treatment: hardening
- traceability code

LABORATORY TESTS

- chemical analysis
- metallographic analysis
- tensile test
- fatigue test (20,000 cycles)
- testing load (100% of batch)

AVAILABLE CERTIFICATES

- Technical product specifications
- Test report UNI EN10204 type 2.2
- Inspection certificate UNI EN10204 type 3.1
- CE Declaration of Conformity

size	Ø mm	E mm	A mm	WLL kg		
M8	13	30	300		1	080490108
M10	19	30	450		1	080490110
M12	19	30	500		1	080490112
M16	20	30	1120		1	080490116
M20	30	40	2000		1	080490120
M24	30	40	3150		1	080490124
M30	35	50	5300		1	080490130

code number

n.° of tools
per box

8105
eye and eye turnbuckles
high tensile steel, hot dip galvanized

CE



TECHNICAL DATA

- safety factor: 5
- heat treatment, body: normalizing
- heat treatment, eyes: hardening and tempering

LABORATORY TESTS

- chemical analysis
- tensile test

- proof load test 2 x WFL

AVAILABLE CERTIFICATES

- Technical product specifications
- Test report UNI EN10204 type 2.2

ØxE "	mm	WFL kg		
3/8x6	M10x150	540	5	081050010
1/2x6	M12x150	1000	5	081050011
1/2x9	M12x230	1000	5	081050012
5/8x9	M16x230	1590	2	081050016
5/8x12	M16x300	1590	2	081050015
3/4x6	M20x150	2360	2	081050017
3/4x9	M20x230	2360	2	081050020
3/4x12	M20x300	2360	2	081050018
3/4x18	M20x460	2360	2	081050021
7/8x12	M22x300	3270	1	081050022
1x6	M24x150	4540	1	081050024
1x12	M24x300	4540	1	081050025
1.1/4x12	M33x300	6900	1	081050031
1.1/4x18	M33x460	6900	1	081050032
1.1/2x12	M39x300	9710	1	081050034
1.1/2x18	M39x460	9710	1	081050035
1.3/4x18	M45x460	12700	1	081050036

Other sizes available upon request

special free service boxes

ØxE "			
3/8x6	1	1	081059010
1/2x9	1	1	081059012

8109
jaw and jaw turnbuckles
high tensile steel, hot dip galvanized

CE



TECHNICAL DATA

- safety factor: 5
- heat treatment, body: normalizing
- heat treatment, jaws: hardening and tempering

LABORATORY TESTS

- chemical analysis
- tensile test

AVAILABLE CERTIFICATES

- Technical product specifications
- Test report UNI EN10204 type 2.2

ØxE "	mm	WFL kg		
3/8x6	M10x150	540	5	081090010
1/2x6	M12x150	1000	5	081090011
1/2x9	M12x230	1000	5	081090012
1/2x12	M12x300	1000	5	081090013
5/8x6	M16x150	1590	2	081090015

ØxE "	mm	WFL kg		
5/8x9	M16x230	1590	2	081090016
5/8x12	M16x300	1590	2	081090017
3/4x6	M20x150	2360	2	081090018
3/4x9	M20x230	2360	2	081090020
3/4x12	M20x300	2360	2	081090019
3/4x18	M20x460	2360	2	081090021
7/8x12	M22x300	3270	1	081090022
7/8x18	M22x460	3270	1	081090023
1x6	M24x150	4540	1	081090024
1x12	M24x300	4540	1	081090025
1x18	M24x460	4540	1	081090026
* 1.1/4x12	M33x300	6900	1	081090031
* 1.1/4x18	M33x460	6900	1	081090032
* 1.1/4x24	M33x610	6900	1	081090033
* 1.1/2x12	M39x300	9710	1	081090034
* 1.3/4x18	M45x460	12700	1	081090036
* 1.1/2x18	M39x460	9710	1	081090038
* 1.1/2x24	M39x610	9710	1	081090039

* Round pin Jaw

Other sizes available upon request

special free service boxes

ØxE "			
3/8x6	1	1	081099010
1/2x9	1	1	081099012

8110
eye and jaw turnbuckles, high-tensile steel,
hot dip galvanized

CE



TECHNICAL DATA

- safety factor: 5
- turnbuckle body treatment: normalizing
- turnbuckle eye treatment: hardening and tempering
- traceability code

LABORATORY TESTS

- chemical analysis
- tensile test

AVAILABLE CERTIFICATES

- Technical product specifications
- Test report UNI EN10204 type 2.2
- Inspection certificate UNI EN10204 type 3.1
- CE Declaration of Conformity

ØxE "	mm	WFL kg		
1/2x9	M12x230	1000	5	081100010
5/8x12	M16x300	1590	2	081100016
3/4x6	M20x150	2360	2	081100019
3/4x9	M20x230	2360	2	081100020
3/4x12	M20x300	2360	2	081100021
7/8x12	M22x300	3270	1	081100022
1x6	M24x150	4540	1	081100027
1x12	M24x300	4540	1	081100029
* 1.1/4x12	M33x300	6900	1	081100034
* 1.1/2x12	M39x300	9710	1	081100038
* 1.1/2x18	M39x460	9710	1	081100039
* 1.3/4x18	M45x460	12700	1	081100044

* Jaw with through pin and split pin



8005Z

eye and eye turnbuckles,
galvanized

CE

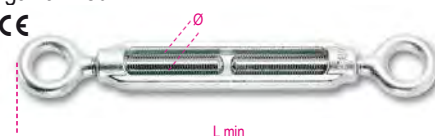

TECHNICAL DATA

- safety factor: 4
- LABORATORY TESTS
- chemical analysis
- tensile test

AVAILABLE CERTIFICATES

- Technical product specifications
- Test report UNI EN10204 type 2.2
- CE Declaration of Conformity

Ø mm	mm	L min mm	WFL kg		
M5	3/16	118	115	400	080050105
M6	1/4	130	160	300	080050106
M8	5/16	158	300	200	080050108
M10	3/8	192	470	100	080050110
M11	7/16	206	580	80	080050111
M12	1/2	226	690	60	080050112
M14	9/16	256	940	15	080050114
M16	5/8	290	1290	10	080050116
M18	11/16	358	1660	1	080050118
M20	3/4	358	2130	1	080050120
M22	7/8	400	2630	1	080050122
M24	1"	436	3060	1	080050124
M27	1 1/8	474	4000	1	080050125
M30	1 3/16	498	4860	1	080050130
M33	1 1/4	516	6040	1	080050126
M36	1 3/8	532	6500	1	080050136
M39	1 1/2	544	7900	1	080050139

Whitworth thread subject to availability
New batches with metric thread

special packaging

Ø mm				
M5	3/16	30	1	080050705
M6	1/4	30	1	080050706
M8	5/16	20	1	080050708
M10	3/8	15	1	080050710
M11	7/16	15	1	080050711
M12	1/2	15	1	080050712

special free service boxes

Ø mm				
M5	2	1	080059305	
M6	2	1	080059306	
M8	1	1	080059108	
M10	1	1	080059110	
M11	1	1	080059111	
M12	1	1	080059112	
M14	1	1	080059114	
M16	1	1	080059116	



8005TZ

hot-forged eye and eye turnbuckles
pipe bodies,galvanized



TECHNICAL DATA

- safety factor: 4

LABORATORY TESTS

- chemical analysis
- tensile test

AVAILABLE CERTIFICATES

- Technical product specifications
- Test report UNI EN10204 type 2.2

- CE Declaration of Conformity

Ø mm	≈ "	WFL kg	15	30
M12	1/2	690	15	080050512
M16	5/8	1290	1	080050516
M20	3/4	2130	1	080050520
M24	1"	3060	1	080050524
M27	1.1/8	4000	1	080050527
M30	1.3/16	4860	1	080050530
M36	1.3/8	6500	1	080050536

special free service boxes

Ø mm	1	1	080059512
M12	1	1	080059512

8006Z

hook and eye turnbuckles,
galvanized

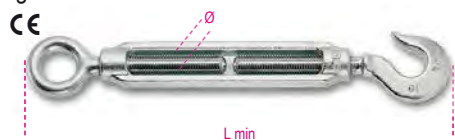

TECHNICAL DATA

- safety factor: 4

LABORATORY TESTS

- chemical analysis
- tensile test

AVAILABLE CERTIFICATES

- Technical product specifications
- Test report UNI EN10204 type 2.2
- CE Declaration of Conformity

Ø mm	≈ "	L min mm	WFL kg	400	250
M5	3/16	121	25	400	080060105
M6	1/4	132	45	250	080060106
M8	5/16	170	95	180	080060108
M10	3/8	204	140	100	080060110
M11	7/16	221	165	15	080060111
M12	1/2	244	300	15	080060112
M14	9/16	284	420	10	080060114
M16	5/8	322	570	1	080060116
M18	11/16	373	700	1	080060118
M20	3/4	391	900	1	080060120
M22	7/8	433	1100	1	080060122
M24	1"	470	1300	1	080060124
M27	1 1/8	503	2300	1	080060127

special packaging

Ø mm	≈ "	30	1	080060705
M5	3/16	30	1	080060705
M6	1/4	30	1	080060706
M8	5/16	20	1	080060708
M10	3/8	15	1	080060710

special free service boxes



Ø mm	2	1	080069305
M5	2	1	080069305
M6	2	1	080069306
M8	1	1	080069108
M10	1	1	080069110
M11	1	1	080069111
M12	1	1	080069112
M14	1	1	080069114

8007Z

hook and hook turnbuckles,
galvanized

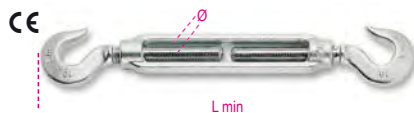

TECHNICAL DATA

- safety factor: 4

LABORATORY TESTS

- chemical analysis
- tensile test

AVAILABLE CERTIFICATES

- Technical product specifications
- Test report UNI EN10204 type 2.2
- CE Declaration of Conformity

Ø mm	≈ "	L min mm	WFL kg	30	30
M5	3/16	124	25	30	080070105
M6	1/4	134	45	30	080070106
M8	5/16	181	95	20	080070108
M10	3/8	211	140	15	080070110
M11	7/16	231	165	15	080070111
M12	1/2	262	300	15	080070112
M14	9/16	312	420	1	080070114
M16	5/8	354	570	1	080070116
M18	11/16	388	700	1	080070118
M20	3/4	424	900	1	080070120
M22	7/8	466	1100	1	080070122
M24	1"	504	1300	1	080070124
M27	1 1/8	532	2300	1	080070127

special free service boxes



Ø mm	2	1	080079305
M5	2	1	080079305
M6	2	1	080079306
M8	1	1	080079108
M10	1	1	080079110
M11	1	1	080079111
M12	1	1	080079112

8008N

stub and stub turnbuckles
self-coloured



TECHNICAL DATA

- safety coefficient: 4

LABORATORY TESTS

- chemical analysis
- tensile test

AVAILABLE CERTIFICATES

- Technical product specifications
- Test report UNI EN10204 type 2.2
- CE Declaration of Conformity

Ø mm	≈ "	L min mm	WFL kg	30	30
M5	3/16	160	115	30	080080205
M6	1/4	180	160	30	080080206
M8	5/16	210	300	20	080080208
M10	3/8	250	470	15	080080210
M12	1/2	280	690	15	080080212
M14	9/16	340	940	5	080080214
M16	5/8	380	1290	5	080080216
M18	11/16	410	1660	3	080080218
M20	3/4	440	2130	3	080080220
M22	7/8	480	2630	2	080080222
M24	1"	520	3060	2	080080224
M27	1 1/8	560	4000	1	080080227
M30	1 3/16	560	4860	1	080080230
M33	1 1/4	600	6040	1	080080233
M36*	1 3/8	600	6500	1	080080236
M39*	1 1/2	600	7900	1	080080239

Whitworth thread subject to availability

New batches with metric thread

special free service boxes



Ø mm	2	1	080089305
M5	2	1	080089305
M6	2	1	080089306
M8	1	1	080089208
M10	1	1	080089210
M12	1	1	080089212
M14	1	1	080089214

8008TZN

stub and stub turnbuckles,
pipe bodies DIN 1478,
self-coloured terminals, galvanised bodies



TECHNICAL DATA

- safety factor: 4

LABORATORY TESTS

- chemical analysis
- tensile test

AVAILABLE CERTIFICATES

- Product specifications
- Test report type 2.2 UNI EN10204
- CE Declaration of Conformity

Ø mm	≈ "	WFL kg	10	1
M12	1/2	690	10	080080512
M16	5/8	1290	1	080080516
M20	3/4	2130	1	080080520
M24	1	3060	1	080080524
M27	1.1/8	4000	1	080080527
M30	1.3/16	4860	1	080080530
M36	1.3/8	6500	1	080080536

8009Z

jaw and jaw turnbuckles,
galvanized

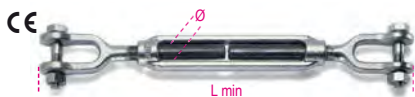

TECHNICAL DATA

- safety coefficient: 4

LABORATORY TESTS

- chemical analysis
- tensile test

AVAILABLE CERTIFICATES

- Technical product specifications
- Test report UNI EN10204 type 2.2
- CE Declaration of Conformity

Ø mm	≈ "	L min mm	WFL kg		
M8	5/16	192	300	15	080090008
M10	3/8	234	470	15	080090010
M12	1/2	274	690	15	080090012
M14	9/16	342	940	1	080090014
M16	5/8	372	1290	1	080090016
M18	11/16	406	1660	1	080090018
M20	3/4	406	2130	1	080090020
M22	7/8	466	2630	1	080090022
M24	1"	486	3060	1	080090024
M27	1 1/8	510	4000	1	080090027
M30	1 3/16	566	4860	1	080090030

special free service boxes



Ø mm			
M8	1	1	080099008
M10	1	1	080099010
M12	1	1	080099012

8009TZ

jaw and jaw turnbuckles,
pipe bodies, DIN 1478
galvanized



TECHNICAL DATA

- safety coefficient: 4

LABORATORY TESTS

- chemical analysis
- tensile test

AVAILABLE CERTIFICATES

- Technical Product Specifications
- Test Report UNI EN10204 type 2.2
- CE Declaration of Conformity

Ø mm	≈ "	WFL kg		
M12	1/2	690	10	080090512
M16	5/8	1290	1	080090516
M20	3/4	2130	1	080090520
M24	1	3060	1	080090524
M27	1.1/8	4000	1	080090527
M30	1.3/16	4860	1	080090530

special free service boxes



Ø mm			
M12	1	1	080099512

8010Z

eye and jaw turnbuckles,
galvanized



TECHNICAL DATA

- safety coefficient: 4

LABORATORY TESTS

- chemical analysis
- tensile test

AVAILABLE CERTIFICATES

- Technical product specifications
- Test report UNI EN10204 type 2.2
- CE Declaration of Conformity

Ø mm	≈ "	L min mm	WFL kg		
M8	5/16	175	300	20	080100008
M10	3/8	215	470	15	080100010
M12	1/2	250	690	10	080100012
M14	9/16	299	940	10	080100014
M16	5/8	331	1290	1	080100016
M18	11/16	382	1660	1	080100018
M20	3/4	382	2130	1	080100020
M22	7/8	433	2630	1	080100022
M24	1"	461	3060	1	080100024
M27	1 1/8	492	4000	1	080100027
M30	1 3/16	529	4860	1	080100030

special free service boxes



Ø mm			
M8	1	1	080109008
M10	1	1	080109010
M12	1	1	080109012
M14	1	1	080109014

8010TZ

eye and jaw turnbuckles,
pipe bodies DIN 1478,
galvanized



TECHNICAL DATA

- safety factor: 4

LABORATORY TESTS • chemical analysis

- tensile test

AVAILABLE CERTIFICATES

- Production specifications
- Test report type 2.2 UNI EN10204
- CE Declaration of Conformity

Ø mm	≈ "	WFL kg		
M12	1/2	690	10	080100612
M16	5/8	1290	1	080100616
M20	3/4	2130	1	080100620
M24	1	3060	1	080100624
M27	1.1/8	4000	1	080100627
M30	1.3/16	4860	1	080100630

8001Z

turnbuckle bodies,
galvanized



TECHNICAL DATA

- safety factor: 4

- traceability code

LABORATORY TESTS

- chemical analysis
- tensile test

AVAILABLE CERTIFICATES

- Technical product specifications
- Test report UNI EN10204 type 2.2
- CE Declaration of Conformity

Ø mm	≈ "	L mm	WFL kg		
M5	3/16	80	115	100	080010105
M6	1/4	80	160	100	080010106
M8	5/16	105	300	25	080010108
M10	3/8	125	470	20	080010110
M11	7/16	135	580	15	080010111
M12	1/2	140	690	20	080010112
M14	9/16	170	940	15	080010114
M16	5/8	190	1290	15	080010116
M18	11/16	205	1660	10	080010118
M20	3/4	220	2130	10	080010120
M22	7/8	240	2630	8	080010122
M24	1"	260	3060	5	080010124
M27	1 1/8	270	4000	1	080010127
M30	1 3/16	280	4860	1	080010130
M33	1 1/4	290	6040	1	080010133
M36	1 3/8	300	6500	1	080010138
M39	1 1/2	300	7900	1	080010199

Whitworth thread subject to availability

New batches with metric thread

special free service boxes



Ø mm			
M5	2	1	080019305
M6	2	1	080019306
M8	1	1	080019108
M10	1	1	080019110
M11	1	1	080019111
M12	1	1	080019112
M14	1	1	080019114
M16	1	1	080019116
M18	1	1	080019118
M20	1	1	080019120
M22	1	1	080019122
M24	1	1	080019124

 **Robur**

8001TZ

pipe turnbuckle bodies,
galvanized

CE



DIN 1478

TECHNICAL DATA

- safety factor: 4
- traceability code

LABORATORY TESTS

- chemical analysis
- tensile test

AVAILABLE CERTIFICATES

- Technical product specifications
- Test report UNI EN10204 type 2.2
- CE Declaration of Conformity

Ø mm	≈ "	L mm	WFL kg		
M12	1/2	125	690	10	080010512
M16	5/8	170	1290	5	080010516
M20	3/4	200	2130	5	080010520
M24	1	255	3060	3	080010524
* M27	1.1/8	255	4000	1	080010527
M30	1.3/16	255	4860	1	080010530
M36	1.3/8	295	6500	1	080010536
M42	1.5/8	330	9700	1	080010542

* Sizes not contemplated by the standard

special free service boxes



Ø mm					
M12	1	1	080019512		
M16	1	1	080019516		
M20	1	1	080019520		
M24	1	1	080019524		

8002ZD

turnbuckle eyes
right thread, galvanized



TECHNICAL DATA

- safety factor: 4
- chemical analysis
- tensile test

AVAILABLE CERTIFICATES

- Technical product specifications
- Test report UNI EN10204 type 2.2

Ø mm	≈ "	E mm	WFL kg		
M5	3/16	37	115	200	080020105
M6	1/4	40	160	150	080020106
M8	5/16	52	300	100	080020108
M10	3/8	60	470	100	080020110
M11	7/16	65	580	1	080020111
M12	1/2	72	690	50	080020112
M14	9/16	85	940	1	080020114
M16	5/8	95	1290	1	080020116
M18	11/16	103	1660	1	080020118
M20	3/4	110	2130	1	080020120
M22	7/8	120	2630	1	080020122
M24	1"	130	3060	1	080020124
M27	1.1/8	135	4000	1	080020127
M30	1.3/16	140	4860	1	080020130
M33	1.1/4	148	6040	1	080020133
M36	1.3/8	150	6500	1	080020136
M39	1.1/2	150	7900	1	080020139

Whitworth thread subject to availability
New batches with metric thread

left-handed thread

Ø mm	≈ "	E mm	WFL kg		
M5	3/16	37	115	1	080020305
M6	1/4	40	160	1	080020306
M8	5/16	52	300	1	080020308
M10	3/8	60	470	1	080020310
M11	7/16	65	580	1	080020311
M12	1/2	72	690	1	080020312
M14	9/16	85	940	1	080020314
M16	5/8	95	1290	1	080020316
M18	11/16	103	1660	1	080020318
M20	3/4	110	2130	1	080020320
M22	7/8	120	2630	1	080020322
M24	1"	130	3060	1	080020324
M27	1.1/8	135	4000	1	080020327
M30	1.3/16	140	4860	1	080020330
M33	1.1/4	148	6040	1	080020333
M36	1.3/8	150	6500	1	080020336
M39	1.1/2	150	7900	1	080020339

8003ZD

turnbuckle hooks
right thread, galvanized



TECHNICAL DATA

- safety factor: 4
- chemical analysis
- tensile test

AVAILABLE CERTIFICATES

- Technical product specifications
- Test report UNI EN10204 type 2.2

Ø mm	≈ "	E mm	WFL kg		
M5	3/16	40	25	150	080030105
M6	1/4	40	45	120	080030106
M8	5/16	52	95	100	080030108
M10	3/8	60	140	70	080030110
M11	7/16	65	165	1	080030111
M12	1/2	70	300	30	080030112
M14	9/16	85	420	1	080030114
M16	5/8	95	570	1	080030116
M18	11/16	103	700	1	080030118
M20	3/4	110	900	1	080030120
M22	7/8	120	1100	1	080030122
M24	1"	130	1300	1	080030124
M27	1.1/8	135	2300	1	080030127

left-handed thread

Ø mm	≈ "	WFL kg	E mm		
M5	3/16	40	25	1	080030305
M6	1/4	40	45	1	080030306
M8	5/16	52	95	1	080030308
M10	3/8	60	140	1	080030310
M11	7/16	65	165	1	080030311
M12	1/2	70	300	1	080030312
M14	9/16	85	420	1	080030314
M16	5/8	95	570	1	080030316
M18	11/16	103	700	1	080030318
M20	3/4	110	900	1	080030320
M22	7/8	120	1100	1	080030322
M24	1"	130	1300	1	080030324
M27	1.1/8	135	2300	1	080030327

8004ND

turnbuckle stubs
right-handed thread, self-coloured



TECHNICAL DATA

- safety factor: 4
- chemical analysis
- tensile test

AVAILABLE CERTIFICATES

- Technical product specifications
- Test report UNI EN10204 type 2.2

Ø mm	≈ "	E mm	WFL kg		
M5	3/16	40	115	1	080040005
M6	1/4	44	160	1	080040006
M8	5/16	53	300	1	080040008
M10	3/8	63	470	1	080040010
M12	1/2	70	690	1	080040012
M14	9/16	85	940	1	080040014
M16	5/8	95	1290	1	080040016
M18	11/16	103	1660	1	080040018
M20	3/4	110	2130	1	080040020
M22	7/8	120	2630	1	080040022
M24	1"	130	3060	1	080040024
M27	1.1/8	135	4000	1	080040027
M30	1.3/16	140	4860	1	080040030
M33	1.1/4	150	6040	1	080040033
M36	1.3/8	150	6500	1	080040036
M39	1.1/2	150	7900	1	080040039

Whitworth thread subject to availability
New batches with metric thread

left-handed thread

Ø mm	≈ "	E mm	WFL kg		
M5	3/16	40	115	1	080040105
M6	1/4	44	160	1	080040106
M8	5/16	53	300	1	080040108
M10	3/8	63	470	1	080040110
M12	1/2	70	690	1	080040112
M14	9/16	85	940	1	080040114
M16	5/8	95	1290	1	080040116
M18	11/16	103	1660	1	080040118
M20	3/4	110	2130	1	080040120
M22	7/8	120	2630	1	080040122
M24	1"	130	3060	1	080040124
M27	1.1/8	135	4000	1	080040127
M30	1.3/16	140	4860	1	080040130
M33	1.1/4	150	6040	1	080040133
M36	1.3/8	150	6500	1	080040136
M39	1.1/2	150	7900	1	080040139



8009FD

turnbuckle jaws
right-handed thread, galvanized



TECHNICAL DATA

• safety factor: 4

LABORATORY TESTS

• chemical analysis
• tensile test

AVAILABLE CERTIFICATES

• Technical product specifications
• Test report UNI EN10204 type 2.2

Ø mm	≈ "	E mm	WFL kg		
M8	5/16	53	300	1	080090208
M10	3/8	63	470	1	080090210
M12	1/2	70	690	1	080090212
M14	9/16	85	940	1	080090214
M16	5/8	95	1290	1	080090216
M18	11/16	103	1660	1	080090218
M20	3/4	110	2130	1	080090220
M22	7/8	120	2630	1	080090222
M24	1"	130	3060	1	080090224
M27	1 1/8	135	4000	1	080090227
M30	1 3/16	140	4860	1	080090230

left-handed thread

Ø mm	≈ "	E mm	WFL kg		
M8	5/16	53	300	1	080090408
M10	3/8	63	470	1	080090410
M12	1/2	70	690	1	080090412
M14	9/16	85	940	1	080090414
M16	5/8	95	1290	1	080090416
M18	11/16	103	1660	1	080090418
M20	3/4	110	2130	1	080090420
M22	7/8	120	2630	1	080090422
M24	1"	130	3060	1	080090424
M27	1 1/8	135	4000	1	080090427
M30	1 3/16	140	4860	1	080090430

8048

eye tie rods right thread
self-coloured



UNI 6058

ØxL mm	WFL kg	F mm		
M8x50	430	6	1	080480108
M8x65	430	6	1	080480109
M10x80	690	8	1	080480110
M10x100	690	8	1	080480210
M10x130	690	8	1	080480111
M12x70	1020	10	1	080480212
M12x95	1020	10	1	080480112
M12x125	1020	10	1	080480113
M14x110	1420	12	1	080480114
M16x100	1980	14	1	080480115
M16x130	1980	14	1	080480116
M18x150	2390	16	1	080480118
M20x160	3100	18	1	080480120
M22x180	3890	18	1	080480122
M24x200	4460	20	1	080480124
M24x220	4460	20	1	080480125
M27x220	5900	22	1	080480127

8302Z

fastening eye bolts,
right thread, galvanized



TECHNICAL DATA

• safety factor: 4

AVAILABLE CERTIFICATES

• Technical product specifications
• Test report UNI EN10204 type 2.2

Ø mm	E mm	F mm	WFL kg		
M5	48	8	115	200	083020005
M6	55	10	160	150	083020006
M8	60	12	300	100	083020008
M10	73	14	470	100	083020010
M12	90	17	690	50	083020012

8303Z

fastening hooks
right thread, galvanized



TECHNICAL DATA

• safety factor: 4

AVAILABLE CERTIFICATES

• Technical product specifications
• Test report UNI EN10204 type 2.2

Ø mm	C mm	E mm	WFL kg		
M5	6,0	48	25	120	083030005
M6	8,0	55	45	100	083030006
M8	10,0	60	95	75	083030008
M10	12,5	73	140	50	083030010
M12	16,0	90	220	20	083030012

8702N

swage sockets made from forged steel

closed
black



TECHNICAL DATA

• traceability code

LABORATORY TESTS

• chemical analysis
• tensile test

AVAILABLE CERTIFICATES

• Technical product specifications
• Test report UNI EN10204 type 2.2

• Inspection certificate UNI EN10204 type 3.1

M	ø B mm	ø A mm	ø D mm		
6	6,8	13	19	1	087020106
8	8,8	20	22	1	087020108
10	10,8	20	22	1	087020110
11	11,8	25	27	1	087020111
12	12,8	25	27	1	087020112
13	13,8	25	27	1	087020113
14	14,8	32	32	1	087020114
15	15,9	32	32	1	087020115
16	17,0	32	32	1	087020116
18	19,0	39	37	1	087020118
19	20,0	39	37	1	087020119
20	21,1	39	37	1	087020120
24	25,4	50	52	1	087020124
25	26,4	50	52	1	087020125
26	27,4	50	52	1	087020126

Socket swaging requires suitable presses and dies and can only be performed by trained staff.

8709N

swage sockets made from forged steel

open

black



TECHNICAL DATA

• traceability code

LABORATORY TESTS

• chemical analysis
• tensile test

AVAILABLE CERTIFICATES

• Technical product specifications
• Test report UNI EN10204 type 2.2

• Inspection certificate UNI EN10204 type 3.1

M	ø B mm	ø A mm	ø C mm		
6	6,8	13	17	1	087090106
8	8,8	20	21	1	087090108
10	10,8	20	21	1	087090110
11	11,8	25	25	1	087090111
12	12,8	25	25	1	087090112
13	13,8	25	25	1	087090113
14	14,8	32	30	1	087090114
15	15,9	32	30	1	087090115
16	17,0	32	30	1	087090116
18	19,0	39	35	1	087090118
19	20,0	39	35	1	087090119
20	21,1	39	35	1	087090120
24	25,4	50	51	1	087090124
25	26,4	50	51	1	087090125
26	27,4	50	51	1	087090126

Socket swaging requires suitable presses and dies and can only be performed by trained staff.



8016

wire rope clips,
hot forged steel body,
galvanized

CE

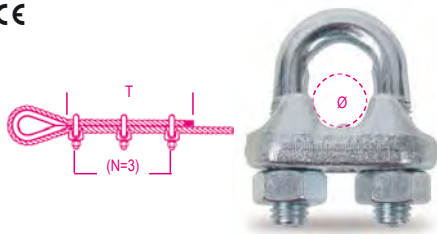

TECHNICAL DATA

- chemical analysis
- torque test

AVAILABLE CERTIFICATES

- Technical product specifications
- Test report UNI EN10204 type 2.2
- CE Certificate of Conformity

Ø mm	Ø "	N x T	Nm		
3	1/8	3x80	1,53	500	080160003
5	3/16	3x110	3,02	300	080160005
6	1/4	3x120	5,19	200	080160006
8	5/16	5x210	5,19	150	080160008
10	3/8	5x240	12,54	70	080160010
11	7/16	5x260	12,54	70	080160011
12-13	1/2	5x300	24,76	40	080160013
14	9/16	5x295	24,76	35	080160014
16	5/8	5x335	24,76	30	080160016
18	11/16	5x380	42,42	30	080160018
20	3/4	5x540	42,42	30	080160020
22	7/8	7x595	42,42	25	080160022
24-26	1"	7x700	67,56	15	080160026
28	1 1/16	8x840	67,56	5	080160028
30-32	1 1/8	8x990	67,56	5	080160030
34-36	1 1/4	8x1155	105,80	4	080160034
38-40	1 1/2	8x1320	105,80	2	080160040
45-50	2"	8x1500	206	1	080160050

special packaging

Ø mm					
3	1/8	100	1	080160703	
5	3/16	50	1	080160705	
6	1/4	50	1	080160706	
8	5/16	30	1	080160708	
10	3/8	30	1	080160710	
11	7/16	25	1	080160711	
12-13	1/2	15	1	080160713	

special free service boxes

Ø mm					
3	6	1	080169403		
5	4	1	080169405		
6	4	1	080169406		
8	4	1	080169408		
10	2	1	080169410		
11	1	1	080169011		
12-13	1	1	080169013		
14	1	1	080169014		
16	1	1	080169016		
18	1	1	080169018		
20	1	1	080169020		
22	1	1	080169022		
24-26	1	1	080169026		

8016DA

wire rope clips with high nuts,
hot forged steel body,
galvanized

CE

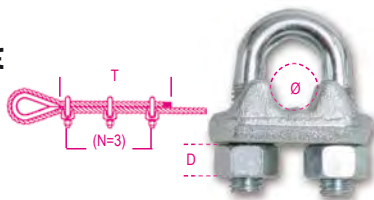

LABORATORY TESTS

- chemical analysis
- torque test

AVAILABLE CERTIFICATES

- Technical product specifications
- Test report UNI EN10204 type 2.2
- CE Certificate of Conformity

Ø mm	N x T	Nm	D mm		
5	3x110	3,02	5	300	080160093
6	3x120	5,19	6	200	080160092
8	5x210	5,19	6	150	080160098
10	5x240	12,54	8	70	080160096

8016FR

wire rope clips,
cold pressed steel body,
galvanized

CE

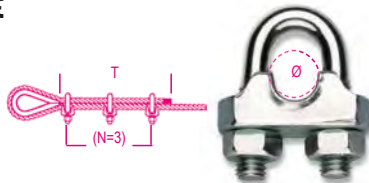

LABORATORY TESTS

- chemical analysis

AVAILABLE CERTIFICATES

- Technical product specifications
- Test report UNI EN10204 type 2.2
- CE Certificate of Conformity

Ø mm	Ø "	N x T	Nm		
3	1/8	3x80	1,25	500	080160253
5	3/16	3x110	2,46	300	080160255
6	1/4	3x120	4,24	200	080160256
8	5/16	5x210	4,24	150	080160258

special free service boxes

Ø mm					
3	6	1	080169753		
5	6	1	080169755		
6	4	1	080169756		
8	4	1	080169758		

8018E

wire rope clips, ENEL type,
hot forged steel body, hot-dip galvanized
U-bolts and nuts with chemical galv. protection



LABORATORY TESTS

- chemical analysis

AVAILABLE CERTIFICATES

- Technical product specifications
- Test report UNI EN10204 type 2.2

Ø mm	A mm	L mm	Nm		
4+6	M6	34	4,24	100	080180001

8016U2

wire rope clips
malleable cast iron body
galvanized

CE

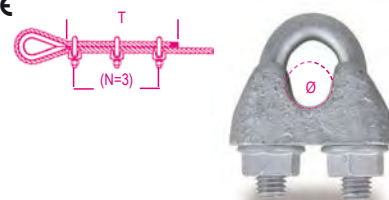

dimensioni EN 13411-5 tipo A

TECHNICAL DATA

- traceability code

LABORATORY TESTS

- chemical analysis
- torque test

AVAILABLE CERTIFICATES

- Technical product specifications
- Test report UNI EN10204 type 2.2
- Manufacturer's Certificate UNI EN13411-5
- CE Certificate of Conformity

Ø mm	Ø "	N x T	Nm		
5	3/16	3x156	2,0	300	080160855
6,5	1/4	3x192	3,5	150	080160856
8	5/16	4x320	6	70	080160858
10	3/8	4x320	9	60	080160860
12	1/2	4x384	20	25	080160862
14	9/16	4x448	33	15	080160864
16	5/8	4x512	49	10	080160866
19	3/4	4x512	68	10	080160869
22	7/8	5x680	107	10	080160872
26	1	5x760	147	5	080160876
30	1.1/8	6x984	212	5	080160880
34	1.1/4	6x1080	296	5	080160884
40	1.1/2	6x1176	363	5	080160890

special free service boxes

Ø mm					
5	4	1	080169805		
6	4	1	080169806		
8	4	1	080169808		
10	2	1	080169810		
12	1	1	080169612		
14	1	1	080169614		
16	1	1	080169616		
19	1	1	080169619		
22	1	1	080169622		
26	1	1	080169626		

8016UGK

wire rope clips,
made of malleable cast iron,
HOT DIP GALVANIZED body,
GEOMET-GEOKOTE U-bolts and nuts

CE

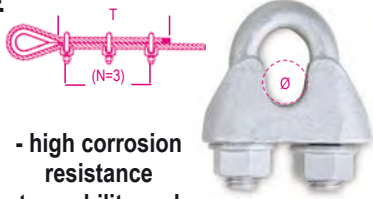

- high corrosion resistance
- traceability code

dimensioni EN 13411-5 tipo A

TECHNICAL DATA

- traceability code
- LABORATORY TESTS
- chemical analysis
- torque test

AVAILABLE CERTIFICATES

- Technical product specifications
- Test report UNI EN10204 type 2.2
- Manufacturer's Certificate UNI EN13411-5
- CE Declaration of conformity

Ø mm	Ø "	N x T	Nm		
8	5/16	4x320	6	70	080160758
10	3/8	4x320	9	60	080160760
12	1/2	4x448	33	25	080160762
14	9/16	4x384	20	15	080160764
16	5/8	4x512	49	10	080160766
19	3/4	4x512	68	10	080160769
22	7/8	5x680	107	10	080160772
26	1	5x760	147	5	080160776
30	1,1/8	6x984	212	1	080160780
34	1,1/4	6x1080	296	1	080160784
40	1,1/2	6x1176	363	1	080160790

8018T

wire rope clips, TELECOM type
malleable cast iron body
galvanized



RUM-MU-21:1980

LABORATORY TESTS

- chemical analysis
- AVAILABLE CERTIFICATES
- Technical product specifications
- Test report UNI EN10204 type 2.2

Ø mm	A mm	L mm	Nm		
8÷10	M8	42	10,20	200	080180003

8020A

thimbles, Italian light type,
galvanized



AVAILABLE CERTIFICATES

- Technical product specifications
- Test report UNI EN10204 type 2.2

Ø mm	F mm	B mm	D mm		
2-3	1,0	20	18	150	080200503
4	1,2	23	19	150	080200504
5	1,2	24	23	100	080200505
6	1,2	27	28	100	080200506
8	1,4	33	32	50	080200508
10	1,8	41	38	30	080200510
12	2,2	44	45	30	080200512
14	2,2	52	49	50	080200514
16	3,0	58	58	50	080200516
18	3,7	64	68	50	080200518
20	3,7	73	74	35	080200520
22	3,7	83	79	30	080200522
24	3,7	93	88	20	080200525

8020

thimbles, italian light type,
galvanized

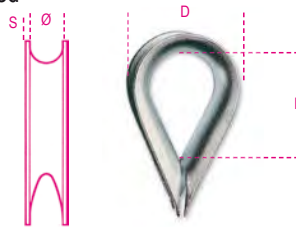

AVAILABLE CERTIFICATES

- Technical product specifications
- Test report UNI EN10204 type 2.2

Ø mm	S mm	B mm	D mm		
2-3	0,8	20	20	350	080200003
4	1,0	22	21	300	080200004
5	1,0	23	24	300	080200005
6	1,0	27	29	200	080200006
8	1,2	33	33	180	080200008
10	1,5	40	39	100	080200010
12	1,8	44	46	120	080200012
14	2,0	49	50	100	080200014
16	2,0	57	59	150	080200016
18	2,5	68	69	100	080200018
20	3,0	78	77	70	080200020
22	3,0	88	84	60	080200022
24	3,5	92	91	40	080200025

special packaging

Ø mm	S mm			
2-3	0,8	150	1	080200703
4	1,0	150	1	080200704
5	1,0	100	1	080200705
6	1,0	100	1	080200706
8	1,2	50	1	080200708
10	1,5	30	1	080200710

8021

thimbles, heavy type,
galvanized

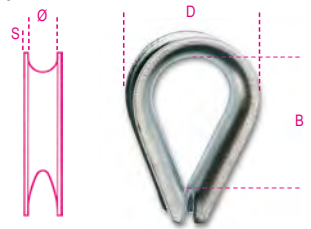

AVAILABLE CERTIFICATES

- Technical product specifications
- Test report UNI EN10204 type 2.2

Ø mm	S mm	B mm	D mm		
2-3	0,6	15	16	150	080210003
5	1,7	29	28	120	080210005
6	1,8	33	30	100	080210006
8	2,5	36	37	100	080210008
10	2,5	42	43	80	080210010
12	2,5	48	50	100	080210012
14	2,7	58	57	70	080210014
16	3,0	61	62	50	080210016
18	3,5	71	71	70	080210018
20	4,0	79	79	60	080210020
22	4,0	87	84	50	080210022
24	4,0	93	92	40	080210024
26	4,0	103	103	35	080210026
28	5,0	107	116	1	080210028
30	5,0	118	121	1	080210030
32	5,5	138	135	1	080210032
35	6,0	140	147	1	080210035
40	6,0	173	170	1	080210040

8026R

straight shackles with screw collar pin,
high-tensile alloy steel, GRADE 6,
hot-dipped galvanized body

CE

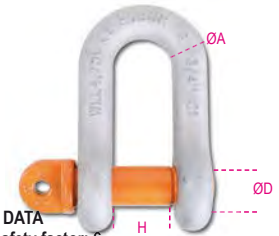

EN 13889
GRADE 6

TECHNICAL DATA

- minimum safety factor: 6
- heat treatment: hardening and tempering
- traceability code on both pin and body
- LABORATORY TESTS

- chemical analysis
- metallographic analysis
- tensile test
- fatigue test (min. 20,000 cycles)
- proof load test (2 x WLL)

AVAILABLE CERTIFICATES

- Technical Product Specifications
- Test Report UNI EN10204 type 2.2
- Inspection Certificate UNI EN10204 type 3.1
- CE Declaration of Conformity

ØD mm	ØA mm	H mm	WLL kg		
16	13	21	2000	5	080260212
19	16	27	3250	3	080260216
22	19	32	4750	2	080260219
25	22	37	6500	2	080260222

special free service boxes

ØD mm				
16	1	1	1	080269212
19	1	1	1	080269216

Robur

8029R

bow shackles with screw collar pins,
high-tensile alloy steel, GRADE 6,
hot-dipped galvanized body

CE



EN 13889
GRADO 6

TECHNICAL DATA

- minimum safety factor: 6
- heat treatment: hardening and tempering
- traceability code on pin and body

LABORATORY TESTS

- chemical analysis
- metallographic analysis
- tensile test
- fatigue test (min. 20,000 cycles)
- proof load test (2 x WLL)

AVAILABLE CERTIFICATES

- Technical Product Specifications
- Test Report UNI EN10204 type 2.2
- Inspection Certificate UNI EN10204 type 3.1
- CE Declaration of Conformity

ØD mm	ØA mm	H mm	WLL kg		
8	6	13	500	20	080290106
10	8	13,5	750	15	080290108
11	10	17	1000	15	080290110
13	11	18,5	1500	10	080290111
16	13	20,5	2000	8	080290112
19	16	27	3250	5	080290116
22	19	32	4750	2	080290120
25	22	37	6500	2	080290122
28	26	43,5	8500	1	080290124
32	29	48	9500	1	080290128
35	32	53	12000	1	080290132
38	35	59	13500	1	080290135
42	38	62	17000	1	080290138
50	45	75	25000	1	080290145
57	50	83	35000	1	080290150
65	57	95	42500	1	080290157
70	65	105	55000	1	080290165

special free service boxes



ØD mm			
8	1	1	080299106
10	1	1	080299108
11	1	1	080299110
13	1	1	080299111
16	1	1	080299112
19	1	1	080299116

Robur

8031R

bow shackles with safety bolt, EN13889
high-tensile alloy steel, GRADE 6,
hot-dip galvanized body

CE



EN 13889
GRADO 6

TECHNICAL DATA

- minimum safety factor: 6
- heat treatment: hardening and tempering
- traceability code on pin and body

LABORATORY TESTS

- chemical analysis
- metallographic analysis
- tensile test
- fatigue test (min. 20,000 cycles)
- proof load test (2 x WLL)

AVAILABLE CERTIFICATES

- Technical Product Specifications
- Test Report UNI EN10204 type 2.2
- Inspection Certificate UNI EN10204 type 3.1
- CE Declaration of Conformity

ØD mm	ØA mm	H mm	WLL kg		
13	11	18	1500	5	080310111
16	13	21	2000	5	080310112
19	16	27	3250	3	080310116
22	19	32	4750	2	080310120
25	22	37	6500	2	080310122
28	26	43	8500	1	080310124
32	29	48	9500	1	080310128
35	32	53	12000	1	080310132
38	35	59	13500	1	080310135
42	38	62	17000	1	080310138
50	45	75	25000	1	080310145
57	50	83	35000	1	080310150
70	65	105	55000	1	080310165
83	75	127	85000	1	080310183

special free service boxes



ØD mm			
16	1	1	080319112
19	1	1	080319116

8032

bow shackles with square sunken hole screw
pin,
high-tensile alloy steel, GRADE 6,
hot-dip galvanized body

CE



GRADE 6

TECHNICAL DATA

- minimum safety factor: 6
- heat treatment: hardening and tempering
- traceability code on pin and body

LABORATORY TESTS

- chemical analysis
- metallographic analysis
- tensile test
- fatigue test (min. 20,000 cycles)
- proof load test (2 x WLL)

AVAILABLE CERTIFICATES

- Technical Product Specifications
- Test Report UNI EN10204 type 2.2
- Inspection Certificate UNI EN10204 type 3.1
- CE Declaration of Conformity

ØD mm	ØA mm	H mm	WLL kg		
16	13	21	2000	5	080320012
19	16	27	3250	3	080320016
22	19	32	4750	2	080320020
25	22	37	6500	2	080320022

special free service boxes



ØD mm			
16	1	1	080329012
19	1	1	080329016

8025

lifting LARGE DEE shackles,
hot forged carbon steel,
galvanized

CE



GRADO 4

TECHNICAL DATA

- safety factor: 5
- heat treatment: normalizing
- traceability code

LABORATORY TESTS

- chemical analysis • metallographic analysis
- tensile test

AVAILABLE CERTIFICATES

- Technical product specifications
- Test report UNI EN10204 type 2.2
- Inspection certificate UNI EN10204 type 3.1
- CE Declaration of Conformity

Ø mm	≈	B x C mm	WLL kg		
5	3/16	21x10	70	250	080250005
6	1/4	25x12	100	250	080250006
8	5/16	33x16	250	150	080250008
10	3/8	42x20	400	180	080250010
11	7/16	46x22	500	130	080250011
12	1/2	50x24	600	100	080250012
14	9/16	57x28	800	70	080250014
16	5/8	61x32	1000	10	080250016
18	11/16	65x36	1300	10	080250018
20	3/4	70x40	1600	10	080250020
22	7/8	74x44	2000	10	080250022
25	1"	80x48	2800	2	080250025

special packaging

Ø mm	"			
5	3/16	25	1	080250705
6	1/4	25	1	080250706
8	5/16	25	1	080250708
10	3/8	15	1	080250710
11	7/16	12	1	080250711
12	1/2	12	1	080250712
14	9/16	10	1	080250714

special free service boxes



Ø mm				
5	4	1	080259205	
6	4	1	080259206	
8	2	1	080259208	
10	2	1	080259210	
11	1	1	080259011	
12	1	1	080259012	
14	1	1	080259014	
16	1	1	080259016	
18	1	1	080259018	
20	1	1	080259020	
22	1	1	080259022	
25	1	1	080259025	

8026A

lifting DEE shackles,
hot forged carbon steel,
UNI 1947 type A, galvanized

CE

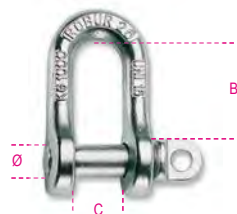

GRADO 4

TECHNICAL DATA

- safety factor: 5
 - heat treatment: normalizing
 - traceability code
- LABORATORY TESTS
- chemical analysis
 - metallographic analysis
 - tensile test
- AVAILABLE CERTIFICATES
- Technical product specifications
 - Test report UNI EN10204 type 2.2
 - Inspection certificate UNI EN10204 type 3.1
 - CE Declaration of Conformity

Ø mm	"	B x C mm	WLL kg		
12	1/2	42x20	630	35	080260012
14	9/16	46x22	800	30	080260014
16	5/8	50x24	1000	20	080260016
18	11/16	54x26	1300	15	080260018
20	3/4	58x28	1600	10	080260020
22	7/8	69x32	2000	10	080260022
25	1"	79x36	2500	5	080260025
28	1.1/8	90x40	3150	2	080260028
32	1.1/4	100x45	4000	1	080260032
36	1.3/8	110x50	5000	1	080260036
40	1.9/16	120x55	6300	1	080260040
42	1.5/8	131x60	8000	1	080260042
45	1.3/4	143x65	10000	1	080260045
50	2"	155x70	12500	1	080260050

special free service boxes



Ø mm				
12	1	1	080269012	
14	1	1	080269014	
16	1	1	080269016	
18	1	1	080269018	
20	1	1	080269020	
22	1	1	080269022	
25	1	1	080269025	



8028

lifting BOW shackles,
hot forged carbon steel,
galvanized

CE

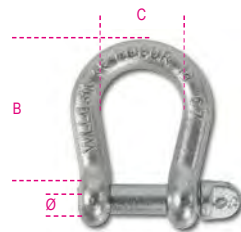

GRADO 4

TECHNICAL DATA

- safety factor: 5
 - heat treatment: normalizing
 - traceability code
- LABORATORY TESTS
- chemical analysis
 - metallographic analysis
 - tensile test
- AVAILABLE CERTIFICATES
- Technical product specifications
 - Test report UNI EN10204 type 2.2
 - Inspection certificate UNI EN10204 type 3.1
 - CE Declaration of Conformity

Ø mm	"	B x C mm	WLL kg		
5	3/16	20x16	80	100	080280105
6	1/4	24x20	100	70	080280106
8	5/16	32x24	200	35	080280108
10	3/8	40x33	300	25	080280110
12	1/2	48x39	500	15	080280112
14	9/16	56x46	600	7	080280114
16	5/8	64x46	800	10	080280116
18	11/16	71x59	950	5	080280118
20	3/4	80x65	1100	5	080280120
22	7/8	88x72	1500	5	080280122
25	1"	100x81	2000	2	080280125
28	1.1/8	112x91	2600	1	080280128
32	1.1/4	128x104	3200	1	080280132
38	1.1/2	152x124	4500	1	080280138

special free service boxes



Ø mm				
5	4	1	080289305	
6	4	1	080289306	
8	2	1	080289308	
10	2	1	080289310	
12	1	1	080289112	
14	1	1	080289114	
16	1	1	080289116	
18	1	1	080289118	
20	1	1	080289120	
22	1	1	080289122	

8049 WLL (t)

	A°	M8	M10	M12	M16	M20	M24	M30
	0°	0,3	0,6	1	1,6	2,5	4	6,3
	90°	0,6	1,2	2	3,2	5	8	12,6
	90°	0,3	0,6	1	1,6	2,5	4	6,3
	90°	0,6	1,2	2	3,2	5	8	12,6
	0°/45°	0,4	0,8	1,4	2,2	3,5	5,6	8,8
	46°/60°	0,3	0,6	1	1,6	2,5	4	6,3
	0°/45°	0,6	1,3	2,1	3,4	5,3	8,4	13,2
	46°/60°	0,3	0,6	1	1,6	2,3	4	6,3

8049

adjustable lifting eyebolts,
double swivel ring,
high-tensile alloy steel

CE

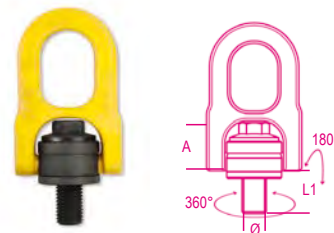







TECHNICAL DATA

- safety factor: 5
 - heat treatment: hardening and tempering
 - traceability code
- LABORATORY TESTS
- chemical analysis
 - metallographic analysis
 - tensile test
 - fatigue test (20,000 cycles)
- AVAILABLE CERTIFICATES
- Technical product specifications
 - Test report UNI EN10204 type 2.2
 - Inspection certificate UNI EN10204 type 3.1
 - CE Declaration of Conformity

Ø mm	A mm	L1 mm	WLL kg		
M8	31,5	14	300	1	080490008
M10	31,5	17	600	1	080490010
M12	31,5	21	1000	1	080490012
M16	45	27	1600	1	080490016
M20	45	30	2500	1	080490020
M24	60,5	36	4000	1	080490024
M30	60,5	45	6300	1	080490030



8049A WLL (t)								
	β (°)	M8	M10	M12	M16	M20	M24	M30
	0	600	900	1000	2000	4000	6300	10600
	0	1200	1800	2000	4000	8000	12600	21200
	90	300	450	500	1120	2000	3150	5300
	90	600	900	1000	2240	4000	6300	10600
	0-45	400	600	700	1400	2800	4250	7100
	45-60	300	400	500	1000	2000	3150	5300
	0-45	600	900	1000	2100	4200	6300	11200
	45-60	400	600	750	1500	3000	4750	8000

8049A

lifting eyebolts,
double swivel ring, turnable under load,
with welded ring,
high-tensile alloy steel

CE



TECHNICAL DATA



- safety factor: 4
- heat treatment: hardening

LABORATORY TESTS

- chemical analysis
- metallographic analysis
- tensile test
- fatigue test (20,000 cycles)
- testing load (100% of batch)

AVAILABLE CERTIFICATES

- Technical product specifications
- Test report UNI EN10204 type 2.2
- Inspection certificate UNI EN10204 type 3.1
- CE Declaration of Conformity

\emptyset mm	E mm	A mm	WLL kg		
* M8	13	30	300	1	080490108
* M10	19	30	450	1	080490110
* M12	19	30	500	1	080490112
* M16	20	30	1120	1	080490116
* M20	30	40	2000	1	080490120
* M24	30	40	3150	1	080490124
* M30	35	50	5300	1	080490130

Robur

8041

lifting eyebolts,
high-tensile alloy steel

CE



TECHNICAL DATA



- safety factor: 4
- heat treatment: hardening and tempering

LABORATORY TESTS

- chemical analysis
- metallographic analysis
- tensile test
- fatigue test (20,000 cycles)
- proof load test (100% of batch)

AVAILABLE CERTIFICATES

- Technical product specifications
- Test report UNI EN10204 type 2.2
- Inspection certificate UNI EN10204 type 3.1
- CE Declaration of Conformity

\emptyset mm	$\frac{E}{A}$ mm	E mm	WLL kg		
* M8	1,25	13	800	10	080410208
* M10	1,5	17	1000	6	080410210
* M12	1,75	20,5	1600	4	080410212
* M16	2	27	3200	2	080410216
* M20	2,5	30	4800	2	080410220
* M24	3	36	6500	2	080410224
* M30	3,5	45	12000	1	080410230

(* Dimensional specifications DIN 580:2010

WLL increased according to Robur Technical Product Specifications

special free service boxes

\emptyset mm			
* M8	1	1	080419208
* M10	1	1	080419210
* M12	1	1	080419212

8043

lifting eye nuts,
high-tensile alloy steel

CE

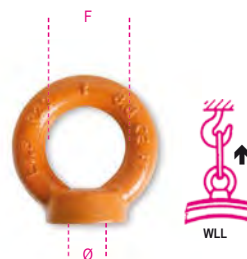

TECHNICAL DATA



- safety factor: 4
- heat treatment: hardening and tempering
- traceability code

LABORATORY TESTS

- chemical analysis
- metallographic analysis
- tensile test
- fatigue test (20,000 cycles)
- proof load test (100% of batch)

AVAILABLE CERTIFICATES

- Technical product specifications
- Test report UNI EN10204 type 2.2
- Inspection certificate UNI EN10204 type 3.1
- CE Declaration of Conformity

\emptyset mm					
* M8	1,25	20	800	10	080430208
* M10	1,50	25	1000	6	080430210
* M12	1,75	30	1600	4	080430212
* M16	2	35	3200	2	080430216
* M20	2,5	40	4800	2	080430220
* M24	3	50	6500	2	080430224
* M30	3,5	60	12000	1	080430230

(* Dimensional specifications DIN 582:2010

WLL increased according to Robur Technical Product Specifications

special free service boxes



\emptyset mm			
* M8	1	1	080439208
* M10	1	1	080439210
* M12	1	1	080439212

Robur

Robur

8040EZ

lifting eye bolts, DIN 580
galvanized

CE



DIN 580:2010-09

TECHNICAL DATA

- safety factor: 6
- heat treatment: normalizing
- traceability code

LABORATORY TESTS

- chemical analysis
- metallographic analysis
- tensile test

AVAILABLE CERTIFICATES

- Technical product specifications
- Test report UNI EN10204 type 2.2
- Inspection certificate UNI EN10204 type 3.1
- CE Declaration of Conformity

Ø mm	WLL mm	E mm	WLL kg		
* M6	1	11	90	60	080400406
M8	1,25	13	140	60	080400408
M10	1,5	17	230	40	080400410
M12	1,75	20,5	340	20	080400412
* M14	2	20,5	480	20	080400414
M16	2	27	700	10	080400416
* M18	2,5	27	930	10	080400418
M20	2,5	30	1200	10	080400420
* M22	2,5	30	1450	10	080400422
M24	3	36	1800	5	080400424
* M27	3	41	2400	5	080400427
M30	3,5	45	3200	2	080400430
* M33	3,5	54	3900	2	080400433
* M33F	2	54	3900	2	080400434
M36	4	54	4600	2	080400436
* M36F	3	54	4600	2	080400437
M42	4,5	63	6300	1	080400442
* M42F	3	63	6300	1	080400443
M48	5	68	8600	1	080400448
* M48F	3	68	8600	1	080400449
M56	5,5	78	11500	1	080400456
* M56F	4	78	11500	1	080400457
M64	6	90	16000	1	080400464
* M64F	4	90	16000	1	080400465

*Sizes not included in DIN standard

special free service boxes



Ø mm			
M6	4	1	080409606
M8	4	1	080409608
M10	2	1	080409610
M12	1	1	080409412
* M14	1	1	080409414
M16	1	1	080409416
* M18	1	1	080409418
M20	1	1	080409420
* M22	1	1	080409422
M24	1	1	080409424
* M27	1	1	080409427
M30	1	1	080409430

8040EN

lifting eye bolts, DIN 580
self-coloured

CE



DIN 580:2010-09

TECHNICAL DATA

- safety factor: 6
- heat treatment: normalizing
- traceability code

LABORATORY TESTS

- chemical analysis
- metallographic analysis
- tensile test

AVAILABLE CERTIFICATES

- Technical product specifications
- Test report UNI EN10204 type 2.2
- Inspection certificate UNI EN10204 type 3.1
- CE Declaration of Conformity

Ø mm	WLL mm	E mm	WLL kg		
* M6	1	11	90	60	080400306
M8	1,25	13	140	60	080400308
M10	1,5	17	230	40	080400310
M12	1,75	20,5	340	20	080400312
* M14	2	20,5	480	20	080400314
M16	2	27	700	10	080400316
* M18	2,5	27	930	10	080400318
M20	2,5	30	1200	10	080400320
* M22	2,5	30	1450	10	080400322
M24	3	36	1800	5	080400324
* M27	3	41	2400	5	080400327
M30	3,5	45	3200	2	080400330
* M33	3,5	54	3900	2	080400333
* M33F	2	54	3900	2	080400334
M36	4	54	4600	2	080400336
* M36F	3	54	4600	2	080400337
M42	4,5	63	6300	1	080400342
* M42F	3	63	6300	1	080400343
M48	5	68	8600	1	080400348
* M48F	3	68	8600	1	080400349
M56	5,5	78	11500	1	080400356
* M56F	4	78	11500	1	080400357
M64	6	90	16000	1	080400364
* M64F	4	90	16000	1	080400365

*Sizes not included in DIN standard

special free service boxes



Ø mm			
M6	4	1	080409506
M8	4	1	080409508
M10	2	1	080409510
M12	1	1	080409312
* M14	1	1	080409314
M16	1	1	080409316
* M18	1	1	080409318
M20	1	1	080409320
* M22	1	1	080409322
M24	1	1	080409324
* M27	1	1	080409327
M30	1	1	080409330

8042EN

lifting eye nuts, DIN 582
self-coloured

CE

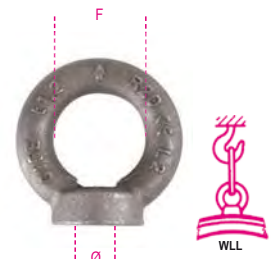

DIN 582:2010-09

TECHNICAL DATA

- safety factor: 6
- heat treatment: normalizing
- traceability code

LABORATORY TESTS

- chemical analysis
- metallographic analysis
- tensile test

AVAILABLE CERTIFICATES

- Technical product specifications
- Test report UNI EN10204 type 2.2
- Inspection certificate UNI EN10204 type 3.1
- CE Declaration of Conformity

Ø mm	WLL mm	F mm	WLL kg		
* M6	1	14	90	60	080420306
M8	1,25	20	140	60	080420308
M10	1,5	25	230	40	080420310
M12	1,75	30	340	30	080420312
* M14	2	30	480	30	080420314
M16	2	35	700	20	080420316
* M18	2,5	35	930	20	080420318
M20	2,5	40	1200	10	080420320
* M22	2,5	40	1450	10	080420322
M24	3	50	1800	5	080420324
* M27	3	55	2400	5	080420327
M30	3,5	60	3200	3	080420330
M36	4	70	4600	2	080420336
* M36F	3	70	4600	2	080420337
M42	4,5	80	6300	1	080420342
* M42F	3	80	6300	1	080420343
M48	5	90	8600	1	080420348
* M48F	3	90	8600	1	080420349

*Sizes not included in DIN standard

special free service boxes



Ø mm			
M6	4	1	080429506
M8	4	1	080429508
M10	2	1	080429510
M12	1	1	080429312
* M14	1	1	080429314
M16	1	1	080429316
* M18	1	1	080429318
M20	1	1	080429320
* M22	1	1	080429322
M24	1	1	080429324
* M27	1	1	080429327
M30	1	1	080429330



8042EZ

lifting eye nuts, DIN 582
galvanized

CE

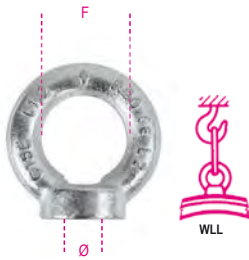

DIN 582:2010-09

TECHNICAL DATA

- safety factor: 6
- heat treatment: normalizing
- traceability code

LABORATORY TESTS

- chemical analysis
- metallographic analysis
- tensile test

AVAILABLE CERTIFICATES

- Technical product specifications
- Test report UNI EN10204 type 2.2
- Inspection certificate UNI EN10204 type 3.1
- CE Declaration of Conformity

Ø mm	F mm	WLL kg	60	80
* M6	14	90	60	080420406
M8	20	140	60	080420408
M10	25	230	40	080420410
M12	30	340	30	080420412
* M14	30	480	30	080420414
M16	35	700	20	080420416
* M18	35	930	20	080420418
M20	40	1200	10	080420420
* M22	40	1450	10	080420422
M24	50	1800	5	080420424
* M27	55	2400	5	080420427
M30	60	3200	3	080420430
M36	70	4600	2	080420436
* M36F	70	4600	2	080420437
M42	80	6300	1	080420442
* M42F	80	6300	1	080420443
M48	90	8600	1	080420448
* M48F	90	8600	1	080420449

*Sizes not included in DIN standard

special free service boxes



Ø mm	1	804
M6	4	1 080429606
M8	4	1 080429608
M10	2	1 080429610
M12	1	1 080429412
* M14	1	1 080429414
M16	1	1 080429416
* M18	1	1 080429418
M20	1	1 080429420
* M22	1	1 080429422
M24	1	1 080429424
* M27	1	1 080429427
M30	1	1 080429430

8044

lifting eye nuts, UNI 2948
self-coloured

CE



UNI 2948

TECHNICAL DATA

- safety factor: 4
- heat treatment: normalizing
- traceability code

LABORATORY TESTS

- chemical analysis
- metallographic analysis
- tensile test

AVAILABLE CERTIFICATES

- Technical product specifications
- Test report UNI EN10204 type 2.2
- Inspection certificate UNI EN10204 type 3.1
- CE Declaration of Conformity

Ø mm	F mm	WLL kg	4	80
M8	1,25	80	4	080440008
M10	1,5	160	4	080440010
M12	1,75	250	4	080440012
M14	2	250	2	080440014
M16	2	400	2	080440016
M20	2,5	630	2	080440020
M24	3	1000	2	080440024



CHAIN SLINGS Grade 8

Ø D mm	WLL Ton		UNI EN 818
	0° < β ≤ 45°	45° < β ≤ 60°	
6	1,12	1,6	1,12
7	1,5	2,12	1,5
8	2	2,8	2
10	3,15	4,25	3,15
13	5,3	7,5	5,3
16	8	11,2	8
Ø D mm	WLL 3		UNI EN 818
	0° < β ≤ 45°	45° < β ≤ 60°	
6	2,36	1,7	
7	3,15	2,24	
8	4,25	3	
10	6,7	4,75	
13	11,2	8	
16	17	11,2	

8091

lifting chain slings, 1 leg
grade 8

CE

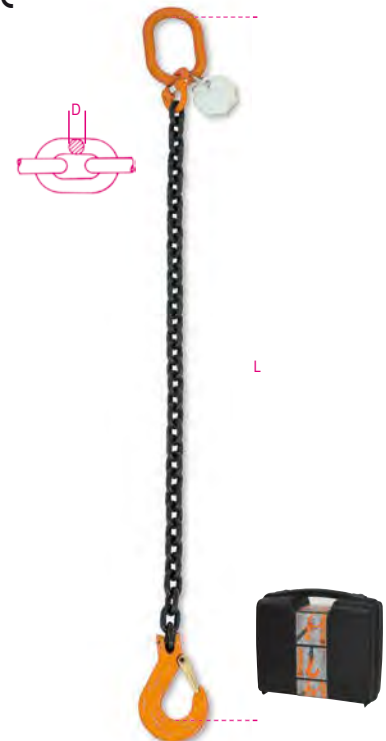

UNI EN 818-4

TECHNICAL DATA

- safety factor: 4
 - chain-sling identification tag
- ### ATTACHED CERTIFICATES
- Manufacturer's Certificate UNI EN818-4
 - CE Declaration of Conformity
- ### AVAILABLE CERTIFICATES
- Technical product specifications

Ø D mm	L m	WLL ton	1	80
6*	1	1,12	1	080910001
6*	2	1,12	1	080910002
6*	3	1,12	1	080910003
6*	4	1,12	1	080910004
7*	1	1,5	1	080910021
7*	2	1,5	1	080910022
7*	3	1,5	1	080910023
7*	4	1,5	1	080910024
8*	1	2	1	080910041
8*	2	2	1	080910042
8*	3	2	1	080910043
8*	4	2	1	080910044
10*	1	3,15	1	080910051
10*	2	3,15	1	080910052
10*	3	3,15	1	080910053
10*	4	3,15	1	080910054
13*	1	5,3	1	080910131
13*	2	5,3	1	080910132
13*	3	5,3	1	080910133
13*	4	5,3	1	080910134
16*	1	8	1	080910161
16*	2	8	1	080910162
16*	3	8	1	080910163
16*	4	8	1	080910164

* packed in plastic case

8091SL

lifting chain slings,
1 leg, self-locking hook,
grade 8

CE



UNI EN 818-4

TECHNICAL DATA

- safety factor: 4
 - chain-sling identification tag
- ATTACHED CERTIFICATES**
- Manufacturer's Certificate UNI EN818-4
 - CE Declaration of Conformity
- AVAILABLE CERTIFICATES**
- Technical product specifications

D mm	L m	WLL ton		
6*	1	1,12	1	080910201
6*	2	1,12	1	080910202
6*	3	1,12	1	080910203
6*	4	1,12	1	080910204
7*	1	1,5	1	080910221
7*	2	1,5	1	080910222
7*	3	1,5	1	080910223
7*	4	1,5	1	080910224
8*	1	2	1	080910241
8*	2	2	1	080910242
8*	3	2	1	080910243
8*	4	2	1	080910244
10*	1	3,15	1	080910251
10*	2	3,15	1	080910252
10*	3	3,15	1	080910253
10*	4	3,15	1	080910254
13*	1	5,3	1	080910331
13*	2	5,3	1	080910332
13*	3	5,3	1	080910333
13*	4	5,3	1	080910334
16*	1	8	1	080910361
16*	2	8	1	080910362
16*	3	8	1	080910363
16*	4	8	1	080910364

* Packed in plastic case

8092

lifting chains sling, 2 legs
grade 8

CE



UNI EN 818-4

TECHNICAL DATA

- safety factor: 4
 - chain-sling identification tag
- ATTACHED CERTIFICATES**
- Manufacturer's Certificate UNI EN818-4
 - CE Declaration of Conformity
- AVAILABLE CERTIFICATES**
- Technical product specifications

D mm	L m	WLL ton		
6*	1	1,6	1	080920001
6*	2	1,6	1	080920002
6*	3	1,6	1	080920003
6*	4	1,6	1	080920004
7*	1	2,12	1	080920021
7*	2	2,12	1	080920022
7*	3	2,12	1	080920023
7*	4	2,12	1	080920024
8*	1	2,8	1	080920041
8*	2	2,8	1	080920042
8*	3	2,8	1	080920043
8*	4	2,8	1	080920044
10*	1	4,25	1	080920051
10*	2	4,25	1	080920052
10*	3	4,25	1	080920053
10*	4	4,25	1	080920054
13*	1	7,5	1	080920131
13*	2	7,5	1	080920132
13	3	7,5	1	080920133
13	4	7,5	1	080920134
16*	1	11,2	1	080920161
16	2	11,2	1	080920162
16	3	11,2	1	080920163
16	4	11,2	1	080920164

* packed in plastic case

8092SL

lifting chain slings,
2 legs, self-locking hook,
grade 8

CE



UNI EN 818-4

TECHNICAL DATA

- safety factor: 4
 - chain-sling identification tag
- ATTACHED CERTIFICATES**
- Manufacturer's Certificate UNI EN818-4
 - CE Declaration of Conformity
- AVAILABLE CERTIFICATES**
- Technical product specifications

D mm	L m	WLL ton		
6*	1	1,6	1	080920201
6*	2	1,6	1	080920202
6*	3	1,6	1	080920203
6*	4	1,6	1	080920204
7*	1	2,12	1	080920221
7*	2	2,12	1	080920222
7*	3	2,12	1	080920223
7*	4	2,12	1	080920224
8*	1	2,8	1	080920241
8*	2	2,8	1	080920242
8*	3	2,8	1	080920243
8*	4	2,8	1	080920244
10*	1	4,25	1	080920251
10*	2	4,25	1	080920252
10*	3	4,25	1	080920253
10*	4	4,25	1	080920254
13*	1	7,5	1	080920331
13*	2	7,5	1	080920332
13*	3	7,5	1	080920333
13*	4	7,5	1	080920334
16*	1	11,2	1	080920361
16*	2	11,2	1	080920362
16*	3	11,2	1	080920363
16*	4	11,2	1	080920364

* Packed in plastic case

8094

lifting chain sling, 4 legs
grade 8

CE



UNI EN 818-4

TECHNICAL DATA

- safety factor: 4
 - chain-sling identification tag
- ATTACHED CERTIFICATES**
- Manufacturer's Certificate UNI EN818-4
 - CE Declaration of Conformity
- AVAILABLE CERTIFICATES**
- Technical product specifications

D mm	L m	WLL ton	
6*	1	2,36	1 080940001
6*	2	2,36	1 080940002
6*	3	2,36	1 080940003
6*	4	2,36	1 080940004
7*	1	3,15	1 080940021
7*	2	3,15	1 080940022
7*	3	3,15	1 080940023
7*	4	3,15	1 080940024
8*	1	4,25	1 080940041
8*	2	4,25	1 080940042
8*	3	4,25	1 080940043
8	4	4,25	1 080940044
10*	1	6,7	1 080940051
10	2	6,7	1 080940052
10	3	6,7	1 080940053
10	4	6,7	1 080940054
13	1	11,2	1 080940131
13	2	11,2	1 080940132
13	3	11,2	1 080940133
13	4	11,2	1 080940134
16	1	17	1 080940161
16	2	17	1 080940162
16	3	17	1 080940163
16	4	17	1 080940164

* packed in plastic case

8094SL

lifting chain slings,
4 legs, self-locking hook,
grade 8

CE



UNI EN 818-4

TECHNICAL DATA

- safety factor: 4
 - chain-sling identification tag
- ATTACHED CERTIFICATES**
- Manufacturer's Certificate UNI EN818-4
 - CE Declaration of Conformity
- AVAILABLE CERTIFICATES**
- Technical product specifications

D mm	L m	WLL ton	
6*	1	2,36	1 080940201
6*	2	2,36	1 080940202
6*	3	2,36	1 080940203
6*	4	2,36	1 080940204
7*	1	3,15	1 080940221
7*	2	3,15	1 080940222
7*	3	3,15	1 080940223
7*	4	3,15	1 080940224
8*	1	4,25	1 080940241
8*	2	4,25	1 080940242
8*	3	4,25	1 080940243
8	4	4,25	1 080940244
10*	1	6,7	1 080940251
10	2	6,7	1 080940252
10	3	6,7	1 080940253
10	4	6,7	1 080940254
13	1	11,2	1 080940331
13	2	11,2	1 080940332
13	3	11,2	1 080940333
13	4	11,2	1 080940334
16	1	17	1 080940361
16	2	17	1 080940362
16	3	17	1 080940363
16	4	17	1 080940364

* Packed in plastic case

8096

lifting chain sling, 1 leg
with clevis grab hook,
grade 8

CE



UNI EN 818-4

TECHNICAL DATA

- safety factor: 4
 - chain-sling identification tag
- ATTACHED CERTIFICATES**
- Manufacturer's Certificate UNI EN818-4
 - CE Declaration of Conformity
- AVAILABLE CERTIFICATES**
- Technical product specifications

D mm	L m	WLL ton	
6*	1	1,12	1 080960001
6*	2	1,12	1 080960002
6*	3	1,12	1 080960003
6*	4	1,12	1 080960004
7*	1	1,5	1 080960021
7*	2	1,5	1 080960022
7*	3	1,5	1 080960023
7*	4	1,5	1 080960024
8*	1	2	1 080960041
8*	2	2	1 080960042
8*	3	2	1 080960043
8*	4	2	1 080960044
10*	1	3,15	1 080960051
10*	2	3,15	1 080960052
10*	3	3,15	1 080960053
10*	4	3,15	1 080960054
13*	1	5,3	1 080960131
13*	2	5,3	1 080960132
13*	3	5,3	1 080960133
13*	4	5,3	1 080960134
16*	1	8	1 080960161
16*	2	8	1 080960162
16*	3	8	1 080960163
16	4	8	1 080960164

* packed in plastic case

8096SL

lifting chain slings,
1 leg, with self-locking and clevis grab hooks,
grade 8

CE



UNI EN 818-4

TECHNICAL DATA

- safety factor: 4
 - chain-sling identification tag
- ATTACHED CERTIFICATES**
- Manufacturer's Certificate UNI EN818-4
 - CE Declaration of Conformity
- AVAILABLE CERTIFICATES**
- Technical product specifications

D mm	L m	WLL ton		
6*	1	1,12	1	080960201
6*	2	1,12	1	080960202
6*	3	1,12	1	080960203
6*	4	1,12	1	080960204
7*	1	1,5	1	080960221
7*	2	1,5	1	080960222
7*	3	1,5	1	080960223
7*	4	1,5	1	080960224
8*	1	2	1	080960241
8*	2	2	1	080960242
8*	3	2	1	080960243
8*	4	2	1	080960244
10*	1	3,15	1	080960251
10*	2	3,15	1	080960252
10*	3	3,15	1	080960253
10*	4	3,15	1	080960254
13*	1	5,3	1	080960331
13*	2	5,3	1	080960332
13*	3	5,3	1	080960333
13*	4	5,3	1	080960334
16*	1	8	1	080960361
16*	2	8	1	080960362
16*	3	8	1	080960363
16	4	8	1	080960364

* Packed in plastic case

8097

lifting chain sling, 2 legs
with clevis grab hooks,
grade 8

CE



UNI EN 818-4

TECHNICAL DATA

- safety factor: 4
 - chain-sling identification tag
- ATTACHED CERTIFICATES**
- Manufacturer's Certificate UNI EN818-4
 - CE Declaration of Conformity
- AVAILABLE CERTIFICATES**

- Technical product specifications

D mm	L m	WLL ton		
6*	1	1,6	1	080970001
6*	2	1,6	1	080970002
6*	3	1,6	1	080970003
6*	4	1,6	1	080970004
7*	1	2,12	1	080970021
7*	2	2,12	1	080970022
7*	3	2,12	1	080970023
7*	4	2,12	1	080970024
8*	1	2,8	1	080970041
8*	2	2,8	1	080970042
8*	3	2,8	1	080970043
8*	4	2,8	1	080970044
10*	1	4,25	1	080970051
10*	2	4,25	1	080970052
10*	3	4,25	1	080970053
10*	4	4,25	1	080970054
13*	1	7,5	1	080970131
13*	2	7,5	1	080970132
13	3	7,5	1	080970133
13	4	7,5	1	080970134
16	1	11,2	1	080970161
16	2	11,2	1	080970162
16	3	11,2	1	080970163
16	4	11,2	1	080970164

* packed in plastic case

8097SL

lifting chain slings,
2 legs, with self-locking and clevis grab hooks,
grade 8

CE



UNI EN 818-4

TECHNICAL DATA

- safety factor: 4
 - chain-sling identification tag
- ATTACHED CERTIFICATES**
- Manufacturer's Certificate UNI EN818-4
 - CE Declaration of Conformity
- AVAILABLE CERTIFICATES**
- Technical product specifications

D mm	L m	WLL ton		
6*	1	1,6	1	080970201
6*	2	1,6	1	080970202
6*	3	1,6	1	080970203
6*	4	1,6	1	080970204
7*	1	2,12	1	080970221
7*	2	2,12	1	080970222
7*	3	2,12	1	080970223
7*	4	2,12	1	080970224
8*	1	2,8	1	080970241
8*	2	2,8	1	080970242
8*	3	2,8	1	080970243
8*	4	2,8	1	080970244
10*	1	4,25	1	080970251
10*	2	4,25	1	080970252
10*	3	4,25	1	080970253
10*	4	4,25	1	080970254
13*	1	7,5	1	080970331
13*	2	7,5	1	080970332
13	3	7,5	1	080970333
13	4	7,5	1	080970334
16	1	11,2	1	080970361
16	2	11,2	1	080970362
16	3	11,2	1	080970363
16	4	11,2	1	080970364

* Packed in plastic case

8098

lifting chain sling, 4 legs
with clevis grab hooks,
grade 8

CE



UNI EN 818-4

TECHNICAL DATA

- safety factor: 4
 - chain-sling identification tag
- ATTACHED CERTIFICATES**
- Manufacturer's Certificate UNI EN818-4
 - CE Declaration of Conformity
- AVAILABLE CERTIFICATES**
- Technical product specifications

D mm	L m	WLL ton	kg	mm
6*	1	2,36	1	080980001
6*	2	2,36	1	080980002
6*	3	2,36	1	080980003
6*	4	2,36	1	080980004
7*	1	3,15	1	080980021
7*	2	3,15	1	080980022
7*	3	3,15	1	080980023
7*	4	3,15	1	080980024
8*	1	4,25	1	080980041
8*	2	4,25	1	080980042
8*	3	4,25	1	080980043
8	4	4,25	1	080980044
10*	1	6,7	1	080980051
10	2	6,7	1	080980052
10	3	6,7	1	080980053
10	4	6,7	1	080980054
13	1	11,2	1	080980131
13	2	11,2	1	080980132
13	3	11,2	1	080980133
13	4	11,2	1	080980134
16	1	17	1	080980161
16	2	17	1	080980162
16	3	17	1	080980163
16	4	17	1	080980164

* packed in plastic case

8098SL

lifting chain slings,
4 legs, with self-locking and clevis grab hooks,
grade 8

CE



UNI EN 818-4

TECHNICAL DATA

- safety factor: 4
 - chain-sling identification tag
- ATTACHED CERTIFICATES**
- Manufacturer's Certificate UNI EN818-4
 - CE Declaration of Conformity
- AVAILABLE CERTIFICATES**
- Technical product specifications

D mm	L m	WLL ton	kg	mm
6*	1	2,36	1	080980201
6*	2	2,36	1	080980202
6*	3	2,36	1	080980203
6*	4	2,36	1	080980204
7*	1	3,15	1	080980221
7*	2	3,15	1	080980222
7*	3	3,15	1	080980223
7*	4	3,15	1	080980224
8*	1	4,25	1	080980241
8*	2	4,25	1	080980242
8	3	4,25	1	080980243
8*	4	4,25	1	080980244
10*	1	6,7	1	080980251
10	2	6,7	1	080980252
10	3	6,7	1	080980253
10	4	6,7	1	080980254
13	1	11,2	1	080980331
13	2	11,2	1	080980332
13	3	11,2	1	080980333
13	4	11,2	1	080980334
16	1	17	1	080980361
16	2	17	1	080980362
16	3	17	1	080980363
16	4	17	1	080980364

* Packed in plastic case



8085R

lifting master links,
high-tensile alloy steel
WLL relates to use with 1 chain slings.

CE



EN 1677-4
GRADO 8

TECHNICAL DATA

- safety factor: 4
- heat treatment: hardening and tempering
- traceability code

LABORATORY TESTS

- chemical analysis, metallographic analysis
- proof load test (WLL x 2.5)
- tensile test

• fatigue test (min. 20,000 cycles)

AVAILABLE CERTIFICATES

- Technical product specifications
- Test report UNI EN10204 type 2.2
- Inspection certificate UNI EN10204 type 3.1
- CE Declaration of Conformity

	WLL kg	Ø mm	A mm	kg	mm
8085R	1600	7	110	1	080850215
8085R	2120	8	110	1	080850220
8085R	3150	10	135	1	080850232
8085R	5300	13	160	1	080850253

8085 8,0	8000	16	180	1	080850080
8085 11,2	11200	19	200	1	080850190

* If you match it with a chain 6mm in Ø, WLL= 1120 kg

8086

lifting master link assemblies
alloy steel, painted

* WLL means the use with 3 or 4 chain slings
and β angle < 45°.

CE



EN 1677-4

TECHNICAL DATA

- safety factor: 4
- heat treatment: hardening and tempering
- traceability code

LABORATORY TESTS

- chemical analysis, metallographic analysis
- proof load test (WLL x 2.5)
- tensile test

• fatigue test (min. 20,000 cycles)

AVAILABLE CERTIFICATES

- Technical product specifications
- Test report UNI EN10204 type 2.2
- Inspection certificate UNI EN10204 type 3.1
- CE Declaration of Conformity

WLL kg	Ø mm	B mm	C mm	kg	mm
* 3150	7	135	75	1	080860021
4250	8	160	90	1	080860042
6700	10	180	100	1	080860067
11200	13	200	110	1	080860100
17000	16	260	140	1	080860117

*If you match it with a chain 6 mm in Ø, WLL=2360 Kg.

8090R

lifting connecting links
alloy steel, painted

CE

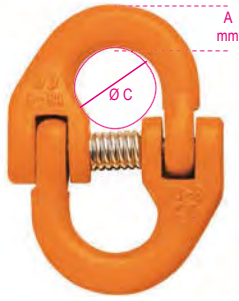

EN 1677-1

TECHNICAL DATA

- safety factor: 4
- heat treatment: hardening and tempering
- traceability code

LABORATORY TESTS

- chemical analysis, metallographic analysis
- proof load test (WLL x 2.5)
- tensile test

- fatigue test (min. 20,000 cycles)

AVAILABLE CERTIFICATES

- Technical product specifications
- Test report UNI EN10204 type 2.2
- Inspection certificate UNI EN10204 type 3.1
- CE Declaration of Conformity

	WLL	Ø C	A	1	
				kg	mm
8090R	6	1120	13	7,5	1 080900111
8090R	7	1500	18	9	1 080900115
8090R	8	2000	18	11	1 080900120
8090R	10	3150	22	13,0	1 080900131
8090R	13	5300	30	16	1 080900153

8090	WLL	Ø C	A	1
kg	mm	mm	mm	
16	8000	32		1 080900080

8060R

Clevis chain hooks,
high-tensile alloy steel

CE



EN 1677-2

TECHNICAL DATA

- safety coefficient: 4
- heat treatment: hardening and tempering
- Traceability code on pin, safety latch, body

LABORATORY TESTS

- chemical analysis, metallographic analysis
- proof load test (WLL x 2.5)
- tensile test

- fatigue test (min. 20,000 cycles)

AVAILABLE CERTIFICATES

- Technical Product Specifications
- Test Report UNI EN10204 type 2.2
- Inspection Certificate UNI EN10204 type 3.1
- CE Declaration of Conformity

	WLL	C	1	
			kg	mm
8060R	1120	6	19	1 080600111
8060R	1500	7	19	1 080600115
8060R	2000	8	21	1 080600120
8060R	3150	10	27	1 080600132
8060R	5300	13	35	1 080600153

8060	WLL	C	1
kg	mm	mm	
8000	16	48	1 080600080

8058R

self-locking lifting hooks,
Clevis type,
high-tensile alloy steel

CE



EN 1677-3

TECHNICAL DATA

- safety factor: 4
- heat treatment: hardening and tempering
- traceability code

LABORATORY TESTS

- chemical analysis, metallographic analysis
- tensile test

- fatigue test (min. 20,000 cycles)

- proof load test (100% of batch)

AVAILABLE CERTIFICATES

- Technical product specifications
- Test report UNI EN10204 type 2.2
- Inspection certificate UNI EN10204 type 3.1
- CE Declaration of Conformity

	WLL	J min	1	
			kg	mm
8058R	1120	6	28	1 080580112
8058R	2000	7-8	34	1 080580120
8058R	3150	10	44	1 080580132
8058R	5300	13	52	1 080580153

8058	WLL	J min	1
kg	mm	mm	
8000	16	67	1 080580080

8061R

Clevis grab hooks
with safety latch,
high-tensile alloy steel

CE



EN 1677-1

TECHNICAL DATA

- safety factor: 4
- heat treatment: hardening and tempering
- traceability code

LABORATORY TESTS

- chemical analysis, metallographic analysis
- tensile test

- fatigue test (min. 20,000 cycles)

- proof load test (100% of batch)

AVAILABLE CERTIFICATES

- Technical product specifications
- Test report UNI EN10204 type 2.2
- Inspection certificate UNI EN10204 type 3.1
- CE Declaration of Conformity

	WLL	E	1	
			kg	mm
8061R	1120	6	8	1 080610211
8061R	2000	7-8	11	1 080610220
8061R	3150	10	13	1 080610231
8061R	5300	13	17	1 080610253

8061F	WLL	E	1
kg	mm	mm	
8000	16	20	1 080610180

8052

wire rope eye hooks,
high-tensile alloy steel

CE



EN 1677-2

TECHNICAL DATA

- safety factor: 4
- heat treatment: hardening and tempering
- traceability code

LABORATORY TESTS

- chemical analysis, metallographic analysis
- tensile test

- fatigue test (min. 20,000 cycles)

- proof load test (2 x WLL)

AVAILABLE CERTIFICATES

- Technical Product Specifications
- Test Report UNI EN10204 type 2.2
- Inspection Certificate UNI EN10204 type 3.1
- CE Declaration of Conformity

	WLL	C	1	
			kg	mm
8052	800	18		1 080520008
8052	1120	22,5		1 080520011
8052	2000	30		1 080520020
8052	3150	36		1 080520031
8052	4000	39,5		1 080520040

	WLL	C	1	
			kg	mm
8055S	5400	32		1 080550145
8055S	8000	43		1 080550170
8055S	11500	53		1 080550215
8055S	16000	58		1 080550260
8055S	22000	78		1 080550320

8057R

self-locking lifting hooks,
eye type,
high-tensile alloy steel

CE

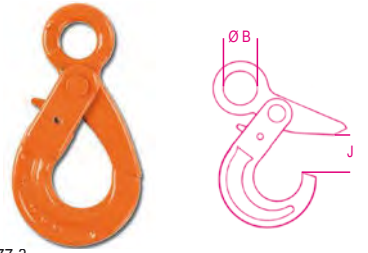

EN 1677-3

TECHNICAL DATA

- safety factor: 4
- heat treatment: hardening and tempering
- traceability code

LABORATORY TESTS

- chemical analysis, metallographic analysis
- tensile test

- fatigue test (min. 20,000 cycles)

- proof load test (100% of batch)

AVAILABLE CERTIFICATES

- Technical product specifications
- Test report UNI EN10204 type 2.2
- Inspection certificate UNI EN10204 type 3.1
- CE Declaration of Conformity

	WLL	J min	ØB	1	
				kg	mm
8057R	1120	6	28	22	1 080570112
8057R	2000	7-8	34	25	1 080570120
8057R	3150	10	44	32	1 080570132

8057	WLL	J min	ØB	1
kg	mm	mm	mm	
5300	13	54	40	1 080570053

8063

lifting swivel hooks
(in unloaded condition)
high-tensile alloy steel

CE



EN 1677-1

TECHNICAL DATA

- safety factor: 4
- heat treatment: hardening and tempering
- traceability code

LABORATORY TESTS

- chemical analysis, metallographic analysis
- tensile test
- fatigue test (min. 20,000 cycles)
- proof load test (100% of batch)

AVAILABLE CERTIFICATES

- Technical Product Specifications
- Test report UNI EN10204 type 2.2
- Inspection certificate UNI EN10204 type 3.1
- CE Declaration of Conformity

WLL kg	A mm	E mm	📄	📄
800	32	20,5	1	080630008
1120	38	20,5	1	080630011
2000	44,5	22	1	080630020
3150	44,5	27	1	080630031

8064S

swivel lifting hooks
(not under load)
carbon steel, painted

CE

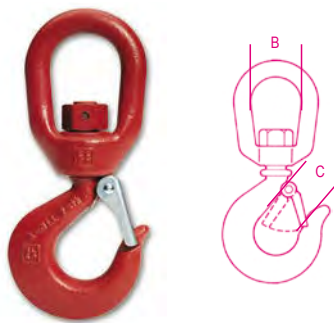

EN 1677-5

TECHNICAL DATA

- safety factor: 5
- heat treatment: hardening and tempering
- traceability code

LABORATORY TESTS

- chemical analysis, metallographic analysis
- proof load test (WLL x 2.5)
- tensile test
- fatigue test (min. 20,000 cycles)

AVAILABLE CERTIFICATES

- Technical product specifications
- Test report UNI EN10204 type 2.2
- Inspection certificate UNI EN10204 type 3.1
- CE Declaration of Conformity

WLL kg	B mm	C mm	📄	📄
800	31	20	1	080640107
1000	40	22	1	080640110
1600	47	23	1	080640115
2000	47	27	1	080640120
3200	64	35	1	080640130
5000	77	43	1	080640150
7500	90	53	1	080640175
10000	96	58	1	080640199

8065SC

swivel load lifting hooks
carbon steel, painted

CE

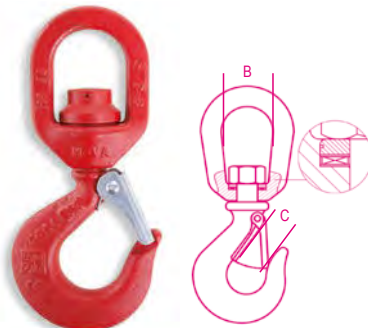

EN 1677-5

TECHNICAL DATA

- safety factor: 5
- heat treatment: hardening and tempering
- traceability code

LABORATORY TESTS

- chemical analysis, metallographic analysis
- proof load test (WLL x 2.5)
- tensile test
- fatigue test (min. 20,000 cycles)

AVAILABLE CERTIFICATES

- Technical product specifications
- Test report UNI EN10204 type 2.2
- Inspection certificate UNI EN10204 type 3.1
- CE Declaration of Conformity

WLL kg	B mm	C mm	📄	📄
800	38	20	1	080650107
1000	38	22	1	080650110
1600	47	23	1	080650115
2000	47	27	1	080650120
3200	54	35	1	080650130
5000	72	43	1	080650150
7500	82	53	1	080650175

8062

slip hooks
alloy steel, painted

CE

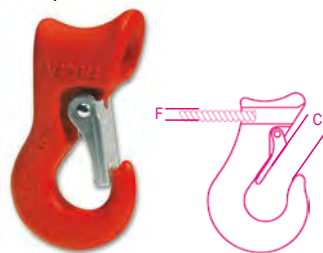

TECHNICAL DATA

- safety factor: 5
- heat treatment: hardening and tempering
- traceability code

LABORATORY TESTS

- chemical analysis, metallographic analysis
- proof load test (WLL x 2.5)
- tensile test

AVAILABLE CERTIFICATES

- Technical product specifications
- Test report UNI EN10204 type 2.2
- Inspection certificate UNI EN10204 type 3.1
- CE Declaration of Conformity

WLL kg	C mm	F mm	📄	📄
1500	19	10-13	1	080620013
2000	21	16	1	080620016
3000	26	18	1	080620018
5000	34	22-25	1	080620025

8051S

lifting eye hooks,
carbon steel, galvanized

CE

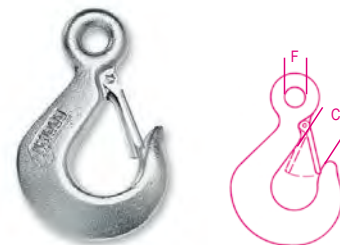

GRADO 4

TECHNICAL DATA

- safety factor: 4
- heat treatment: normalizing
- traceability code

LABORATORY TESTS

- chemical analysis
- metallographic analysis
- tensile test

AVAILABLE CERTIFICATES

- Technical product specifications
- Test report UNI EN10204 type 2.2
- Inspection certificate UNI EN10204 type 3.1
- CE Declaration of Conformity

WLL kg	C mm	F mm	📄	📄
250	14	12	10	080510202
500	18	16,5	5	080510205

special free service boxes



WLL kg	📄	📄	📄	📄
250	1	1	1	080519202
500	1	1	1	080519205

8100

lifting chains,
high-tensile alloy steel

CE

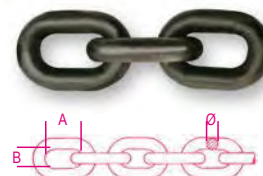

EN 818-2

TECHNICAL DATA

- safety factor: 4
- heat treatment: hardening and tempering
- traceability code

LABORATORY TESTS

- chemical analysis
- metallographic analysis
- tensile test

AVAILABLE CERTIFICATES

- Technical Product Specifications
- Test Report UNI EN10204 type 2.2
- Manufacturer's Certificate EN818-2
- CE Declaration of Conformity

WLL kg	📄	A mm	B min mm	📄	📄
1120	6	18	7,8	1	081000011
1500	7	21	11,0	1	081000016
2000	8	24	12,0	1	081000020
3150	10	30	14,5	1	081000032
5300	13	39	20,0	1	081000053
8000	16	48	20,8	1	081000080

Robur

8143

hand chain blocks

CE



EN13157

TECHNICAL DATA

safety factor: 4

identification tag

AVAILABLE CERTIFICATES

Manufacturer's Certificate

CE Declaration of Conformity

Test Report UNI EN10204 type 2.2

Technical Product Specifications

WLL H sforzo / effort

t	L m	mm	kg		
0,5	3	285	27	1	081430005
1	3	315	44	1	081430010
2	3	380	44	1	081430020
3	3	475	45	1	081430030
5	3	600	47	1	081430050

0,5	6	285	27	1	081430105
1	6	315	44	1	081430110
2	6	380	44	1	081430120
3	6	475	45	1	081430130
5	6	600	47	1	081430150

8146

lever hoists

CE



EN13157

TECHNICAL DATA

safety factor: 4

identification tag

AVAILABLE CERTIFICATES

Manufacturer's Certificate

CE Declaration of Conformity

Test Report UNI EN10204 type 2.2

Technical Product Specifications

WLL H sforzo / effort

t	L m	mm	kg		
0,75	1,5	320	21	1	081460008
1,5	1,5	380	41	1	081460015
3,0	1,5	480	41	1	081460030
6,0	1,5	600	46	1	081460060

0,75	3,0	320	21	1	081460108
1,5	3,0	380	41	1	081460115
3,0	3,0	480	41	1	081460130
6,0	3,0	600	46	1	081460160

Robur

Robur

8146C

lever hoist, compact

CE



EN13157

TECHNICAL DATA

safety factor: 4

identification tag

AVAILABLE CERTIFICATES

Manufacturer's Certificate

CE Declaration of Conformity

Test Report UNI EN10204 type 2.2

Technical Product Specifications

WLL H sforzo / effort

t	L m	mm	kg		
0,25	1,5	230	20,7	1	081460002

8120

Genovese chains
for static connections,
galvanised



TECHNICAL DATA

- safety factor: 4
- AVAILABLE CERTIFICATES
- Technical product specifications
- Test report UNI EN10204 type 2.2

Ø mm	nr	WFL		
		kg	m	
1,5	10	8	150	1 081200015
1,6	12	15	150	1 081200016
2,2	14	25	75	1 081200022
2,7	16	40	75	1 081200027
3,0	17	55	75	1 081200030
3,4	18	100	60	1 081200034
3,8	19	110	50	1 081200038
4,4	20	200	40	1 081200044
4,8	21	250	30	1 081200048
5,5	22	300	25	1 081200055
5,8	23	310	25	1 081200058
6,5	24	400	25	1 081200065
7,5	26	550	20	1 081200075
* 8,0	27	600	25	1 081200080
* 9,0	28	800	25	1 081200090
* 10,0	30	1000	20	1 081200100
* 12,0	32	1400	15	1 081200120

Caution: product NOT designed for lifting purposes

(*) available in COILS

8120B

Genovese chains
for static connections,
galvanised



TECHNICAL DATA

- safety factor: 4
- AVAILABLE CERTIFICATES
- Technical product specifications
- Test report type 2.2 UNI EN10204

Ø mm	nr	WFL		
		kg	m	
1,5	10	8	200	1 081200315
1,6	12	15	200	1 081200316
2,2	14	25	100	1 081200322
2,7	16	40	100	1 081200327
3,0	17	55	75	1 081200330
3,4	18	100	100	1 081200334
3,8	19	110	75	1 081200338
4,4	20	200	50	1 081200344
4,8	21	250	50	1 081200348
5,5	22	300	40	1 081200355
5,8	23	310	30	1 081200358
6,5	24	400	30	1 081200365
7,5	26	550	25	1 081200375
8,0	27	600	15	1 081200380
9,0	28	800	15	1 081200390
10,0	30	1000	10	1 081200400
12,0	32	1400	8	1 081200420

Caution: NOT for lifting

8129

barrier chain,
made of galvanized metal painted in red and
white



Ø mm	m		
5	30	1	081290050

Caution: NOT for lifting or anchoring

8074

carabine hooks,
galvanized

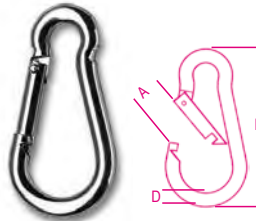

DIN 5299

TECHNICAL DATA

- safety factor: 4
- AVAILABLE CERTIFICATES
- Technical product specifications
- Test report UNI EN10204 type 2.2

DxL	A	WFL		
mm	mm	kg		
* 4x40	6	20	100	080740040
5x50	7	30	100	080740050
6x60	8	40	100	080740060
7x70	9	60	50	080740070
8x80	11	75	50	080740080
9x90	12	100	25	080740090
10x100	13	120	25	080740100
11x120	16	140	20	080740101
12x140	22	140	15	080740102
13x160	24	200	10	080740103
* 14x180	32	250	5	080740104

8074A

ring carabine hooks,
galvanized



DIN 5299

TECHNICAL DATA

- safety factor: 4
- AVAILABLE CERTIFICATES
- Technical product specifications
- Test report UNI EN10204 type 2.2

øAxL	D	WFL		
mm	mm	kg		
5x50	7,4	30	50	080740405
6x60	8,7	40	50	080740406
8x80	10,5	75	25	080740408
10x100	13,3	120	10	080740410

8074G

carabine hooks with screw nut,
galvanized

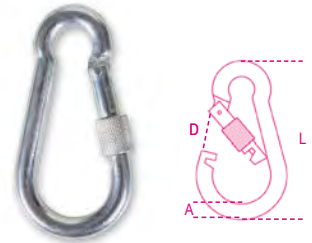

TECHNICAL DATA

- safety factor: 4
- AVAILABLE CERTIFICATES
- Technical product specifications
- Test report UNI EN10204 type 2.2

øAxL	D	WFL		
mm	mm	kg		
5x50	7,5	30	50	080740305
6x60	8,5	40	50	080740306
8x80	10,3	75	25	080740308
10x100	10,6	120	10	080740310

8080

quick links,
galvanized

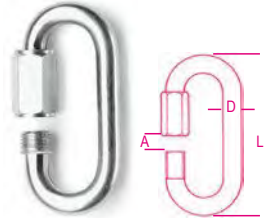

TECHNICAL DATA

- safety factor: 4
- AVAILABLE CERTIFICATES
- Technical product specifications
- Test report UNI EN10204 type 2.2

DxL	A	WFL		
mm	mm	kg		
3,5x36	5	20	100	080800003
4x40	6	30	100	080800004
5x49	6	50	100	080800005
6x57	8	60	100	080800006
7x66	8	100	50	080800007
8x74	11	140	50	080800008
9x80	11	160	25	080800009
10x89	11	220	25	080800010
12x105	15	300	20	080800012
14x125	16,5	400	3	080800014

8082

rings
galvanised steel

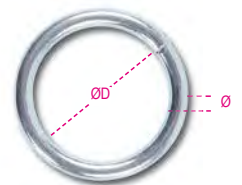

Ø	ØD		
mm	mm		
4	20	50	080820004
5	30	20	080820005
6	40	10	080820006
7	50	5	080820007
8	60	5	080820008

8083

S-hooks
galvanised steel

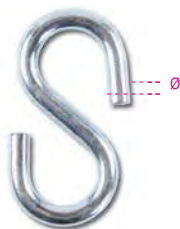

Ø mm	L mm		
3	33	40	080830003
4	40	30	080830004
5	47	20	080830005
6	59	15	080830006
8	79	5	080830008

8114

eye and eye swivels,
italian "Marche" type,
carbon steel, galvanized

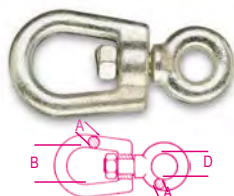

TECHNICAL DATA

- safety factor: 4
- traceability code

LABORATORY TESTS

- tensile test

AVAILABLE CERTIFICATES

- Technical product specifications
- Test report UNI EN10204 type 2.2

A mm	B mm	D mm	WFL kg		
8	30	16	250	1	081140008
10	38	18	300	1	081140010
12	42	20	650	1	081140012
14	48	22	820	1	081140014
16	57	24	1000	1	081140016
18	64	26	1600	1	081140018
20	72	30	2000	1	081140020
22	80	34	2500	1	081140022

8116

eye and eye swivels,
carbon steel, galvanized

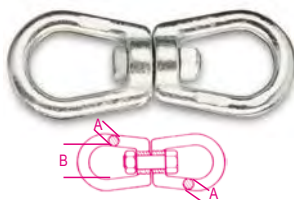

TECHNICAL DATA

- safety factor: 4
- traceability code

LABORATORY TESTS

- tensile test

AVAILABLE CERTIFICATES

- Technical product specifications
- Test report UNI EN10204 type 2.2

A mm	B mm	WFL kg		
6	23	140	1	081160006
8	30	250	1	081160008
10	38	300	1	081160010
12	42	650	1	081160012
14	48	820	1	081160014
16	57	1000	1	081160016
18	64	1600	1	081160018
20	72	2000	1	081160020
22	80	2500	1	081160022

8317SZ

simplex wire rope clips
galvanized



AVAILABLE CERTIFICATES

- Test report UNI EN10204 type 2.2

Ø mm	L mm	L1 mm		
2	15	14	100	083170102
3	18	16	100	083170103
4	20	19	100	083170104
5	24	23	50	083170105
6	30	27	30	083170106
8	36	34	20	083170108
10	42	37	10	083170110

8317DZ

duplex wire rope clips
galvanized



AVAILABLE CERTIFICATES

- Test report UNI EN10204 type 2.2

Ø mm	L mm	L1 mm		
2	30	14	50	083170002
3	35	15	50	083170003
4	40	18	50	083170004
5	50	21	25	083170005
6	60	25	20	083170006
8	76	33	10	083170008
10	95	37	10	083170010

8381SL

U bolts for pipes, light type,
galvanized

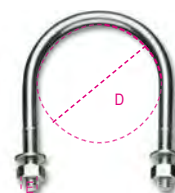

AVAILABLE CERTIFICATES

- Technical product specifications
- Test report UNI EN10204 type 2.2

D mm	D gas	E mm		
11	1/8"	M6	100	083810201
14	1/4"	M6	100	083810202
18	3/8"	M6	100	083810203
22	1/2"	M6	100	083810204
27	3/4"	M6	100	083810205
34	1"	M6	100	083810206
43	1 1/4"	M6	100	083810207
49	1 1/2"	M8	50	083810208
61	2"	M8	50	083810209
77	2 1/2"	M8	25	083810210
89	3"	M8	25	083810211
102	3 1/2"	M8	25	083810212
115	4"	M8	25	083810213
168	6"	M10	25	083810218
220	8"	M10	10	083810220

8381SP

U bolts for pipes, heavy type,
galvanized



AVAILABLE CERTIFICATES

- Technical product specifications
- Test report UNI EN10204 type 2.2

D mm	D gas	E mm		
22	1/2"	M8	100	083810301
27	3/4"	M8	100	083810302
34	1"	M8	100	083810303
43	1 1/4"	M8	100	083810304
49	1 1/2"	M10	25	083810305
61	2"	M10	25	083810306
77	2 1/2"	M10	25	083810307
89	3"	M10	25	083810308
102	3 1/2"	M12	25	083810309
115	4"	M12	15	083810310
168	6"	M16	15	083810315
220	8"	M16	10	083810320
274	10"	M16	1	083810374
274	10"	M20	1	083810375
324	12"	M20	1	083810386
408	16"	M24	1	083810508

 **Robur**

 **Robur**

8383C
square U bolts,
hot galvanized
Flanged nuts

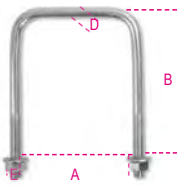

AVAILABLE CERTIFICATES
• Technical Product Specifications
• Test Report UNI EN10204 type 2.2

A	E	B	D		
mm	mm	mm	mm		
70	M10	110	8,55	130	083830070
80	M10	120	8,55	110	083830080
90	M10	130	8,55	100	083830090
100	M10	155	8,55	90	083830100
120	M10	175	8,55	70	083830120

8383P
plates for square U bolts
hot galvanized

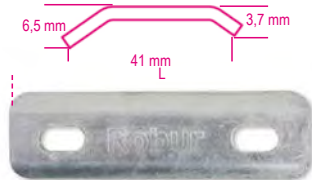

AVAILABLE CERTIFICATES
• Technical product specifications
• Test report UNI EN10204 type 2.2

	L		
	mm		
8383P 150	150	150	083830214
8383C/70-80 /90-100			
8383P 170	170	120	083830217
8383C/100-120			

8515Z
wire tenders, galvanized



Available Certificates
• Test Report UNI EN10204 type 2.2

D	H	L		
mm	mm	mm		
20	25	93	50	085150002
24,5	30	100	50	085150003

8515V
wire tenders,
galvanized and painted



Available Certificates
• Test Report UNI EN10204 type 2.2

D	H	L		
mm	mm	mm		
20	25	93	50	085150102
24,5	30	100	50	085150103

8515CH
wire tender keys,
galvanized



L	OA	OB		
mm	mm	mm		
90	8	7,5	20	085150901

8531
dee FISHING shackles,
hot-dip galvanized

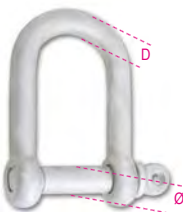

AVAILABLE CERTIFICATES
• Test report UNI EN10204 type 2.2

Ø	D	WFL		
mm	mm	kg		
20	18	1600	1	085310018
22	20	2500	1	085310020

8532
dee FISHING shackles
with square head screw pin,
black painted



AVAILABLE CERTIFICATES
• Test report UNI EN10204 type 2.2

Ø	D	WFL		
mm	mm	kg		
20	20	1600	1	085320020
22	22	2500	1	085320022

8535
fishing hooks,
galvanized

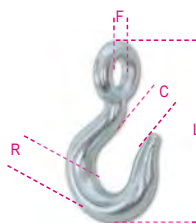

AVAILABLE CERTIFICATES
• Test report UNI EN10204 type 2.2

R	C	F	L		
mm	mm	mm	mm		
26	27,5	34	156	1	085350006
30	36,5	40	185	1	085350007

8130
antitheft chains, made of alloy steel,
case-hardened, tempered,
galvanised



Ø mm	L		
mm	mm		
6	800	1	081300068
8	1000	1	081300081
8	1200	1	081300082
10	1500	1	081300105

8130A
anti-theft chains with rings,
made of alloy steel, case-hardened, tempered,
galvanised



Ø mm	L		
mm	mm		
10	900	1	081300209

8131Z
antitheft chains with padlocks



Ø mm	L	8139Z		
mm	mm	Ø mm		
6	800	8	1	081310060
6	800	10	1	081310068
8	1000	10	1	081310081
8	1200	10	1	081310082
10	1500	10	1	081310105

8131DL
disc lock with anti-theft chain 8130A



Ø mm	L		
mm	mm		
10	900	1	081310209

8139DL

motorcycle disc locks,
made of hardened steel, shockproof PVC,
blister-packed

- supplied with 3 keys, signalling cable, case
- suitable for 10mm chains



Ø mm	L mm	H mm		
14	108	56	1	081390214

8139Z

padlocks for antitheft chains,
zinc alloy bodies

- supplied with 3 mapped keys
- suitable for chains 6, 8, 10 mm



Ø mm	L mm	H mm		
8	45	90	1	081390008
10	55	98	1	081390009

8139ZCH

3 neutral spare keys
for locks 8139Z



8139ZCH	1	081390909

suitable for locks Ø8 and Ø10

8050 D1÷D45

safety locks and spare parts kit for eye hooks



8050D1	1	080500945
8064S-8065SC/800		
8050D2	1	080500946
8064S-8065SC/1000		
8050D3	1	080500947
8064S-8065SC/1600-2000		
8050D4	1	080500948
8055S/5400 - 8064S-8065SC/3200		
8050D5	1	080500949
8055S/8000		
8064S-8065SC/5000		
8050D6	1	080500950
8055S/11500		
8064S/7500		
8050D10	1	080500954
8062/1500		

8050D11	1	080500955
8062/2000		
8050D12	1	080500956
8062/3000		
8050D13	1	080500957
8062/5000		
8050D22	1	080500966
8055S/16000		
8064S/10000		
8050D23	1	080500967
8055S/22000		
8050D24	1	080500969
8051S/250		
8050D25	1	080500970
8051S/500		
8050D29	1	080500974
8061F/5300		
8050D30	1	080500975
8061F/8000		
8050D32	1	080500977
8060/8000		
8050D33	1	080500978
8052/800		
8050D34	1	080500979
8052/1120		
8050D35	1	080500980
8052/2000		
8050D36	1	080500981
8052/3150		
8050D37	1	080500982
8052/4000		
8050D38	1	080500983
8060R/1120		
8050D53	1	080500994
8060R/1500		
8050D39	1	080500984
8060R/2000		
8050D40	1	080500985
8060R/3150		
8050D41	1	080500986
8060R/5300		
8050D42	1	080500987
8063/800		
8050D43	1	080500988
8063/1120		
8050D44	1	080500989
8063/2000		
8050D45	1	080500990
8063/3150		



8050D46	1	080500991
8061R/1120		
8050D47	1	080500992
8061R/2000		
8050D48	1	080500993
8061R/3150		
8050D54	1	080500995
8061R/5300		



8050 D49	1	080500849
8057R/1120 - 8058R/1120		
8050 D50	1	080500850
8057R/2000 - 8058R/2000		
8050 D51	1	080500851
8057R/3150 - 8058R/3150		
8050 D52	1	080500852
8057R/5300 - 8058R/5300		

8058R/PS

pin kit for hooks item 8058R-8061R



	Ø mm		
8058R/PS	6	1	080580512
8058R/PS	7-8	1	080580520
8058R/PS	10	1	080580532
8058R/PS	13	1	080580553

8060R/PS

pin kit for hooks item 8060R



	Ø mm		
8060R/PS	6	1	080600511
8060R/PS	7	1	080600515
8060R/PS	8	1	080600520
8060R/PS	10	1	080600532
8060R/PS	13	1	080600553

8143/RK

safety locks, pins and stops
for hand CHAIN blocks 8143



8143/RK 0,5t	1	081430905
8143/RK 1,0t	1	081430915
8143/RK 2,0t	1	081430920
8143/RK 3,0t	1	081430930
8143/RK 5,0t	1	081430950

8146/RK

safety locks, pins and stops
for hand LEVER hoists 8146C-8146



8146/RK 0,25t	1	081460902
8146/RK 0,75t	1	081460908
8146/RK 1,50t	1	081460915
8146/RK 3,00t	1	081460930
8146/RK 6,00t	1	081460960

Robur

Breaking force (BF)
on technical specifications
WWW.ROBURITALY.COM

8205

eye and eye turnbuckle
AISI 316

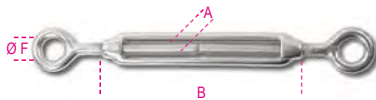

LABORATORY TESTS

- chemical analysis
- tensile test

AVAILABLE CERTIFICATES

- Technical product specifications
- Test report UNI EN10204 type 2.2

A	B	ø F	WFL		
mm	mm	mm	kg		
M4	62	8	75	10	082050204
M5	72	11	115	10	082050205
M6	92	12	160	5	082050206
M8	122	14	300	5	082050208
M10	150	16	470	1	082050210
M12	201	18	690	1	082050212
M14	225	22	940	1	082050214
M16	244	26	1290	1	082050216
M20	295	29	2130	1	082050220
M24	350	33	3000	1	082050224

8206

hook and eye turnbuckle
AISI 316

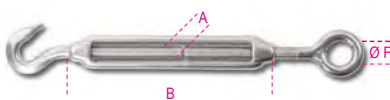

LABORATORY TESTS

- chemical analysis
- tensile test

AVAILABLE CERTIFICATES

- Technical product specifications
- Test report UNI EN10204 type 2.2

A	B	ø F	WFL		
mm	mm	mm	kg		
M5	72	11	25	10	082060205
M6	92	12	45	5	082060206
M8	122	14	95	5	082060208
M10	150	16	140	1	082060210
M12	201	18	300	1	082060212
M14	225	22	420	1	082060214
M16	244	26	570	1	082060216
M20	295	29	875	1	082060220

8207

hook and hook turnbuckle
AISI 316

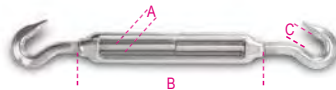

LABORATORY TESTS

- chemical analysis
- tensile test

AVAILABLE CERTIFICATES

- Technical product specifications
- Test report UNI EN10204 type 2.2

A	B	C	WFL		
mm	mm	mm	kg		
M5	72	9	25	10	082070205
M6	92	9	45	5	082070206
M8	122	10	95	5	082070208
M10	150	12	140	1	082070210
M12	201	14	300	1	082070212
M14	225	15	420	1	082070214
M16	244	16	570	1	082070216
M20	295	19	875	1	082070220

8209

jaw and jaw turnbuckle
AISI 316

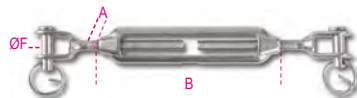

LABORATORY TESTS

- chemical analysis
- tensile test

AVAILABLE CERTIFICATES

- Technical product specifications
- Test report UNI EN10204 type 2.2

A	B	ø F	WFL		
mm	mm	mm	kg		
M5	72	5	115	5	082090205
M6	92	6	160	5	082090206
M8	122	8	300	5	082090208
M10	150	10	470	1	082090210
M12	201	12	690	1	082090212
M14	225	14	940	1	082090214
M16	244	16	1290	1	082090216
M20	295	20	2130	1	082090220
M24	350	24	3060	1	082090224

8210

jaw and jaw pipe turnbuckle
AISI 316

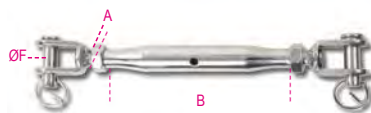

LABORATORY TESTS

- chemical analysis
- tensile test

AVAILABLE CERTIFICATES

- Technical product specifications
- Test report UNI EN10204 type 2.2

A	B	ø F	WFL		
mm	mm	mm	kg		
M5	81	5	115	3	082100205
M6	92	6	160	3	082100206
M8	112	8	300	1	082100208
M10	121	10	470	1	082100210
M12	150	12	690	1	082100212
M14	169	14	940	1	082100214
M16	190	16	1290	1	082100216
M20	220	20	2130	1	082100220

8201T

pipe bodies
AISI 316



LABORATORY TESTS

- chemical analysis
- tensile test

AVAILABLE CERTIFICATES

- Technical Product Specifications
- Test Report UNI EN10204 type 2.2

ø	ø	WFL	L		
mm	"	kg	mm		
M6	1/4	160	95	5	082010406
M8	5/16	300	105	5	082010408
M10	3/8	470	125	3	082010410
M12	1/2	690	150	3	082010412
M14	9/16	940	165	1	082010414
M16	5/8	1290	190	1	082010416
M20	3/4	2130	210	1	082010420

8248

eye tie rods,
stainless steel 316L,
right thread



UNI 6058

AVAILABLE CERTIFICATES

- Technical Product Specifications
- Test Report UNI EN10204 type 2.2

øxL	F		
mm	mm		
10x80	8	1	082480010
10x130	8	1	082480012
12x95	10	1	082480016
12x125	10	1	082480018

8249

fastening eyebolts, right thread
AISI 316



LABORATORY TESTS

- chemical analysis
- tensile test

AVAILABLE CERTIFICATES

- Technical product specifications
- Test report UNI EN10204 type 2.2

A	ø B	D	WFL		
mm	mm	mm	kg		
M5	11	50	100	10	082490205
M6	13	55	160	10	082490206
M8	17	60	300	5	082490208
M10	21	80	470	5	082490210
M12	25	120	690	1	082490212

8249G

fastening hooks
AISI 316



LABORATORY TESTS

- chemical analysis
- tensile test

AVAILABLE CERTIFICATES

- Technical Product Specifications
- Test Report UNI EN10204 type 2.2

A	E	ØF	WFL		
mm	mm	mm	kg		
M5	39	9	25	5	082490305
M6	43	10,5	45	5	082490306
M8	57	14,5	95	3	082490308

8216

wire rope clips
AISI 316

CE

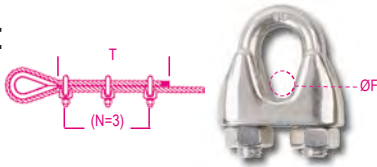

LABORATORY TESTS

- chemical analysis
- torque test

AVAILABLE CERTIFICATES

- Technical product specifications
- Test report UNI EN10204 type 2.2
- CE Certificate of Conformity

ØF	"	T	N		
mm		mm			
2	5/64	80	3	15	082160202
3	1/8	80	3	15	082160203
4	5/32	80	3	10	082160204
5	3/16	110	3	10	082160205
6	1/4	120	5	10	082160206
8	5/16	210	5	5	082160208
10	3/8	240	5	5	082160210
12-13	1/2	300	5	5	082160213
16	5/8	335	5	5	082160216
20	3/4	540	5	5	082160220
22	7/8	595	7	3	082160222

special free service boxes



ØF			
mm			
2	4	1	082169402
3	4	1	082169403
4	4	1	082169404
5	2	1	082169405
6	2	1	082169406
8	2	1	082169408
10	2	1	082169410

Robur

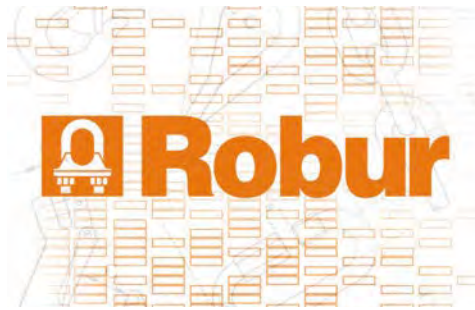

8220

thimbles
AISI 316

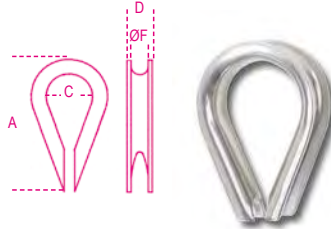

LABORATORY TESTS

- chemical analysis

AVAILABLE CERTIFICATES

- Technical product specifications
- Test report UNI EN10204 type 2.2

ØF	D	A	C		
mm	mm	mm	mm		
2	4,5	21	7,5	15	082200202
3	6	24	10	15	082200203
4	6,6	28	11	10	082200204
5	8,5	30	13	10	082200205
6	10	37	15	10	082200206
8	12,5	51	23	5	082200208
10	14,6	56	27	5	082200210
12	18	68	32	5	082200212
14	19	69	34	5	082200214
16	22	83	37	5	082200216
18	23	81	38	1	082200218
20	27,8	105	45	1	082200220
22	29,6	112	45	1	082200222

8225

dee shackles
AISI 316



LABORATORY TESTS

- chemical analysis
- tensile test

AVAILABLE CERTIFICATES

- Technical product specifications
- Test report UNI EN10204 type 2.2

ØD	"	A	WFL		
mm		mm	kg		
4	5/32	8	50	10	082250204
5	3/16	11	70	10	082250205
6	1/4	13	100	5	082250206
8	5/16	17	250	5	082250208
10	3/8	21	400	3	082250210
12	1/2	25	600	3	082250212
16	5/8	32	1000	1	082250216
19	3/4	38	1600	1	082250219
22	7/8	43	2000	1	082250222
25	1	46	2800	1	082250225

8227

long dee shackles
AISI 316



LABORATORY TESTS

- chemical analysis
- tensile test

AVAILABLE CERTIFICATES

- Technical product specifications
- Test report UNI EN10204 type 2.2

ØD	"	A	WFL		
mm		mm	kg		
4	5/32	8	50	10	082270204
5	3/16	10	70	10	082270205
6	1/4	13,5	100	5	082270206
8	5/16	17	250	5	082270208
10	3/8	21	400	1	082270210
12	1/2	25	600	1	082270212

8228

bow shackles
AISI 316

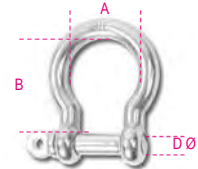

LABORATORY TESTS

- chemical analysis
- tensile test

AVAILABLE CERTIFICATES

- Technical product specifications
- Test report UNI EN10204 type 2.2

ØD	A	B	WFL		
mm	mm	mm	kg		
4	13	20	60	10	082280204
5	17	23	80	10	082280205
6	20	27	100	10	082280206
8	28	36	200	5	082280208
10	36	44	300	5	082280210
12	41	53	500	5	082280212
16	54	74	800	1	082280216
19	66	86	1100	1	082280219

Robur

8240F

lifting eye bolts, FORGED
stainless steel A4

CE



TECHNICAL DATA

- safety factor: 6
- traceability code

LABORATORY TESTS

- chemical analysis
- metallographic analysis
- tensile test

AVAILABLE CERTIFICATES

- Technical product specifications
- Test report UNI EN10204

type 2.2

- Inspection certificate UNI EN10204

type 3.1

- CE Declaration of Conformity

ø mm	WLL mm	WLL kg		
M6	1,0	120	4	082400406
* M8	1,25	200	4	082400408
* M10	1,5	400	4	082400410
* M12	1,75	600	4	082400412
* M14	2	1000	2	082400414
* M16	2	1200	2	082400416
* M20	2,5	2000	2	082400420
* M24	3	2700	2	082400424
* M30	3,5	4000	1	082400430

(*) WLL increased compared to DIN standard according to Technical Specifications R/FT/8240F (guaranteed for stainless steel / stainless steel fits)

8240

eye bolts,
stainless steel AISI 316



LABORATORY TESTS

- chemical analysis
- tensile test

AVAILABLE CERTIFICATES

- Technical product specifications
- Test report UNI EN10204 type 2.2

A mm	B mm	ø C mm	WFL kg		
M6	41	15	90	10	082400206
M8	50	20	140	10	082400208
M10	62	25	230	5	082400210
M12	74	30	340	5	082400212

8242F

lifting eye nuts, FORGED
stainless steel A4

CE



TECHNICAL DATA

- safety factor: 6
- traceability code

LABORATORY TESTS

- chemical analysis
- metallographic analysis
- tensile test

AVAILABLE CERTIFICATES

- Technical product specifications
- Test report UNI EN10204

type 2.2

- Inspection certificate UNI EN10204

type 3.1

- CE Declaration of conformity

ø mm	WLL mm	WLL kg		
M6	1,0	120	4	082420406
* M8	1,25	200	4	082420408
* M10	1,5	400	4	082420410
* M12	1,75	600	4	082420412
* M14	2	1000	2	082420414
* M16	2	1200	2	082420416
* M20	2,5	2000	2	082420420
* M24	3	2700	2	082420424
* M30	3,5	4000	1	082420430

(*) WLL ø M10÷M24

- increased according to Technical File R/FT/8242F

- guaranteed with stainless steel coupling

8242

eye nuts
stainless steel AISI 316



A mm	B mm	ø C mm	WFL kg		
M6	27	15	90	10	082420206
M8	36	20	140	10	082420208
M10	45	25	230	5	082420210
M12	55	30	340	5	082420212



8274

carabine hooks
AISI 316

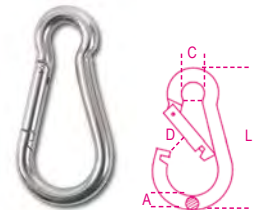

LABORATORY TESTS

- chemical analysis
- tensile test

AVAILABLE CERTIFICATES

- Technical product specifications
- Test report UNI EN10204 type 2.2

ø A x L mm	ø C mm	D mm	WFL kg		
4,5x40	6,5	6	20	10	082740204
5x50	7	6,5	30	10	082740205
6x60	8,5	7,5	40	5	082740206
7x70	10	9	60	5	082740207
8x80	12	10	75	5	082740208
9x90	12,5	10,5	100	5	082740209
10x100	15	13	120	1	082740210
11x120	19	18	140	1	082740211
12x140	22	21	140	1	082740212
13x160	22	26	200	1	082740213

8274A

ring carabine hooks
AISI 316

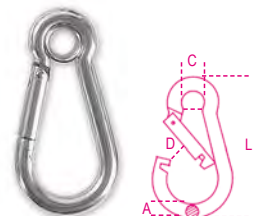

LABORATORY TESTS

- chemical analysis
- tensile test

AVAILABLE CERTIFICATES

- Technical Product Specifications
- Test Report UNI EN10204 type 2.2

ø A x L mm	ø C mm	D mm	WFL kg		
5x50	6,5	7	30	10	082740405
6x60	7,5	7,5	40	5	082740406
8x80	9,5	10	75	5	082740408

8274G

carabine hooks with screw nut
AISI 316

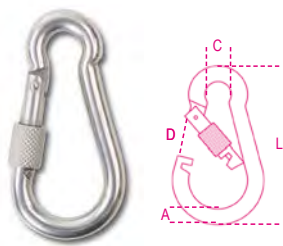

LABORATORY TESTS

- chemical analysis
- tensile test

AVAILABLE CERTIFICATES

- Technical product specifications
- Test report UNI EN10204 type 2.2

ø A x L	ø C	D	WFL		
mm	mm	mm	kg		
6x60	8,5	6,5	40	5	082740306
8x80	12	8,5	75	5	082740308
10x100	15	12	120	3	082740310

8276

asymmetric carabine hooks
AISI 316

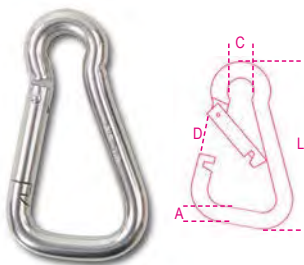

LABORATORY TESTS

- chemical analysis
- tensile test

AVAILABLE CERTIFICATES

- Technical product specifications
- Test report UNI EN10204 type 2.2

ø A x L	ø C	D	WFL		
mm	mm	mm	kg		
6x60	8,5	10	40	5	082760206
8x80	12	14	75	5	082760208
10x100	15	18	120	3	082760210



8276G

asymmetric carabine hooks with screw nut
AISI 316

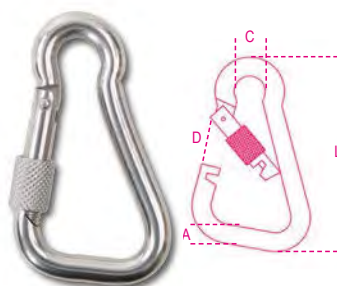

LABORATORY TESTS

- chemical analysis
- tensile test

AVAILABLE CERTIFICATES

- Technical product specifications
- Test report UNI EN10204 type 2.2

ø A x L	ø C	D	WFL		
mm	mm	mm	kg		
6x60	8,5	9	40	3	082760306
8x80	12	12,5	75	3	082760308
10x100	15	16	120	3	082760310

8278

trapezoidal carabine hooks
AISI 316

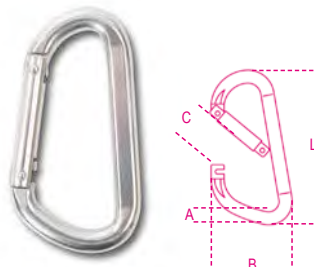

LABORATORY TESTS

- chemical analysis
- tensile test

AVAILABLE CERTIFICATES

- Technical product specifications
- Test report UNI EN10204 type 2.2

ø A x L	B	C	WFL		
mm	mm	mm	kg		
8x80	45	14	75	3	082780208
10x100	55	16	120	3	082780210

8280

quick links
AISI 316

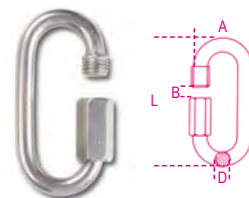

LABORATORY TESTS

- chemical analysis
- tensile test

AVAILABLE CERTIFICATES

- Technical product specifications
- Test report UNI EN10204 type 2.2

ø D x L	A	B	WFL		
mm	mm	mm	kg		
3,5x35	17	5	20	10	082800203
4x40	19	6	30	10	082800204
5x50	23	7	50	5	082800205
6x60	26	8	60	5	082800206
7x70	30	9	100	5	082800207
8x80	33	10	140	1	082800208
10x90	40	12	220	1	082800210
12x100	47	14	300	1	082800212

8250

spring snap-casting eye end
AISI 316



LABORATORY TESTS

- chemical analysis
- tensile test

AVAILABLE CERTIFICATES

- Technical product specifications
- Test report UNI EN10204 type 2.2

L	A	ø B	WFL		
mm	mm	mm	kg		
50	25	8	40	5	082500205
70	31	12,5	90	5	082500207
100	47	20	190	1	082500210

8264

swivel eye bolt snap
AISI 316



LABORATORY TESTS

- chemical analysis
- tensile test

AVAILABLE CERTIFICATES

- Technical product specifications
- Test report UNI EN10204 type 2.2

B	L	C	WFL		
mm	mm	mm	kg		
12	88	12	60	5	082640212
16	90	12	60	5	082640216
19	93	12	60	1	082640219

8267

swivel eye snap
AISI 316



LABORATORY TESTS

- chemical analysis
 - tensile test
- AVAILABLE CERTIFICATES
- Technical product specifications
 - Test report UNI EN10204 type 2.2

A	L	B	WFL		
mm	mm	mm	kg		
10	87	21	30	5	082670210
12	118	22	70	1	082670213

8272

eye and eye swivels
AISI 316

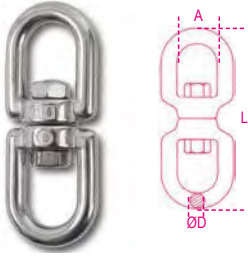

LABORATORY TESTS

- chemical analysis
 - tensile test
- AVAILABLE CERTIFICATES
- Technical product specifications
 - Test report UNI EN10204 type 2.2

ø D	A	L	WFL		
mm	mm	mm	kg		
4	11	50	90	5	082720204
5	13	60	115	5	082720205
6	15	66	140	5	082720206
8	19	90	250	3	082720208
10	23	112	300	1	082720210
13	33	148	650	1	082720213
16	38	184	1000	1	082720216
19	40	223	1600	1	082720219

8273

quick-release hooks
with swivel eyes
AISI 316 stainless steel



LABORATORY TESTS

- chemical analysis
 - tensile test
- AVAILABLE CERTIFICATES
- Technical product specifications
 - Test report UNI EN10204 type 2.2

ø C x L	B	WFL	BF		
mm	mm	kg	kg		
12x70	12	230	1100	1	082730012
16x85	14,50	440	2000	1	082730016
22x120	20	700	3500	1	082730022

8282

S-hooks
AISI 316



LABORATORY TESTS

- chemical analysis
 - tensile test
- AVAILABLE CERTIFICATES
- Technical product specifications
 - Test report UNI EN10204 type 2.2

ø D	B1	B2	WFL		
mm	mm	mm	kg		
3	7,5	14	4	10	082820203
4	10,5	14,5	5	10	082820204
5	12,5	16	12	10	082820205
6	12,5	18	18	5	082820206
8	14	23	33	5	082820208

8282S

S-hooks, symmetric
AISI 316 stainless steel

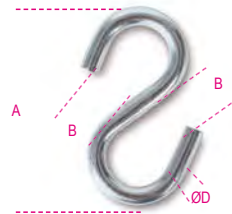

LABORATORY TESTS

- chemical analysis
 - tensile test
- AVAILABLE CERTIFICATES
- Product specifications
 - Test report type 2.2 UNI EN10204

ø D	B	A	WFL		
mm	mm	mm	kg		
3	5,5	34	4	40	082820303
4	7,0	40	5	30	082820304
5	9,0	46	12	20	082820305
6	10	54	18	15	082820306

8284

pelican hooks terminals
AISI 316 stainless steel



LABORATORY TESTS

- chemical analysis
 - tensile test
- AVAILABLE CERTIFICATES
- Technical product specifications
 - Test report UNI EN10204 type 2.2

ø C	B	L	WFL		
mm	mm	mm	kg		
6	11	73	200	3	082840006
8	14	98	300	3	082840008
10	23	143	450	1	082840010

8285

jaw terminals
AISI 316

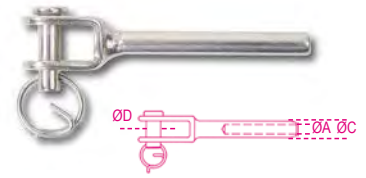

LABORATORY TESTS

- chemical analysis
 - tensile test
- AVAILABLE CERTIFICATES
- Technical product specifications
 - Test report UNI EN10204 type 2.2

ø A	ø C	ø D	WFL		
mm	mm	mm	kg		
3	6,3	6	180	5	082850203
4	7,5	6	200	3	082850204
5	9	10	330	1	082850205
6	12,5	12	720	1	082850206
8	16	13	1120	1	082850208

8286

eye terminals
AISI 316



LABORATORY TESTS

- chemical analysis
 - tensile test
- AVAILABLE CERTIFICATES
- Technical product specifications
 - Test report UNI EN10204 type 2.2

ø D	ø A	ø C	WFL		
mm	mm	mm	kg		
3	6,5	6,3	180	5	082860203
4	8,5	7,5	200	3	082860204
5	10,6	9	330	1	082860205
6	13	12,5	720	1	082860206
8	14,7	16	1120	1	082860208

8287

swage studs
AISI 316

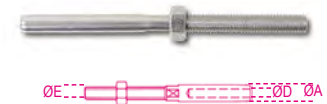

LABORATORY TESTS

- chemical analysis
 - tensile test
- AVAILABLE CERTIFICATES
- Technical product specifications
 - Test report UNI EN10204 type 2.2

ø D	ø A	E	WFL		
mm	mm	mm	kg		
3	6,3	M6	180	5	082870203
4	7,5	M8	200	3	082870204
5	9	M10	330	1	082870205
6	12,5	M12	720	1	082870206
8	16	M16	1120	1	082870208

8290

pad eyes
AISI 316



LABORATORY TESTS

- chemical analysis
- AVAILABLE CERTIFICATES
- Technical product specifications
- Test report UNI EN10204 type 2.2

Ø A	B	Ø C	L		
mm	mm	mm	mm		
5	18	4,3	40	5	082900205
6	22	5,2	44	5	082900206
8	23	5,2	51	5	082900208

8381SX

U bolts for pipes

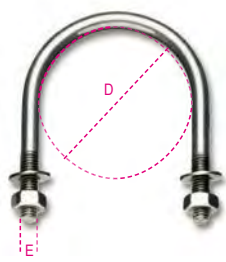

AISI 304

LABORATORY TESTS

- chemical analysis
- AVAILABLE CERTIFICATES
- Test report UNIEN10204 type 2.2

D	D	E		
mm	gas	mm		
11	1/8"	M6	20	083810401
14	1/4"	M6	20	083810402
18	3/8"	M6	20	083810403
22	1/2"	M6	20	083810404
27	3/4"	M6	20	083810405
34	1"	M6	20	083810406
43	1 1/4"	M6	20	083810407
49	1 1/2"	M8	10	083810408
61	2"	M8	10	083810409
77	2 1/2"	M8	10	083810410
89	3"	M8	10	083810412
115	4"	M8	10	083810413
168	6"	M10	1	083810416
220	8"	M10	1	083810418

8279

Genovese chains
for static connections,
AISI 304 stainless steel



TECHNICAL DATA

- safety factor: 4
- AVAILABLE CERTIFICATES
- Technical product specifications
- Test report UNI EN10204 type 2.2

Ø mm	nr	WFL		
		kg	m	
2	13	20	50	1 082790020
3	17	55	50	1 082790030
4	19	100	50	1 082790040
5	21	250	40	1 082790050
6	23	310	30	1 082790060

Caution: product NOT designed for lifting purposes

8293

ratchet tie downs AISI 304
high-tenacity polyester belt, LC 300 kg,
with hooks

hangable



L	L2	L1	STF		
m	mm	mm	daN		
6	5700	300	100	1	082930106

LC = 300 kg

8297C

ratchet tie downs,
with mini-ratchets, AISI 304
high-tenacity polyester belt, LC 700 kg

hangable

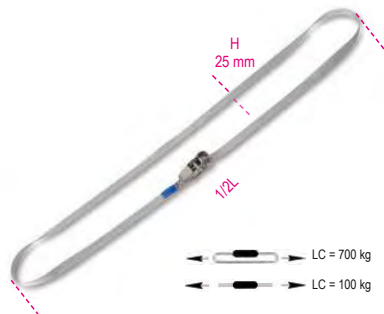

L	H		
m	mm		
5	25	1	082970350

8297F

2 cam buckle straps,
AISI 304,
high-tenacity polyester belt, LC 250 kg

hangable

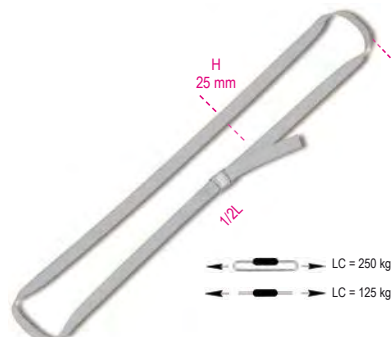

L	H		
m	mm		
3	25	1	082970230

LC = 250 kg

POLYESTER SLINGS

TECHNICAL DATA

- safety factor: 7
- traceability code
- LABORATORY TESTS
- tensile test

AVAILABLE CERTIFICATES

- Technical product specifications
- Test report UNI EN10204 type 2.2
- Manufacturer's Certificate UNI EN1492
- CE Declaration of Conformity

				$\beta=0^\circ+45^\circ$	$\beta=45^\circ+60^\circ$
30	1 t	0,8 t	2 t	1,4 t	1 t
60	2 t	1,6 t	4 t	2,8 t	2 t
90	3 t	2,4 t	6 t	4,2 t	3 t
120	4 t	3,2 t	8 t	5,6 t	4 t
150	5 t	4,0 t	10 t	7,0 t	5 t
180	6 t	4,8 t	12 t	8,4 t	6 t
240	8 t	6,4 t	16 t	11,2 t	8 t
300	10 t	8,0 t	20 t	14,0 t	10 t

8150

lifting web slings, purple 1t
two layers with reinforced eyes
high-tenacity polyester (PES) belt

CE



UNI EN 1492-1

L	H	WLL		
m	mm	ton		
0,5	30	1	1	081500005
1	30	1	1	081500010
1,5	30	1	1	081500015
2	30	1	1	081500020
2,5	30	1	1	081500025
3	30	1	1	081500030
4	30	1	1	081500040
5	30	1	1	081500050
6	30	1	1	081500060
8	30	1	1	081500080



8153

lifting web slings, green 2t
two layers with reinforced eyes
high-tenacity polyester (PES) belt

CE



UNI EN 1492-1

L m	H mm	WLL ton	
1	60	2	1 081530010
1,5	60	2	1 081530015
2	60	2	1 081530020
2,5	60	2	1 081530025
3	60	2	1 081530030
4	60	2	1 081530040
5	60	2	1 081530050
6	60	2	1 081530060
8	60	2	1 081530080
10	60	2	1 081530100

8156

lifting web slings, yellow 3t
two layers with reinforced eyes
high-tenacity polyester (PES) belt

CE

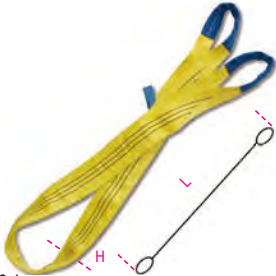

UNI EN 1492-1

L m	H mm	WLL ton	
1	90	3	1 081560010
1,5	90	3	1 081560015
2	90	3	1 081560020
2,5	90	3	1 081560025
3	90	3	1 081560030
4	90	3	1 081560040
5	90	3	1 081560050
6	90	3	1 081560060
8	90	3	1 081560080
10	90	3	1 081560100
12	90	3	1 081560120

8157

lifting web slings, grey 4t
two layers with reinforced eyes
high-tenacity polyester (PES) belt

CE



UNI EN 1492-1

L m	H mm	WLL ton	
2	120	4	1 081570020
3	120	4	1 081570030
4	120	4	1 081570040
5	120	4	1 081570050
6	120	4	1 081570060
8	120	4	1 081570080
10	120	4	1 081570100
12	120	4	1 081570120

8158

lifting web slings, red 5t
two layers with reinforced eyes
high-tenacity polyester (PES) belt

CE



UNI EN 1492-1

L m	H mm	WLL ton	
2	150	5	1 081580020
3	150	5	1 081580030
4	150	5	1 081580040
5	150	5	1 081580050
6	150	5	1 081580060
8	150	5	1 081580080
10	150	5	1 081580100
12	150	5	1 081580120

8159

lifting web slings, brown 6t
two layers with reinforced eyes
high-tenacity polyester (PES)

CE



UNI EN 1492-1

L m	H mm	WLL ton	
2	180	6	1 081590020
3	180	6	1 081590030
4	180	6	1 081590040
5	180	6	1 081590050
6	180	6	1 081590060
8	180	6	1 081590080
10	180	6	1 081590100

8160

lifting web slings, blue 8t
two layers with reinforced eyes
high-tenacity polyester (PES)

CE



UNI EN 1492-1

L m	H mm	WLL ton	
3	240	8	1 081600030
4	240	8	1 081600040
5	240	8	1 081600050
6	240	8	1 081600060
8	240	8	1 081600080
10	240	8	1 081600100

8161

lifting web slings, orange 10t
two layers with reinforced eyes
high-tenacity polyester (PES)

CE

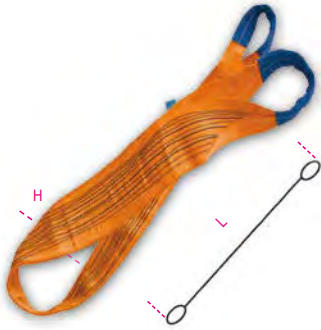

UNI EN 1492-1

L m	H mm	WLL ton		
3	300	10	1	081610030
4	300	10	1	081610040
5	300	10	1	081610050
6	300	10	1	081610060
8	300	10	1	081610080
10	300	10	1	081610100
12	300	10	1	081610120

8170

lifting round slings, purple 1t
high-tenacity polyester (PES) belt

CE



UNI EN 1492-2

L m	WLL ton	H mm		
0,5	1	45	1	081700010
1	1	45	1	081700020
1,5	1	45	1	081700030
2	1	45	1	081700040
3	1	45	1	081700060
4	1	45	1	081700080
5	1	45	1	081700100



8173

lifting round slings, green 2t
high-tenacity polyester (PES) belt

CE



UNI EN 1492-2

L m	H mm	WLL ton		
0,5	50	2	1	081730010
1	50	2	1	081730020
1,5	50	2	1	081730030
2	50	2	1	081730040
2,5	50	2	1	081730050
3	50	2	1	081730060
4	50	2	1	081730080
5	50	2	1	081730100
6	50	2	1	081730120
8	50	2	1	081730160

8176

lifting round slings, yellow 3t
high-tenacity polyester (PES) belt

CE



UNI EN 1492-2

L m	H mm	WLL ton		
1	60	3	1	081760020
1,5	60	3	1	081760030
2	60	3	1	081760040
2,5	60	3	1	081760050
3	60	3	1	081760060
4	60	3	1	081760080
5	60	3	1	081760100
6	60	3	1	081760120
8	60	3	1	081760160

8177

lifting round slings, grey 4t
high-tenacity polyester (PES) belt

CE



UNI EN 1492-2

L m	H mm	WLL ton		
1	65	4	1	081770020
1,5	65	4	1	081770030
2	65	4	1	081770040
2,5	65	4	1	081770050
3	65	4	1	081770060
4	65	4	1	081770080
5	65	4	1	081770100
6	65	4	1	081770120
8	65	4	1	081770160

8178

lifting round slings, red 5t
high-tenacity polyester (PES) belt

CE

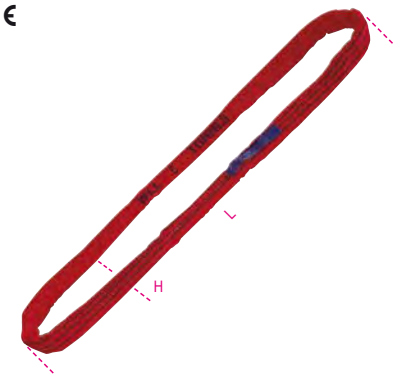

UNI EN 1492-2

L m	H mm	WLL ton		
1	70	5	1	081780020
1,5	70	5	1	081780030
2	70	5	1	081780040
2,5	70	5	1	081780050
3	70	5	1	081780060
4	70	5	1	081780080
5	70	5	1	081780100
6	70	5	1	081780120
8	70	5	1	081780160





8179M

lifting round slings, brown 6t
high-tenacity polyester (PES) belt

CE

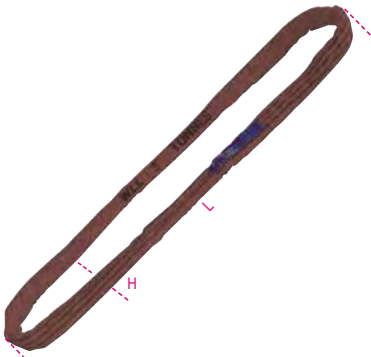

UNI EN 1492-2

L m	H mm	WLL ton		
3	80	6	1	081790060
4	80	6	1	081790080
6	80	6	1	081790120
8	80	6	1	081790160

8179B

lifting round slings, blue, 8 t,
high-tenacity polyester (PES) belt

CE

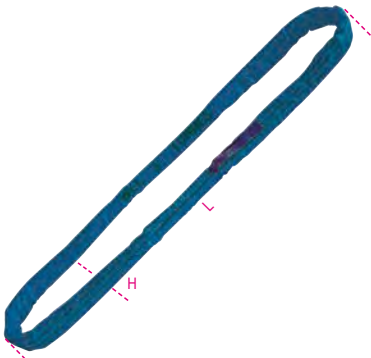

UNI EN 1492-2

L m	H mm	WLL ton		
1	85	8	1	081790220
3	85	8	1	081790260
4	85	8	1	081790280
6	85	8	1	081790320
8	85	8	1	081790360

8179A

lifting round slings, orange, 10 t,
high-tenacity polyester (PES) belt

CE

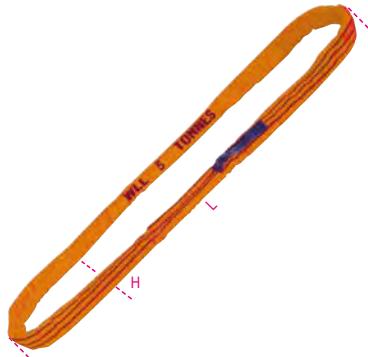

UNI EN 1492-2

L m	H mm	WLL ton		
3	95	10	1	081790506
4	95	10	1	081790508
6	95	10	1	081790512
8	95	10	1	081790516
10	95	10	1	081790520

8090F

lifting connecting links for polyester slings,
alloy steel, painted

CE

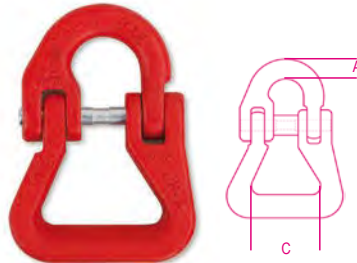

EN 1677-1

TECHNICAL DATA

- safety factor: 4
- heat treatment: hardening and tempering
- traceability code
- LABORATORY TESTS
- chemical analysis, metallographic analysis
- proof load test (WLL x 2.5)
- tensile test
- fatigue test (min. 20,000 cycles)
- AVAILABLE CERTIFICATES
- Technical product specifications
- Test report UNI EN10204 type 2.2
- Inspection certificate UNI EN10204 type 3.1
- CE Declaration of Conformity

WLL kg	Ø mm	A mm	C mm		
2000	7-8	10,5	40	1	080900220
3150	10	12	50	1	080900232
5300	13	17	60	1	080900253
8000	16	21	75	1	080900280



8166

anti-abrasion sheaths for slings,
high-tenacity polyester (PES),
with elastomer underlayer



H mm	ø mm	L m		
70	45	3	1	081660073
80	52	3	1	081660083
110	70	3	1	081660103
155	100	3	1	081660153
170	110	3	1	081660170
235	150	4	1	081660235

H mm			
70	8150	8170-8173	081660073
80	8153	8176	081660083
110	8153-8156	8177-8178	081660103
155	8157	8178-8179A 8179B-8179M	081660153
170	8158	-	081660170
235	8159	-	081660235

RATCHET TIE DOWNS

TECHNICAL DATA

- safety factor: 2
- traceability code

LABORATORY TESTS

- ratchet pretensioning test
- metal parts deformation test
- complete system tensile test
- AVAILABLE CERTIFICATES
- Technical product specifications
- Test report UNI EN10204 type 2.2

8180

ratchet tie down with single hook, LC 750kg
high-tenacity polyester (PES) belt

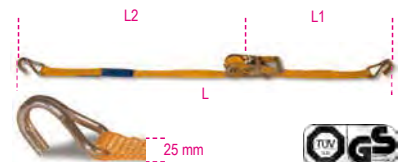

EN 12195-2

L m	L2 mm	L1 mm		
4	3750	250	1	081800004
6	5750	250	1	081800006
8	7750	250	1	081800008

LC = 750 kg

8181

ratchet tie down with single hook, LC 1000kg
high-tenacity polyester (PES) belt

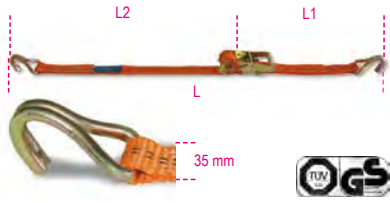

EN 12195-2

L	L2	L1		
m	mm	mm		
4	3600	400	1	081810004
6	5600	400	1	081810006
8	7600	400	1	081810008

LC = 1000 kg

8181S

ratchet tie down with double hook, LC 1000kg,
high-tenacity polyester (PES) belt

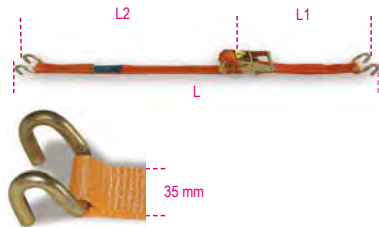

EN 12195-2

L	L2	L1	STF	
m	mm	mm	daN	
6	5600	400	180	1 081810206

LC = 1000 kg

8182T

ratchet tie down with double hook, LC 1500kg,
high-tenacity polyester (PES) belt

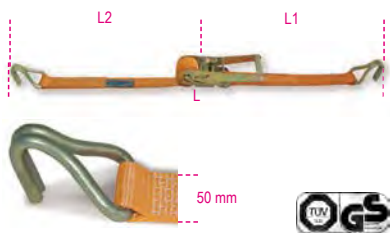

EN 12195-2

L	L1	L2		
m	mm	mm		
8,5	400	8100	1	081821085
10,5	400	10100	1	081821105

LC = 1500 kg

8182

ratchet tie down with single hook, LC 2000kg
high-tenacity polyester (PES) belt

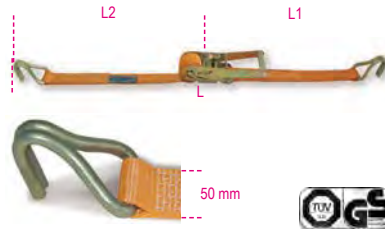

EN 12195-2

L	L2	L1		
m	mm	mm		
4,5	4100	400	1	081820045
6,5	6100	400	1	081820065
8,5	8100	400	1	081820085
10,5	10100	400	1	081820105
14,5	14100	400	1	081820145
16,5	16100	400	1	081820165

LC = 2000 kg

	L2	L1		
	mm	mm		
8182LP long part	8100		1	081820902
8182SP short part		400	1	081820905

8182H

ratchet tie down with single hook, LC 2500kg,
high-tenacity polyester (PES) belt

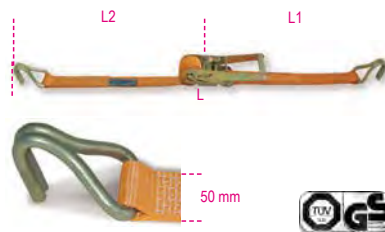

EN 12195-2

L	L1	L2		
m	mm	mm		
6,5	400	6100	1	081820406
8,5	400	8100	1	081820408
10,5	400	10100	1	081820410
14,5	400	14100	1	081820414

LC = 2500 kg

8182TS

ratchet tie down with single hook, LC 1500kg,
high-tenacity polyester (PES) belt

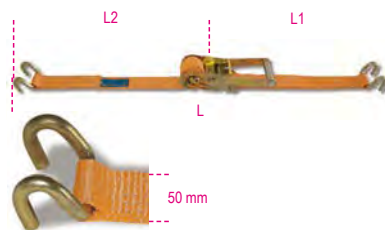

EN 12195-2

L	L1	L2		
m	mm	mm		
8,5	400	8100	1	081821285
10,5	400	10100	1	081821305

LC = 1500 kg

8182S

ratchet tie down with double hook, LC 2000kg
high-tenacity polyester (PES) belt

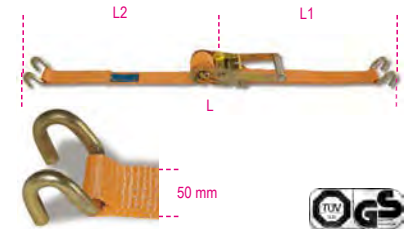

EN 12195-2

L	L2	L1		
m	mm	mm		
6,5	6100	400	1	081820265
8,5	8100	400	1	081820285
10,5	10100	400	1	081820305

LC = 2000 kg

	L2	L1		
	mm	mm		
8182SLP long part	8100		1	081820912
8182SSP short part		400	1	081820915

8184

reverse ratchet tie down, long lever, with single
hook, LC 2500 kg,
high-tenacity polyester (PES) belt



EN12195-2

L	L2	L1	STF	
m	mm	mm	daN	
6,5	6100	400	500	1 081840065
8,5	8100	400	500	1 081840085
10,5	10100	400	500	1 081840105

LC = 2500 kg

8183

ratchet tie down with single hook, LC 5000 kg,
high-tenacity polyester (PES) belt



EN 12195-2

L	L2	L1	STF	
m	mm	mm	daN	
8,5	8000	500	500	1 081830085
12,5	12000	500	500	1 081830125

LC = 5000 kg

8190

ratchet load binder with 2 hooks
Grade 8



EN12195/3

TECHNICAL DATA

- Safety factor: 2
- Heat treatment: hardening and tempering
- Traceability code

AVAILABLE CERTIFICATES

- Technical product specifications
- Test report UNI EN10204 type 2.2
- Inspection certificate UNI EN10204 type 3.1

Ø mm	LC daN	Ø mm	LC daN	1	081900010
10	6300	8	4000		

* CAUTION: The product can be used with an 8-mm chain, provided WLL is reduced (LC 4000 daN)

8190B

lashing chains



EN12195/3

TECHNICAL DATA

- Safety factor: 2
- Heat treatment: hardening tempering
- Chain-sling identification tag

ATTACHED CERTIFICATES

- Manufacturer's Certificate
- ### AVAILABLE CERTIFICATES
- Technical product specifications
 - Test report UNI EN 10204 type 2.2

Ø mm	LC daN	L m	L1 m	1	081901308
8	4000	3,5	3,30		
10	6300	3,5	3,28		

Robur

8182A

ratchet tie downs with 2 eyes,
high-tenacity polyester (PES) belt,
LC 2000 kg



EN 12195-2

L m	L2 mm	L1 mm	STF daN	1	081820585
8,5	8100	400	300		

LC = 2000 kg

8182E

ratchet tie downs for van and truck interiors,
LC 1000 kg,
high-tenacity polyester (PES) belt



EN 12195-2

L m	L2 mm	L1 mm	H mm	1	081820440
4	3500	500	50		

LC = 1000 kg

	L2 mm	L1 mm	1	081820942
8182EL	2500			
8182EC		1500		

8185

ring ratchet tie down, LC 1500kg
high-tenacity polyester (PES) belt



EN 12195-2

L m	STF daN	1	081850005
5	200		
8	200		

8186

ring ratchet tie down, LC 2000kg
high-tenacity polyester (PES) belt



EN 12195-2

L m	STF daN	1	081860005
5	180		
8	180		

8187

ring ratchet tie down, LC 4000kg
high-tenacity polyester (PES) belt



EN 12195-2

L m	STF daN	1	081870005
5	350		
8	350		

8188C

ring ratchet tie downs, LC 750 kg,
high-tenacity polyester (PES) belt



EN 12195-2

L m	STF daN		
1,5	72	3	081880315
5	72	3	081880350

8188CG/25

ratchet tie downs with S-hooks and Eyes,
LC 400 kg
high-tenacity polyester (PES) strap



EN 12195-2

L m	L1 mm	L2 mm		
3	480	170	1	081880430
5	480	170	1	081880450

8188CU/25

ratchet tie downs with single hooks,
LC 400 kg,
high-tenacity polyester belt (PES)



EN 12195-2

L m	L1 mm	L2 mm		
5	300	4700	1	081880750

8188F

cam buckle straps, LC 200 kg,
high-grade polypropylene (PP) belt

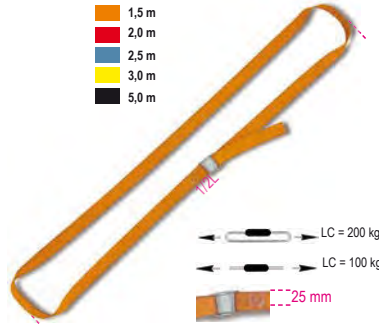
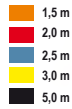

EN 12195-2

L m			
1,5	10	081880215	
2,0	10	081880220	
2,5	10	081880225	
3,0	10	081880230	
5,0	6	081880250	

8188F35

cam buckle straps, LC 500 kg,
high-tenacity polypropylene (PP) belt



EN 12195-2

L m			
5	1	081880295	

8188VFG2

cam buckle strap with S-hooks and Eyes,
LC 250 kg
high-grade polypropylene (PP) belt



EN 12195-2

L m	L1 mm	L2 mm		
3	450	110	1	081881530

8189

polyester belt (PES)
for ratchet tie downs



H mm	L m	LC kg		
25	100	750	1	081890902
35	100	1000	1	081890903
50	100	2000	1	081890905

8189A

non-slip mat
for fixing loads



L m	H mm	S mm	μ		
5	250	8	0,6	1	081890525

8189PA

2 angular guards
for polyester belts

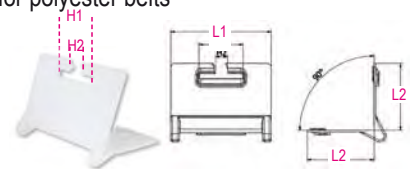

L1xL2 mm	H1 mm	H2 mm		
100x60	60	12	1	081890060
135x90	60	18	1	081890090

Robur

Item	Test Report 2.2 (UNI EN 10204)	Test Certificate 3.1(UNI EN 10204)	Manufacturer's Certificate	CE Declaration of Conformity
8001Z	✓	✓		✓
8001TZ	✓	✓		✓
8002ZD	✓			
8003ZD	✓			
8004ND	✓			
8005Z	✓			✓
8005TZ	✓			✓
8006Z	✓			✓
8007Z	✓			✓
8008N	✓			✓
8008TZN	✓			✓
8009FD	✓			
8009Z	✓			✓
8009TZ	✓			✓
8010Z	✓			✓
8010TZ	✓			
8016	✓			✓
8016DA	✓			✓
8016FR	✓			
8016U2	✓		✓	✓
8016UGK	✓		✓	✓
8018E	✓			
8018T	✓			
8020	✓			
8021	✓			
8025	✓	✓		✓
8026A	✓	✓		✓
8026R	✓	✓		✓
8028	✓	✓		✓
8029R	✓	✓		✓
8031R	✓	✓		✓
8032	✓	✓		✓
8040EN	✓	✓		✓
8040EZ	✓	✓		✓
8042EN	✓	✓		✓
8042EZ	✓	✓		✓
8041	✓	✓		✓
8043	✓	✓		✓
8044	✓	✓		✓
8048	✓			
8049	✓	✓		✓
8049A	✓	✓		✓
8051S	✓	✓		✓
8052	✓	✓		✓
8057R	✓	✓		✓
8058R	✓	✓		✓
8060R	✓	✓		✓
8061R	✓	✓		✓
8062	✓	✓		✓
8063	✓	✓		✓
8064S	✓	✓		✓
8065SC	✓	✓		✓
8074	✓			
8074A	✓			
8074G	✓			
8080	✓			
8085R	✓	✓		✓
8086	✓	✓		✓
8090	✓	✓		✓
8090F	✓	✓		✓
8090R	✓	✓		✓
8091			✓	✓
8091SL			✓	✓

Item	Test Report 2.2 (UNI EN 10204)	Test Certificate 3.1(UNI EN 10204)	Manufacturer's Certificate	CE Declaration of Conformity
8092			✓	✓
8092SL			✓	✓
8094			✓	✓
8094SL			✓	✓
8096			✓	✓
8096SL			✓	✓
8097			✓	✓
8097SL			✓	✓
8098			✓	✓
8098SL			✓	✓
8100	✓	✓		✓
8105	✓	✓		✓
8109	✓	✓		✓
8110	✓			
8114	✓			
8116	✓			
8120	✓			
8120B	✓			
8130A	✓			
8139DL	✓			
8143	✓		✓	✓
8146	✓		✓	✓
8146K	✓		✓	✓
8150	✓		✓	✓
8153	✓		✓	✓
8156	✓		✓	✓
8157	✓		✓	✓
8158	✓		✓	✓
8159	✓		✓	✓
8160	✓		✓	✓
8161	✓		✓	✓
8166	✓			
8170	✓		✓	✓
8173	✓		✓	✓
8176	✓		✓	✓
8177	✓		✓	✓
8178	✓		✓	✓
8179M-B-A	✓		✓	✓
8180	✓			
8181	✓			
8181S	✓			
8182	✓			
8182A	✓			
8182E	✓			
8182H	✓			
8182M	✓			
8182S	✓			
8182T	✓			
8182T-TS	✓			
8182TS	✓			
8185	✓			
8186	✓			
8187	✓			
8188C	✓			
8188CG/25	✓			
8188CU	✓			
8188F	✓			
8188VF/35	✓			
8188FG2	✓			
8190	✓	✓		
8190B	✓		✓	
8302Z	✓			
8303Z	✓			

Item	Test Report 2.2 (UNI EN 10204)	Test Certificate 3.1(UNI EN 10204)	Manufacturer's Certificate	CE Declaration of Conformity
8317DZ	✓			
8317SZ	✓			
8381SL	✓			
8381SP	✓			
8383C	✓			
8383P	✓			
8515V	✓			
8515Z	✓			
8531	✓			
8532	✓			
8535	✓			
8201T	✓			
8205	✓			
8206	✓			
8207	✓			
8209	✓			
8210	✓			
8216	✓			✓
8220	✓			
8225	✓			
8227	✓			
8228	✓			
8240	✓			
8240F	✓	✓		✓
8242	✓			
8242F	✓	✓		✓
8248	✓			
8249	✓			
8249G	✓			
8250	✓			
8264	✓			
8267	✓			
8272	✓			
8273	✓			
8274	✓			
8274A	✓			
8274G	✓			
8276	✓			
8276G	✓			
8278	✓			
8280	✓			
8282	✓			
8282S	✓			
8284	✓			
8285	✓			
8286	✓			
8287	✓			
8290	✓			
8293	✓			
8297C	✓			
8297F	✓			
8381SX	✓			



Beta Collection



A range of exclusive products designed and developed to epitomize Beta's character, it comprises over 200 original, first-rate items: sports equipment, technical clothing and a variety of tailored objects. An ideal medium for promotional actions, a must for recreational moments.



9500TL

softshell jacket, made of 100% polyester, 320 g/m², three-layered, microfibre outer shell, waterproof, breathable intermediate membrane, fleece interior



Size	Quantity	Product Code
S	1	095000051
M	1	095000052
L	1	095000053
XL	1	095000054
XXL	1	095000055

9501TLD

women's sweatshirt, made of cotton (80%) and polyester (20%), 320 g/m²



Size	Quantity	Product Code
S	1	095010061
M	1	095010062
L	1	095010063
XL	1	095010064

9501TL

men's sweatshirt, made of cotton (80%) and polyester (20%), 320 g/m²



Size	Quantity	Product Code
S	1	095010051
M	1	095010052
L	1	095010053
XL	1	095010054
XXL	1	095010055

9502TL
polo shirt, 100% pique cotton, 210 g/m²



S	1	095020051
M	1	095020052
L	1	095020053
XL	1	095020054
XXL	1	095020055

9503TL
t-shirt, 100% jersey cotton, 160 g/m²



S	1	095030051
M	1	095030052
L	1	095030053
XL	1	095030054
XXL	1	095030055

9504TL
jacket with 100% polyester exterior, waterproof treatment



S	1	095040051
M	1	095040052
L	1	095040053
XL	1	095040054
XXL	1	095040055

9505TL
sleeveless jacket with 100% polyester exterior, waterproof treatment, padding 100 g/m², interior pocket



S	1	095050051
M	1	095050052
L	1	095050053
XL	1	095050054
XXL	1	095050055

9572MB
Beta-March F1 vintage T-shirt, 100% cotton



S	1	095720701
M	1	095720702
L	1	095720703
XL	1	095720704
XXL	1	095720705

9508TL
waterproof jacket, 100% polyester, folds into pocket



S	1	095080051
M	1	095080052
L	1	095080053
XL	1	095080054
XXL	1	095080055

9510
short-sleeved shirt, 100% poplin cotton, 110 g/m², orange fabric inserts and white piping trim, contrasting orange button, reflective heart-side logo and back print



XS	1	095100000
S	1	095100001
M	1	095100002
L	1	095100003
XL	1	095100004
XXL	1	095100005

9533N
polyester shirt, breathable, 175 g/m², black



S	1	095330051
M	1	095330052
L	1	095330053
XL	1	095330054
XXL	1	095330055

9534W
three-button polo shirt, carded pique cotton 220 g/m², white



S	1	095340011
M	1	095340012
L	1	095340013
XL	1	095340014
XXL	1	095340015

9534B
three-button polo shirt,
carded pique cotton 200 g/m², blue



S	1	095340051
M	1	095340052
L	1	095340053
XL	1	095340054
XXL	1	095340055

9537TL
fleece pullover, 100% polyester



S	1	095370051
M	1	095370052
L	1	095370053
XL	1	095370054
XXL	1	095370055

9580S
sunglasses "Summer" style

CE



EN ISO 12312-1:2013+A1:2015
UV400
FILTER CAT. III

9580S 1 095800100

Beta
Quality Tools

9593S
smartwatch, touchscreen, fitness tracker,
silicone strap



9593S 1 095930200

9593M
automatic watch, steel case, 5 ATM water
resistant, steel wristband



9593M 1 095930120

9593A
chronograph, steel case, 5 ATM water
resistant, silicone strap



9593A 1 095930050

9593W
analogue watch, soft touch plastic case with
metal ring, 3 ATM water resistant, silicone
strap



9593W 1 095930150

9544C
cabin-size trolley with 4 double wheels, TSA
lock, USB port + 3.5-mm jack



9544C 1 095440101

9557J 2.0
bag made of coated polyester/Oxford 600D
polyester fabric, dimensions 47x28x25 cm



9557J 2.0 1 095570020

9557J 3.0
bag made of coated polyester/Oxford 600D,
dimensions 58x29x36 cm



9557J 3.0 1 095570030



9557N

"Racing" bag, made from waterproof PVC coated fabric



cm
80x35x35 1 095570001

9541F

rucksack made of coated polyester/Oxford 600D polyester fabric, dimensions 50x33x16 cm



9541F 1 095410011

9541S

Rucksack with casing, made of waterproof 210D polyester, 33x45 cm



9541S 1 095410031

9541BIKE

rucksack made of Oxford polyester, dimensions 41x24x16 cm



9541BIKE 1 095410021

95740

work gloves, with stretch-elastic cuffs, reinforced thumbs and index fingers, made from touchscreen capable synthetic leather



M	1 095740202
L	1 095740203
XL	1 095740204
XXL	1 095740205

9574B

work gloves, with stretch-elastic cuffs, reinforced thumbs and index fingers, made from touchscreen capable synthetic leather



M	1 095740102
L	1 095740103
XL	1 095740104
XXL	1 095740105

9525TL

Top Line cap



9525TL 1 095250010

9525BB

bike cap



9525BB 1 095250020

9525F

flat visor cap



9525F 1 095250099

9525/N

cap, 100% cotton, one-size-fits-all adjustable buckle strap, directly embroidered front, sides and back, black



9525N 5 095251021

9525/B

cap, 100% cotton, one size-fits-all adjustable buckle strap, directly embroidered front, sides and back, white



9525B 5 095251031

9521

umbrella, made of nylon T210, 3-section aluminium frame, black, automatic open/close mechanism



9521 1 095210000

95210B

umbrella made of nylon 210T, diameter 100 cm



95210B 1 095210021

9599CB

Atala® city bike, 49 cm aluminium frame, Shimano® 6 speed gear, V-brake®, 28" aluminium rims



9599CB 1 095990011

9599CB-W

Atala® city bike, aluminium frame, Shimano® 6-speed gear, V-Brakes®, 28" aluminium rims



9599CB-W 1 095990023

9598W

Whistle® mountain bike, aluminium frame, Suntour XCT fork, Shimano Acera 7 speed gear (14-28), disc brakes and 29" aluminium rims



9598W M 1 095980110
9598W L 1 095980112

9598WHP

Whistle® mountain bike, aluminium frame, Suntour XCM remote lockout fork, Shimano Deore XT 12 speed gear, hydraulic Shimano brakes and 29" aluminium rims



9598WHP M 1 095980120
9598WHP L 1 095980122

9515M

technical jersey, made from quick-dry, breathable fabric; side mesh inserts



S 1 095150051
M 1 095150052
L 1 095150053
XL 1 095150054
XXL 1 095150055
XXXL 1 095150056

9516B

shorts made from quick-dry, breathable Lycra, 180 g/m², with elastic waistband for improved fit



S 1 095160051
M 1 095160052
L 1 095160053
XL 1 095160054
XXL 1 095160055
XXXL 1 095160056

9539CB

protective road and mountain bike cycling helmet with detachable chin guard - adjustable sizes



S-M 1 095390010
L-XL 1 095390011

9542M

short-sleeved jersey, breathable microfibre fabric, long, covered zip, three rear pockets, including one with zip, silicone elastic at jersey end



S 1 095420051
M 1 095420052
L 1 095420053
XL 1 095420054
XXL 1 095420055
XXXL 1 095420056

9542C

Lycra bib shorts, silicone elastic at leg end, antibacterial seat padding



S 1 095420061
M 1 095420062
L 1 095420063
XL 1 095420064
XXL 1 095420065
XXXL 1 095420066



9542GW

winter jacket, made from highly breathable, winder breaker fabric and raised fabric; long zip, silicone-free elastic waistband; close-fitting Lycra cuffs; refractive rear inserts; 3 exterior rear pockets, including 1 with zip



SIZE	QTY	SKU
S	1	095420101
M	1	095420102
L	1	095420103
XL	1	095420104
XXL	1	095420105
XXXL	1	095420106

9542G

winter jersey, breathable fabric, raised inside, long zip, three rear pockets, silicone elastic at jersey end



SIZE	QTY	SKU
S	1	095420012
M	1	095420013
L	1	095420014
XL	1	095420015
XXL	1	095420016
XXXL	1	095420017



9542S

winter underpants, raised Lycra, antibacterial, high-breathability seat padding



SIZE	QTY	SKU
S	1	095420022
M	1	095420023
L	1	095420024
XL	1	095420025
XXL	1	095420026
XXXL	1	095420027

9542AT

sleeveless wind stopper jacket, breathable bound fabric, long zip



SIZE	QTY	SKU
S	1	095420072
M	1	095420073
L	1	095420074
XL	1	095420075
XXL	1	095420076
XXXL	1	095420077

9542AL

waterproof windbreaker, long-sleeved, made of breathable fabric



SIZE	QTY	SKU
S	1	095420042
M	1	095420043
L	1	095420044
XL	1	095420045
XXL	1	095420046
XXXL	1	095420047

9543C

tubular neck scarf, multipurpose, 100% polyester microfibre, seamless



SKU	SIZE	QTY	SKU
9543C	cm	25x50	1 095430100

9528B

Polyethylene flask, 500 ml



SKU	QTY	SKU
9528B	1	095280005

9597P

column pump with gauge



SKU	QTY	SKU
9597P	1	095970100



9524SC

miniature Beta garage for collectors



1:18

1 095240018

9548KB

balance bike, aluminium frame, 12" wheel with inner tube; recommended for children from 3 years; maximum weight: 30 kg



9548KB

1 095480110

9547WSK

"Kinder Work Station", workbench with tools, for children from 3 years of age



74 cm

9547WSK

1 095473801

9547T

"Kinder trolley", tool trolley, for children from 3 years of age, complete with tools



9547T

1 095470100

9548G

"Kinder Garage", 6-storey, with car wash, lift and ramps



69 cm

9548G

1 095480100

9561V 2,5

sail flag 2.5x0.50 m with aluminium pole, cross base with weighted ring



9561V 2,5

1 095610200

9561VV 2,5

sail flag, 2x0.50 m, with pole



9561VV 2,5

1 095610201

9561VW

sail flag, 3.50x0.75 m, with pole



9561VW

1 095610101

9561V

sail flag, 4x0.75 m, with chrome-plated metal pole, grit concrete base, 50 cm



9561V

1 095610001

9559

one-sided banner, TNT; modules: 3x0.8 m



9559

1 095591001

9559/30MT

nonwoven fabric roll of 10 Beta logos



9559/30MT

1 095591031

9590B

flag, made of screen-printed nylon



9590B

1 095900000





9577M

overalls, T/C twill, polyester/cotton (65/35), 240 g/m2



S	1	095770051
M	1	095770052
L	1	095770053
XL	1	095770054
XXL	1	095770055
XXXL	1	095770056

9579C

work jacket, polyester/cotton



M	1	095791002
L	1	095791003
XL	1	095791004

9565BBQ

sheet steel barbecue drum with grill, brazier and lid complete with locking clamp

Chromium-plated steel grill (compliant with Italian Ministerial Decree of 21/03/73 and Regulation (EC) 1935/2004 on food contact materials), with handles and feet



9565BBQ 1 095650100

h 88 cm - ø 59 cm

9565T

sheet steel table drum with varnished multi-ply birch top

Supplied with a double KIT of spacing tubes (7 cm or 20 cm) for vertical adjustment.



9565T 1 095650200

h 95→108 cm - ø 70 cm

9565S

sheet steel drum with seat made of removable imitation leather



9565S 2 095650300

h 60 cm - ø 38 cm

9565ICE

sheet steel ice drum with lid and non-scratch container, certified for food use

Interior of drum is coated with antirust, water-resistant paint. Storage container can accommodate ice and bottles/cans to cool.



9565ICE 1 095650400

h 60 cm - ø 38 cm

9565K

drum table with two seats



9565K 1 095650500

9563G

office armchairs, for guests



9563G 1 095630050

9563U

office armchair, ergonomic



9563U

1 095630020

9549BP

portable battery, 10000mAh



9549BP

1 095490052

9549C

USB key, 32 GB



9549C

1 095490062

9547

desk calculator



9547

1 095470000

Beta
Quality Tools

9594

clock complete with thermometer and hygrometer, 26 cm in diameter



∅
cm
26

1 095940051

9526P

capsule espresso coffee machine.
(capsules not included)
Compatible with Lavazza™ and Espresso Point™ capsules for professional use



9526P

1 095260010

9527 6T

set of 6 coffee cups



9527 6T

1 095270001

9527MUG

mug with cover and silicone sleeve



9527MUG

1 095270020

9522A

bottle opener with ergonomic handle



9522A

1 095220010

9523A

aluminium flask, 500 ml



9523A

1 095230005

9586K

multipurpose steel knife, 10 functions



9586K

1 095860100

9526RMN

set of 2 packs of 55 rummy playing cards by Modiano®



9526RMN

1 095260001

9592B/C50

set of 50 pens



9592B/C50

1 095920050

Beta

9592B/P
customised pens



9592B/P 500 095920051

9592MB
Parker® ballpoint pen



9592MB 1 095920060

9592M/50
set of 50 pencils



9592M/50 1 095920100

9588M
soft foam tray with 1 pen and 2 notebooks



9588M 1 095880011

9596
badge holder, polyester, with metal clip
and mobile phone string



9596 10 095961001



9595C
leather key ring



9595C 1 095950011

9595T
metal chrome-plated key ring, in velvet pouch



9595T 1 095950021

9595 C25
metal chrome-plated key ring with rubber hook



9595 C25 1 095950031

9569P
shopper, made of polyethylene,
folded sides



9569P 44x34 50 095691001

9569S
TNT shopper with folded sides, 38x42 cm



9569S 38x42 50 095690051

9569MS-2
shopper, made of hard-wearing polypropylene



9569MS-2 45x40 5 095690055

9569MS
shopper, made of hard-wearing polypropylene,
with double handles



9569MS 60x40 5 095690052

9587 9x14
notebook, 9x14 cm



9587 9x14 5 095870009



9587 13x21

notebook, 13x21 cm



9587 13X21

5 095870013

9588S/10...

set of 10 notepads



9588S/10A

21x29 cm

1 095881001

9588S/10B

15x21 cm

1 095881002

9588S/10C

10x15 cm

1 095881003

9588S/10D

7,5x10,5 cm

1 095880054

9588/10PI

set of 10 notepads with adhesive sheets



9588S/10PI

7,5x7,5 cm

1 095880055

9589A/36

pack of 36 rolls of packaging adhesive tape, with Beta logo, tawny



9589A/36

1 095890035

9589B/36

pack of 36 rolls of packaging adhesive tape, with Beta logo, white



9589B/36

1 095890036

9562TB

mat for trying on shoes, with anti-skid, rubber-coated bottom



9562TB

1 095620500

9562T2

workbench mat, 200x160 cm

- protects floor from oil and petrol leaks, environmentally friendly
- easy to clean, anti-skid, rubber-coated bottom



9562T2

1 095620200



9562T3

garage mat

Dimensions: 300x160 cm

- particularly suitable for use under motorcycle jacks
- protects floor from oil and petrol leaks, environmentally friendly
- easy to clean, anti-skid, rubber-coated bottom



9562T3

1 095620300

9562P2

multilogo mat, 200x80 cm

- particularly suitable for use with workshop equipment item C55 or under motorcycles



9562P2

1 095620400

9562P12

multilogo mat roll, 25 m x 80 cm

Allows mat length to be customized as needed



9562P12

1 095620425



ELIMINATED ITEMS - SUBSTITUTE/RECOMMENDED ITEMS

	ELIMINATED ITEM
	SUBSTITUTE ITEM
	RECOMMENDED ITEM

42/B9	000420064	42/B9	000421064
42/S17	000420065	42/S17	000421065
42/S15	000420066	42/S15	000421066
42/S14	000420067	42/S14	000421067
42/S17X	000420068	42/S17X	000421068
42/S26	000420070	42/S26	000421070
42/SP15	000420078	42/SP15	000421078
42/SP25	000420085	42/SP25	000421085
42/SC9I	000420087	42/SC9I	000421087
42/SC9E	000420088	42/SC9E	000421088
42HS 6	000424006	42HS 6	000424506
42HS 7	000424007	42HS 7	000424507
42HS 8	000424008	42HS 8	000424508
42HS 9	000424009	42HS 9	000424509
42HS 10	000424010	42HS 10	000424510
42HS 11	000424011	42HS 11	000424511
42HS 12	000424012	42HS 12	000424512
42HS 13	000424013	42HS 13	000424513
42HS 14	000424014	42HS 14	000424514
42HS 15	000424015	42HS 15	000424515
42HS 16	000424016	42HS 16	000424516
42HS 17	000424017	42HS 17	000424517
42HS 18	000424018	42HS 18	000424518
42HS 19	000424019	42HS 19	000424519
42HS 20	000424020	42HS 20	000424520
42HS 21	000424021	42HS 21	000424521
42HS 22	000424022	42HS 22	000424522
42HS 23	000424023	42HS 23	000424523
42HS 24	000424024	42HS 24	000424524
42HS 25	000424025	42HS 25	000424525
42HS 26	000424026	42HS 26	000424526
42HS 27	000424027	42HS 27	000424527
42HS 28	000424028	42HS 28	000424528
42HS 29	000424029	42HS 29	000424529
42HS 30	000424030	42HS 30	000424530
42HS 32	000424032	42HS 32	000424532
42HS 34	000424034	42HS 34	000424534
42HS 36	000424036	42HS 36	000424536
42K 5,5	000429005	42K 5,5	000429505
42K 6	000429006	42K 6	000429506
42K 7	000429007	42K 7	000429507
42K 8	000429008	42K 8	000429508
42K 9	000429009	42K 9	000429509
42K 10	000429010	42K 10	000429510
42K 11	000429011	42K 11	000429511
42K 12	000429012	42K 12	000429512
42K 13	000429013	42K 13	000429513
42K 14	000429014	42K 14	000429514
42K 15	000429015	42K 15	000429515
42K 16	000429016	42K 16	000429516
42K 17	000429017	42K 17	000429517
42K 18	000429018	42K 18	000429518
42K 19	000429019	42K 19	000429519
42K 20	000429020	42K 20	000429520
42K 21	000429021	42K 21	000429521
42K 22	000429022	42K 22	000429522
42K 23	000429023	42K 23	000429523
42K 24	000429024	42K 24	000429524
42K 25	000429025	42K 25	000429525
42K 26	000429026	42K 26	000429526
42K 27	000429027	42K 27	000429527
42K 28	000429028	42K 28	000429528
42K 29	000429029	42K 29	000429529
42K 30	000429030	42K 30	000429530
42K 32	000429032	42K 32	000429532
606MQ/25	006060702	606MQ/50	006060705
961D	009610500	961P6	009610000
961D/CF 3,8	009610511		
961D/DC 8,5	009610513		
961D/DC 5,5	009610517		
1084 140	010840004	1084 160	010840006
1084 180	010840008	1084 200	010840010
1084BM 140	010840034	1084BM 160	010840036

1084BM 180	010840038	1084BM 200	010840040
1150 160	011500006	1150 160	011500046
1150 180	011500008	1150 180	011500048
1150 200	011500010	1150 200	011500050
1150 220	011500012	1150 220	011500052
1150BM 160	011500036	1150BM 160	011500146
1150BM 180	011500038	1150BM 180	011500148
1150BM 200	011500040	1150BM 200	011500150
1150BM 220	011500042	1150BM 220	011500152
1150BM-HS 160	011504036	1150BM-HS 160	011504146
1150BM-HS 180	011504038	1150BM-HS 180	011504148
1150BM-HS 200	011504040	1150BM-HS 200	011504150
1150K 160	011509006	1150K 160	011509046
1150K 180	011509008	1150K 180	011509048
1150K 200	011509010	1150K 200	011509050
1150K 220	011509012	1150K 220	011509052
1150BMK 160	011509036	1150BMK 160	011509146
1150BMK 180	011509038	1150BMK 180	011509148
1150BMK 200	011509040	1150BMK 200	011509150
1150BMK 220	011509042	1150BMK 220	011509152
1201 2,5X50	012010003	1201E 2,5X50	012011003
1201 2,5X75	012010006	1201E 2,5X75	012011006
1201 3X75	012010009	1201E 3X75	012011009
1201 3X100	012010012	1201E 3X100	012011012
1201 3,5X75	012010018	1201E 3,5X75	012011018
1201 3,5X100	012010021	1201E 3,5X100	012011021
1201 4X100	012010030	1201E 4X100	012011030
1201 4X125	012010033	1201E 4X125	012011033
1201 4X150	012010036	1201E 4X150	012011036
1201 5,5X100	012010039	1201E 5,5X100	012011039
1201 5,5X125	012010040	1201E 5,5X125	012011040
1201 5,5X150	012010042	1201E 5,5X150	012011042
1201 6,5X100	012010048	1201E 6,5X100	012011048
1201 6,5X125	012010050	1201E 6,5X125	012011050
1201 6,5X150	012010051	1201E 6,5X150	012011051
1201 8X150	012010057	1201E 8X150	012011057
1201 8X200	012010060	1201E 8X200	012011060
1201 10X200	012010066	1201E 10X200	012011066
1201N 4X30	012010103	1201EN 4X30	012011103
1201N 6,5X30	012010106	1201EN 6,5X30	012011106
1201/S6	012010206	1201E/S6	012011206
1201DZ	012010501	1201E/DZ	012011501
1201K 2,5X50	012019003	1201E/K 2,5X50	012019203
1201K 2,5X75	012019006	1201E/K 2,5X75	012019206
1201K 3X75	012019009	1201E/K 3X75	012019209
1201K 3X100	012019012	1201E/K 3X100	012019212
1201K 3,5X75	012019018	1201E/K 3,5X75	012019218
1201K 3,5X100	012019021	1201E/K 3,5X100	012019221
1201K 4X100	012019030	1201E/K 4X100	012019230
1201K 4X125	012019033	1201E/K 4X125	012019233
1201K 4X150	012019036	1201E/K 4X150	012019236
1201K 5,5X100	012019039	1201E/K 5,5X100	012019239
1201K 5,5X125	012019040	1201E/K 5,5X125	012019240
1201K 5,5X150	012019042	1201E/K 5,5X150	012019242
1201K 6,5X100	012019048	1201E/K 6,5X100	012019248
1201K 6,5X125	012019050	1201E/K 6,5X125	012019250
1201K 6,5X150	012019051	1201E/K 6,5X150	012019251
1201K 8X150	012019057	1201E/K 8X150	012019257
1201K 8X200	012019060	1201E/K 8X200	012019260
1201K 10X200	012019066	1201E/K 10X200	012019266
1201NK 4X30	012019103	1201EN/K 4X30	012019303
1201NK 6,5X30	012019106	1201EN/K 6,5X30	012019306
1202 3X60	012020003	1202E 3X60	012021003
1202 3X100	012020006	1202E 3X100	012021006
1202 4,5X80	012020009	1202E 4,5X80	012021009
1202 4,5X120	012020012	1202E 4,5X120	012021012
1202 6X100	012020018	1202E 6X100	012021018
1202 6X150	012020021	1202E 6X150	012021021
1202 8X150	012020024	1202E 8X150	012021024
1202 9,5X200	012020027	1202E 9,5X200	012021027
1202N 4,5X30	012020103	1202EN 4,5X30	012021103
1202N 6X30	012020106	1202EN 6X30	012021106
1202/S4	012020204	1202E/S4	012021204
1202L 3X300	012020303	1202EL 3X300	012021303
1202L 4,5X300	012020305	1202EL 4,5X300	012021305
1202L 4,5X400	012020306	1202EL 4,5X400	012021306
1202L 6X400	012020309	1202EL 6X400	012021309
1202K 3X60	012029003	1202E/K 3X60	012029203
1202K 3X100	012029006	1202E/K 3X100	012029206

1202K 4,5X80	012029009	1202E/K 4,5X80	012029209
1202K 4,5X120	012029012	1202E/K 4,5X120	012029212
1202K 6X100	012029018	1202E/K 6X100	012029218
1202K 6X150	012029021	1202E/K 6X150	012029221
1202K 8X150	012029024	1202E/K 8X150	012029224
1202K 9,5X200	012029027	1202E/K 9,5X200	012029227
1202NK 4,5X30	012029103	1202EN/K 4,5X30	012029303
1202NK 6X30	012029106	1202EN/K 6X30	012029306
1203/D5	012030001	1203E/D5	012031001
1203/D5PZ	012030003	1203E/D5PZ	012031003
1203/D6	012030006	1203E/D6	012031006
1203/D7	012030007	1203E/D7	012031007
1203/D8	012030008	1203E/D8	012031008
1203/S8	012030009	1203E/S8	012031009
1203/D10	012030010	1203E/D10	012031010
1203/D10N	012030019	1203E/D10N	012031019
1203/S10	012030021	1203E/S10	012031021
1203/E1P	012030301	1203E/E1P	012031301
1203/E4P	012030304	1203E/E4P	012031304
1203/E5P	012030305	1203E/E5P	012031305
1203/E10P	012030310	1203E/E10P	012031310
1203/EV1P	012030351	1203E/EV1P	012031351
1203/EV4P	012030354	1203E/EV4P	012031354
1203/EV5P	012030355	1203E/EV5P	012031355
1203/EV10P	012030360	1203E/EV10P	012031360
1204 2,5X60	012040003	1204E 2,5X60	012041003
1204 3X75	012040006	1204E 3X75	012041006
1204 3X100	012040009	1204E 3X100	012041009
1204 4X100	012040012	1204E 4X100	012041012
1204 4X125	012040015	1204E 4X125	012041015
1204 5X125	012040018	1204E 5X125	012041018
1204 5X150	012040021	1204E 5X150	012041021
1204 6,5X150	012040024	1204E 6,5X150	012041024
1204/S5	012040205	1204E/S5	012041205
1204L 2,5X200	012040303	1204EL 2,5X200	012041303
1204L 3X300	012040306	1204EL 3X300	012041306
1204L 4X400	012040309	1204EL 4X400	012041309
1204L 5X400	012040315	1204EL 5X400	012041315
1204L 6,5X400	012040318	1204EL 6,5X400	012041318
1204K 2,5X60	012049003	1204E/K 2,5X60	012049103
1204K 3X75	012049006	1204E/K 3X75	012049106
1204K 3X100	012049009	1204E/K 3X100	012049109
1204K 4X100	012049012	1204E/K 4X100	012049112
1204K 4X125	012049015	1204E/K 4X125	012049115
1204K 5X125	012049018	1204E/K 5X125	012049118
1204K 5X150	012049021	1204E/K 5X150	012049121
1204K 6,5X150	012049024	1204E/K 6,5X150	012049124
1205ES 1,5	012050315	1205E	

ELIMINATED ITEMS - SUBSTITUTE/RECOMMENDED ITEMS

	ELIMINATED ITEM
	SUBSTITUTE ITEM
	RECOMMENDED ITEM

1207TXK 27	012079027	1207E TX/K27	012079127
1207TXK 30	012079030	1207E TX/K30	012079130
1207TXK 40	012079040	1207E TX/K40	012079140
1207TXK 45	012079045	1207E TX/K45	012079145
1208RTX 09	012080009	1208E/RTX 09	012081009
1208RTX 10	012080010	1208E/RTX 10	012081010
1208RTX 15	012080015	1208E/RTX 15	012081015
1208RTX 20	012080020	1208E/RTX 20	012081020
1208RTX 25	012080025	1208E/RTX 25	012081025
1208RTX 27	012080027	1208E/RTX 27	012081027
1208RTX 30	012080030	1208E/RTX 30	012081030
1208RTX 40	012080040	1208E/RTX 40	012081040
1208RTX/D7	012080207	1208E/RTX-D7	012081207
1208RTXK 09	012089009	1208E RTX/K09	012089109
1208RTXK 10	012089010	1208E RTX/K10	012089110
1208RTXK 15	012089015	1208E RTX/K15	012089115
1208RTXK 20	012089020	1208E RTX/K20	012089120
1208RTXK 25	012089025	1208E RTX/K25	012089125
1208RTXK 27	012089027	1208E RTX/K27	012089127
1208RTXK 30	012089030	1208E RTX/K30	012089130
1208RTXK 40	012089040	1208E RTX/K40	012089140
1209PZ 0	012090000	1209E/PZ 0	012091000
1209PZ 1	012090003	1209E/PZ 1	012091003
1209PZ 2	012090006	1209E/PZ 2	012091006
1209PZ 3	012090009	1209E/PZ 3	012091009
1209PZ 4	012090012	1209E/PZ 4	012091012
1209N/PZ 1	012090103	1209EN/PZ 1	012091103
1209N/PZ 2	012090106	1209EN/PZ 2	012091106
1209PZ/S4	012090204	1209E/PZ-S4	012091204
1209PZK 0	012099000	1209E PZ/K0	012099200
1209PZK 1	012099003	1209E PZ/K1	012099203
1209PZK 2	012099006	1209E PZ/K2	012099206
1209PZK 3	012099009	1209E PZ/K3	012099209
1209PZK 4	012099012	1209E PZ/K4	012099212
1209N/PZK 1	012099103	1209EN-PZ/K1	012099303
1209N/PZK 2	012099106	1209EN-PZ/K2	012099306
1367/S6	013670100	1367/K10	013670200
1367 17	013670117		
1367 18	013670118		
1367 19	013670119		
1367 20	013670120		
1367 21	013670121		
1367 22	013670122		
1367 23	013670123		
1367 24	013670124		
1367 27	013670127		
1367 28	013670128		
1438K/DSG	014380250		
1467LF	014670100	1467LF/2	014670099
1482A/2	014820006		
1482A/4	014820014		
1485MTJ/1.3	014850160		
1493 96-L9	014930070		
1498CM/12	014980030		
1533/5	015330005	1533/5A	015330006
1534/5	015340005	1534/5A	015340006
1535/C5	015350005	1535/C5A	015350006
1548/C8	015480800		
1604	016040001		
1604/C9	016040045		
1605	016050001		
1606	016060001	1606/2	016060002
1778W	017780025		
1834L/USB	018340075	1833 L/USB	018330054
1834PS	018340310	1833 S	018330002
1834PM	018340320	1833 M	018330003
1834PL	018340325	1833 L	018330004
1834PXL	018340330	1833 XL	018330005
1834RB-L/USB	018340975		
1835/1	018350030	1833 XS/1	018330000
1835/2	018350060	1833 XS/2	018330001
1837N	018370002	1837F	018370050
1837PLUS	018370026	1837C/4300	018370430

1837/USB	018370051	1837F/USB	018370060
1837/USB RB	018370901		
1838SN	018380132	1838S	018380122
1838SLR	018380201	1838SLIM	018380221
1839/R3	018390503		
1916R 6	019160106		
1916R 8	019160108		
1916R 11	019160111		
1918 8	019180008	1918 1/4X8	019180118
1918 10	019180010	1918 3/8X10	019180130
1918 12	019180012	1918 1/2X12	019180142
1972/18	019720018		
1982/12EF	019820012		
2001/B26	020010060	2001/B26	020010215
2009ID	020090013	2009ID	020091013
2028EL/A	020280014	2028EL/A	020281014
2028ET/A	020280018	2028ET/A	020281018
2029EL/B	020290017	2029EL/B	020291017
2029ET/B	020290021	2029ET/B	020291021
2029 BG MQ	020290257	2029 BG MQ	020291257
2032TEL/A	020320314	2032TEL/A	020321314
2032TET/A	020320328	2032TET/A	020321328
2033PEL/A	020330214	2033PEL/A	020331214
2033PEL/B	020330215	2033PEL/B	020331215
2033PET/B	020330227	2033PET/B	020331227
2036EL/B	020360218	2036EL/B	020361218
2036TET/B	020360223	2036TET/B	020361223
2041UC	020410210	2041UC	020410215
2051N	020510210	2051N	020510215
2104VU/0	021040122	2104VU/0	021041122
2055HB	020550220	2055HB	020550215
2105VU/0	021050122	2105VU/0	021051122
2106T/VU0	021060123	2106T/VU0	021061123
2107VU/2	021070112	2107VU/2	021071112
2107VU/3	021070114	2107VU/3	021071114
2108VU/1	021080022	2108VU/1	021081022
2109VU/1	021090022	2109VU/1	021091022
2109VU/3	021090024	2109VU/3	021091024
2110VU/1	021100031	2110VU/1	021101031
2110VU/3	021100034	2110VU/3	021101034
2110VU/AS	021100036	2110VU/AS	021101036
2110SVU/1	021100041	2110SVU/1	021101041
2110SVU/3	021100044	2110SVU/3	021101044
2111VU/1	021110031	2111VU/1	021111031
2111VU/3	021110034	2111VU/3	021111034
2112ET/A	021120028	2112ET/A	021121028
2112ET/B	021120029	2112ET/B	021121029
2112VU/5	021120056	2112VU/5	021121056
2114VU/M	021140011	2114VU/M	021141011
2115PVU/1	021150232	2115PVU/1	021151232
2115PVU/2	021150234	2115PVU/2	021151234
2115PL-VU/1	021150242	2115PL-VU/1	021151242
2115PL-VU/3	021150245	2115PL-VU/3	021151245
2116VU/1	021160102	2116VU/1	021161102
2116VU/3	021160105	2116VU/3	021161105
2117P-VU/1	021170042	2117P-VU/1	021171042
2117P-VU/3	021170045	2117P-VU/3	021171045
2117L-VU/1	021170142	2117L-VU/1	021171142
2117PL-VU/3	021170145	2117PL-VU/3	021171145
2118VU/1	021180032	2118VU/1	021181032
2119VU/3	021190025	2119VU/3	021191025
2119L-VU/3	021190125	2119L-VU/3	021191125
2120VU/2	021200061	2120VU/2	021201061
2120VU/3	021200063	2120VU/3	021201063
2120VU/4	021200064	2120VU/4	021201064
2120VU/AS	021200068	2120VU/AS	021201068
2120L-VU/2	021200161	2120L-VU/2	021201161
2120L-VU/3	021200163	2120L-VU/3	021201163
2120L-VU/4	021200164	2120L-VU/4	021201164
2120L-VU/AS	021200168	2120L-VU/AS	021201168
2254SV	022540100	2254K	022540101
T10	024240010	T01	024240001
T15	024240015	T05	024240005
T16	024240016	T06	024240006
T131	024240131	T137	024240137
T132	024240132	T138	024240138
T142	024240142	T144	024240144
T154	024240154	T156	024240156
T155	024240155	T157	024240157

T210	024240210	T211	024240211
T212	024240212	T213	024240213
T215	024240215	T216	024240216
T220	024240220	T221	024240221
M10	024500010	M01	024500001
M15	024500015	M05	024500005
M16	024500016	M06	024500006
M130	024500130	M129	024500129
M131	024500131	M136	024500136
M132	024500132	M137	024500137
M210	024500210	M213	024500213
M211	024500211	M214	024500214
M212	024500212	M216	024500216
M215	024500215	M217	024500217
M220	024500220	M218	024500218
M221	024500221	M219	024500219
M25	024500873	M25	024500025
M165	024500874	M166	024500879
MB11	024504211	MB12	024504212
MB34	024504234	MB37	024504237
MB35	024504235	MB38	024504238
MB36	024504236	MB39	024504239
MB57	024504257		
MB61	024504261	MB65	024504265
MM10	024580010	MM11	024580011
MM140	024580140	MM140	024580141
MM210	024580210	MM210	024580211
MC10	027500010	MC10	027500011
MC11	041500011	MC12	041500012
C42S	042000001	C42H	042000002
C55LMP/1	055000320		
C55LMP/2	055000322		
5902MT	059020053	5902MT	059021053
5902MT/AS	059020054	5902MT/AS	059021054
5902VI	059020060	5902VI	059021060
5904VG/3	059040062	5904VG/3	059041062
5904VU/2T	059040070	5904VU/2T	059041070
5904VI/1T	059040161	5904VI/1T	059041161
5904VI/2T	059040164	5904VI/2T	059041164
5904VI/3T	059040168	5904VI/3T	059041168
5904VG/2T	059040191	5904VG/2T	059041191
5904VG/5T	059040196	5904VG/5T	059041196
5904VG/1M	059040197	5904VG/2M	059041198
5904VG/2M	059040198	5904VU/1M	059041201
5904VU/1M	059040201	5904VU/2M	059041202
5904VU/2M	059040202	5904VU/3T	059041203
5904VU/3T	059040203	5904VG/3T	059041510
5904VG/3T	059040510		
5905VG/2	059050044	5905VG/2	059051044
5905VG/1	059050058	5905VG/1	059051058
5908VG/2T	059080017	5908VG/2T	059081017
5908VI/2T	059080105	5908VI/2T	059081105
5910VI/3	059100044	5910VI/3	059101044
5910VI/3T	059100063	5910VI/3T	059101063
5910VG/3T	059100068	5910VG/3T	059101068
5914VU/M	059140111	5914VU/M	059140112
5915VU/0	059150021	5915VU/0	059151021
5915VU/1	059150024	5915VU/1	059151024
5915VU/2	059150027	5915VU/2	059151027
5915VU/3	059150028	5915VU/3	059151028
5915VU/AS	059150032	5915VU/AS	059151032
5915VU/4	059150045	5915VU/4	059151045
5915VU/5	059150046	5915VU/5	059151046
5927VU/M	059270021	5927VU/M	059271021
5935VU/1MB	059350301		
5935VI/1MB	059350311		
5935VI/2MB	059350316	5935VI/2MB	059351316
5935VG/1MB	059350321	5935VG/1MB	059351321
5935ET/1MB	059350332	5935ET/1MB	059351332
5938U/2T	059380062	5938U/2T	059381062
5940SBK	059400082	5940SBK	059401082
5941VU/M	059410002	5941VU/M	059411002
5941KART	05		

ELIMINATED ITEMS - SUBSTITUTE/RECOMMENDED ITEMS

	ELIMINATED ITEM
	SUBSTITUTE ITEM
	RECOMMENDED ITEM

5958U	059580008	5958U	059581008
5980U/BIKE	059800040	5980U/BIKE	059801040
5980EL/A	059800081	5980EL/A	059801081
5980EL/B	059800082	5980EL/B	059801082
5980ET/A	059800083	5980ET/A	059801083
5980ET/B	059800084	5980ET/B	059801084
5980ID	059800085	5980ID	059801085
5980MQ	059800257	5980MQ	059801257
5988ROAD/7M	059880087	5988H/7M	059881087
5988U6/M	059880430	5988U6/M	059881430
6600 M/11	066000011		
6600 M/216	066000216		
6600 M/221	066000221		
6600 M/244	066000244		
6600 M/370	066000370		
6600 M/422	066000422		
6600 M/608	066000608		
6600 M/851	066000851		
6600 M/858	066000858		
6600 M/859	066000859		
6600 E/A20	066000913		
6600 E/A30	066000924		
6600 E/C10	066000928		
6600 E/B10	066000971		
6600 E/B20	066000972		
6600 E/A10	066000973		
6600 E/K20	066000982		
7210PB 35	072100435	7224PEK 35	072240235
7210PB 36	072100436	7224PEK 36	072240236
7210PB 37	072100437	7224PEK 37	072240237
7210PB 38	072100438	7224PEK 38	072240238
7210PB 39	072100439	7224PEK 39	072240239
7210PB 40	072100440	7224PEK 40	072240240
7210PB 41	072100441	7224PEK 41	072240241
7210PB 42	072100442	7224PEK 42	072240242
7210PB 43	072100443	7224PEK 43	072240243
7210PB 44	072100444	7224PEK 44	072240244
7210PB 45	072100445	7224PEK 45	072240245
7210PB 46	072100446	7224PEK 46	072240246
7210PB 47	072100447	7224PEK 47	072240247
7210PB 48	072100448	7224PEK 48	072240248
7211PG 35	072110435	7317NA 35	073170135
7211PG 36	072110436	7317NA 36	073170136
7211PG 37	072110437	7317NA 37	073170137
7211PG 38	072110438	7317NA 38	073170138
7211PG 39	072110439	7317NA 39	073170139
7211PG 40	072110440	7317NA 40	073170140
7211PG 41	072110441	7317NA 41	073170141
7211PG 42	072110442	7317NA 42	073170142
7211PG 43	072110443	7317NA 43	073170143
7211PG 44	072110444	7317NA 44	073170144
7211PG 45	072110445	7317NA 45	073170145
7211PG 46	072110446	7317NA 46	073170146
7211PG 47	072110447	7317NA 47	073170147
7211PG 48	072110448	7317NA 48	073170148
7237WR 35	072370235	7238WR 35	072380235
7237WR 36	072370236	7238WR 36	072380236
7237WR 37	072370237	7238WR 37	072380237
7237WR 38	072370238	7238WR 38	072380238
7237WR 39	072370239	7238WR 39	072380239
7237WR 40	072370240	7238WR 40	072380240
7237WR 41	072370241	7238WR 41	072380241
7237WR 42	072370242	7238WR 42	072380242
7237WR 43	072370243	7238WR 43	072380243
7237WR 44	072370244	7238WR 44	072380244
7237WR 45	072370245	7238WR 45	072380245
7237WR 46	072370246	7238WR 46	072380246
7237WR 47	072370247	7238WR 47	072380247
7237WR 48	072370248	7238WR 48	072380248
7239C 35	072390235		
7239C 36	072390236		
7239C 37	072390237		
7239C 38	072390238		

7239C 39	072390239		
7239C 40	072390240		
7239C 41	072390241		
7239C 42	072390242		
7239C 43	072390243		
7239C 44	072390244		
7239C 45	072390245		
7239C 46	072390246		
7239C 47	072390247		
7239C 48	072390248		
7241FT 35	072410635	7243FT 35	072430635
7241FT 36	072410636	7243FT 36	072430636
7241FT 37	072410637	7243FT 37	072430637
7241FT 38	072410638	7243FT 38	072430638
7241FT 39	072410639	7243FT 39	072430639
7241FT 40	072410640	7243FT 40	072430640
7241FT 41	072410641	7243FT 41	072430641
7241FT 42	072410642	7243FT 42	072430642
7241FT 43	072410643	7243FT 43	072430643
7241FT 44	072410644	7243FT 44	072430644
7241FT 45	072410645	7243FT 45	072430645
7241FT 46	072410646	7243FT 46	072430646
7241FT 47	072410647	7243FT 47	072430647
7241FT 48	072410648	7243FT 48	072430648
7290NA 36	072900336		
7290NA 37	072900337		
7290NA 38	072900338		
7290NA 39	072900339		
7290NA 40	072900340		
7290NA 41	072900341		
7290NA 42	072900342		
7290NA 43	072900343		
7290NA 44	072900344		
7290NA 45	072900345		
7290NA 46	072900346		
7290NA 47	072900347		
7290NA 48	072900348		
7291NA 36	072910336		
7291NA 37	072910337		
7291NA 38	072910338		
7291NA 39	072910339		
7291NA 40	072910340		
7291NA 41	072910341		
7291NA 42	072910342		
7291NA 43	072910343		
7291NA 44	072910344		
7291NA 45	072910345		
7291NA 46	072910346		
7291NA 47	072910347		
7291NA 48	072910348		
7313G 35	073130635	7314AF 35	073140235
7313G 36	073130636	7314AF 36	073140236
7313G 37	073130637	7314AF 37	073140237
7313G 38	073130638	7314AF 38	073140238
7313G 39	073130639	7314AF 39	073140239
7313G 40	073130640	7314AF 40	073140240
7313G 41	073130641	7314AF 41	073140241
7313G 42	073130642	7314AF 42	073140242
7313G 43	073130643	7314AF 43	073140243
7313G 44	073130644	7314AF 44	073140244
7313G 45	073130645	7314AF 45	073140245
7313G 46	073130646	7314AF 46	073140246
7313G 47	073130647	7314AF 47	073140247
7313G 48	073130648	7314AF 48	073140248
7313B 35	073130835	7314AB 35	073140335
7313B 36	073130836	7314AB 36	073140336
7313B 37	073130837	7314AB 37	073140337
7313B 38	073130838	7314AB 38	073140338
7313B 39	073130839	7314AB 39	073140339
7313B 40	073130840	7314AB 40	073140340
7313B 41	073130841	7314AB 41	073140341
7313B 42	073130842	7314AB 42	073140342
7313B 43	073130843	7314AB 43	073140343
7313B 44	073130844	7314AB 44	073140344
7313B 45	073130845	7314AB 45	073140345
7313B 46	073130846	7314AB 46	073140346
7313B 47	073130847	7314AB 47	073140347
7313B 48	073130848	7314AB 48	073140348
7316N 35	073160535	7315AN 35	073150535

7316N 36	073160536	7315AN 36	073150536
7316N 37	073160537	7315AN 37	073150537
7316N 38	073160538	7315AN 38	073150538
7316N 39	073160539	7315AN 39	073150539
7316N 40	073160540	7315AN 40	073150540
7316N 41	073160541	7315AN 41	073150541
7316N 42	073160542	7315AN 42	073150542
7316N 43	073160543	7315AN 43	073150543
7316N 44	073160544	7315AN 44	073150544
7316N 45	073160545	7315AN 45	073150545
7316N 46	073160546	7315AN 46	073150546
7316N 47	073160547	7315AN 47	073150547
7316N 48	073160548	7315AN 48	073150548
7526 XS	075260046	7528 XS	075280046
7526 S	075260048	7528 S	075280048
7526 M	075260050	7528 M	075280050
7526 L	075260052	7528 L	075280052
7526 XL	075260054	7528 XL	075280054
7526 XXL	075260056	7528 XXL	075280056
7526 XXXL	075260058	7528 XXXL	075280058
7546BL XS	075460000	7547BL XS	075470200
7546BL S	075460001	7547BL S	075470201
7546BL M	075460002	7547BL M	075470202
7546BL L	075460003	7547BL L	075470203
7546BL XL	075460004	7547BL XL	075470204
7546BL XXL	075460005	7547BL XXL	075470205
7546BL XXXL	075460006	7547BL XXXL	075470206
7546G XS	075460100	7547G XS	075470300
7546G S	075460101	7547G S	075470301
7546G M	075460102	7547G M	075470302
7546G L	075460103	7547G L	075470303
7546G XL	075460104	7547G XL	075470304
7546G XXL	075460105	7547G XXL	075470305
7546G XXXL	075460106	7547G XXXL	075470306
7546N XS	075460200	7547N XS	075470400
7546N S	075460201	7547N S	075470401
7546N M	075460202	7547N M	075470402
7546N L	075460203	7547N L	075470403
7546N XL	075460204	7547N XL	075470404
7546N XXL	075460205	7547N XXL	075470405
7546N XXXL	075460206	7547N XXXL	075470406
7548BL XS	075480000	7549BL XS	075490200
7548BL S	075480001	7549BL S	075490201
7548BL M	075480002	7549BL M	075490202
7548BL L	075480003	7549BL L	075490203
7548BL XL	075480004	7549BL XL	075490204
7548BL XXL	075480005	7549BL XXL	075490205
7548BL XXXL	075480006	7549BL XXXL	075490206
7548G XS	075480100	7549G XS	075490300
7548G S	075480101	7549G S	075490301
7548G M	075480102	7549G M	075490302
7548G L	075480103	7549G L	075490303
7548G XL	075480104	7549G XL	075490304
7548G XXL	075480105	7549G XXL	075490305
7548G XXXL	075480106	7549G XXXL	075490306
7548N XS	075480200	7549N XS	075490400
7548N S	075480201	7549N S	075490401
7548N M	075480202	7549N M	075490402
7548N L	075480203	7549N L	075490403
7548N XL	075480204	7549N XL	075490404
7548N XXL	075480205	7549N XXL	075490405
7548N XXXL	075480206	7549N XXXL	075490406
7622G XS	076220000	7657N XS	076570000
7622G S	076220001	7657N S	076570001
7622G M	076220002	7657N M	076570002
7622G L	076220003	7657N L	076570003
7622G XL	076220004	7657N XL	076570004
7622G XXL	076220005	7657N XXL	076570005
7622G XXXL	076220006	7657N XXXL	076570006
7632G XS	076320000	7657N XS	076570000
7632G S	076320001	7657N S	076570001
7632G M	076320002	7657N M	076570002
7632G L	076320003	7657N L	076570003
7632G XL	076320004	7657N XL	076570004
7632G XXL	076320005	7657N XXL	076570005
7632G XXXL	076320006	7657N XXXL</	

ELIMINATED ITEMS - SUBSTITUTE/RECOMMENDED ITEMS

	ELIMINATED ITEM
	SUBSTITUTE ITEM
	RECOMMENDED ITEM

7635G L	076350513	7635N L	076350503
7635G XL	076350514	7635N XL	076350504
7635G XXL	076350515	7635N XXL	076350505
7635G XXXL	076350516	7635N XXXL	076350506
7636BL XS	076360000	7654N XS	076540000
7636BL S	076360001	7654N S	076540001
7636BL M	076360002	7654N M	076540002
7636BL L	076360003	7654N L	076540003
7636BL XL	076360004	7654N XL	076540004
7636BL XXL	076360005	7654N XXL	076540005
7636BL XXXL	076360006	7654N XXXL	076540006
7683 S	076830001	7659N S	076590001
7683 M	076830002	7659N M	076590002
7683 L	076830003	7659N L	076590003
7683 XL	076830004	7659N XL	076590004
7683 XXL	076830005	7659N XXL	076590005
7683 XXXL	076830006	7659N XXXL	076590006
7684 S	076840001	7658N S	076580001
7684 M	076840002	7658N M	076580002
7684 L	076840003	7658N L	076580003
7684 XL	076840004	7658N XL	076580004
7684 XXL	076840005	7658N XXL	076580005
7684 XXXL	076840006	7658N XXXL	076580006
7685 S	076850001		
7685 M	076850002		
7685 L	076850003		
7685 XL	076850004		
7685 XXL	076850005		
7860E XS	078600900	7860G XS	078600800
7860E S	078600901	7860G S	078600801
7860E M	078600902	7860G M	078600802
7860E L	078600903	7860G L	078600803
7860E XL	078600904	7860G XL	078600804
7860E XXL	078600905	7860G XXL	078600805
7860E XXXL	078600906	7860G XXXL	078600806
7860E XXXXL	078600907	7860G XXXXL	078600807
7861E XS	078610900	7861G XS	078610800
7861E S	078610901	7861G S	078610801
7861E M	078610902	7861G M	078610802
7861E L	078610903	7861G L	078610803
7861E XL	078610904	7861G XL	078610804
7861E XXL	078610905	7861G XXL	078610805
7861E XXXL	078610906	7861G XXXL	078610806
7861E XXXXL	078610907	7861G XXXXL	078610807
7863E XS	078630900	7863G XS	078630800
7863E S	078630901	7863G S	078630801
7863E M	078630902	7863G M	078630802
7863E L	078630903	7863G L	078630803
7863E XL	078630904	7863G XL	078630804
7863E XXL	078630905	7863G XXL	078630805
7863E XXXL	078630906	7863G XXXL	078630806
7863E XXXXL	078630907	7863G XXXXL	078630807
7865E XS	078650900	7865G XS	078650800
7865E S	078650901	7865G S	078650801
7865E M	078650902	7865G M	078650802
7865E L	078650903	7865G L	078650803
7865E XL	078650904	7865G XL	078650804
7865E XXL	078650905	7865G XXL	078650805
7865E XXXL	078650906	7865G XXXL	078650806
7865E XXXXL	078650907	7865G XXXXL	078650807
7867E XS	078670900		
7867E S	078670901		
7867E M	078670902		
7867E L	078670903		
7867E XL	078670904		
7867E XXL	078670905		
7867E XXXL	078670906		
7867E XXXXL	078670907		
7869E XS	078690900	7869G XS	078690800
7869E S	078690901	7869G S	078690801
7869E M	078690902	7869G M	078690802
7869E L	078690903	7869G L	078690803
7869E XL	078690904	7869G XL	078690804

7869E XXL	078690905	7869G XXL	078690805
7869E XXXL	078690906	7869G XXXL	078690806
7869E XXXXL	078690907	7869G XXXXL	078690807
7870E XS	078700900	7860G XS	078600800
7870E S	078700901	7860G S	078600801
7870E M	078700902	7860G M	078600802
7870E L	078700903	7860G L	078600803
7870E XL	078700904	7860G XL	078600804
7870E XXL	078700905	7860G XXL	078600805
7870E XXXL	078700906	7860G XXXL	078600806
7870E XXXXL	078700907	7860G XXXXL	078600807
7871E XS	078710900	7861G XS	078610800
7871E S	078710901	7861G S	078610801
7871E M	078710902	7861G M	078610802
7871E L	078710903	7861G L	078610803
7871E XL	078710904	7861G XL	078610804
7871E XXL	078710905	7861G XXL	078610805
7871E XXXL	078710906	7861G XXXL	078610806
7871E XXXXL	078710907	7861G XXXXL	078610807
7873E XS	078730900	7863G XS	078630800
7873E S	078730901	7863G S	078630801
7873E M	078730902	7863G M	078630802
7873E L	078730903	7863G L	078630803
7873E XL	078730904	7863G XL	078630804
7873E XXL	078730905	7863G XXL	078630805
7873E XXXL	078730906	7863G XXXL	078630806
7873E XXXXL	078730907	7863G XXXXL	078630807
7875E XS	078750900	7865G XS	078650800
7875E S	078750901	7865G S	078650801
7875E M	078750902	7865G M	078650802
7875E L	078750903	7865G L	078650803
7875E XL	078750904	7865G XL	078650804
7875E XXL	078750905	7865G XXL	078650805
7875E XXXL	078750906	7865G XXXL	078650806
7875E XXXXL	078750907	7865G XXXXL	078650807
7877E XS	078770900	7867G XS	078670800
7877E S	078770901	7867G S	078670801
7877E M	078770902	7867G M	078670802
7877E L	078770903	7867G L	078670803
7877E XL	078770904	7867G XL	078670804
7877E XXL	078770905	7867G XXL	078670805
7877E XXXL	078770906	7867G XXXL	078670806
7877E XXXXL	078770907	7867G XXXXL	078670807
7879E XS	078790900	7869G XS	078690800
7879E S	078790901	7869G S	078690801
7879E M	078790902	7869G M	078690802
7879E L	078790903	7869G L	078690803
7879E XL	078790904	7869G XL	078690804
7879E XXL	078790905	7869G XXL	078690805
7879E XXXL	078790906	7869G XXXL	078690806
7879E XXXXL	078790907	7869G XXXXL	078690807
7900E XS	079000900	7900G XS	079000800
7900E S	079000901	7900G S	079000801
7900E M	079000902	7900G M	079000802
7900E L	079000903	7900G L	079000803
7900E XL	079000904	7900G XL	079000804
7900E XXL	079000905	7900G XXL	079000805
7900E XXXL	079000906	7900G XXXL	079000806
7900E XXXXL	079000907	7900G XXXXL	079000807
7901E XS	079010900	7901G XS	079010800
7901E S	079010901	7901G S	079010801
7901E M	079010902	7901G M	079010802
7901E L	079010903	7901G L	079010803
7901E XL	079010904	7901G XL	079010804
7901E XXL	079010905	7901G XXL	079010805
7901E XXXL	079010906	7901G XXXL	079010806
7901E XXXXL	079010907	7901G XXXXL	079010807
7903E XS	079030900	7903G XS	079030800
7903E S	079030901	7903G S	079030801
7903E M	079030902	7903G M	079030802
7903E L	079030903	7903G L	079030803
7903E XL	079030904	7903G XL	079030804
7903E XXL	079030905	7903G XXL	079030805
7903E XXXL	079030906	7903G XXXL	079030806
7903E XXXXL	079030907	7903G XXXXL	079030807
7904E XS	079040900	7904N XS	079040800
7904E S	079040901	7904N S	079040801
7904E M	079040902	7904N M	079040802
7904E L	079040903	7904N L	079040803

7904E XL	079040904	7904N XL	079040804
7904E XXL	079040905	7904N XXL	079040805
7904E XXXL	079040906	7904N XXXL	079040806
7904E XXXXL	079040907	7904N XXXXL	079040807
7905E XS	079050900	7905G XS	079050800
7905E S	079050901	7905G S	079050801
7905E M	079050902	7905G M	079050802
7905E L	079050903	7905G L	079050803
7905E XL	079050904	7905G XL	079050804
7905E XXL	079050905	7905G XXL	079050805
7905E XXXL	079050906	7905G XXXL	079050806
7905E XXXXL	079050907	7905G XXXXL	079050807
7907E XS	079070900	7907G XS	079070800
7907E S	079070901	7907G S	079070801
7907E M	079070902	7907G M	079070802
7907E L	079070903	7907G L	079070803
7907E XL	079070904	7907G XL	079070804
7907E XXL	079070905	7907G XXL	079070805
7907E XXXL	079070906	7907G XXXL	079070806
7907E XXXXL	079070907	7907G XXXXL	079070807
7909E XS	079090900	7909G XS	079090800
7909E S	079090901	7909G S	079090801
7909E M	079090902	7909G M	079090802
7909E L	079090903	7909G L	079090803
7909E XL	079090904	7909G XL	079090804
7909E XXL	079090905	7909G XXL	079090805
7909E XXXL	079090906	7909G XXXL	079090806
7909E XXXXL	079090907	7909G XXXXL	079090807
8061F 5,3	080610153	8061R 5,3	080610253
8085 1,5	080850016	8085 1500	080850215
8085 2,0	080850020	8085 2000	080850220
8085 3,15	080850032	8085 3150	080850232
8085 5,3	080850054	8085 5300	080850253
9507D S	095070061	9501TLD S	095010061
9507D M	095070062	9501TLD M	095010062
9507D L	095070063	9501TLD L	095010063
9507D XL	095070064	9501TLD XL	095010064
9537N M	095370102	9537TL M	095370052
9537N L	095370103	9537TL L	095370053
9537N XL	095370104	9537TL XL	095370054
9537N XXL	095370105	9537TL XXL	095370055
9549PB	095490051	9549BP	095490052
9549USB	095490061	9549C	095490062
9563P	095630010	9563U	095630020
11001 115X2,5	110010117	11001 115X3,2	110010118
11001 125X2,5	110010127	11001 125X3,2	110010128
11001 230X2,5	110010232	11001 230X3,2	110010233
11021 115X2,5	110210117	11021 115X3,2	110210118
11021 125X2,5	110210127	11021 125X3,2	110210128
11021 180X2,5	110210182	11021 180X3,2	110210183
11021 230X2,5	110210232	11021 230X3,2	110210233
11024 180X2,0	110240180	11037 2,0-22,23	110370022
11050S 230X7	110500430	11050 230X7	110500230
11100 5X10	111000005	11100 6X10	111000006
11100 6X13	111000007	11100 8X12	111000008
11101 3X6	111010003	11101 4X8	111010004
11232B 40	112320104	11230B 40	112300104
11232B 60	112320106	11230B 60	112300106
11246B 40	112460104	11248B 40	112480104
11246B 60	112460106	11248B 60	112480106
11310A 60	113100006	11300A 60	113000006
11310A 80	113100008	11300A 80	113000008
11310B 60	113100106	11300B 60	113000106
11310B 80	113100108	11300B 80	113000108
11310C 60	113100206	11300C 60	113000206
11310C 80	113100208	11300C 80	113000208
11310D 60	11310		

Abrasive discs	505÷507, 518
Abrasive shaft-mounted wheels	508÷511
Adjustable wrenches	36, 263, 277, 283
Amperometric clamps	222
Anti-waste rolls	519
Assortments of tools in thermoformed trays	410÷495
Auto-darkening LCD mask	235
Automatic cable reels with inspection lamps	233
Automatic hose reel for compressed air or cold water	233
Barrel pumps	238
Battery tools	289
Beta Abrasives	503÷519
Beta Chemicals	498÷502
Beta Collection	629÷639
BetaEVOX screwdrivers	139÷141
BetaGrip screwdrivers	144÷148, 266-267
Betamax screwdrivers	148÷150, 278, 286
Bevel gearbox	86
Bevel protractor	205
Bicycle tools	257÷260
Bit reamers	210
Bits and bit holders	36, 39, 79÷86, 143, 263
Bits for drilling, threading and countersinking	57
Blister pack range	526÷539
Blocks and hoists	611
Bolt cutters	130
Bonding guns	217
Bottle holders	337
Bristle brush	215
Brushes	215, 288
Cable cutters	133
Cable cutters for steel cables	133
Cable stripping tools and wire stripping pliers	134
Callipers	205
Cape chisels	24
Carpenter's pencil	206
Centre punches	23
Chalk line reels and powder	209
Circlip pliers	124-125, 285-286
Closed end terminals	522
Combination pliers	135, 265, 277, 286
Combination wrenches	24÷26, 37-38, 276, 281
Combo tool cases and accessories	322÷324
Covers for tool chests	355, 362
Crimping pliers for terminals and terminals	199÷201,
Crowfoot wrenches, 3/8" square drive	96
Cutting nippers for electronic purposes	138-139
Desoldering pumps	229
Detergents	502
Diagonal and end cutting nippers	128-129, 138-139, 265, 277, 286
Dial indicators	203
Dies and assortments	57÷60



Digital litre counter for oil	238
Digital tachometer	223
Display units for sales points	540÷552
Double ended hexagon / bi-hex offset socket wrenches	110-111, 285
Double swivel end socket wrenches	28
Double-ended offset ring wrench for scaffolding bolts	29-30, 282
Drift punches	23, 281
Electrician's scissors	132-133, 265
Electronic torque meter with Dynatester transducer	65, 72
Electronic videoscope	119
Engineer's scribes	206
Extractors for damaged screws and studs	160-161
Extra-flat chisels with straight cutters	122, 152
Files	152, 211÷214, 288
Filtering mask	590
Fitting tool for ties and ties	217, 525
Fixed frame hacksaw	214
Flap discs	511÷515
Flap/non-woven wheels	517-518
Flare nut open ring wrenches	30, 36, 38
Flat chisels	23, 281
Flexible magnetic pickup tools	209-210
Flexible pickup tools	210
Fluid extractor	238
Folding tool trolley	323
Friction tape	525
Graduated rules	205
Hacksaw frames and blades	214-288
Hammers	152-153, 156÷159, 278, 287
Hand crimper steel matrix	128
Hand punch steel punch and matrix	128
Hand sockets, accessories and assortments, 1/4"	86÷92
Hand sockets, accessories and assortments, 3/8"	87÷98, 263-264, 283-284
Hand sockets, accessories and assortments, 1/2"	98÷107, 264, 277, 284-285
Hand sockets, accessories and assortments, 3/4"	107÷109, 284-285
Hand sockets, accessories and assortments, 1"	109
Hand taps and assortments	53÷55, 59-60
Heat guns	233
Heating plates for manual straight and slanted welding of plastic pipes	39
Heavy-duty cable cutters	130
Hi-torque hexagon nut spinners with handles	112, 265
Holesaws and hole cutters and accessories	60÷62
Hook wrenches	36, 283
Hot glue guns	233
Hub and wheel drum pullers	192-193
Hydraulic press	198
Hydraulic pullers	185
Impact screwdrivers	149-150
Impact sockets, accessories and assortments	73÷79
Industrial tool chests	345-346
Inspection mirrors	210
Instant glue	501
Insulated tools, 1000V	261÷267

Abrasive discs	505÷507, 518
Abrasive shaft-mounted wheels	508÷511
Adjustable wrenches	36, 263, 277, 283
Amperometric clamps	222
Anti-waste rolls	519
Assortments of tools in thermoformed trays	410÷495
Auto-darkening LCD mask	235
Automatic cable reels with inspection lamps	233
Automatic hose reel for compressed air or cold water	233
Barrel pumps	238
Battery tools	289
Beta Abrasives	503÷519
Beta Chemicals	498÷502
Beta Collection	629÷639
BetaEVOX screwdrivers	139÷141
BetaGrip screwdrivers	144÷148, 266-267
BetamaX screwdrivers	148÷150, 278, 286
Bevel gearbox	86
Bevel protractor	205
Bicycle tools	257÷260
Bit reamers	210
Bits and bit holders	36, 39, 79÷86, 143, 263
Bits for drilling, threading and countersinking	57
Blister pack range	526÷539
Blocks and hoists	611
Bolt cutters	130
Bonding guns	217
Bottle holders	337
Bristle brush	215
Brushes	215, 288
Cable cutters	133
Cable cutters for steel cables	133
Cable stripping tools and wire stripping pliers	134
Callipers	205
Cape chisels	24
Carpenter's pencil	206
Centre punches	23
Chalk line reels and powder	209
Circlip pliers	124-125, 285-286
Closed end terminals	522
Combination pliers	135, 265, 277, 286
Combination wrenches	24÷26, 37-38, 276, 281
Combo tool cases and accessories	322÷324
Covers for tool chests	355, 362
Crimping pliers for terminals and terminals	199÷201,
Crowfoot wrenches, 3/8" square drive	96
Cutting nippers for electronic purposes	138-139
Desoldering pumps	229
Detergents	502
Diagonal and end cutting nippers	128-129, 138-139, 265, 277, 286
Dial indicators	203
Dies and assortments	57÷60



Pliers for electronic purposes	137-138
Plumbing tools	39÷45
Pneumatic tools and accessories	290÷312
Polywelders and forms	39
Portable tool chests	325-326, 351-352
Pre-insulated terminals	521
Protractors	205
Pry bars	120, 209, 285
Pullers	192÷194
Punch press	201-202
Punches	130-131
Radius gauges	209
Ratcheting wrenches	30, 36÷39
Ratchet-type shears for PVC pipes	41
Reversible screwdrivers	147-148
Revolving punch pliers	224
Ring wrenches	28÷30, 263, 282-283
Riveting pliers and rivets	215÷217
Robur wire rope accessories	593÷627
Safety footwear	552÷576
Safety goggles	590
Scissors	133, 228, 288
Scrapers	176, 210-211, 226, 288
Screw clamps	198-199
Screw pitch gauge	209
Screwdrivers with steel heads	142
Screwholding screwdrivers	142
Seat with castors	243-244
Self-locking pliers	126÷128
Shears	131-132
Single and double open end wrenches	26÷28, 263, 281-282
Sledge hammers	158, 287
Slip joint pliers, boxed joints	125-126, 134, 265, 277, 286
Slogging wrenches	27-28, 282
Soft face hammers	159, 287
Soldering irons	228-229
Sparkproof axe	288
Sparkproof pick	288
Sparkproof safety valve wrenches	285
Sparkproof shovel	288
Sparkproof tools	280÷288
Spatulas	214, 278
Special end mills for welding	51
Spirit levels and levelling staffs	207-208
Spray cleaner	502
Spray grease	501
Spray guns	309
Spray silicone	501
Spray unlocking lubricant	501
Spray zinc	502
Spring puller	214
Spring tweezers	122÷124, 265
Squares	204-205



Stainless steel helicoids	55-56
Stainless steel tools	275÷279
Stepped drills	51
Suction lifters	224-225
Support for impact wrenches	295
Tap wrenches and die stocks	55, 58
Tethered tools	268÷274
T-handle socket wrenches for hexagon and Torx® head screws	112÷114
T-handle wrenches with three male ends for hexagon and Torx® head screws	113-114, 265, 285
Thermal camera	224
Thermoformed tool trays	469÷495
Thermometers	223-224
Thread sealant	499
Threadlocker	499
Three-leg pullers	191-192, 198
Tool accessories for cabinets, drawers and panels	495÷497
Tool assortments	410÷495
Tool bags	314÷319
Tool boxes	318÷321
Tool cabinets	366, 395
Tool cabinets, sheet metal	396÷398, 410
Tool cases	314÷317, 322÷324
Tool chest trolleys	325
Tool pouches with belts	314
Tool rucksack	317
Tool trolleys, 2 wheels	315, 318-319, 357÷359
Tool trolleys, 4 wheels	339÷341, 360÷362, 389
Tool trunks	321
Torches	229-230
Torque angle indicators	66
Torque bars	70-71
Torque multipliers	63-64
Torque screwdrivers	65
Torque wrenches and bars	65÷72
Tube flaring tools	42
Tubular socket wrenches	110-111
Twist drills with cylindrical shanks	46÷50
Two-leg pullers	190÷192, 198
Ultrasonic cleaning tank	242
Utility knives	226
Vacuum cleaners for solid and fluid	235-236
Vehicle repair	114÷122, 150÷156, 160÷189, 192÷198, 219÷221, 224-225, 237÷251
Voltage tester	223
Warning and prohibition signs	590
Welding machines	234
Wood rip saw	214
Work mat	254, 371, 399, 639
Workbenches	365, 367÷373, 378÷380
Workshop Equipment	374÷411
Workshop verniers	202-203
Workwear	577÷591
Wrenches for control panel operators	199

Automotive



Acid densimeter, glass body	220
Adjustable body blade holders with flexible flat blades	152
Air conditioner charging station	241
Air hydraulic jack	251
Antifreeze densimeter, glass body	220
Automatic gearbox station	239
Ball joint pullers	197
Battery chargers	187
Battery fillers	219
Battery lug and post cleaner steel brush	215
Bench sander	243
Brake fluid extractor	170
Brake spring pliers	170-171
Car protectors	244
Chain opening tool	256
Claw hammers	152
Clip pliers	224
Clutch aligners	161
Compressors for shock absorber springs	195
Cooling system seal testers	220
Creepers	244-245
Curved angled spoons	151
Dent puller	153
Dent reflector	153
Diesel injector test and calibrating hand pump	119
Digital pressure and compression tester	167
Dollies	150
DSG lever	161
Engine brackets	247
Engine oil-filter wrenches	180
Exhaust pipe expanders	174
Exhausted oil drain units	237
External butt-ended circlip pliers	163
Feeler gauges for car body repair shops	152
Fluid collection tank	237-238
Folding hydraulic crane	247
Four-way hexagon wheel nut wrenches	121
Gas oil filter wrenches	182
Gauge for tyre threads	209
Gearbox/transmission trolley	362
Heavy vehicle tools	121
Heavy vehicle wheel hub nut locking sockets	121

INDEX OF CAR VEHICLE TOOLS



Homokinetic joint pullers	197
Hose clamp pliers	172
Hose pliers	176
Hydraulic bottle jacks	246
Hydraulic car jack with wheels	250
Hydraulic pit and under bridge jack	248
Hydraulic press	249
Impact sockets for axle nuts	120
Impact sockets for wheel nuts	74-75
Instrument for controlling compression on petrol and Diesel engines	117
Jack and positioner for truck wheels	246
Jack stands	246
Kit for filling diesel oil filters	176
Leaf spring pin sockets	196
Lever for removing wishbone heads from pillar	197
Male guide pins for wheel installation	121-122
Mobile workstation for diagnostic tools	360
Motorcycle stands	253
Oil seal wrenches	183
Packing removal tool	193
Parking sensor punches	155
Part cleaning tank	343
Piston ring compressors	162
Plastic funnel	219-220
Pneumatic dent puller	154
Pneumatic valve grinder	162
Quick coupler pliers for fuel pipes	177
Reamers for cleaning injector seats	119
Rubber-covered aluminium foil, formable	220
Signal detector	223
Sliding gauges for brake discs and drums	202
Sockets for Diesel engine injectors	115
Sockets for Lambda probes	116
Sonoscope probe	189
Spark plug pliers	173-174
Spark plug wrenches and sockets	115
Spring pulling hook wrenches	160
Square impact sockets for Isuzu wheel nuts	77
Starters	185-186
Stopping knives made of stainless steel	152
Striking tools for installing conical bearings and oil seals	198
Telescopic rod	225
Temperature sensor wrenches	117
Tester for batteries and recharging systems	189
Timing devices	163
Tool for disc brake pistons	171
Tool for removing and inserting silentblocks	197

INDEX OF CAR VEHICLE TOOLS

	📄
Tools for airbag	161
Tools for air-conditioning systems	177
Tools for common rail diesel injector	117
Tools for pulling out car radios	224
Tools for releasing electrical connectors	185
Tools for removing broken glow plugs	118
Tools for removing glass windows	225
Tools for spark plug coils	173
Tools for tyre valves	122
Torsion bars for wheel nuts	78
Trim pin removers	175
Tyre inflator	308
Tyre levers	119-120
Tyre pressure sensor tool	121
Underbody trolley for vehicles	246
Valve depressors for disc removal	170
Valve seat removing tool	163
Valve spring compressors	162
Valve timing system pulley locking tools	167
Vapour extractor	119
Voltage stabilizer	189
Voltage tester	185
Wheel balancing weight tool	122
Wheel covers	121
Wheel hub nut locking sockets	120-121
Wheel lifter	246
Wheel nut plastic cap pliers	121
Wheeled bodywork spotter	154
Window trim tool remover	225
Wrench for natural gas cylinder valves	179-180
Wrench for removing steering arms	197
Wrench for turbines	174
Wrenches for fuel connectors	166
Wrenches for fuel tank floating ring nuts	176-177

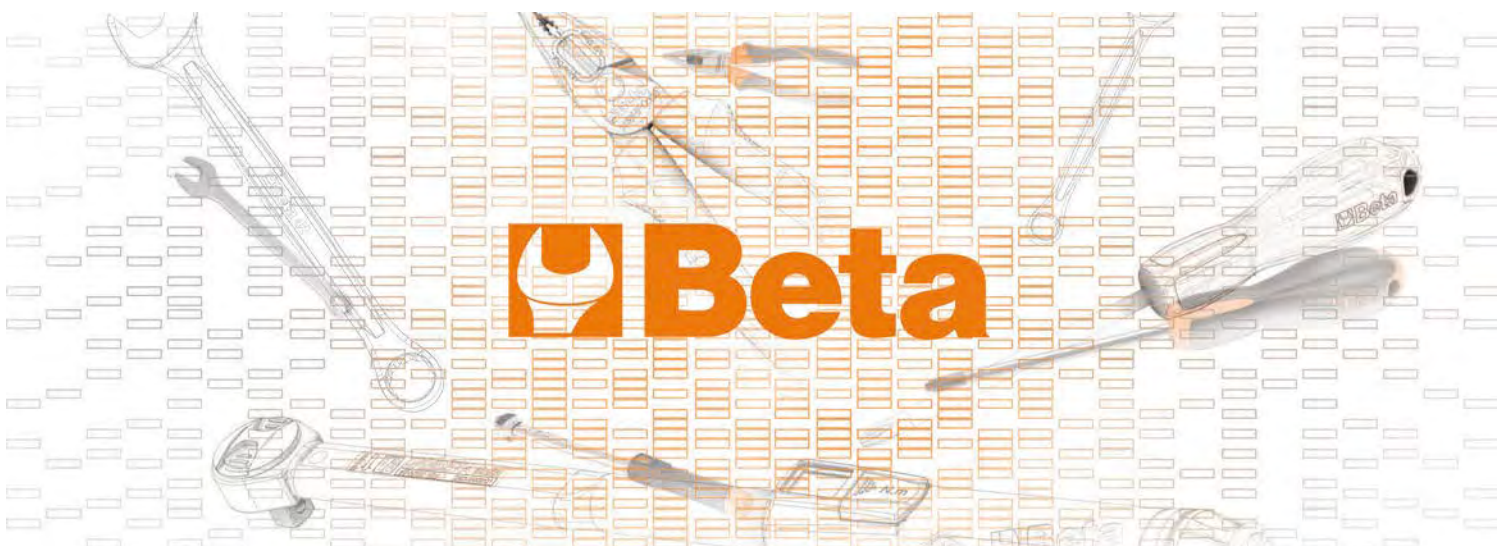

ALPHANUMERIC INDEX

1		1031/S4	124	1067	128	1122K	532	1150HPC	135
		1032	124	1077	128	1123	131	1150INOX	277
		1032BA	285	1078	128	1123K	532	1150K	533
100	36	1032HS	271	1080D	128	1124	131	1150MQ	265
100/KIT	36	1032K	531	1081	128	1124K	532	1153	135
110BA	283	1033	125	1082	128	1125	132	1153INOX	277
110MQ	263	1033K	531	1082BA	286	1126	132	1162	135
111	36	1034	125	1082BM	128	1127	132	1162BA	286
111G	36	1034HS	271	1082BM-HS	271	1128BAX	132	1162BM	135
111HS	270	1034K	531	1082BMK	531	1128BAX-HS	271	1162BMK	533
111INOX	277	1034L	125	1082G	128	1128BCX	132	1162G	135
111K	528	1036	125	1082GBM	129	1128BM	133	1162GBM	135
111N	36	1036BA	286	1082GBMK	531	1128BMX	132	1162GBMK	533
120	36	1036HS	271	1082GK	531	1128BMX/F	132	1162GK	533
120/B	36	1036K	531	1082INOX	277	1128BSX	132	1162K	533
123/K4	37	1037	125	1082K	531	1128FX	132	1162MQ	266
123E1/4	36	1037K	531	1082MQ	265	1128FXS	133	1164	135
123Q1/2	37	1038	125	1084	129	1128MQ	265	1164BM	136
123Q1/4	37	1038HS	271	1084BM	129	1129BM	133	1164BMK	533
123Q3/8	37	1038K	531	1084BMK	532	1129BMK	533	1164K	533
141	37	1039	125	1084G	129	1130BMX	133	1164MQ	266
141/B	37	1044	125	1084GBM	129	1131CK	133	1166	136
141/S	37	1044F	125	1084GBMK	532	1132	133	1166BA	286
142	37	1044FK	531	1084GK	532	1132BM	133	1166BM	136
142/B	37	1044K	531	1084K	531	1132BM-HS	271	1166BM-HS	272
142/S	37	1046	125	1084MQ	265	1132BMK	533	1166BMK	534
142/SC9I-E	37	1046BA	286	1088	129	1132K	533	1166G	136
142AS	38	1046K	531	1088BM	129	1132MQ	265	1166GBM	136
142AS/S	38	1047	125	1088BM-HS	271	1133	133	1166GBMK	534
142C	38	1047BM	126	1088BMK	532	1133RL	133	1166GK	534
142C/A	38	1048	126	1088K	532	1134	133	1166K	534
142HS	270	1048BM	126	1088MQ	265	1134A	133	1166MQ	266
142K	528	1048BM-HS	271	1092V	129	1134A/RL	133	1168	136
142MC	38	1048INOX	277	1094V	129	1134RL	133	1168BM	136
142MC/SC9I-E	38	1048K	531	1095N	129	1136	133	1168BM-HS	272
142SN	38	1048MQ	265	1096	129	1137BA	286	1168BMK	534
142SN/S	38	1048V	126	1096K	532	1137BA/RC	286	1168G	136
186	38	1048VK	531	1098	130	1142BM	134	1168GBM	136
187	38	1050	126	1098K	532	1142BMK	533	1168GBMK	534
187/B5	38	1051	126	1098PL	130	1142MQ	265	1168GK	534
188	38	1051GM	126	1098PLK	532	1143	134	1168K	534
192	38	1051L	126	1100BA 600	286	1143R	134	1168MQ	266
192/S2	39	1051XL	126	1101	130	1144D	134	1169/D3	136
194	39	1052	126	1101R	130	1144D/RG	134	1169BM/D3	137
195	39	1052BA	286	1102	130	1144D/RL	134	1169G/D3	136
195/B5	39	1052HS	271	1104	130	1144G	134	1169GBM/D3	137
195AS	39	1052K	531	1104R	130	1144G/RL	134	1171BM	137
195AS/B	39	1053	126	1105	130	1144L	134	1172BM	137
195K	528	1054	127	1105/C10T	131	1148A	134	1172BM/P	137
195P	39	1055	127	1105/C15T	131	1148A/R	134	1173BM	137
195P/B5	39	1056	127	1105/C29T	131	1148B	134	1175BM	137
1002	124	1057A	127	1105AD-50	131	1148B/R	134	1177BM	137
1008	124	1058	127	1105T20	130	1148P	134	1177BM/Z	137
1008BM	124	1059	127	1105T30	130	1149F	134	1178BM	138
1009	124	1060	127	1105T50	131	1150	135	1178BM/P	138
1009L/A	124	1061	127	1112	131	1150BA	286	1182BM	138
1009L/B	124	1062	127	1112K	532	1150BM	135	1183BM	138
1009L/C	124	1062AL	127	1114	131	1150BM-HS	272	1184BM	138
1009L/D	124	1062GM	127	1118	131	1150BMK	533	1185BM	138
1009L/DP	124	1063	128	1120A	131	1150G	135	1186BM	138
1010	124	1064	128	1120ARL - ARG	131	1150GBM	135	1188BM	139
1010BM	124	1065F	128	1122	131	1150GBMK	533	1190BM	139
1010MQ	265	1065P	128	1122 - 1125MOL	132	1150GK	533	1191BM	139

ALPHANUMERIC INDEX

1191BM/L	139	1256TX	143	1273MQ/F-D6	266	1297TX/S12	150	1366S/R8	155
1191R/5-M	139	1257BE	144	1274MQ	266	1298RTX	150	1366S/R9	155
1200MS	139	1257ES	144	1274MQ/F	266	1298RTX/S8	150	1366S/R10	155
1201E	139	1257ESB/S8	144	1274MQ/S	266	1298RTXK	536	1366S/R11	155
1201E/DZ	139	1257LP	143	1275MQ/C	266	1299HS	272	1366S/R12	155
1201E/K	534	1257LP/S	144	1276MQ/C	267	1299N/PZ	150	1366S/R13	155
1201E/S6	139	1257LPH/S8	144	1277BA	286	1299N/PZK	536	1366S/R14	155
1201EN	139	1257PH	144	1279MQ	267	1299PZ	150	1366S/R21	155
1201EN/K	534	1257TX	144	1279MQ/F	267	1299PZ/S6	150	1366S/R22	155
1202E	140	1257TX/S	144	1279MQ/S	267	1299PZK	536	1366S/R24	155
1202E/K	534	1260	144	1281/B28A	148	1302	150	1366S/R25	155
1202E/S4	140	1260/S6	144	1281BG	147	1303	151	1366S/R26	155
1202EL	140	1260E	145	1281BG/A9	147	1304	151	1366SL	154
1202EN	140	1260EK	535	1281BG/B28A	148	1305	151	1366ST	154
1202EN/K	534	1260K	535	1281BG-TX/A8	147	1305Z	151	1367/K10	155
1203/E1P	541	1260N	144	1281LP	147	1306	151	1367/S4	155
1203/E4P	541	1260NK	535	1281LPH	147	1307	151	1368	156
1203/E5P	542	1262	145	1281PB	147	1308	151	1368G/C2U	156
1203/E10P	542	1262/S4	145	1281PE	147	1309	151	1368G/CV	156
1203E/D	140	1262E	145	1281PH	147	1310	151	1368G/K400	156
1203E/S	140	1262EK	535	1281PM	147	1312	151	1368G/OD	156
1204E	140	1262K	535	1281PZ	147	1313	151	1368G/SD	156
1204E/K	534	1262L	145	1281RTX	147	1314	151	1369/C11	156
1204E/S5	140	1262N	145	1281TX	147	1326	151	1370	156
1204EL	141	1262NK	535	1290	148	1327	151	1370/MR...	156
1205E/ES	141	1263/D...	145	1290/S	148	1328	151	1370BA	287
1205E/ES-S8	141	1263/E39	543	1290HS	272	1329	152	1370BA/MR	287
1206E/BP	141	1263/E40	543	1290INOX	278	1330	152	1370BA/PL	287
1206E/BP-S7	141	1263/E50	543	1290K	536	1331	152	1370F	156
1207E TX/K	534	1263/E62	543	1290K/INOX	536	1335BM	152	1370F/MR...	157
1207E/TX	141	1263/E70	542	1290N	148	1337/S5	152	1370FT	157
1207E/TX-D	141	1263/E74	542	1290NK	536	1338	152	1370FT-HS	272
1208E/RTX	141	1263/E78	542	1292	148	1338A - 1338B	152	1370INOX	278
1208E/RTX-D	141	1263/E85	542	1292/S4	148	1338R9 - 1338R12	152	1370T	156
1208E RTX/K	534	1263/S12	145	1292HS	272	1342	152	1370T-HS	272
1209E/PZ	141	1264	145	1292INOX	278	1342PM	152	1374F	157
1209E PZ/K	534	1264/S5	145	1292K	536	1342PMR	152	1374F/MR...	157
1209E/PZ-S4	141	1264K	535	1292K/INOX	536	1343	152	1375	157
1209EN/PZ	141	1264L	146	1292L	148	1344	152	1375/MR	157
1209EN-PZ/K	535	1265ES	146	1292N	148	1345	152	1375A	157
1229LP	142	1265ES/S8	146	1292NK	536	1351	152	1375B	157
1229LP/S	142	1266BP	146	1293/D...	149	1353	152	1375BA/PL	287
1229LPH/A6	142	1266BP/S8	146	1293/S...	149	1357Z/45	153	1376X	157
1229PH	142	1267TX	146	1293BP	149	1359T	153	1376X/MR	157
1236B	142	1267TX/D7	146	1293BP/S	149	1360/K6	153	1376XT	157
1238B	142	1267TX/S13	146	1293BX/DA	544	1360/KP3	153	1376XT/MR	157
1241	142	1267TXK	535	1293BX/DD	544	1360G	153	1377	157
1242	142	1268RTX	146	1293BX/DE	544	1361/C12	153	1377/MR...	157
1243/D7	142	1268RTX/S8	146	1293BX/DF	544	1362	153	1377BA	287
1250	142	1268RTXK	535	1293ES	149	1365/K13	153	1377BA/PL	287
1251	142	1269N/PZ	147	1293ES/S7	149	1365P10	153	1377INOX	278
1252/S5	142	1269N/PZK	535	1293INOX/D8	278	1366/K5	154	1377T	158
1253	143	1269PZ	146	1294	149	1366A	153	1378	158
1253A	143	1269PZ/S4	146	1294/S7	149	1366KF	154	1378/MR...	158
1254	143	1269PZK	535	1294HS	272	1366S	154	1379BA	287
1256/20	143	1270BA	286	1294K	536	1366S KIT	154	1379F	158
1256/30	143	1272BA	286	1294L	149	1366S/R1	154	1379F/MR...	158
1256/C36-2	143	1272MQ	266	1295	149	1366S/R2	154	1380	158
1256LP	143	1272MQ/F	266	1295/C14	150	1366S/R3	154	1380/MR...	158
1256PE	143	1272MQ/S	266	1297TX	150	1366S/R4	154	1380BA	287
1256PH	143	1273MQ/D6	266	1297TX/D6	150	1366S/R5	154	1380BA/MR	287
1256PZ	143	1273MQ/E1	543	1297TX/L	150	1366S/R6	154	1380BA/PL	287
1256RTX	143	1273MQ/E2	543	1297TX/L-S5	150	1366S/R7	154	1380S	158

ALPHANUMERIC INDEX

1380S/MR...	158	1461/C6G	163	1467/RK2	170	1478	175	1489/31T	180
1380T	158	1461/C7B	163	1467LF/2	170	1478/3P	175	1489/33	180
1381	158	1461/C8B	163	1467LF/RC	170	1478T	175	1489/33P	180
1381/MR...	158	1461/C8G	163	1467TU	170	1479	175	1489/C14	180
1381BA	287	1461/C9B	163	1468N	170	1479/B27	175	1489/E	180
1381BA/MR	287	1461/C10G	164	1470	170	1479L/S2	175	1489/Y	180
1381BA/PL	287	1461/C11A	164	1470FT	170	1479LB/C5	175	1489R	180
1381T	158	1461/C11G	164	1470PF	170	1479LV/S3	175	1490	180
1385	159	1461/C12A	164	1471	171	1479ML/B17	175	1490/R1 - 1490/R2	180
1385/MR	159	1461/C12G	164	1471A	171	1479ML/S3	175	1490F	181
1390	159	1461/C13A	164	1471CF	171	1479N/S5	175	1491	181
1390/MR...	159	1461/C13B	164	1471CM	171	1479RB/1	176	1491A	181
1390BA	287	1461/C17B	164	1471CM/E11	172	1479RB/2	176	1491R	181
1390BA/R	288	1461/C18B	164	1471D2	172	1479RB/3	176	1491T	181
1390HS	272	1461/C20G	165	1471GF	171	1479U/13	176	1492/1 - 1492/2	181
1390N	159	1461/C21G	165	1471M/50	171	1479U/32	176	1492T	181
1390NR	159	1461/C22B	165	1471M/C22	171	1480	176	1493	181
1390R	159	1461/C23B	165	1471M/P	171	1481/C12	176	1493/C7	183
1391	159	1461/C24B	165	1471M/W50	171	1481K/S4	176	1493/C19	182
1391A	159	1461/C25G	165	1471PN/B1	171	1481PL	176	1493/C30	182
1392	159	1461/C26B	165	1471PN/B2	171	1481PL/S3	176	1493/PF	181
1392HS	273	1461/C27G	165	1471PN/B3	171	1482	176	1493/S-U	183
1392R	159	1461/C28B	165	1471PN/B4	171	1482/8 - 1482/10	177	1493AL	182
1393	159	1461/C29B	166	1471PN/B5	171	1482A/1	177	1493AL 4S	182
1410/M	160	1461/C30G	166	1472	172	1482A/3	177	1493AL CF	182
1428	160	1461/C31B	166	1472AU	172	1482A/5	177	1493B	181
1428L	160	1461/C32G	166	1472AU/P	172	1482B	177	1493B/S5	181
1428L/B3	160	1461/C33B	166	1472AU/RP	172	1482C	177	1493DSG	182
1428/SB11	160	1462AD/BSC	167	1472FC	172	1482D	177	1493FF	182
1429	160	1462AD/SMN	167	1472FC/GE	172	1483K/12	177	1493FT	182
1429/SB7	160	1462/EI	167	1472FC/L	172	1483K/22	177	1493H	183
1430/...	160	1462/KD	166	1472FCA	172	1483KV-PT/S7	177	1493J	182
1430/S	160	1462/KI	166	1472FCL/RP	172	1484	177	1493VW	182
1431/...	160	1462/KMRC	167	1472H	172	1484PSA	178	1493X	183
1431/C5	160	1462/KU	167	1472MT/VW	172	1485/KIT	178	1493Y	183
1433	160	1462CF	166	1472R/AU	172	1485BP	178	1494	183
1433/C11	161	1462CF/C6	166	1472TM	173	1485BPM	178	1494/C14A	184
1435	161	1462CF-SN/C6	166	1472VW	173	1485FCA/K2	178	1494BMW	183
1435R	161	1462PIM	167	1473	173	1485FCA/T	178	1494E	183
1435/1	161	1463/KIT	167	1473A	173	1485FCA/TS	178	1494FPC	183
1435/1R	161	1464AP	168	1473FN	173	1485FRD/T	178	1494Q	183
1437/C12	161	1464AP T	168	1473Q	173	1485MJ	178	1494T	183
1438	161	1464AP T16X12	168	1473P	173	1485MRC/T	178	1494VW	183
1438DCT	161	1464ADB	168	1473T	173	1485PMTJ	178	1494VW/K	184
1438DSG	161	1464APB	168	1474/C4	173	1485R	179	1494M	184
1438EVO	161	1464FAP	169	1474E/VW	173	1485R/P10	179	1494XZN	183
1438R	161	1464FG	168	1474E/VW2	173	1485R/P17	179	1495M	184
1438SAC	161	1464FG/CP4	168	1474DL	174	1485TC	178	1495/C6	184
1439/K7	162	1464IC	168	1474G	174	1485VAG	179	1495T	184
1440/...	162	1464IC/RK	168	1474L	173	1485VAG/K2	179	1496/C	184
1445/1 - 1445/2	162	1464PB	168	1475U	174	1485VLV/T	178	1497/C23	185
1450GC	162	1464PF	169	1476	174	1486/10	179	1497/C94	185
1452K	162	1464PT	169	1476/RC	174	1486/20	179	1497/S3	185
1452PN/K	162	1464T	167	1476A	174	1486/30	179	1497CEL	184
1455SVP	162	1464T/SP80	167	1476A/RC	174	1486/40	179	1497D	184
1455SVP/R...	162	1464TDI	169	1476C/1	174	1486/50	179	1497KB/S3	185
1456/C8	162	1464VD	169	1476GT	174	1486/60	179	1497P	184
1457/B4	162	1465	169	1476PSA	174	1486/70	179	1497RC	185
1458	163	1466/C5	169	1476T	174	1486/80	179	1498	185
1460F	163	1466L 11	169	1477/C10	174	1486/90	180	1498/2A	187
1461/C3B	163	1466TLF	170	1477D	174	1488 - 1488L	180	1498/2A-8A-PR	187
1461/C5G	163	1467	170	1477D/S5	174	1488/1	180	1498/4A	187
1461/C6B	163	1467/RK1	170	1477K/7	175	1488R...	180	1498/4A-8A CO	187

ALPHANUMERIC INDEX

1498/4A-8A CP	187	1540	193	1599T	199	1658SP/1	203	1701PMR	208
1498/8A	187	1542/1 - 1542/2	194	1600Q 8	199	1659	203	1702N	208
1498/12	186	1544/...	194	1600Q 10	199	1662/1 - 1662/2	203	1702N/PM	208
1498/12-24 R20	186	1545/C5M	194	1601/PC	199	1662AN	203	1702PMR	208
1498/16A	187	1547/C6	194	1602	199	1662DGT/A	203	1703BA/A	288
1498/24	186	1547KP	194	1602/C9	200	1662SP0	203	1703BA/P	288
1498/30A	188	1547P	194	1602A	200	1662SP2	204	1703BA/PL	288
1498/40A	188	1547PC/2	194	1602A-HS	273	1666	204	1704	209
1498/50A	188	1547PL/2	194	1602BA	288	1666A	204	1704A	209
1498/120A	188	1549	194	1603	200	1668	204	1704C	209
1498B12/R02	186	1550U	195	1603A	200	1668A	204	1705	209
1498C/24	186	1550U/CGS-R	195	1603B	200	1670	204	1705PT	209
1498LT/12	186	1550U/MRC-ABE	195	1603BK	537	1670A	204	1706DGT	209
1498LT/12-R7	186	1550U/MRC-C	195	1603K	536	1672	204	1707	209
1498LT/12-SF	186	1550U/S...	195	1606/2	200	1672A	204	1707A/1 - 2 - 3	209
1498MN/12	185	1550U/SS187	195	1606A	200	1674A	205	1708/8 - 13 - 20	209
1498MN/12-C	185	1550U/M	195	1606A/C9	200	1676	205	1708HS/20	273
1498MN/12-P	185	1551/C20	195	1606T	200	1678/C3	205	1709/10 - 1709/18	209
1498MN/12-R	185	1552/C9	195	1607	200	1679	205	1710	209
1498MN/12-U	186	1555/Q	196	1608	201	1679/PR	205	1712E/1 - 2 - 3	209
1498PC	189	1555/QS	196	1608/C9	201	1680	205	1712E/L1	209
1498SA/2A-4A	187	1555C	196	1608A	201	1680A	205	1712E/R-L1	210
1498SM	188	1555S/BMW-RNT	196	1609	201	1680B	205	1712TF	210
1498SM-A	189	1556/1A	196	1609A	201	1680C	205	1713M	210
1498SM-C	189	1556/2A	196	1609B	201	1682	205	1714	210
1498SM-CP	189	1557	196	1609C/C5	201	1682HS	273	1715	210
1498ST/TB	189	1557/S3	196	1609M	201	1683	205	1715B/R5L	210
1498ST/TB ROT	189	1557V	196	1610-B	521	1685/C7	206	1715FL/A	210
1498TB/12-24	189	1558/C4	196	1614-P	521	1687A	206	1715FL/B	210
1498TC	189	1558/C13	196	1616-SM	521	1687AC	206	1715R/FL	210
1499	189	1558P	196	1618-SF	521	1687D	206	1716A	210
1500/...	190	1559	197	1620-M	521	1687U	206	1716P	210
1500/SP	190	1559V/8T	197	1622-F	521	1687/S4	206	1716Q	210
1500G/...	190	1560/1 - 1560/2	197	1624-FI	521	1688	206	1716R	210
1500N/...	190	1560A	197	1628-C	521	1688A	206	1716U	210
1500N/G...	190	1561/...	197	1630-CR	521	1688M	206	1717A	210
1500N/SP	190	1562D	197	1632-TS	521	1688PC	206	1717B	210
1501/1 - 2 - 3	190	1565/1 - 2 - 3	197	1634-TD	521	1688PC/R	206	1717BA	288
1501G/1 - 2 - 3	190	1566/GO1	197	1635-S	522	1690F	206	1717BA/1	288
1501Z/S - P - R	190	1566N	197	1639EAB	525	1690L	206	1717C	210
1505/C5	191	1566P	197	1639ESB	525	1691BM	206	1717D	210
1505V	191	1567	197	1639ESC	525	1692	206	1717T	210
1506	191	1569/A	197	1639ETA	525	1692HS	273	1717T RS	211
1508/1 - 1508/2	191	1569/B	197	1639S	201	1693	207	1717T RT	210
1511/1 - 2 - 3	191	1569/F	198	1640	201	1693M	207	1717V	211
1515/1 - 2 - 3	191	1569CP	198	1640A	202	1694/L	207	1717V R	211
1516/1 - 2 - 3	191	1570/3	198	1640K	201	1694A/L	207	1718A...M	211
1517	191	1580/8I	198	1640P	202	1694B/L	207	1718A...P	211
1518/...	192	1580GL	198	1640Q	202	1695XS	207	1718A...Q	211
1520/1 - 1520/2	192	1585/5I - 6I - 7I	198	1640T	202	1696	207	1718A...R	211
1528	192	1585G/5 - 6 - 7	198	1650	202	1696A	207	1718A...S5	211
1529	192	1589PI/50 - 100	198	1650FD	202	1696B	207	1718A...T	211
1529/C7	192	- 150		1650FT	202	1696D	208	1718D...M	211
1529/PG	192	1589VI	198	1651DGT	202	1696S	208	1718D...P	211
1529PI	192	1590	198	1651DGT/IP	202	1699L	208	1718D...Q	211
1530/C5	192	1591	198	1652	202	1699L/1	208	1718D...R	211
1530/C16	193	1593	199	1654	202	1699Q	208	1718D...S5	211
1532	193	1594	199	1654DGT	202	1700N	208	1718D...T	211
1533/...	193	1595	199	1656	202	1700N/PM	208	1719BA8	288
1533PR/1 - 2 - 3	193	1599B	199	1657DGT/2	203	1701BA	288	1719BA12	288
1534/...	193	1599G	199	1658/...	203	1701N	208	1719BMA...B5	212
1535/C...	193	1599F	199	1658/C4	203	1701N/PM	208	1719BMA...M	212
1539	193	1599P	199	1658DGT	203	1701NE/...	208	1719BMA...P	212

ALPHANUMERIC INDEX

1719BMA...Q	211	1741U	216	1756D-2OR	219	1771	226	1833XS/1	229
1719BMA...R	212	1742	216	1756G	219	1771BM	226	1833XS/2	229
1719BMA...S5	213	1742/C4	216	1757	219	1771HD	226	1834RR	230
1719BMA...T	212	1742A	216	1757A	219	1771RL	226	1836A	230
1719BMB/P	213	1742A/C	217	1758	219	1772H	226	1836B	230
1719BMC	213	1742A/KR	216	1758A	219	1772H-HS	274	1837C	230
1719BMD...B5	212	1742KR	216	1758B	219	1772M	226	1837F	230
1719BMD...M	212	1742R-A/M...	216	1758B-RNT	220	1772R	226	1837F/USB	230
1719BMD...P	212	1742R-AL/M...	216	1758BA	288	1772RL/2	226	1837M	231
1719BMD...Q	211	1743	217	1758LG	220	1773A	226	1837RB-F/USB	230
1719BMD...R	212	1743HS	273	1758M	220	1773RL	226	1837S	231
1719BMD...S5	213	1743T	217	1758R	220	1774	226	1838/11LED	231
1719BMD...T	212	1748-BA1	524	1758VT	220	1774A	226	1838COB	231
1719BMX...M	212	1748-BA2	524	1758VT/L	220	1774A/RL	226	1838FLASH	231
1719BMX...Q	212	1748-BH	524	1759	220	1774S	226	1838P	231
1719BMX...P	212	1748-BL	523	1759A	220	1776BA	288	1838RA/10-11LED	231
1719BMX...R	212	1748-BP	524	1759B	220	1777BM	227	1838RB/10LED	231
1719BMX...T	212	1748-BR	523	1759HD/3	220	1777BMT	227	1838RR/11LED	231
1719BMX...S5	213	1748-BT	524	1759HD/RR	221	1777MQ/C	267	1838RV/11LED	231
1719BM/RL	213	1748-BT2	524	1759HD/TRUCK	221	1777MQ/U	267	1838RB/FLASH	231
1719BM/RR	213	1748-BT3	524	1759TT	221	1777RL/U	267	1838S	232
1719BMR	213	1748-BV0	523	1760/IR500	223	1777T	227	1838SL	232
1719R/...	213	1748-BV2	522	1760/IR1000	224	1778AX	227	1838SLIM	232
1720/...	213	1748-BX	523	1760/IR1600	224	1778CM	227	1838UV	232
1720/B	213	1748-N2D	523	1760/OHM	222	1778D	227	1839/R1	232
1720/S	213	1748-NA1	524	1760/RMS	222	1778P	227	1839/R2	232
1720D/...	213	1748-NA2	524	1760/RSE	223	1778SCL	227	1839/R4	232
1720D/B	214	1748-NL	523	1760/TC2	223	1778SOS	227	1840BM	232
1721/B6	214	1748-S	525	1760B	222	1778SOS-HS	274	1842LED/ABM	232
1723	214	1748-SC	525	1760BHS	273	1778U	227	1842LED/BM	232
1725	214	1748-ST	525	1760DGT	221	1778V18	227	1843BM	232
1725CR	214	1748-UL	522	1760DGT/2	221	1778X	227	1843R/BM	233
1725MQ	267	1748N	522	1760DGT-R3	223	1781	228	1846LED/ABM	233
1726	214	1749	217	1760K	223	1783	228	1846LED/BM	233
1726BM	214	1749A	217	1760PA/80	222	1784	228	1846R-LED/BM	233
1727	214	1749A/RB	217	1760PA/AC	222	1784BA	288	1848	233
1727BA	288	1749A/RT	217	1760PA/AC-DC	222	1800/100	228	1850B	233
1727BM	214	1749AC	217	1760PT	223	1808	228	1850C	233
1727HS	273	1750	217	1760R/TC2	223	1812 150	228	1850U...	233
1728...	214	1750CG	217	1760TMC	224	1814M	228	1851VK	233
1728BA	288	1750HS	273	1761	224	1820	228	1851VK-12C	233
1729	214	1750KG10	218	1761RS/1	224	1820 60	228	1851VK-12V	233
1729CG	214	1750M	218	1762	224	1820 80	228	1852R1750	234
1729DM 450	214	1750R/1 - 1750R/2	217	1762K	537	1822	228	1852S-F	234
1729LR	214	1750RC	217	1763	224	1822 180	228	1852S-FLESS	234
1730	214	1750RP/1 -	217	1763G/S500	224	1822 320	228	1852S-L	234
1730INOX	278	1750RP/2		1765/C24	224	1823 60	228	1852 S-PIATTE	234
1730M	214	1750RT	217	1766	224	1823R/60	228	1860 140A	234
1730V 38	214	1750TA	218	1766/8	225	1824R	228	1860 160A	234
1736A	215	1750TLA	218	1766A	225	1825B	228	1860EI	234
1737	215	1751	218	1766ER	225	1827	229	1860RC	234
1737AC	215	1751R	218	1766G	225	1827/K	229	1860RG	235
1737B	215	1752	218	1766I	225	1827F	229	1860SQ	235
1737BA	288	1752R	218	1766L	225	1827PC	229	1870	235
1737NX	215	1753	218	1766LI	225	1827PCL	229	1870-20/5S	236
1738	215	1753R	218	1766T	225	1827PFL	229	1870-72 /FC	236
1739B	215	1754	218	1767A	225	1830T	229	1870-72/FL	237
1740A	215	1755	219	1767PMC	225	1833L	230	1871M	236
1740B	215	1756	219	1767PMR	225	1833L/USB	229	1871M/AS	236
1741B	215	1756B	219	1770	225	1833M	230	1872L	236
1741B/C5	215	1756C	219	1770A	226	1833RB-L/USB	229	1872L 35/FC	237
1741BP	215	1756C-2OR	219	1770BM	226	1833S	229	1872L 35/5S	237
1741RV...K	216	1756D	219	1770RL	226	1833XL	230	1873	236

ALPHANUMERIC INDEX

1873-30/5S	237	1895 27	242	1924F	293	1938R/S5	302	1996MQ/T	267
1874	236	1895/RC	242	1927AN	295	1940	303	1996SVG	267
1874-50/5S	237	1895/S	242	1927B	294	1940/S5	303	11001	505
1874-50/FC	237	1895G	242	1927CD	294	1940E10	303	11001H	505
1877	237	1897	243	1927G	295	1940E10/MT	303	11003	505
1877A	237	1897/CRB	243	1927P	294	1940E10/S...	303	11011	505
1878 2	237	1897/G	243	1927SP-AM	295	1940E10/S5	303	11011H	505
1878 3	237	1897/KSA	243	1927XM	294	1940MT	303	11018	505
1878 4	237	1897/MV	243	1928CD	295	1940S...	303	11019	506
1878 8	237	1898/B	243	1928DA	295	1942A	304	11021	506
1878 11	238	1898/D	243	1928DAL	295	1942LR	304	11023	506
1878 30	238	1898/K40	243	1928K4	296	1944A	304	11024	506
1879	238	1901BM/8	309	1928XM	295	1944AR 2	304	11031÷11038	506
1879 6	238	1901T/10	309	1930A	296	1944N	304	11032	506
1879/FUEL	238	1910/8 - 1910/10	309	1930CD	296	1944PA	304	11034	506
1879R/K4	238	1914	309	1930HLA	297	1945C	304	11035	506
1880	238	1915B	309	1930LA	296	1945C/G...	305	11037	506
1880ADB	238	1915C	310	1930LH	296	1945C/GP...	305	11038	506
1881	238	1915C/L	310	1930PA	296	1945P	305	11040	507
1882	238	1915D	310	1930ZL	297	1945P/S...	305	11045	507
1883	238	1915E	310	1931AN10	297	1945S	304	11046	507
1883NC	238	1915E/XL	310	1931CD6	297	1945S/G...	304	11048	507
1884	239	1916G	310	1931CD10	297	1946C/T...	305	11049	507
1884/C12	239	1916GF	310	1931CD13	297	1946C4,8	305	11050	507
1889	239	1916GFE	310	1932B10	298	1946C7,8	305	11069	507
1889CF	239	1916I	310	1932B13	298	1946KF	306	11100	508
1885	239	1916JF	310	1932RS13	298	1946KF/M...	306	11101	508
1885/C1	239	1916JM	310	1933	298	1946T	305	11102	508
1885/C1-R1	239	1916P	310	1933AN90	299	1947	306	11105	508
1885/C1-R2	239	1916S	310	1933AN90-H	298	1947G	306	11106	508
1885/C1-R3	239	1917F	311	1933I	299	1947H	306	11107	509
1885/C1-R4	239	1917JF	311	1933IH	298	1947M	306	11110	509
1885/C1-R5	240	1917JM	311	1933IL	299	1947M -...	306	11111	509
1885/C1-R6	240	1917M	310	1933ILH	298	1948	306	11115	509
1885/C1-R7	240	1917RG	311	1933L	299	1948PR	307	11116	509
1885/C1-R8	240	1917SP	311	1934BV	299	1949BC	307	11120	509
1885/C2	240	1917ST	311	1934MAV	299	1949BC/RU	307	11121	510
1885/C2-R1	240	1918	311	1934MAV70	299	1949DGT	308	11125	510
1885/C2-R2	240	1918N	311	1935F	300	1949F	308	11130	510
1885/C2-R3	240	1918R	311	1936/4A	300	1949G	308	11131	510
1885/C2-R4	240	1919F1/2	312	1936/5A	300	1949GPE	308	11132	510
1885/C2-R5	240	1919F1/4	312	1936/7A	300	1949GPN	308	11135	510
1885/C2-R6	240	1919F3/8	312	1937	300	1949M	308	11140	511
1885/C2-R7	240	1919FE1/4	311	1937 2,5	300	1949P	307	11141	511
1885/C3	240	1919L	312	1937C...	301	1949T	308	11145	511
1885/C3-R1	240	1919ML	312	1937K...	301	1949U5	307	11200A	511
1885/C3-R2	240	1919RB-F	312	1937KC	301	1949U5/A	307	11200B	511
1885/C3-R3	240	1919RB-FE1/4	311	1937KL	301	1949U5/B	307	11202A	511
1885/C3-R4	241	1919RF-F	312	1937KL-D	301	1949U5/C	307	11202B	511
1885/C3-R5	241	1919RF-FE1/4	311	1937M	302	1949U5/D	307	11202C	511
1885/C3-R6	241	1919RM-FE1/4	311	1937M-01÷11	302	1949U5/E	307	11204A	512
1885/C3-R7	241	1919RM-F	312	1937N10	302	1949U5/F	307	11204B	512
1885/C3-R8	241	1919SC	312	1937N10-GR	302	1949U5/G	307	11204C	512
1885/C3-R9	241	1921B1	293	1937N20	302	1951	309	11208A	512
1885/C3-R10	241	1921M1	293	1937N20-GR	302	1951A	309	11208B	512
1893/134A	241	1921M2	293	1937R/P	300	1952	309	11210A	512
1893/1234YF	241	1921N3	293	1937RT	301	1972/12	289	11210B	512
1893TR/134A	241	1922P1	293	1937RT/R	301	1984/18QM	289	11210C	512
1893TR/1234YF	241	1922P2	293	1937RT/T	301	1995MQ/G1 - G2	267	11212A	512
1893TR/CI	242	1922P3	293	1938	302	1995MQ/T	267	11212B	512
1895 6	242	1924B	294	1938R/L	302	1996MQ/GM	267	11214A	513
1895 13	242	1924CD	294						

ALPHANUMERIC INDEX

3027 50	249	3092	256	4	419	50	446/C30	59
3027/KP	249	3093/E	256		419T	50	446/C48	59
3027/KPP50	249	3093/U	256		420A	50	446/C110	59
3027/PR	249	3500/D	344		420B	50	446ASC/C37	60
3029/2T	249	3500/P	344		42/SP25	24	446ASF/C29	59
3029/2T-L/R5	250	3700-COVER C37	355		42AS	25	446ASG/C23	60
3029/2T-L/R6	250	3700/PC	349		42AS/B	25	446ASW/C36	59
3029/2T-L/RP	250	3700/PF	349		42AS/S	25	447/C37	60
3029L/2T	249	3700/PFL	349		42BA	281	447/C53	60
3030/2T	250	3700/PLA	349		42BA-AS	281	447/C70	60
3030/2T-R5	250	3700/PLL	349		42HS/AS	269	424	60
3030/2T-R6	250	3912P	258		42INOX	276	424/SP	60
3030/2TRP	250	3912T	258		42INOX-AS	276	425	61
3033/3T	250	3912T/AD12	258		42INOX-AS/S9	276	425/SP	61
3035	250	3912T/AD15	258		42INOX/S	276	426	62
3036	250	3912T/AD20	258		42INOX/SC9	276	426/SP	61
3040C	253	3912T/ADC	258		42LMP	25	426MD-3/A9	61
3040C/S1	253	3916MM	258		42LMP/S	25	426MD-3/CP3	61
3040C/S2	253	3921	258		42MP	25	426MD-3/CT3	61
3041C	253	3923	258		42MP/B	25	426MD-3/F3	61
3041C/12	253	3927	258		42MP/S	25	426MD-3/FA3	62
3041C/16	253	3932U	258		42N/SC9I-E	24	426MD-3/OG3	62
3042C	253	3935	258		42N/SP25	24	426MD-3/OV3	62
3043C	253	3937	258		42NEW	24	426MD-3/S3	62
3043C/ 41+47	253	3948	258		42NEWH	269	426MD-3/T3	62
3047C	253	3952	259	42NEWH	269	426MD-3/TA3	62	
3048C	253	3952/S	259	42NEWK	527	426MD/CP	63	
3050/CC	253	3953	259	42SLIM	26	426MD/CT	63	
3050/600	254	3955	259	42SLIM/S11	26	426MD/F	63	
3050/KA	254	3961 3,2	259	45	26	426MD/FA	63	
3050/LA	254	3961 3,3	259	410	46	426MD/OG	53	
3050/MS	254	3961 3,5	259	410/SEL	46	426MD/OG	53	
3050/MV	254	3961U	259	410/SP	46	426MD/OV	53	
3054	254	3962MV	259	410A	46	426MD/S	53	
3055M	254	3962SH	259	410AS	46	426MD/SP10	53	
3057	254	3963P	259	410AS/SEL	46	426MD/T	53	
3061/2T	251	3964	259	410AS/SP	46	426MD/TA	53	
3061/2T-P50	251	3965	259	410MIX/SEL19	46	426SB	52	
3061/2T-P100	251	3965C	259	412	47	426SB/SP	52	
3065/20-10T	251	3967	259	412/C150	47	426T	51	
3065/40-20T	251	3969	259	412/SP	47	426T/SP	51	
3067/60-15T	251	3969K3	259	412/SP91	47	427	53	
3067/70-13T	251	3971	260	412A	47	428/C14	54	
3070B	254	3972	260	412C	47	428FC	53	
3070BE/B	255	3973/1	260	412L	47	428FP	53	
3070BE/F	255	3973/2	260	412XL	47	428/C14	53	
3070BE/K	255	3973/3	260	414	48	429/C14	54	
3070BE/S	255	3973/4	260	414/C116	48	429FC	54	
3073	255	3973PF	260	414/SP	48	429FP	53	
3075/CM	255	3975	260	415	48	430	54	
3075/K10	255	3984/1	260	415/C116	49	430/SP	54	
3075A	255	3984/2	260	415/SP	48	430ASC	54	
3075B 55	255	3984/3	260	415/SP91	49	430ASW	54	
3075MV	255	3984/4	260	415C	49	431	54	
3079/21	255	3984/5	260	415CO	49	431/SP	54	
3080/C15	256	3984/6	260	415CO-A	49	433	54	
3080R/CS3	256	3991	260	415CO/SP19A	49	433ASF	55	
3081	256	3992	260	415L	49	433ASG	55	
3085	256			416	49	434	55	
3091	256			416/SP19	49	435	55	
				417	50	440B	57	
				417/SP	50	442	58	
						444	58	

5

52	26
52MQ	263
53	26
55	26
55/B	26
55/S	27
55/SP	27
55AS	27
55AS/S	27
55BA	281
55BA-AS	281
55HS	269
55K	527
55MP	27
55MP/S	27
58	27
58BA	282
58BA-AS	282
560/C2	63
560/C3	63
560/C3PLUS	63
560/C4+	63
560/C6	63
560/C12	63
561/1	63
562/1 - 562/2	64
562VV-A	64
564/3R - 564/4R	64
565/1R - 565/2R - 565/3R	64

ALPHANUMERIC INDEX

565/4R	64	5958U	440	678/CV	72	6600 M/542	550	720MC	73
565/5R	64	5980/MQ	448	680	72	6600 M/548	550	720MC/C13	74
565VV-B	64	5980EL/A	450	682	72	6600 M/561	550	720ME	75
567/4R	64	5980EL/B	451	6888	545	6600 M/583	550	720ME/C8	75
567/5R	64	5980ET/A	446	6200AP/S10	591	6600 M/640	551	720MRC	75
581	65	5980ET/B	447	6600 M/14	546	6600 M/650	551	720S	74
583	65	5980ID	452	6600 M/22	546	6600 M/657	551	720S/SB6	74
583/C31	65	5980U/BIKE	441	6600 M/27	546	6600 M/658	551	720TC	75
588	65	5988 VHB-MQ	449	6600 M/29	546	6600 M/716	551	720TC/S5	75
590 - 592	65	5988H/7M	442	6600 M/33	546	6600 M/813	551	720TX	75
594	65	5988L/4M	443	6600 M/40	546	6600 M/842	551	720TX/C6	75
596 - 598	66	5988U6/M	444	6600 M/42	546	6600 M/852	551	727/C16	76
599DGT	66	5988U7/M	429	6600 M/44	546	6600 M/856	551	727/ES16	76
599DGT-AN	66			6600 M/47	546	6600 M/857	551	727/ES16TX	76
5000MS	361	6		6600 M/51	546	6600 M/871	551	727/ES22	76
5700LAMP	367			6600 M/52	546	6600 M/878	551	727/ES22TX	76
5902MT	453	600	66	6600 M/58	546	6600 M/881	552	727/ES32	77
5902MT/AS	454	601C	66	6600 M/59	547	6800VE	545	727PI/16	76
5902VI	412	601CA	66	6600 M/61	547	6888B1/2	539	727PI/22	76
5904VG/2M	455	603	67	6600 M/62	547	6888B1/4	539	727PI/32	77
5904VG/2T	456	604B	67	6600 M/63	547	6888B3/8	539	728	77
5904VG/3	457	605E	67	6600 M/73	547			728/15	77
5904VG/3T	458	606MQ/50	263	6600 M/112	547	7		728/16	78
5904VG/5T	459	611	67	6600 M/116	547			728/21	78
5904VI/1T	413	612 ÷ 614	67	6600 M/120	547	73	27	728/22	78
5904VI/2T	414	614/50	67	6600 M/125	547	73/B	28	728/22L	78
5904VI/3T	415	615	67	6600 M/126	547	73/S	28	728/25	78
5904VU/1M	422	616	67	6600 M/131	547	78	28	728/C10	77
5904VU/2M	423	617	67	6600 M/174	547	78AS	28	728/OR	78
5904VU/2T	424	619	67	6600 M/175	548	78BA	282	728/SP	78
5904VU/3T	425	621	67	6600 M/217	548	78BA-AS	282	728AS	77
5904VU/4T	426	641	67	6600 M/218	548	710	73	728FTX	77
5905VG/1	460	642	68	6600 M/222	548	710/16	73	728L	77
5905VG/2	461	643	68	6600 M/223	548	710/20	73	728L/S	77
5908VG/2T	462	650A	68	6600 M/230	548	710/21	73	728LQ	77
5908VI/2T	416	650H	68	6600 M/236	548	710/25	73	728LS	77
5908VU/2T	427	652	68	6600 M/241	548	710/C10	73	729	78
5910VG/3T	463	653	68	6600 M/242	548	710/OR	73	729/15	78
5910VI/3	417	659/15	68	6600 M/253	548	710/SP	73	729/16	78
5910VI/3T	418	659/16	69	6600 M/311	548	720	73	729/21	78
5914VU/M	428	665	69	6600 M/315	548	720/15	76	729/22	78
5915VU/0	430	665LB	69	6600 M/320	549	720/16	76	729/25	79
5915VU/1	431	665SW	69	6600 M/326	549	720/20	76	729/OR	79
5915VU/2	432	666HS	270	6600 M/327	549	720/21	76	729/SP	79
5915VU/3	433	666N	69	6600 M/330	549	720/25	76	729L	78
5915VU/4	434	666N LBF.IN	70	6600 M/371	549	720/C12	73	729LS	78
5915VU/5	435	667N	70	6600 M/379	549	720/C6	73	729T	78
5915VU/AS	436	668N	70	6600 M/406	549	720/OR	76	730	79
5927VU/M	437	668RG	70	6600 M/417	549	720/SP	76	730/15	79
5935ET/1MB	445	668RGC	70	6600 M/423	549	720AS	74	733/15	79
5935VG/1MB	464	669N	71	6600 M/424	549	720FTX	75	7041LCD/4S	235
5935VI/2MB	419	671B/C5	71	6600 M/427	549	720FTX/SB	75	7041LCD/4S-VE	235
5938U/2T	438	671B/C10	71	6600 M/430	549	720IC	74	7041LCD/4S-VI	235
5940SBK	465	671N/C10	71	6600 M/440	550	720L	74	7042LCD	235
5941VU/M	466	671N/C20	71	6600 M/456	550	720L/S3	74	7042LCD/RV	235
5945VUM	467	671N/C30	71	6600 M/465	550	720LC	74	7042LCD/RV-INT	235
5954VG	468	677	71	6600 M/480	550	720LC/C3	74	7043	235
5954VI	420	677/C	72	6600 M/485	550	720LC/S5	74	7051MP	590
5957U-P	439	677/CP200	72	6600 M/510	550	720LCL	75	7061TC	590
5957VG	469	678/C	72	6600 M/532	550	720LCL/C3	75	7076BC	590
5957VI	421	677/CV	72	6600 M/534	550	720LS	74		

ALPHANUMERIC INDEX

7076BD	590	7320NA	568	7821	587	851SR	79	867RTX/L	85
7076BP	590	7321NA	568	7823	587	850MQ	263	867TX	85
7076BU	591	7328EA	559	7825	587	852	79	867TX/L	85
7093BC	591	7328EN	559	7829	588	855P	79	867XZN	84
7093BD	591	7340B	572	7830ST	586	860/55	80	867XZN/L	84
7104 90	590	7340R	572	7831ST	586	860/58	80	882	86
7105 6	590	7341N	572	7833ST	586	860/58K	528	882AN	86
7109A	590	7349RP	573	7835ST	587	860/C27	80	882M	86
7109D	590	7350RP	573	7840BL	582	860/C38P	81	882M1	86
7195A	590	7352A	570	7849BL	583	860LP	79	882MSR	86
7200BKK	564	7352B	570	7860G	583	860MIX/A10	81	882P	86
7201BKK	564	7353Y	570	7861G	583	860MIX/A31	81	892	86
7210BKK	564	7354N	571	7863G	583	860PE	80	895	86
7212FG	561	7355V	571	7865G	583	860PE/A10	80	897	86
7212LG	561	7356G	569	7867G	583	860PH	79	897L	86
7213FG	562	7357G	570	7869G	584	860PHZ/A10	80	8001TZ	596
7214FN	562	7362B	571	7880SC	580	860PZ	80	8001TZ-K	596
7214LN	562	7363N	571	7900B	584	860RTX	80	8001Z	595
7215FN	562	7398 0/G	576	7900G	584	860TX	80	8001Z-K	595
7216BKK	565	7398EF	576	7900P	584	860TX/A10	81	8002ZD	596
7217FB	563	7398GEL	576	7900V	584	861/C61P	83	8002ZS	596
7217FG	563	7398U	576	7901G	584	861LP	81	8003ZD	596
7218FN	563	7399A/N	576	7903G	585	861PE	82	8003ZS	596
7219FY	563	7421	576	7903P	585	861PH	81	8004ND	596
7220PEK	560	7423	576	7905G	585	861PH/C	81	8004NS	596
7221PEK	560	7425	576	7904N	585	861PZ	81	8005TZ	594
7223PEK	560	7427	576	7907G	585	861PZ/C	82	8005TZ-K	594
7224PEK	561	7429	576	7907P	585	861RIBE	82	8005Z	593
7235BK	565	7431P	576	7909G	585	861RTX	82	8005Z-K	593
7236BK	566	7525	578	7909V	586	861SP	82	8006Z	594
7238WR	566	7528	578	7909P	586	861TQS	82	8006Z-K	594
7241BK	557	7529	578	7909B	586	861TRW	82	8007Z	594
7241CK	557	7547BL	580	7930G	588	861TX	82	8007Z-K	594
7241EN	556	7547G	580	7931G	588	861TX/C	82	8008N	594
7243BK	557	7547N	580	7933G	588	861XZN	82	8008N-K	594
7243CK	558	7549BL	580	7935G	588	862F	83	8008TZN	594
7243CR	558	7549G	580	7939G	588	862F/A7	84	8009FD	597
7243EN	556	7549N	581	7970	589	862LP	83	8009FS	597
7243FT	558	7575N	581	7971L	589	862PE	83	8009TZ	595
7245BK	558	7577N	582	7978L	589	862PH	83	8009TZ-K	595
7246BK	559	7579T	582	7979	589	862PH/L	83	8009Z	595
7246E	556	7634B	581	7980N	590	862PH-XL	83	8009Z-K	595
7247BK	559	7634G	581	7980R	590	862PZ	83	8010TZ	595
7248GK	566	7635N	581	7984G	590	862TX	83	8010Z	595
7249GK	566	7650	578	7985	590	862TX/L	83	8010Z-K	595
7252NKK	567	7654N	581	7991N	589	862TX-XL	83	8016	598
7253NKK	567	7657N	581	7992N	589	866LP	84	8016DA	598
7293HM	574	7658N	582			866PE	84	8016FR	598
7293HN	575	7659N	582			866PH	84	8016FR-K	598
7294HM	575	7734	582			866PZ	84	8016-K	598
7294HMC	575	7780T	582	80	28	866RTX	84	8016U2	598
7294HN	575	7800G	590	80/S	28	866TX	84	8016UGK	599
7300FT	574	7810	578	83	28	867/...	85	8016U-K	598
7300MK	573	7811	579	83/S	28	867/C20	85	8018E	598
7310CRK	565	7812	579	83AS	28	867/C38	85	8018T	599
7314AB	568	7813	579	83AS/S	28	867/C52	85	8020	599
7314AF	567	7816BL	579	88	28	867PE	84	8020A	599
7315AN	569	7816G	579	88/S7	29	867PE/L	84	8021	599
7317NA	568	7817N	579	89BA	282	867RIBE	85	8025	600
7318AN	569	7819B	580	89MQ	263	867RIBE/L	85	8025-K	601
7319ESD	574	7820	587	851	79	867RTX	85	8026A	601

ALPHANUMERIC INDEX

8026A-K	601	8096SL	607	8188CG/25	627	8515Z	614	93HS	269
8026R	599	8097	607	8188CU/25	627	8515V	614	93K	527
8026R-K	599	8097SL	607	8188F	627	8515CH	614	94	30
8028	601	8098	608	8188F35	627	8531	614	94/S	30
8028-K	601	8098SL	608	8188VFG2	627	8532	614	94K	527
8029R	600	8100	610	8189	627	8535	614	95	30
8029R-K	600	8105	593	8189A	627	8600 R/11	552	95/S	30
8031R	600	8105-K	593	8189PA	627	8600 R/12	552	95BA	283
8031R-K	600	8109	593	8190	626	8600 R/13	552	95FTX	30
8032	600	8109-K	593	8190B	626	8600 R/113	552	95FTX/S	30
8032-K	600	8110	593	8201T	616	8600 R/114	552	96	30
8040EN	603	8114	613	8205	616	8600 R/225	552	96/B	30
8040EN-K	603	8116	613	8206	616	8600 R/412	552	96/BG7	30
8040EZ	603	8120	612	8207	616	8600 R/511	552	96/BGS7	30
8040EZ-K	603	8120B	612	8209	616	8600 R/601	552	96/SC12	31
8041	602	8129	612	8210	616	8600 R/611	552	96/SC9	30
8041-K	602	8143	611	8216	617	8702N	597	96/ST	30
8042EN	603	8146	611	8216-K	617	8709N	597	96/ST6K	527
8042EN-K	603	8146C	611	8220	617	8871	274	96AS	31
8042EZ	604	8130	614	8225	617	8872A	274	96AS/B	32
8042EZ-K	604	8130A	614	8227	617	8872AS	274	96AS/BG7	31
8043	602	8131Z	614	8228	617	8873	274	96AS/G	31
8043-K	602	8131DL	614	8240	618	8877	274	96AS/SC9	31
8044	604	8139DL	615	8240F	618	8877M	274	96AS/T	31
8048	597	8139Z	615	8242	618	8879	274	96BA	283
8049	601	8139ZCH	615	8242F	618	8880	274	96BA/BP	283
8049A	602	8143/RK	615	8248	616	8883	274	96BAF-AS	283
8050 D	615	8146/RK	615	8249	616	8889C1	496	96BP	32
8051S	610	8150	621	8249G	617	8889C2	496	96BP/AS	33
8051S-K	610	8153	622	8250	619	8889C3	496	96BP/ASB	33
8052 - 8055S	609	8156	622	8264	619	8889C6	496	96BP/AS-SC9	33
8057	609	8157	622	8267	620	8889CD	496	96BP/SC9	33
8057R - 8057	609	8158	622	8272	620	8889CS	496	96BPA	33
8058R - 8058	609	8159	622	8273	620	8889I4	496	96BPA/SC9	33
8058R/PS	615	8160	622	8274	618	8889P1	495	96BPC	32
8060R - 8060	609	8161	623	8274A	618	8889P2	496	96BPC/SC9	32
8060R/PS	615	8166	624	8274G	619	8889P3	496	96BP-CL	32
8061F	609	8170	623	8276	619	8889P4	496	96BP-CL/SC9	32
8061R - 8061F	609	8173	623	8276G	619	8889PD	496	96BPINOX	276
8062	610	8176	623	8278	619	8889PS	496	96BPINOX-AS	276
8063	610	8177	623	8279	621		96BPINOX-AS/B8	276	
8064S	610	8178	623	8280	619		96C/AS	31	
8065SC	610	8179A	624	8282	620	96C-AS/SC9	31		
8074	612	8179B	624	8282S	620	90	29	96INOXBP/B	276
8074A	612	8179M	624	8284	620	90/B	29	96L	32
8074G	612	8180	624	8285	620	90/S	29	96L/SC12	32
8080	612	8181	625	8286	620	90/SP	29	96L/SP8	32
8082	612	8181S	625	8287	620	90AS	29	96LBP	33
8083	613	8182	625	8290	621	90AS/S	29	96LBP/SC9	33
8085	608	8182A	626	8293	621	90BA	282	96LC	32
8085R	608	8182E	626	8297C	621	90K	527	96LC/SC12	32
8086	608	8182H	625	8297F	621	91	29	96LC/SC8	32
8090F	624	8182S	625	8302Z	597	91BA	282	96N	31
8090R - 8090	609	8182T	625	8303Z	597	91HS	269	96N/B	31
8091	604	8182TS	625	8317DZ	613	91HS-C	269	96N/G	31
8091SL	605	8183	625	8317SZ	613	92	29	96N/SC12	31
8092	605	8184	625	8381SL	613	92BA	282	96N/SC9	31
8092SL	605	8185	626	8381SP	613	92HS	269	96N/ST	31
8094	606	8186	626	8381SX	621	93	29	96N/ST6K	527
8094SL	606	8187	626	8383C	614	93BA	282	96T	33
8096	606	8188C	627	8383P	614	93C	30	96T/AS	34

ALPHANUMERIC INDEX

96T/S6	33	900/C11Z	91	910/22	96	910ME	95	920/R55Q	110
96T/S11	33	900/C12MZ	91	910/25	96	910ME/SB	95	920/R55X	110
96T/SP	33	900/C13-5	91	910/25K	530	910MQ/21	263	920A	98
96T/SPV	497	900/C13-8	91	910/36A	96	910MQ/22	263	920A/AS	99
96TAS/S	34	900/C24	91	910/40	96	910MQ/55	264	920A/C11	104
96TBP	34	900/C39	90	910/42	96	910MQ/B	263	920A/C12	104
96TBP/S6	34	900/R55	109	910/46	96	910MQ/C16	264	920A/C12X	104
96THS	269	900/R55-Z	109	910/55	96	910MQ/PE	263	920A/C17HR	107
96THS-AS	269	900/SB	86	910/55K	530	910MQ/PT	263	920A/C20	105
96TK	528	900/AN	89	910/55Q	97	910MQ/T	264	920A/C20Q	105
97BTX	34	900/AS	87	910/58	97	910MQ/TX	263	920A/C20X	105
97BTX/B	34	900AS/C10	92	910/58K	530	910MQ/XZN	263	920A/C21	105
97BTX/SC8	528	900AS/C17-MBM	92	910/R55	109	910PE	95	920A/C21X	105
97BTX/SC8	34	900AS/L	87	910/R55Q	109	910PE/AS	95	920A/C33	106
97BTX-C	35	900AS/MB	87	910/R55X	110	910PE/SB	95	920A/SB13	98
97BTX-C/SC8	35	900AS/MB-C17	92	910A	93	910PH	95	920A/SB8	98
97BTXL	35	900AS/MBL	87	910A/AS	93	910PH/SB4	95	920A-AS/SB11	99
97BTXL/SC8	528	900AS/SB11	87	910A/C10	97	910PT	95	920AK	530
97BTXL/SC8	35	900BG/30	89	910A/C16	97	910PT/SB	95	920AL	99
97RTX	35	900BG/30C	89	910A/C16HR	98	910TX	95	920AL/SB11	99
97RTX/B	35	900BG/30K	529	910A/C16Q	97	910TX/SB	95	920AN	102
97RTX/SC8	35	900E-HS/55	270	910A/C17	97	910XZN	95	920AS	99
96TINOX	277	900FL	89	910A/C29	98	911BA	283	920AS/C10	106
96TINOX-AS	277	900FTX	88	910A/SB	93	911BA/16	284	920AS/C15	106
96TINOX-AS/S7	277	900FTX/SB9	88	910A-AS/SB13	94	911BA/20	284	920AS/C17X	107
96TINOX/S5	277	900K	529	910AK	530	911BA/55	284	920AS/L	99
97TTX	35	900L	87	910AL	93	914MQ/A	264	920AS/MBM-C21	107
97TTX/S	35	900L/SB	87	910AL/SB14	93	914MQ-A/S4	264	920AS/SB11	99
97TTX/SP	35	900LP	88	910AN	96	920/15	102	920ASL/SB11	99
97TTXHS	270	900M/35	90	910AS	94	920/16	102	920B	99
97TX	34	900M/55	90	910AS/C13	98	920/20	102	920B/C11	104
97TX/B	34	900M/R55	109	910AS/L	94	920/21	102	920B/C12	104
97TX/BG8	34	900MB	87	910AS/MBM-C18	98	920/21K	530	920B/C12X	104
97TX/G	34	900MB/C19	91	910AS/SB13	94	920/22	102	920B/C20	105
97TX/SC8	34	900MB/C28	92	910AS/SN	94	920/23	102	920B/C20X	105
97TX/ST	34	900MB/L	87	910ASL/SB12	94	920/25	102	920B/C21	105
98XZN	35	900MB/SB	87	910B	93	920/25K	530	920B/C21X	105
98XZN/B	35	900MC	87	910B/C10	97	920/35A	102	920B/C30Q	106
99	36	900MC/C24	92	910B/C16	97	920/36A	103	920B/C33	106
99BA	283	900MC/C32	92	910B/C16Q	97	920/38	103	920B/SB13	99
99SQ	36	900MC/LP	88	910B/C29	98	920/40	103	920B/SB8	99
99ST	36	900MC/PH	88	910B/SB	93	920/42	103	920BL	99
99 VN/...	36	900MC/TX	89	910B/SN	93	920/44	103	920BL/SB11	99
900	86	900ME	88	910BL	93	920/46	103	920BP	101
900/...	89	900ME/SB8	88	910BL/SB	93	920/50	103	920BP/SB	101
900/16	89	900PE/AS	88	910BP	95	920/50F	103	920E-HS/55LC	270
900/20LK	529	900PH	88	910BP/SB6L	95	920/55	103	920ES	102
900/25	89	900PH/SB4	88	910CF	96	920/55INOX	277	920ES/SB	102
900/25K	529	900PT	89	910CF/SB	96	920/55K	530	920ES/XL-SB	102
900/32	89	900PZ	88	910E-HS/55	270	920/55L	104	920FTX	100
900/35A	89	900T/44	90	910FTX	94	920/55LC	103	920FTX/C	100
900/40	90	900TX	89	910FTX/L	94	920/55Q	103	920FTX/L	100
900/42	90	900TX/SB	89	910FTX/LSB	94	920/55X	103	920FTX/LSB	100
900/55	90	900U	88	910FTX/SB	94	920/56A	104	920FTX/SB	100
900/55K	529	900U/SB	88	910FTX/XL	94	920/58	104	920INOX-A	277
900/55Z	90	902R/C6	93	910FTX-XL/C10	94	920/58K	530	920LH/SB7	100
900/55ZK	529	910/15	96	910LP	95	920/C37	106	920LP	100
900/58	90	910/16	96	910M/35	96	920/R50	110	920M/35	103
900/58K	529	910/20	96	910M/55	97	920/R55	110	920M/35L	103
900/C11	90	910/21	96	910M/56	97	920/R55INOX	277	920M/55	104
900/C11HR	92	910/21K	530	910M/R55	109	920/R55LC	110	920M/56	104

ALPHANUMERIC INDEX

920M/R55	110	928AS	108	951TX/S	113	960T/I	117	998	123
920MC	98	928AS/C12	109	952	113	960T/L	117	999	123
920MC/C14	105	928B	107	952/S	114	960T/M	117	999/B6	123
920ME	101	928B/C12	108	952AS	114	960UC	118	999A	123
920ME/C	101	928ME	108	952FTX	114	960YP	117	999B	123
920ME/SB	101	929	109	952FTX/S	114	961BA	285	999C	123
920MQ/21	264	929/15	109	952L	114	961P6	119	999D	123
920MQ/22	264	929/21	109	953	114	961P6/S	119	999E	123
920MQ/55A	264	929/22	109	953/S	114	962	119	999G	123
920MQ/A	264	929/42	109	953TX	114	962M	120	9500TL	629
920MQ/C16	264	929/55	109	953TX/S	114	962P	120	9501TL	629
920MQ/PE	264	929/C8	109	955	114	963	120	9501TLD	629
920MQ/T	264	929/R55	110	956C	114	963BA	285	9502TL	630
920PE	100	930	110	956E	115	964	120	9503TL	630
920PE/AS	101	930/C	110	956F	115	964BA	285	9504TL	630
920PE/C	101	930/S	110	956L	115	964BA/L	285	9505TL	630
920PE/SB	100	932	110	957	115	965	120	9508TL	630
920PE-AS/SB6	101	932/S	111	959	115	965/S	120	9510	630
920PH	100	932HS	270	959R	115	965BA	285	9515M	633
920PH/SB4	100	933	111	960	115	966/C3	120	9516B	633
920RTX	101	933/S	111	960/22EP	117	966BA	285	9521	632
920RTX/SB	101	935	111	960/C6	117	966BA/V	285	9521OB	633
920TX	101	935/S	111	960/D	117	969B	120	9522A	637
920TX/C	101	935K	530	960A	115	969/C5	120	9523A	637
920TX/C17	107	937	111	960AD/TP2	167	970B	120	9524SC	635
920TX/L-SB4	101	937/S	111	960AVE	117	970C	121	9525/B	632
920TX/SB	101	937BA	285	960AVL	119	970EA	120	9525/N	632
920U	100	937K	530	960BT	115	970EB	120	9525BB	632
920U/SB13	100	940	111	960BT/B	115	970OT	121	9525F	632
920U/SB4	100	941	111	960CMB	117	970Q	120	9525TL	632
920XZN	102	941/S	111	960CMB/R2	117	971/C8	121	9526P	637
920XZN/LS	102	942BX	112	960CMD	118	971TSP	121	9526RMN	637
920XZN/SB12	102	942BX/S	112	960CMD/R1	118	973	121	9527 6T	637
920XZN/SB7	102	943BX	112	960EPC	118	978	121	9527MUG	637
921BA	284	943BX/D	112	960EPC/L	118	979	121	9528B	634
921BA/15	284	943BX/DG	541	960E-PI/P	118	982	121	9533N	630
921BA/21	284	943BX/DG	541	960F	115	984	121	9534B	631
921BA/22	284	943BX/S	112	960G	115	985/B7	121	9534W	630
921BA/25	284	943BXX	530	960H/C4	116	985F	122	9537TL	631
921BA/42	284	943FL	112	960KC-M8/M9/M10	118	985M	121	9539CB	633
921BA/50	284	943FL/S	112	960KPC	118	986 48	122	9541BIKE	632
921BA/R50	284	943MQ	265	960L	115	986 78	122	9541F	632
921BA-AS	284	943MQ/BG	541	960M	116	986PT	122	9541S	632
926BA	284	943MQ/S	265	960P	118	987	122	9542AL	634
926BA/22	285	944BX	112	960PI	119	987AR	122	9542AT	634
926BA/42	285	944BX/D	112	960PI/C19	119	987P	122	9542C	633
926BA/50	285	944BX/DG	541	960PI/S	119	988/K4	122	9542G	634
926BA/R50	285	944BX/S	112	960PMC	119	989	122	9542GW	634
928.../C12	108	949	112	960RPI	119	989A	122	9542M	633
928/15	108	949/S6	112	960S	116	990	122	9542S	634
928/16	108	950	113	960SL	116	991	122	9543C	634
928/20	108	950/S	113	960SN	116	992	122	9544C	631
928/21	108	951	113	960T/A	116	993	122	9547	637
928/22	108	951/S	113	960T/B	116	993G	123	9547T	635
928/25	108	951/SP	113	960T/C	116	993MQ	265	9547WSK	635
928/36A	108	951AS	113	960T/C11	116	993PL	123	9548G	635
928/42	108	951AS/S	113	960T/D	116	994	123	9548KB	635
928/55	108	951BA	285	960T/E	116	994MQ	265	9549BP	637
928/R55	110	951K	530	960T/F	116	994PL	123	9549C	637
928/R55X	110	951MQ	265	960T/G	116	994TF	123	9561V	635
928A	107	951TX	113	960T/H	117	996	123	9561V 2,5	635

ALPHANUMERIC INDEX

9561VV	635	9722	501	C23SC	326	C45AS2	408	C55M8	385
9561VV 2,5	635	9724	501	C23ST	326	C45C7	405	C55MA	386
9562P12	397	9726	501	CD23S	325	C45CORNER/W	407	C55MDO	386
9562P2	397	9729	501	C24S/5	327	C45CORNER/X	407	C55MP	392
9557J 2.0	631	9738	501	C24S/6	328	C45LMP	409	C55MS	387
9557J 3.0	631	9740	502	C24S/7	329	C45M5	405	C55P/2MDX-SX	388
9557N	632	9741	502	C24S/8	330	C45M7	405	C55P/MCD	388
9559	635	9742	502	C24SA/6	331	C45M7A/W	404	C55PB/3	375
9559/30MT	635	9743	502	C24SA/7	332	C45M7A/X	403	C55PFA-0,8	390
9562P2	639	9744	502	C24SA/8	333	C45MA	406	C55PFA-1,0	388
9562P12	639	9745	502	C24SA-XL/7	334	C45MS	406	C55PM	388
9562T2	639	9752	502	C24SA-XL/8	335	C45PF	407	C55PM/M0,8	390
9562T3	639	9801L	499	C24SA-XL/9	336	C45PM	408	C55PRO B/2	376
9562TB	639	9802M	499	C24SL	338	C45PW/2-1,3MT	404	C55PRO B/2,8	377
9563G	636	9803H	499	C24SL-CAB	338	C45PW/3-2,0MT	404	C55PRO B-D4	378
9563U	637	9811L	499	C25	339	C45PX/2-1,3MT	404	C55PS	391
9565BBQ	636	9812M	499	C27S	340	C45PX/3-2,0MT	404	C55PSE	391
9565ICE	636	9813H	499	C28	341	C45SL	406	C55PT0,8x0,6	390
9565K	636	9821L	500	C30S	342	C45SS	406	C55PT1,0x0,6	389
9565S	636	9822M	500	C35/6G	343	CA49-G	360	C55PTE-0,8	390
9565T	636	9823H	500	C35/7G	343	CX49-G	360	C55PTE-1,0	389
9569MS	638	9831L	500	C35/8G	344	C50S	361	C55RB	381
9569MS-2	638	9832M	500	C35/9G	344	C51	361	C55STR	397
9569P	638	9833H	500	C37/6	345	CP51	362	C55T3	387
9569S	638	9851	501	C37/7	346	CB52	362	C56	368
9572MB	630	9881U	502	C37/8	347	C54S	364	C56B	368
9574B	632	9882R	502	C37A/7	348	C55	374	C56M	369
9574O	632			C38	350	C55/1PF	390	C56P O	363
9577M	636			C38C	351	C55/2PM	389	C56PL O	363
9579C	636			C38L	350	C55/PF	388	C56W	368
9580S	631	C04TSS-7	279	C38L A	350	C55/PL-1,024	381	C57SA	365
9586K	637	C4 - 2104	317	C38T	351	C55A1	394	C57SB	366
9587 9x14	638	C5 - 2105	317	C39/6	352	C55A1/R42	394	C57SC	366
9587 13x21	639	C5S	317	C39/7	353	C55A2	395	C57SD	365
9588/10PI	639	C6T - 2106	318	C39/8	354	C55A2/R70	395	C57SP	367
9588M	638	C7 - 2107	318	C39MD	356	C55AB	375	C58B	369
9588S/10...	639	C8 - 2108	318	C39SM	356	C55AC	392	C58M	369
9589A/36	639	C9 - 2109	318	C39T	352	C55AE	391	C58M/PA	370
9589B/36	639	C9/RT	318	C41H	357	C55AT1	396	C58P	367
9590B	635	C10 - 2110	318	C41H/CE	358	C55AT2	396	C59A	370
9592B/C50	637	C10S - 2110S	318	C41MS	358	C55B PT/2	381	C59B	371
9592B/P	638	C11 - 2111	319	C41S	357	C55B PT/2,8	381	C59C	371
9592M/50	638	C12 - 2112	319	C42H	358	C55B/1	393	C63 G/C	591
9592MB	638	C13	319	C42MCH	358	C55B/2	376	C68	544
9595 C25	638	C14	319	C43	359	C55B/2,8	377	C68G	544
9595C	638	CP15	319	C45/AW	399	C55B/G	379	C88R/1	545
9595T	638	CP15L	319	C45/AX	399	C55B/GAA	379	C88SE	545
9593A	631	C16	320	C45/BPW-1,3	402	C55B/GAE	380	C88VE	545
9593M	631	CP17	320	C45/BPW-2,0	403	C55B/GDP	379	C99C-V3	323
9593S	631	CP17L	320	C45/BPX-1,3	402	C55B/GDS	379	C99M	324
9593W	631	C18	320	C45/BPX-2,0	403	C55B/GE	380	C99P	323
9594	637	C19	320	C45/BW	400	C55B/VS	381	C99PC	324
9596	638	C19L	320	C45/BX	399	C55B-D4	378	C99P-V3	324
9597P	634	C20	320	C45/CW	402	C55C	393	C99T	324
9598W	633	C22B	321	C45/CX	401	C55C7	382	C99T-V3	324
9598WHP	633	C20L	320	C45/DW	400	C55C8	383	C99V1	322
9599CB	633	C20TSS	278	C45/DX	400	C55CS	385	C99V2	322
9599CB-W	633	C22P	321	C45/EW	401	C55KAI	392	C99V3/2C	323
9710	501	C22S	325	C45/EX	401	C55KAS	392	CB/2	497
9712	501	C20TSS	321	C45/W	398	C55M2	383	CP	409
9720	501	C22W	321	C45/X	398	C55M4	384		
		C23S	325	C45AS1	408	C55M7	384		

ALPHANUMERIC INDEX

G, K

GM 496
KIT/GPS 496

M

M01 471
M02 471
M05 471
M06 471
M13 471
M25 471
M30 471
M31 471
M33 471
M38 471
M39 472
M40 472
M44 472
M45 472
M46 472
M49 472
M50 472
M52 472
M53 472
M55 472
M60 473
M62 473
M63 473
M65 473
M69 473
M75 473
M78 473
M79 473
M82 473
M83 474
M85 474
M86 474
M91 474
M92 474
M94 474
M96 474
M100 474
M105 475
M108 475
M110 475
M112 475
M115 475
M120 475
M121 476
M125 476
M126 476
M127 476
M128 476
M129 476
M133 476
M134 476
M135 476

M136 476
M137 477
M145 477
M153 477
M161 477
M162 477
M166 477
M170 477
M172 477
M174 477
M180 477
M195 478
M199 478
M202 478
M204 478
M208 478
M209 478
M213 478
M214 478
M216 478
M217 479
M218 479
M219 479
M223 479
M224 479
M226 479
M227 479
M230 479
M231 479
M234 480
M236 480
M237 480
M240 480
M264 480
M284 480
M285 480
M289 480
M292 480
M295 480
M305 480
M310 481
MB 496
MB12 481
MB37 481
MB38 482
MB39 482
MB44 482
MB45 482
MB46 482
MB47 482
MB56 482
MB59 483
MB58 483
MB65 483
MB63 483
MB64 483
MC10 481
MC12 481

P, S

PM/5C 409
PM/6C 409
PV 367
S42/17 497
S55/8 497
S55/12 497
S96T/8 497
S951/6 497
S952/10 497
S1719BM 497
SB 496
SGN 497
SPG11 - S1203/8 497
ST2P 497

T

T01 485
T05 485
T06 485
T13 485
T18 486
T19 486
T22 486
T23 486
T31 486
T33 486
T34 486
T40 486
T41 486
T45 486
T46 486
T48 486
T50 487
T52 487
T53 487
T55 487
T56 487
T57 487
T59 487
T63 487
T64 487
T65 487
T68 487
T73 487
T75 488
T76 488
T77 488
T79 488
T80 488
T81 488
T82 488
T83 488
T85 488
T91 488
T92 488
T99 489

T100 489
T101 489
T102 489
T103 489
T105 489
T106 489
T110 489
T112 489
T113 489
T121 489
T137 489
T135 490
T136 490
T138 490
T140 490
T144 490
T145 490
T146 490
T151 490
T153 490
T156 490
T157 490
T160 490
T161 491
T164 491
T167 491
T168 491
T170 491
T171 491
T172 491
T173 491
T175 491
T176 491
T177 491
T180 492
T183 492
T198 492
T199 492
T201 492
T202 492
T204 492
T205 492
T206 492
T207 492
T208 492
T209 492
T211 493
T213 493
T216 493
T221 493
T226 493
T227 493
T228 493
T231 493
T233 493
T234 493
T236 493
T239 493
T241 494
T250 494

T256 494
T259 494
T264 494
T270 494
T273 494
T281 494
T285 494
T284 495
T289 495
T291 495
T297 495
TSPP 497

V

VE1 496
VP1 - VP2 495
VP3 - VP4 495
VP-3SC 495
VP-LS 495
VP-LD 495
VP5 495
VP6 495
VPM0 485
VPM3 485
VPM7 485
VPM7-C 485
VPM8 485
VPM9 485



Beta

RSC 55

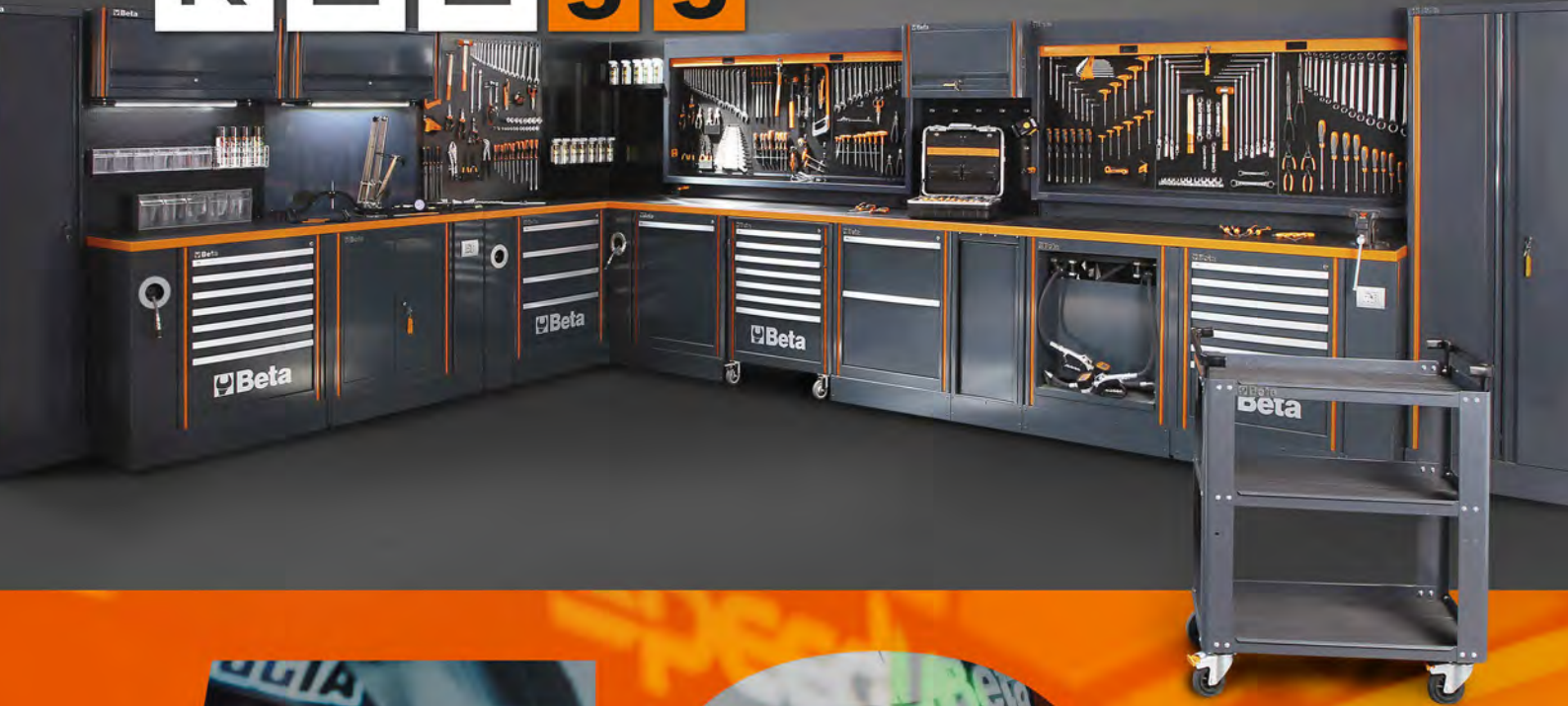

50 years in motorsports



Beta
GROUP



2020



Jorge Navarro
Moto2 World Championship

Partnership



998068900



www.beta-tools.com